



Features

- 8 Single-ended Analog Input Channels (16-bit Resolution)
- Support real Sample and Hold
- Max Sample rate: 200 kS/s
- Built-in I/O
 - AI: 8 Channels
 - DI: 4 Channels
 - DO: 4 Channels



Introduction

The PET-7H16M is a high speed data acquisition devices with a built-in Ethernet communication port for data transfer over a network, and includes 8 high-speed 16-bit single-ended Analog input channels (200 kHz sample and hold for all 8 channels), 4 Digital Input channels and 4 Digital Output channels. The module provides a programmable input range on all analog channels (± 5 V and ± 10 V), and the Digital Output can be set to output with short-circuit and overload protection. The PET-7H16M also provides 4 kV ESD protection as well as 2500 Vdc intra-module isolation.

	Software AD	External CLK AD	Pre-Trigger	Post-Trigger
Continuous Mode	1 ~ 30 kHz	1 ~ 30 kHz	-	-
N Sample Mode	1 ~ 200 kHz	-	1 ~ 200 kHz	1 ~ 200 kHz

System Specifications

Communication	
Ethernet Port	1 x RJ-45, 10/100 Base-TX
PoE	Yes
Security	ID, Password and IP Filter
LED Indicators	
System Running	Yes
Ethernet Link/Act	Yes
PoE Power	Yes
2-Way Isolation	
Ethernet	1500 Vdc
I/O	2500 Vdc
EMS Protection	
ESD (IEC 61000-4-2)	4 kV Contact for Each Terminal and 8 kV Air for Random Point
EFT (IEC 61000-4-4)	+/-4 kV for Power

Power	
Reverse Polarity Protection	Yes
Powered from Terminal Block	+12 ~ +48 Vdc
Consumption	2.6 W
Mechanical	
Dimensions (W x L x H)	76 mm x 120 mm x 38 mm
Installation	DIN-Rail or Wall Mounting
Enclosures	Metal
Environment	
Operating Temperature	-25 ~ +75 °C
Storage Temperature	-30 ~ +80 °C
Humidity	10 ~ 90 % RH, Non-condensing

I/O Specifications

Analog Input	
Channels	8 Single-ended
Resolution	16-bit
Sampling Rate	200 kS/s (Each Channel)
Bipolar Input (Programmable)	+/- 10 V, +/- 5 V
FIFO Size	2 k Sample
Accuracy	0.05 % of FSR
AD Trigger Mode (Programmable)	Software/External Clock Trigger / Digital Trigger (Post/Pretrigger)
Digital Output	
Channels	4
Contact	Wet Contact
Sink/Source (NPN/PNP)	Sink/Source
On Voltage Level	+5 V _{DC} ~ 30 V _{DC}
Off Voltage Level	1 V _{DC} Max.

Digital Output	
Channels	4
Type	Isolated Open Collector
Sink/Source(NPN/PNP)	Sink
Load Voltage	+5 V _{DC} ~ 30 V _{DC}
Load Current	100 mA
Short-circuit Protection	Yes
Overload Protection	1.3 A
External Clock Trigger / Digital Trigger	
Trigger Pulse Width	1.5 μs Min.
Trigger Type	Falling edge
On Voltage Level	+5 V _{DC} ~ 5.5 V _{DC} @ 15 mA
Off Voltage Level	< 0.8 V _{DC}

Pin Assignments

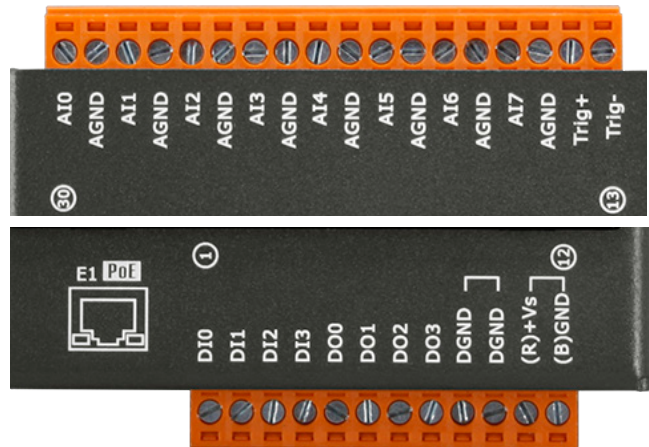

Wire Connections

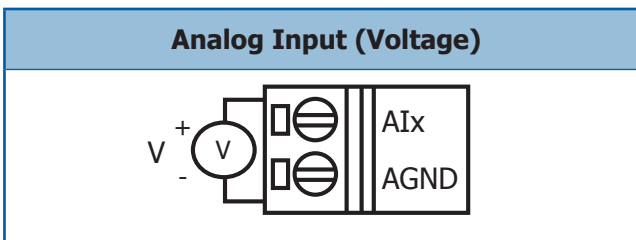

Digital Input/Counter	ON State Readback as 1	OFF State Readback as 0
Wet Contact (Sink)		
Digital Output	ON State Readback as 1	OFF State Readback as 0
Open Collector (Sink)		
External Clock Trigger/ Digital Trigger	ON State Readback as 1	OFF State Readback as 0
Open Collector (Sink)		

Features

1 Data transmission mode

1. Continuous transmission (Maximum sampling rate of 30 kHz per channel)
After starting A/D acquisition, data is continuously transmitted to the Host PC.
2. After collecting N data samples, the data is transferred to the Host PC (Maximum sampling rate of 200 kHz per channel)
 - a. After starting A/D acquisition, the data will be temporarily stored in the memory on the PET-7H16M module, and wait until a command is received from the Host PC, before transferring the collected data to the Host PC.
 - b. The memory capacity allows temporary storage of up to 30 million data samples, Storage time:
 - i. 125 seconds at a sampling rate of 30 kHz.
 - ii. 19.6 seconds at a sampling rate of 200 kHz.



2 A/D trigger mode

1. Software AD Data Acquisition mode

The A/D acquisition parameters are configured via a command from the Host PC. The continuous A/D acquisition or the acquisition of N data samples begins after the command is triggered.

2. External Digital Signal Event Trigger mode

The A/D acquisition parameters are configured via a command from the Host PC, and then triggered via an external electrical signal. The A/D acquisition of the N data samples is then started.

3. External Clock AD Conversion Data Acquisition mode

The speed of the A/D acquisition and the amount of data acquired are controlled by external electrical signals. A falling edge for each output waveform triggers an AD conversion.

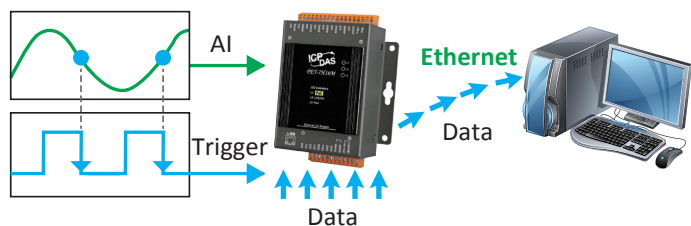

External Clock Signal Synchronization A/D Acquisition Mode

3 External Digital Signal Event Trigger mode

A/D acquisition is performed in external digital event trigger mode (triggering the electrical signal is the falling edge trigger). The maximum sampling rate per channel is 200 kHz, and A/D acquisition of N data samples is performed. The acquisition mode can be categorized into two types:

1. Pre-Trigger (acquisition of N data samples)

The A/D data is continually collected and is temporarily stored in the memory on the PET-7H16M until the trigger signal is received. Once the trigger signal is received, the collected N data samples are then transferred to the Host PC.

2. Post-Trigger (acquisition of N data samples)

In this mode, the A/D acquisition of the N data samples is started once the trigger signal is received.

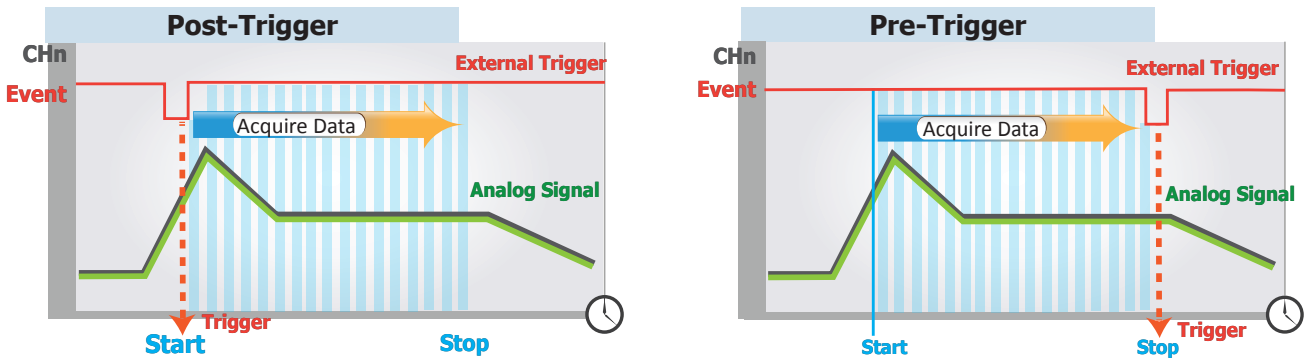

4 A/D Synchronization Trigger Between Multiple Modules

The A/D acquisition parameters are configured via a command from the Host PC, and are triggered by an external digital signal event, the A/D acquisition of N data samples, or A/D acquisition via the synchronization of an external clock signal.

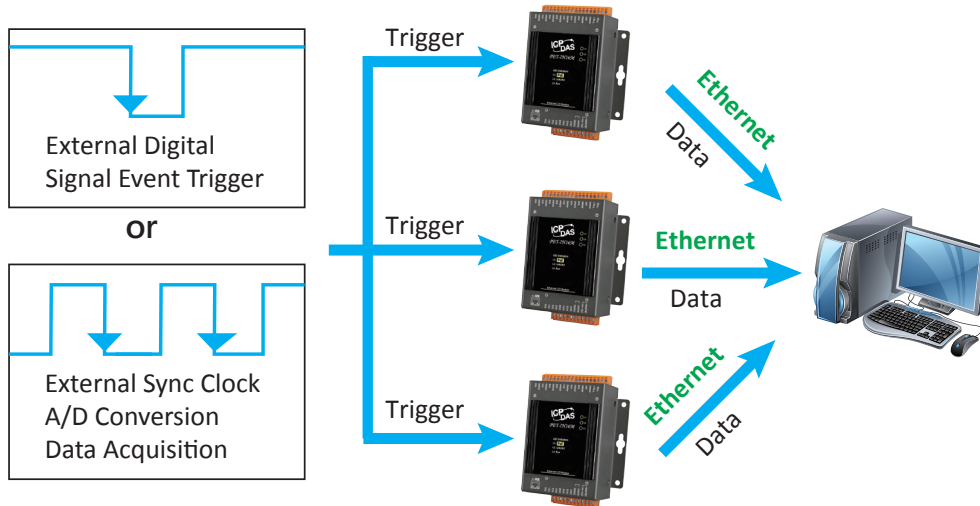

5 PC Software Support

1. VC, C#, VB.NET API and Demo
2. LabVIEW Toolkit and Demo

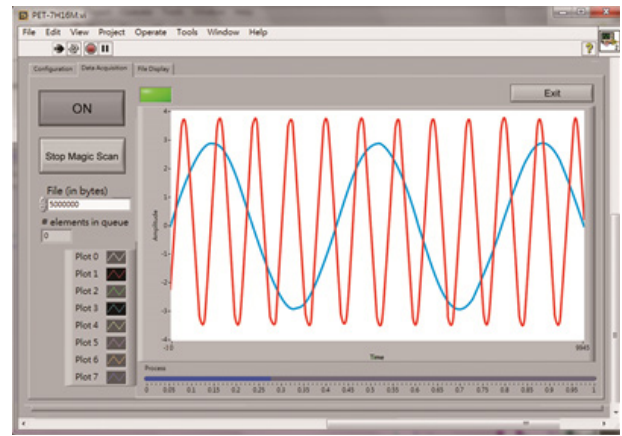
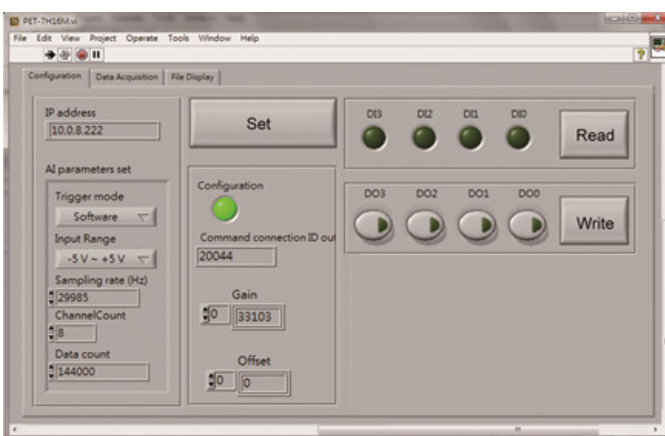

Ordering Information

PET-7H16M Ethernet High Speed Data Acquisition Module with 8 x AI, 4 x DI, 4 x DO Channels (RoHS)