



**Your experts for
safety, facility
and equipment
identification**

Product Catalog

Expert solutions

backed by more than

100 years



BRADY

It takes a lot to get it right.

To be a company that lasts more than

100 years by continually evolving and growing to meet the needs of our markets and customers. Brady has not only survived since it was founded in 1914 — **it has thrived.**

Our first-to-the-market and best-in-the-market approach led us to receive hundreds of patents over the years and truly shape an industry.

Simply put, **we do what others don't in ways they can't.** We offer innovative products backed by years of research and development. Beyond our quality products and reliable solutions, we add value for our customers through strong partnerships and a commitment to solving important problems.

Brady offers you solutions to help increase safety, security, productivity and performance throughout your facility — everything from printing systems, software and high-performance labels, to facility signs, safety devices, expert safety services and more.

▶ **Let us show you what we have to offer**



Table of Contents

Key Business Issues	4
Safety Services	22
Benchtop Printers	26
Sign and Label Printers.....	26
B30- and B33-Series Supplies	36
BBP85.....	76
BradyJet Printers.....	84
Portable Printers	102
BMP21	104
BMP41	108
BMP51	114
M611 and BMP61.....	126
BMP71	152
Software	176
Lockout Tagout	180
Padlocks	186
Lockout Tags.....	202
Valve Lockouts.....	210
Electrical Lockouts.....	214
Lockout Kits	230
Absorbents and Spill Control	248
Absorbents	254
Granular and Spill Containment	274
Absorbent Kits	281
Facility Marking and Tapes	294
Floor Marking Tape	295
Lean / 5S Marking Tape	300
Barricade Tape and Floor Stands.....	304
Security.....	310
PPE Dispensers	314
Tags	318
Inspection Tags.....	318
Facility Tags	327
Valve Tags.....	336
Pipe Markers	342
Pre-Printed Labels	362
HazCom / GHS Labels	362
Arc Flash Labels	380
Facility / Machine Labels.....	386
Numbers and Letters	398
Signs	402
Safety Signs	412
Traffic Control Signs	560
Sign Accessories	578
Custom Signs.....	582
Sign Legend Index.....	588
Index	610
Part Number Index.....	610
Product Index	652



Visual Workplace and Lean Manufacturing

BradyID.com/visualworkplace

Key Business Issues

Visual Workplace

Visual Workplace is a lean concept that emphasizes putting critical information at the point of use for improved efficiency and safety. Visual systems and devices play a critical role in many of the most popular lean tools, including: 5S, standard work, total productive maintenance, quick changeover and kanban (pull production).

Did you know waste accounts for 95% of all costs in non-lean manufacturing environments?

Waste is often caused by information gaps — employees simply not knowing the best way to get the job done. Instead, time is wasted searching, waiting, retrieving and redoing work.

Did you know 75% of knowledge is gained through visuals?

An effective visual workplace tells employees exactly what procedural and safety information they need to know when and where they need it.

Did you know lean manufacturing can lead to a 40% increase in productivity?

When visuals help to make processes more efficient, reduce equipment downtime, keep employees safe and facilities more organized, then operations become more productive.



What info should be posted?

Any critical information should be embedded right where your employees work — on equipment, shelves and floor surfaces. When this information is available at a glance, it is clearly visible to employees, readily understood and can be consistently adhered to.



Visual Workplace Tapes
(page 295)



Lean Manufacturing can lead to a 40% increase in productivity. Learn more with our free guide-book.

▶ Download at BradyID.com/visualworkplace

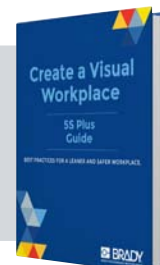

Visual Workplace and Lean Manufacturing

BradyID.com/visualworkplace

Key Business Issues



Stocking / organization labels



Inventory level indicator labels



Kanban cards / labels



Procedures



One-point lessons and labels



Safe state / gauge labels

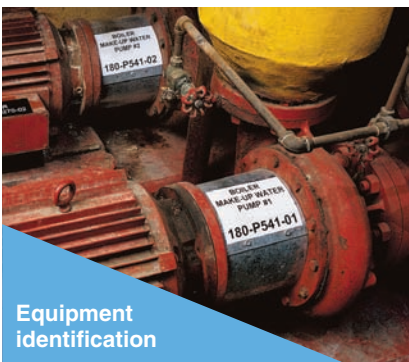

Equipment identification

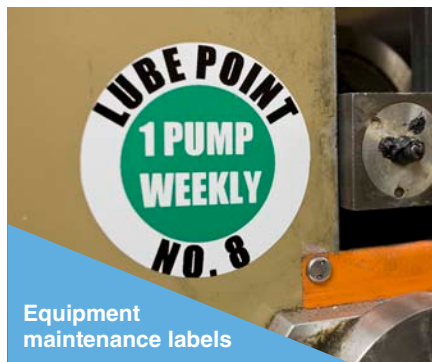

Equipment maintenance labels



Replacement part labels



Safety signs

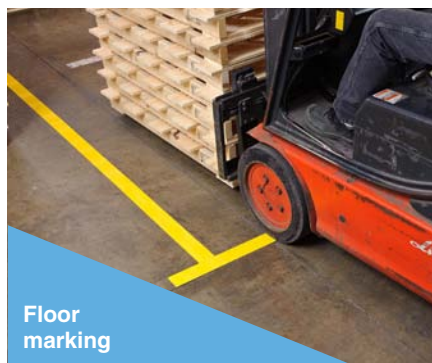

Floor marking



And more

Visual Workplace and Lean Manufacturing

BradyID.com/visualworkplace

Brady visual workplace solutions

Key Business Issues



Sign and Label Printers

Brady sign and label printers are essential tools for creating a visual workplace, making it easy for you to create visuals on-site and on-demand.

Benchtop printers (page 30)
Color Inkjet printers (page 84)



Brady Workstation Safety and Facility Identification Suite (page 177)

Keep your facility safe and compliant with the Safety and Facility Identification Suite. This group of label design apps makes it easy to create custom signs, labels, pipemarkers and visual safety guidance for your facility.



ToughStripe® Max Floor Marking Tape (page 295)

For durable floor marking that helps establish a safer, more organized and more productive facility, Brady offers ToughStripe Max floor marking tape.



Brady Inspection Timer (page 318)

LED lights on the Inspection Timer visually indicate how much time you have left before the next inspection. After you've finished your inspection, reset it so you're ready for the next one. Timing options include 7 days, 30 days, 90 days, 6 months or a year.



Pipe Markers (page 342)

Color-coded pipe markers can be used to instantly tell workers everything they need to know about pipe contents, directions of flow and level of safety.



Absorbents and Spill Control (page 264)

An effective spill control program can create a safe and productive work environment. Brady SPC products provide effective clean-up of spills and leaks throughout your facilities.

Uncover visual workplace opportunities throughout your facility with our free download *50 Lean Visuals*

▶ Download at BradyID.com/visualworkplace



Lockout tagout: A critical safety regulation

Lockout tagout is an important safety component that is critical to safeguarding workers around the machinery and equipment they operate, service and maintain. This important safety practice involves de-energizing electrical circuits, closing valves, neutralizing extreme temperatures and securing moving parts so hazardous energy isn't re-introduced while equipment is being serviced.

An effective lockout tagout program is most successful when it includes the complete safety picture — locks, tags and devices — as well as proper lockout procedures, program documentation, employee training, periodic inspections or other procedural elements.

Benefits of a lockout tagout program

- **Saving lives:** Preventing an estimated 250,000 incidents, 50,000 injuries and 120 fatalities annually
- **Cutting costs:** Significantly decreasing lost employee time and insurance costs
- **Improving productivity:** Reducing equipment downtime



Regulatory requirements

OSHA 29CFR 1910.147 — Control of Hazardous Energy

This standard addresses the practices and procedures necessary to disable machinery or equipment, thereby preventing the release of hazardous energy while employees perform servicing and maintenance activities.

OSHA 29CFR 1910.333 — Electrical Safety

Safety-related work practices shall be employed to prevent electric shock or other injuries resulting from either direct or indirect electrical contacts, when work is performed near or on equipment or circuits which are or may be energized.

ANSI Z244.1 (2016) — Lockout Tagout and Alternative Methods

A voluntary national consensus standard that represents several industry hazardous energy control best practices and also promotes greater flexibility through the use of alternative methods based on risk assessments and application of the hazard control hierarchy.

Lockout tagout is the fifth most cited OSHA violation, with 2,944 violations during fiscal year 2018

Top violations involve:

- | | |
|-------------------|-------------------------------------|
| 1910.147(c)(4)(i) | Requirements for general procedures |
| 1910.147(c)(1) | Program requirements |
| 1910.147(c)(6)(i) | Inspecting procedures |
| 1910.147(c)(7)(i) | Training requirements |
| 1910.147(d) | Notifying affected employees |

**Go beyond compliance with the
Expanded Guide to Lockout Tagout**

▶ Download at BradyID.com/lockouttagout



Six essential elements of lockout tagout



1. Program and policy

A written lockout document establishes and explains the elements of your program. It's important to take into account not only OSHA's guidelines, but also custom requirements for your employees that ensure they can understand and apply the program to their workday.



2. Machine- or task-specific procedures

Lockout procedures should be formally documented and should easily identify the equipment covered. They should also detail the specific steps necessary for shutting down, isolating, blocking and securing equipment to control hazardous energy, and include steps for the placement, removal and transfer of lockout tagout devices.



3. Identifying and marking energy isolation points

Locate and identify all energy control points, including valves, switches, breakers and plugs, with permanently placed and standardized labels or tags.



4. Training and periodic inspections and audits

Train authorized, affected and other employees, communicate processes and conduct periodic inspections. Training should include OSHA requirements and specific program elements, such as your machine-specific procedures.



5. Proper lockout devices

Provide employees with the necessary devices to keep them safe. There are many products on the market, and selecting the most appropriate solution for your application is the key to lockout effectiveness. It's important to document and use devices that best fit each lockout point.



6. Sustainability

Annually review, revise and update your program and procedures to create a safety culture that proactively addresses lockout tagout. This allows your company to focus on maintaining a world-class program, instead of starting from scratch each year and reacting only when something goes wrong.

Brady lockout tagout solutions



new

SafeKey Lockout Padlocks (page 188)

Innovatively designed SafeKey Lockout Padlocks provide up to 700% more unique key codes than traditional safety padlocks. New design features a linear locking mechanism that provides ultimate key precision and advanced key security in your lockout tagout program.



new

Pendant Control Safety Cover (page 226)

Control access to the buttons on your hoist or crane control with the Pendant Control Safety Cover. This device features rigid sides and is expandable to fit 4 to 18 in. pendant controls.



new

BatteryBlock™ Battery Cable Lockout for Commercial Vehicles (page 228)

Prevent an accidental battery connection with the BatteryBlock Battery Cable Lockout. Non-conductive post and cover keep battery secured throughout your maintenance.



new

SlimView™ Group Lock Box (page 198)

Save space during lockout tagout projects with the SlimView Group Lock Box that features an innovative recessed door that allows padlocks to hang straight.



new

RipTag™ Safety Tag Roll (page 204)

Get a complete solution for your tagging needs with the RipTag Safety Tag Roll that includes zip ties for easy attachment. Rip off the tags you need now, keep the others on the roll for when you need them later.



new

Pipe Blind Flange (page 210)

Keep your facility safer and compliant with Brady's Pipe Blind Lockout. This device is a fast, easy and secure lockout for pipe blinds.

Brady's Professional Lockout Services (page 23)

We've partnered with clients for more than 100 years to help them solve their safety issues. Our team will help you create the lockout program you've been working toward through a wide range of solutions that help you solve both your compliance and your behavioral safety hurdles.



Arc Flash Safety

What is arc flash and what causes it?

An arc flash is a short circuit through air that flashes from one exposed live conductor to another conductor or ground. This electrical fault can create a dangerous release of energy, including thermal energy, acoustical energy, pressure wave or debris.

There are many ways an arc flash can occur, including:

- Close proximity of a high-amp source to a conductive object
- Dropping a tool or creating a spark
- Breaks or gaps in insulation
- Failing equipment due to use of substandard parts, improper installation or even normal wear and tear
- Dust, corrosion or other impurities on the surface of the conductor

Who's responsible for labeling?

Arc flash labeling is the responsibility of the employer, not the manufacturer or installer of the equipment.

What needs to be labeled?

Labeling is required for any piece of electrical equipment that is likely to require examination, adjustment, service or maintenance while energized, creating the potential for an arc flash incident to occur.

Any modifications or renovations to electrical equipment that changes data on the label requires an updated arc flash risk assessment and label.

Where should the label be placed?

Markings must be in a location that is clearly visible to workers before they may be exposed to any potentially dangerous live parts. Typically, the label is placed outside the panel or enclosure door.



Did You Know?

Anything above 50V that could be worked on while energized, resulting in exposure to electrical hazards, requires an arc flash label.

Examples include, but are not limited to:

- Switchboards
- Industrial control panels
- Panel boards
- Meter socket enclosures
- Motor control centers

▶ Download our free e-book at BradyID.com/arcflash



NFPA 70E Standard for Electrical Safety in the Workplace

OSHA cites and fines employers for failure to protect employees from the dangers of arc flash under regulation 29 CFR 1910.333(a). The National Fire Protection Association (NFPA) details how to comply with this regulation through the NFPA 70E standard.

According to the NFPA 70E standard, there are six primary responsibilities that facilities must meet, including:

1. Training for employees
2. Written safety program in place that is actionable
3. Personal protective equipment (PPE) available for employees
4. Insulated tools
5. Arc flash hazard degree calculations
6. Properly labeled equipment

Most recent updates (2018)

The NFPA 70E gets updated every three years. Some of the most recent updates include:

- Updated training and retraining requirements
- Revision to arc flash warning label content
- Elimination of the PPE hazard category 0
- Elimination of prohibited approach boundary
- Additional boundary requirements
- Revisions to selecting appropriate PPE
- Minor terminology changes (such as work shoes now referred to as footwear)

Brady arc flash labeling solutions



Arc flash services (page 24)

Brady understands the importance of electrical safety as a whole and has licensed engineers who understand not only arc flash safety, but also the first-hand impact of arc flash risk. We work with your team to best protect your employees based on your custom facility and program requirements.

- **Arc Flash Risk Assessment**

A Brady safety electrical engineer completes your assessment, provides you with a detailed assessment report, including your single-line diagram, and installs the correct arc flash labels.

- **Arc Flash Audit**

Let our electrical engineers perform your arc flash audit and ensure your assessment is up to date and compliant.

- **Arc Flash Safety Training**

This custom approach to training incorporates both the NFPA regulation and your company-specific arc flash requirements to ensure participating employees can apply their knowledge.



Print your own labels (page 44)

Create and print customized arc flash labels when and where you need them with an on-demand label printer. When you're working on a project, you can stop handwriting your labels, and print all the labels you need in batches. You also avoid the hassle of having to select, order and wait for pre-printed labels to arrive.



Pre-printed labels (page 384)

Pre-printed arc flash labels with the arc flash PPE category and a list of the required PPE relieve the employer from having to hand-write this information. As with the check box labels, a version for both arc flash and shock hazards is available.

GHS Hazard Communication

OSHA's Hazard Communication Standard directly affects all areas of chemical labeling and specifies mandatory employee training. This means you need to know exactly what the Global Harmonized System (GHS) is and how it affects your business.

What is GHS?

GHS is an international system that the United Nations created for the unified classification and labeling of chemicals. GHS has been fully or partially implemented in about 67 countries and in 2012, OSHA updated its HazCom Standard to align with GHS in order to support global efforts to standardize chemical labeling.

Benefits of GHS

The updated HazCom standard covers more than 43 million workers who produce or handle hazardous chemicals in more than five million workplaces across the country. GHS is expected to prevent more than 500 workplace injuries, illnesses and 43 fatalities annually. In addition, it could save businesses in the U.S. more than \$475 million in productivity improvements.

Five steps to GHS

1. Develop a written HazCom plan that includes a summary of the hazardous chemicals and training.
2. Inventory and make a list of all hazardous chemicals used throughout your facility.
3. Establish and maintain a complete library of all Safety Data Sheets (SDS) so employees have immediate access to them at all times.
4. Label all hazardous storage containers, pipes and tanks to clearly communicate hazards to your employees.
5. Train and communicate the elements of your HazCom plan to your workforce.



Regulations

In the United States, OSHA is enforcing GHS by adopting it into its Hazard Communication Standard (CFR 1910.1200). It is focused on ensuring chemical safety in the workplace by requiring chemicals to be labeled and chemical hazards to be identified in a way that is easily understood by workers. It entails:

- Chemical manufacturers and importers must classify the hazards of the chemicals they produce or import, and prepare labels and safety data sheets to convey the hazard information to their downstream customers
- Employers with hazardous chemicals in their workplaces must provide labels and SDSs for their hazardous chemicals, and train exposed workers to understand the chemical hazards.

OSHA HazCom violations

HazCom was #2 on OSHA's Top 10 list of most frequently cited standards for fiscal year 2017.



Learn more with the *Streamlined Guide To GHS*

▶ Download at BradyID.com/ghs



Brady GHS labeling solutions



Print your own labels (page 42)

Create and print customized GHS labels when and where you need them with an on-demand label printer. Many of our featured GHS label printers have an easy-to-use touchscreen interface and built-in GHS label creation applications that make creating GHS labels simple.

Brady Workstation GHS App (page 176)

Creating GHS labels is now surprisingly simple. We've streamlined the process so you can easily enter the data once from your SDS sheets into pre-formatted GHS label layouts with approved GHS symbols, then create and print any size at any time. Need labels with multiple languages? Those are also supported, too.



Pre-printed GHS pictograms (page 371)

Printing your own GHS labels but can't get the pictograms you need? Grab a roll of Brady's pre-printed GHS pictogram labels. These are a great way to supplement mono-color label printers without investing in a brand new label printing system.



GHS training (page 368)

Looking to implement or sustain your GHS training program? Make sure you have the right materials for the job. Our training kit features videos, an instructor's guide, employee quizzes, presentation slides and employee handbooks.

Brady's partnership with MSDSonline.com

Without a comprehensive online system to save and manage SDS information, users would have to input data manually in order to print the needed chemical labels. Brady's partnership with MSDSonline allows you to quickly populate and print your labels — saving you time and ensuring information is input correctly onto the label.



MSDSonline.com

Helps improve the real time management of chemical products and safety data sheets.



Brady Printers

Reliable label printing with a range of durable materials for specific applications or regulation requirements.



MSDSonline customers use SDS from their system to create labels that are formatted with the GHS label elements and can be printed right to Brady label printers.

Slips, Trips and Falls

BradyID.com/slipstripsfalls

Slips, Trips and Falls

Slips, trips and falls occur when there is too little friction or traction on a walking surface, when a foot or lower leg hits an object while the rest of the body continues to move, or when the center of balance is lost, resulting in a descent to the floor, against an object or to a surface at a lower level than the original surface.¹ These incidents are often caused by slippery, irregular or uneven surfaces, obstacles on the floor or uncovered / unidentified hazard areas.

Hazards relating to slips, trips and falls are frequently top offenders on OSHA's top 10 violation lists. In 2015 alone, slips, trips, and falls were tied to three of the top ten violations, and two of the top three. These violations included hazards relating to fall protection (#1), scaffolding (#3), and ladders (#7).²

Impacts of slips, trips and falls

Slips, trips and falls can have a costly impact on the safety and productivity of your facility:

- One of the leading causes of unintentional injuries in the U.S., accounting for approximately **8.9 million emergency room visits**³
- Lead to over **17% of all disabling occupational injuries**⁴
- Cause **1 in 6 lost time injuries**⁵
- Result in **95 million workdays lost** per year⁵
- Cost an average of **\$20,000 per incident**⁶



Regulations

OSHA 29 CFR 1910.22

Walking/Working Surfaces. This standard supports worker safety by keeping workplaces clean and safe from hazards, including keeping facilities clean, dry and orderly, providing dry standing surfaces, permanently marking aisles, passageways, and more.

ANSI A1264.2-2012

Provision for the Slip Resistance on Walking / Working Surfaces. This sets forth provisions for protecting persons where there is potential for slips and falls as a result of surface characteristics or conditions.

10 steps to avoid slips, trips and falls

1. Assess your workplace
2. Mark aisles and passageways
3. Provide traction on slippery surfaces
4. Improve stair safety
5. Mark emergency evacuation routes
6. Post safety signs and labels
7. Warn of temporary hazards
8. Inspect scaffolds and ladders
9. Control and clean oil and spills
10. Train employees

Learn more about slips, trips and falls and how to prevent them with this free guide.



Download at
BradyID.com/slipstripsfalls

1. OSHA. (2007). Slips, Trips and Falls Identification and Prevention. Retrieved from: https://www.osha.gov/dte/grant_materials/fy07/sh-16625-07/slipstripsfalls.ppt

2. ISHN. (2015). OSHA's top 10 violations for 2015 announced at NSC Congress and Expo. Retrieved from: <http://www.ishn.com>

3. National Safety Council. (2011). Slips, Trips and Falls Fact Sheet. Retrieved from: http://www.nsc.org/NSCDocuments_Advocacy/Fact%20Sheets/Slips-Trips-and-Falls.pdf

4. OSHA. (2007). Slips, Trips and Falls Identification and Prevention.

5. Smith, S. (2013, July 15). The High Costs of Slips, Trips and Falls. Retrieved from EHS Today.

6. National Floor Safety Institute. (2015). Quick Facts. Retrieved from NFSI.org: <http://nfsi.org/nfsi-research/quick-facts/>

Brady slip, trip and fall solutions



Safety Signs (page 411)

Slip, trip and fall hazard signs allow you to bring awareness to potential dangers in your facility. These signs provide a permanent visual warning in areas where slips, trips and falls are more likely to happen.



Absorbent Safety Mats (page 264)

BrightSorb® Safety Absorbents provide an absorbent and brightly colored warning in one convenient product.

Additionally, our absorbent products extend out to mats and rugs, allowing you to address foot traffic that may bring snow, water or ice into your workplace.



Floor Marking Tape (page 295)

Make your facility cleaner, more efficient, more visual and safer with ToughStripe® Floor Marking Tape. This tape helps you identify aisle ways, tripping hazards, storage areas and more.



Floor Stands (page 308)

Similar to safety signs, floor stands provide a strong visual that can be temporarily placed to identify potential slip, trip and fall hazards. By placing the sign on, over or in the way of the hazard, you can naturally create awareness and even divert foot traffic from entering potentially dangerous areas.

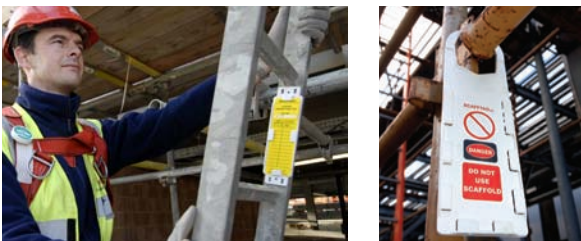

Ladder and Scaffold Tags (page 320)

Our scaffold tags comply with OSHA's regulations and help warn employees when scaffolding is not safe, being taken down or has been found defective.



Anti-Slip Tape and Cleats (page 302)

Anti-slip tape and cleats help protect your employees from accidental slips, trips and falls by providing additional traction. Printed anti-skid products are designed for most surfaces and can provide a visual warning.

Leak, Drip and Spill Control

BradyID.com/s36

Key Business Issues



Leak, Drip and Spill Control

When a spill occurs, having a proper spill control program that enables quick and effective response can not only help to protect the environment, but also support a safe and productive workplace for your employees.

Brady SPC supplies products that help you comply with EPA and OSHA regulations. Why does that matter? Because our goal is to help support high levels of productivity and to limit equipment downtime. The cost of non-compliance around this area of regulation can have devastating effects on a business's reputation and financial performance.



Still using granular? View our [Cost Savings Calculator](#) to see how you can save. (page 254)

What is a Spill Prevention Control and Countermeasure (SPCC) Plan?

A SPCC plan is a facility-specific, comprehensive plan outlining both the containment and countermeasures implemented to prevent a spill from occurring and a series of response procedures in the event that one does. The SPCC plan addresses the following three areas:

- Operating procedures that prevent spills
- Control measures installed to prevent a spill from reaching the environment
- Countermeasures to contain, clean up and mitigate the effects of an oil spill that reaches the environment



Having an SPCC plan in place is an essential step to help companies avoid the costly impact of non-compliance, including fines as high as \$25,000 per day per violation.

Need-to-know regulations

The following OSHA and EPA regulations protect your employees and the environment:

29 CFR 1910.22(a)(2)

– Walking-Working Surfaces

The floor of every workroom shall be maintained in a clean and, so far as possible, a dry condition. Where wet processes are used, drainage shall be maintained, and false floors, platforms, mats, or other dry standing places should be provided where practicable.

40 CFR 112.7(c)(1)(viii)

– General requirements for Spill Prevention, Control, and Countermeasure Plans

Sorbent materials are included in the types of prevention systems that must be used for spill containment.

29 CFR 1910.120(j)(1)(vii)

– Hazardous Waste Operations and Emergency

U.S. Department of Transportation specified salvage drums or containers and suitable quantities of proper absorbents shall be kept available and used in areas where spills, leaks, or ruptures may occur.

OSHA's Recent Silica Ruling

One of the most common compositions for granular absorbents is diatomaceous earth, which is 80-90% silica based. OSHA's recent final rule on limiting exposure to respirable crystalline silica was issued to curb lung cancer, silicosis, chronic obstructive pulmonary disease and kidney disease, all of which have been linked to high levels of silica. Rely on Brady SPC absorbent pads and rolls as safer, more efficient, non-silica solutions for absorbing leaks, drips and spills.

Brady SPC spill control products



best sellers



MRO Plus® and Oil Plus Pads (page 254)

Brady SPC's #1 absorbents are perfect for general everyday use and emergency spill cleanup. Both feature 3-ply meltblown polypropylene construction which increases durability and reduces linting.

Gray MRO Plus is a universal absorbent that handles most fluids (water, petroleum and chemical-based). Oil Plus is an oil-only absorbent for petroleum-based oils, solvents and other non-water-soluble liquids that floats indefinitely even when saturated with oil.



SpillFix® Granular Absorbents (page 274)

When a granular absorbent is necessary, reach for SpillFix granular. A completely natural granular — no carcinogens, no dust, landfill and incinerator safe. SpillFix granular doesn't damage equipment or floors and absorbs four times the liquid of traditional clay granulars.



Spill Berms and Drip Pads (page 278)

These collapsible secondary containment berms and pads can be used to contain spills and leaks from vehicles, machinery, tanks, drums and other industrial equipment.



new



HandySorb™ Mop Systems (page 271)

Easily get to your hard-to-reach spill with the HandySorb Mop System. This innovative absorbent provides “no-touch” pad and pillow options so you can keep your hands out of the mess.



BrightSorb® Safety Absorbents (page 264)

BrightSorb® Safety Absorbents provide an absorbent and brightly colored warning in one convenient product. They are available in a variety of styles including pads, rolls, SOC's, pillows and entire spill kits.



Specialty Spill Kits (page 285)

Specialty spill kits have an assortment of pads, neutralizers, granular, SOC's and the appropriate PPE to help you clean up hazardous spills such as battery acid, bodily fluids, mercury or formaldehyde.

Try absorbents in your facility for free

▶ Request a sample pack at
BradyID.com/SPC



Emergency Egress

BradyID.com/s36

Emergency Egress

When emergency situations occur, it's essential that employees and visitors in the workplace are able to move out of a dark building quickly and safely. BradyGlo™ photoluminescent markings illuminate evacuation routes, guiding people around obstacles, along stairs, through hallways and to the nearest exit.

These quality and reliable glow-in-the-dark products feature:

- High-tack adhesive that's up to 30% stronger than other pressure-sensitive adhesives, so you reduce costs spent on replacements
- Pre-cut sizes and shapes save time and ensure correct and consistent configuration
- Low-profile construction that allows products to easily conform to handrails, stand pipes and other unique shapes for fast application
- Department of Buildings, Materials and Equipment Acceptance (MEA) division approval
- Production in the U.S. for NYC Local Law 26 compliance

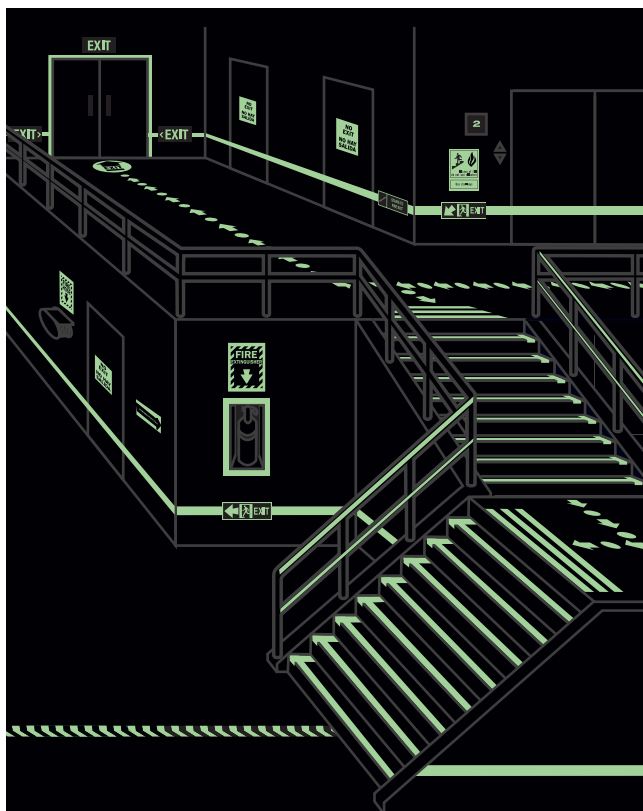

Need-to-know regulations

The following codes and regulations contain provisions for the means of egress and photoluminescent markings on stairs, handrails, signage and more.

Local

New York City Local Law 26

Requires all Class E commercial properties that are 75 feet or taller to use photoluminescent markings on:

- Doors opening to exits and exit passageways
- Landings, perimeters and individual stair steps located within exit passageways
- Obstacles and hazards located within exit passageways
- Directional guidance signs to vertical, horizontal and final exits, plus "Not an Exit" door signs where applicable
- Handrails on building with plans approved after July 1, 2006

National

UL1994 Standard for Luminous Egress Path Marking Systems

Regulates specific materials and testing for photoluminescent egress products for doors, door hardware, door frames, stairs, landings, banisters, obstacles, egress symbols, information placards and more

NFPA CH. 7 Means of Egress

Sets forth requirements for means of egress in both new and existing buildings:

- 7.2.2.5.5.10 Materials. Exit stair path markings shall be made of any material, including paint, provided that an electrical charge is not required to maintain the required luminescence
- 7.2.2.5.5.11 Exit Stair Illumination. Exit enclosures where photoluminescent materials are installed shall be continuously illuminated for at least 60 minutes prior to periods when the building is occupied

International

International Building Code (IBC)

Requires that all non-residential groups A, B, E, I and R-1 for new construction over 75 feet in height must install photoluminescent exit path markings in all enclosed emergency exit stairwells (Code 403.16 and 1024)

International Fire Code (IFC)

Requires that all non-residential buildings groups A, B, E, I, M and R-1 for existing construction over 75 feet in height must install photoluminescent exit path markings in all enclosed emergency exit stairwells (IFC Section 4604)

Brady glow-in-the-dark identification products



BradyGlo™ Exit Signs (page 480)

Non-electric, non-toxic, non-radioactive exit signs are energy efficient and require no power source. Certified by UL for LED lighting as an acceptable charging source. Also compliant to NFPA Life Safety Code 101 and UL 924 Listed.



Perimeter LED Exit Signs (page 477)

Electrical exit signs include a 90-minute nickel cadmium battery back-up assembly for power failure. These signs are listed to UL 924 and in compliance with OSHA, NEC and NFPA standards.



BradyGlo™ Marking Tape (page 303)

Clearly mark emergency evacuation routes and exits with our BradyGlo marking tape, arrows and footprints.

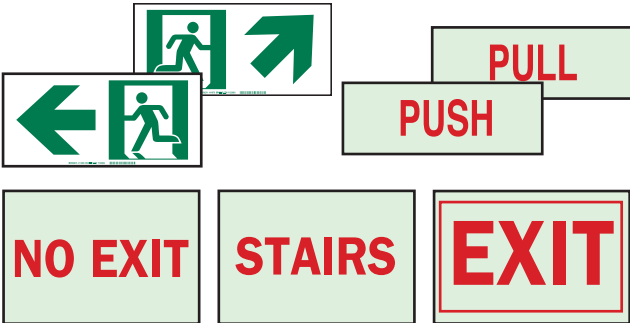

Various Exit and Egress Signs (page 475)

Egress signs available in BradyGlo photoluminescent materials with glow-in-the-dark capabilities.



Print Your Own BradyGlo Signs (page 36)

Create custom evacuation signs and glow-in-the-dark labels with photoluminescent material and your Brady benchtop printer.



Evacuation Maps (page 483)

Clear acrylic frames hold your custom maps and allow you to easily change them when updates are needed.

Information and Communications Technology

As we move to an increasingly wireless world, the amount of cabling in facilities increases as more devices are connected and dated systems are upgraded. In fact, it's estimated that service providers and enterprises spent more than \$1 trillion on telecom / datacom gear and software in the past four years.

Whether you're a designer, installer or end user, you need a trusted partner that understands the specific challenges in the Information and Communications Technology (ICT) industry. Turn to Brady. We bring more than 100 years of experience in identification, providing engineered solutions and industry expertise for a full start-to-finish solution for your ICT needs.

ANSI / TIA-606-C standard

ANSI / TIA-606-C is the latest update to the voluntary standard for administering telecommunications cabling infrastructure, released by the Telecommunications Industry Association (TIA) in July 2017. TIA-606-C builds on the guidelines already established in TIA-606-B, released in 2012, as well as includes some new additions and updates.

Key guidelines include:

- Annex D, which provides additional guidelines for administration of cabling supporting remote powering, including cable bundle identifier scheme. This important development allows automatic infrastructure management systems from different manufacturers to work together.
- Identifier scheme for telecommunications grounding and bonding system elements. These changes specify the use of terms compatible with ISO/IEC 30129. Legacy terms used in versions of the TIA-607 standard earlier than revision C also will be allowed.
- Identifier schemes for telecommunications bonding and grounding system elements, which was changed to align with TIA-607-C.

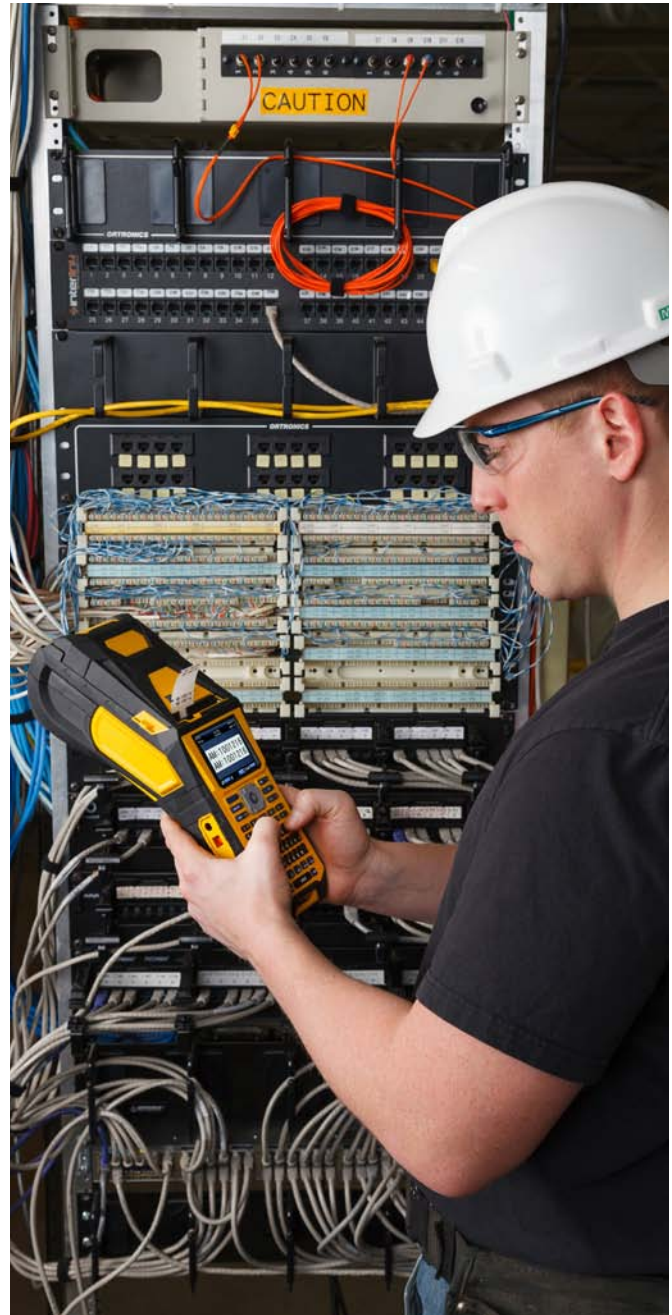

Learn about this new standard and how Brady can help you follow it.

▶ Download at BradyID.com/resources/tia-606-c



Brady ICT labeling solutions



Find the right printer for your application with our comparison guide. (page 102)

1. Label printers (page 102)

Brady portable label printers are essential tools for technicians in the voice and datacomm industry. These printers are easy to use and have a wide range of available label materials and built-in apps for creating wire and cable labels on-site and on-demand.

BradyPrinter M611 Mobile Label Printer (page 126)

Your durable print-from-everywhere solution. Use with the Brady Workstation Express Labels Mobile App or Brady Workstation Desktop Software, and experience the convenience of easy label creation. This combination of printing and mobile technology allows you to get your data whether you're in the office or in the field, and print via Bluetooth or Wi-Fi. Integrates with Fluke Networks® LinkWare™ Live. Requires free Express Labels Mobile App or Brady Workstation Desktop Software.



Sleeves

Wrap-around

Self-laminating

2. Label materials (page 130)

Brady label materials are made to withstand industrial environments and are available in a variety of sizes, colors and material types.

In addition to standard safety and component labels, you can make specialty labels for voice and datacom applications, including wire wraps, self-laminating vinyl labels, heat shrink wire marking sleeves, cable tags, panel component labels, terminal block labels and more.



Flags / tags

Equipment labels

Patch panels

3. Software

Brady Workstation Wire ID Suite (page 178)

For creating wire and cable labels, the Brady Workstation Wire Identification Suite includes the right mix of Workstation apps. It allows you to easily create single-line labels and labels with wrapping text, and to serialize and import data without having to worry about alignment. If you are labeling or wrapping wires and cables, this is the suite for you.

NetDoc® Cable Management Software (page 179)

NetDoc Cable Management Software allows you to easily document your cable infrastructure so you know what cables you have, where they are and what they are connected to. The user-friendly input feature and the import tool speed data transfer to drastically reduce data entry time.





Bring Confidence to Your Safety Program

Your comprehensive safety program is an essential area of your business, helping to provide a safe and productive work environment for your employees, while also avoiding the costly impact of a violation or incident. Take a proactive approach and implement compliant, sustainable solutions to create a safety program that you and your employees can depend on.

Your safety solutions partner

Starting and maintaining a safety program can be daunting, but with the right partner, the process can be efficient, effective and completed with confidence. We provide a start-to-finish solution, which means we can jump in and help at any stage of your lockout tagout, arc flash and confined space program development. Rely on our in-house team of industry experts to work with you to create a world-class safety program that is sustainable and compliant, supported by:

- **Our insights:** Field engineers from different backgrounds to provide a variety of perspectives and find potential safety gaps others won't
- **Our services:** Industry-trusted expertise in lockout tagout, arc flash and confined space to keep you and your team protected
- **Our products:** Safety products and software designed by experts and engineered to perform

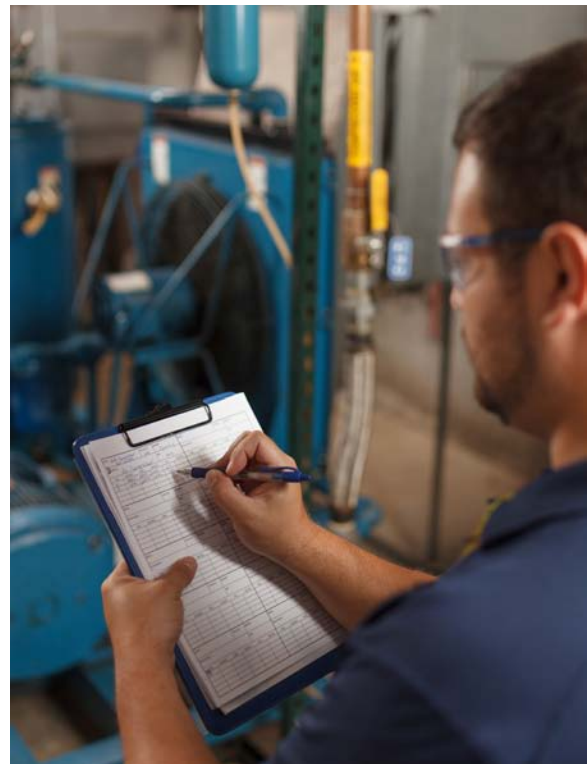

Don't miss our extensive collection of resources online:

- Leading Indicators for a Sustainable Lockout Program
- Lockout Tagout Program Checklist
- 7 Things to Avoid When Creating Lockout Procedures
- 5 Reasons to Choose an Engineered Analysis Over the Categories Method to Perform your Arc Flash Assessment
- Arc Flash Safety Check Up
- Examples of our Assessment and Audit Deliverables



Visit BradyID.com/Services



Lockout Tagout Services

With a continually changing workforce, and frequent enhancements to processes and technology, there is a need in the industry to efficiently develop and train new workers to keep operations running smoothly. Having a sustainable lockout tagout program in place allows you to bridge the knowledge gap and improve safety throughout your facility.

Rely on our team of experts to deliver:

- **Machine inventories** with a full list of equipment that requires a procedure and number of isolation points
- **Complete visual lockout tagout procedures**, including authoring and installing procedures, and tagging all energy isolation points
- **Procedure audits** to comply with OSHA's periodic inspection requirement
- **Training** that includes options for general/affected, authorized employee and train the trainer
- **Program development** support to assess your current state and provide a program implementation guide
- Additional lockout services, including alternative method procedures/minor servicing, job safety analysis, gap analysis, and time- and material-based services



BRADY Lockout/Tagout Posted Procedure

BRADY Good Hope - Boiler Room
Production
Boiler #1

4 Lockout Points

Note: This machine is capable of generating extremely high temperatures. Allow it to return to room temperature before proceeding. Confined Space. Authorized personnel only. Permits are required before entering. Follow all Confined Space procedures. Flaring systems can store energy hydraulically. Ensure pressures are isolated and/or have been relieved before proceeding.

MCC 3 Column 3 Bucket A EAST VIEW NORTH VIEW

Step #	Action	Info	Verification
1 Disconnect	The E-1 Disconnect is located on the East side of the machine on the MCC panel Columns 3 bucket A. Turn Disconnect to the off position and lock out.	Use a Lock and hasp device.	Attempt to restart at control panel.
2 G-1 Ball Valve	The G-1 Ball Valve is located on the East side of the machine. Turn Valve to the off position and lock out.	Use a Ball valve lockout device.	Verify pressure has bled off.
3 W-1 Buttery Valve	The W-1 Buttery Valve Lockout is located on the East side of the machine. Turn the valve to the closed position and lock out.	Use a Lock and hasp device.	Verify pressure has bled off.
4 W-2 Buttery Valve	The W-2 Buttery Valve Lockout is located on the East side of the machine. Turn the valve to the closed position and lock out.	Use a Lock and hasp device.	



Brady products complete your lockout tagout program.

LINK360® software

Brady offers software and products to create and maintain an effective safety program. With LINK360 software, you can easily create and maintain visual lockout procedures, as well as reports and audits.

Brady Safety Software and Services

BradyID.com/s36

Brady Safety Software and Services

Arc Flash Services

Creating a world-class arc flash program in-house requires time, engineered resources and power system analysis software to accurately calculate arc flash risk beyond general scenarios. Our electrical engineers work with you to create an arc flash solution that meets your needs, and keeps you compliant.

Brady Safety Services can help:

- **Review your current program** and any past assessments, and then identify any safety issues or needed compliance improvements
- **Perform risk assessments** to compile data for arc flash calculations, create a single-line diagram and report, and then install the needed labels
- **Offer training options** including refresher, qualified persons and train-the-trainer sessions



new

Infrared Thermography Service

Brady can conduct infrared inspections, or include them with an Arc Flash Risk Assessment. Our certified infrared thermographers use a specialized infrared camera to detect any hot spots that may need attention in your equipment. They provide:

- A comprehensive report, either Standard (only hot spots provided) or Expanded (all pictures included in report)
- Recommendations for improvements and/or repairs for each identified hot spot
- Imaging of your electrical distribution system components

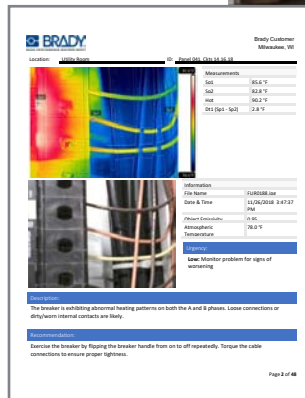

Brady products complete your arc flash program.

Pre-printed arc flash labels

Order pre-printed arc flash labels for your equipment.

Label printers

Customize and create arc flash labels on demand with a Brady sign and label printer, such as the BradyPrinter S3100.

Brady Workstation label creation software

With the Arc Flash Labels app, creating the right arc flash labels for your workplace is quick and simple.

Confined Space Services

To align with OSHA requirements, employers must evaluate and identify permit-required confined spaces, as well as develop procedures for entry and training. Common confined spaces include elevators and storage tanks. Find out how Brady can support your confined space program.

Our experts will come on-site to:

- **Take inventory**, collect data and classify each space as permit or non-permit required
- **Perform hazard assessments** to evaluate specific hazards, methods of protection and verification, label needs, worker classification, PPE requirements and more
- **Conduct training** focused on best practices, client-specific program elements, an overview of the 1910.146 OSHA regulation and more

What's our process?

A Brady safety professional will come on-site and collaborate with your subject matter expert to identify spaces and their hazards. We then continue to build your inventory, including classifying your confined spaces as permit or non-permit required. All permit-required confined spaces will be further defined by their hazards, such as engulfment or atmospheric hazards, in a permit-required confined space hazard analysis.



Brady Part		Equipment ID#	Task ID#	BRADY
CONFINED SPACE PROFILE ASSESSMENT		Classid:	201102013	
PERMIT REQUIRED		Revised:	5/5/2015	
Confined Space Description: <i>Three Tanks Entry For Service Tank</i> Description (Job/Equipment): <i>Three Tanks Entry For Service Tank</i> Operational/Control Procedures: <i>Lockout, Tag, & Bypass Switch</i>		Equipment Required: Hard Hat Eye/Face Protection Boots Gloves Fall Protection Clear (Calibrated) Gas Meter (REQUIRED FOR ALL ENTRIES) LOTO		
		Hazards: <i>Engulfment, Atmospheric, Confined Space</i> Verification: <i>Atmospheric, Confined Space</i> Permit: <i>Permit Required</i> Entry: <i>Permit Required</i> Exit: <i>Permit Required</i> Rescue: <i>Permit Required</i> Other: <i>Permit Required</i>		
HAZARDS ASSOCIATED WITH CONFINED SPACE				
Hazard	Control & Control Method (Mitigation)	Verification		
1. Atmospheric	Atmospheric conditions for 1910.146 (b) (5) (D) must be tested prior to entry and continuously monitored.	Atmospheric conditions for 1910.146 (b) (5) (D) must be tested prior to entry and continuously monitored.		
2. Engulfment	Engulfment hazards are identified and controlled prior to entry.	Engulfment hazards are identified and controlled prior to entry.		
3. Confined Space	Confined space is properly identified & permit required.	Confined space is properly identified & permit required.		

Brady Safety Software and Services

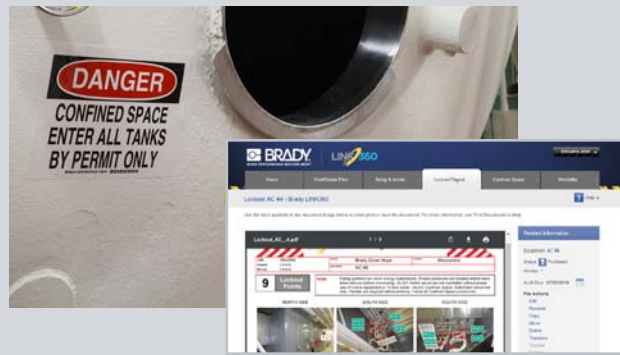

Brady products complete your confined space program.

Confined space signage
Order pre-printed signage, or create your own with an on-demand sign printer, such as the BBP[®]37 printer.

LINK360[®] software
Easily create and maintain confined space procedures, as well as reports and audits.

Benchtop Printer Comparison

BradyID.com/s36

Benchtop Printer Comparison Guide

Use the following comparison guide to quickly see which benchtop printer best fits your application needs. Then turn to the following pages to find out more about the printer, compatible materials and ribbons.

Benchtop Printers



BradyPrinter S3000 Label Printer
See page 28



BradyPrinter S3100 Sign and Label Printer
See page 30



BradyPrinter i3300 Label Printer
See page 32



BBP®35 Multi-color Label Printer
See page 34

Description			
4 in. PC-connect printer for SFID. Does not offer user standalone use and accessibility or networking capability, but does have smaller footprint than BradyPrinter S3100.	4 in. standalone and PC-connect printer for SFID with Wi-Fi connectivity. Standalone use is ideal for multi-user situations and lean 5S kaizen labeling events. The ultimate in easy and accessible.	4 in. PC-connect-only printer for SFID, die-cut wire ID and product ID labels. Printer is networkable. Does not offer user standalone use but does have extra label types.	4 in. standalone and PC-connect printer for SFID with multi-color printing and fast print speed. Standalone use is ideal for multi-user situations and lean 5S kaizen labeling events. The ultimate in easy and accessible with multiple colors.

Printer Overview			
0.5 to 4 in. wide output 4 in./sec. print speed	0.5 to 4 in. wide output 3 in./sec. print speed	0.25 to 4.25 in. wide output up to 4 in./sec. print speed	0.5 – 4 in. wide output 5 in./sec. print speed
PC-connect only	Standalone and PC-connect printing	PC-connect only	Standalone and PC-connect printing
Monocolor printing (1 print color on a label)	Monocolor printing (1 print color on a label)	Monocolor printing (1 print color on a label)	Monocolor and multi-color printing
20-second material changeovers Set-up: no calibration, no sensor adjust, no label waste (prints on first label)	20-second material changeovers Set-up: no calibration, no sensor adjust, no label waste Easy user interface – just walk up and print	20-second material changeovers Set-up: no calibration, no sensor adjust, no label waste (prints on first label)	20-second material changeovers Set-up: no calibration, no sensor adjust, no label waste Easy user interface – just walk up and print
300+ parts, 14 materials (for SFID), 14 parts, 14 materials (for product ID)	300+ parts, 14 materials (for SFID) 14 parts, 14 materials (for product ID)	300+ parts, 14 materials (for SFID) 485 parts, 45 materials (for wire ID and product ID)	300+ parts, 14 materials (for SFID) 14 parts, 14 materials (for product ID)
Software: Brady Workstation	Software: Brady Workstation	Software: Brady Workstation	Software: Brady Workstation
5-year warranty	5-year warranty	5-year warranty	5-year warranty

Compatible Supplies			
B30-series materials (all)	B30-series materials (all)	B33- and B30-series materials	B30-series materials (all)
B30-series ribbons (excluding multi-color panel ribbons)	B30-series ribbons (excluding multi-color panel ribbons)	B30-series ribbons (excluding multi-color panel ribbons)	B30-series ribbons (all)

Applications			
Arc flash labels Cold-temperature labels Equipment marking Facility ID GHS and chemical labels Glow-in-the-dark labels Lean / 5S Magnetic labels Panel labels Pipe and valve marking Push button labels Reflective labels	Arc flash labels Equipment labels GHS labels Pipe markers Safety signs Warning labels Lean / 5S labels Panel and enclosure ID Tags Barcode labels	Arc flash labels Equipment labels GHS labels Pipe markers Safety signs Warning labels Lean / 5S labels Panel and enclosure ID Inside panel and automation ID Wire and cable ID Tags Barcode labels Miscellaneous die-cut labels Circuit board labels Product labels (OEM) Laboratory specimen labels	Arc flash labels (w/ red variables) Equipment labels GHS labels Pipe markers Safety signs (multi-color) Warning labels (multi-color) Lean / 5S labels Panel and enclosure ID Tags Multi-color labels

Benchtop Printer Comparison

BradyID.com/s36



BBP®37 Multi-color and Cut Label Printer
See page 34



BBP®85 Label Printer
See page 76



BradyJet J2000 Color Label Printer
See page 84



BradyJet J5000 Color Label Printer
See page 86

Positioning

4 in. standalone and PC-connect printer for SFID with multi-color printing, shape-cutting capabilities (BBP37 only) and fast print speed. Standalone use is ideal for multi-user situations and lean 5S kaizen labeling events. The ultimate in easy and accessible with multiple colors, and letter- and shape-cutting options.

10 in. standalone and PC-connect printer for SFID with multi-color printing. Particularly popular for any large labeling needs. Ideal for large signs, large GHS labels and large equipment placards. The ultimate in easy and accessible with multiple colors for larger output.

Full-color, high-resolution ink jet printer for creating photo-quality labels in a single pass, while reducing material waste and needed inventory of labeling supplies. Significantly smaller footprint than BradyJet J5000.

8 in. PC-connect printer with high-resolution, high-speed color label printing. Ideal for creating full-color labels with images, logos, illustrations, barcodes and more. The ultimate in high-resolution printing in all colors.

Printer Overview

0.5 to 4 in. wide output 5 in./sec. print speed	4 to 10 in. wide output 1 in./sec. print speed	0.75 to 4 in. wide output Up to 2.5 in./sec. print speed	2 to 8 in. wide output Up to 6 in./sec. print speed
Standalone and PC-connect printing	Standalone and PC-connect printing	PC-connect only	PC-connect only
Monocolor and multi-color printing X-Y plotter cutter to cut out text and shapes	Monocolor and multi-color printing	Full-color printing	Full-color printing
20-second material changeovers Set-up: no calibration, no sensor adjust, no label waste Easy user interface – just walk up and print	40-second material changeovers Set-up: no calibration, no sensor adjust, no label waste Easy user interface – just walk up and print	20-second material changeovers and 10-second ink cartridge changeovers Set-up: self-fed materials	20-second material changeovers and 10-second ink cartridge changeovers Set-up: self-fed materials, no sensor adjustment
300+ parts, 14 materials (for SFID) 14 parts, 14 materials (for product ID cut-outs)	125 parts, 5 materials (for SFID)	15 parts, 3 materials (for SFID) 15 parts, 1 material (for lab ID)	18 parts, 2 materials
Software: Brady Workstation	Software: Brady Workstation	Software: Brady Workstation	Software: Brady Workstation
5-year warranty	5-year warranty	1-year warranty	1-year warranty

Compatible Supplies

B30-series materials (all)	B85-series and PowerMark materials	J20-series materials (all)	J50-series materials (all)
B30-series ribbons (all)	B85-series and PowerMark ribbons	J20-CMY ink cartridge	J50-series ink cartridges (all)

Applications

Arc flash labels (w/ red variables) Equipment labels GHS labels Pipe markers (single or multiple-up) Safety signs (multi-color) Warning labels (multi-color) Lean / 5S labels Panel and enclosure ID Tags Multi-color labels Cut-out text and shapes Circular or custom shaped labels Miscellaneous die-cut labels (cut out) Multiple-up cut-out labels Gauge labels Gradient ruler labels Product labels (cut out small batch)	Larger output Equipment labels (larger) GHS labels (larger) Safety signs (larger) Multi-color labels (larger)	GHS labels Pipe markers Warehouse marking Visual workplace labeling Lean / 5S labels Lockout Tags General ID Industrial ID Laboratory ID	Arc flash labels (w/ red variables) Equipment labels GHS labels Pipe markers Safety signs and warning labels (multi-color) Lean / 5S labels Multi-color labels Lock labels (w/ photos) Asset management Department signage Finished goods
---	---	--	---

BradyPrinter S3000 Sign and Label Printer

BradyID.com/s36

Benchtop Printers



BradyPrinter S3000 SIGN & LABEL PRINTER

High-Performance, Entry-Level Industrial Printing

Turn busy work into smarter work. Get state-of-the-art printing capabilities in a compact package with the BradyPrinter S3000 Sign and Label Printer.

- Get lightning-fast setup times with print smart technology that auto-calibrates print settings when you load materials so you can print on the first label
- Easily make any adjustments you need to on the large color touchscreen
- Changing materials is made easy with drop-in fool-proof loading so changeovers take as few as 20 seconds
- Versatility with more than 330 parts and 26 materials options, including ToughStripe® Floor Marking Tape
- Move through your print jobs fast with print queue capabilities that automatically prints the next batch after the first one is finished
- Create labels with ease when you add Brady Workstation Label Creation Software apps and suites

▶ Learn more at
BradyID.com/s3000

Printer at-a-glance

- Small footprint
- PC-connect printer
- Single color printing
- Safety and facility ID labels only
- 330 parts, 26 materials

Printing supplies

B30-series label rolls page 36
B30-series print ribbons page 74

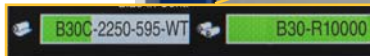
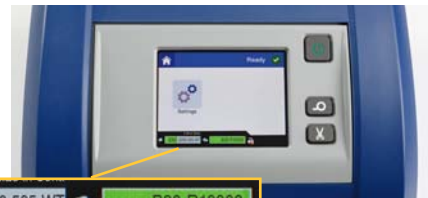

Supply status is conveniently displayed on screen

Catalog #	Description
S3000	BradyPrinter S3000 Sign and Label Printer
B31-WIPER	Extra media wipers (5 per pack)
PCK-6	Cleaning swabs that are pre-soaked in IPA (50 per pack)

* Printer includes power cord, Quick Start Guide, USB cable, cleaning kit and cutter cleaning tool.

High-performance safety and facility labels



Pipe marking



GHS labeling



Safety tags



Lean / 5S labeling



Safety signs



Equipment and panel labeling

S3000

BradyPrinter S3000 Sign and Label Printer

BradyID.com/s36

Printer specifications

Overview	4 in. PC-connect printer for SFID. Does not offer user standalone use and accessibility or networking capability, but does have smaller footprint than BradyPrinter S3100.
Applications	Arc flash labels, cold-temperature labels, equipment marking, facility ID, GHS and chemical labels, glow in the dark labels, lean / 5S, magnetic labels, panel labels, pipe and valve marking, push button labels, reflective labels
Label materials	Extremely aggressive 8-10 year outdoor vinyl with high tack and chemical resistance, plus wash-down material, 10-hr glow in the dark, reflective, magnetic, tags, engraved plate substitute and more.
Label formats	Continuous tapes, pre-printed and blank die-cut labels
Print technology	Thermal transfer
Print resolution	300 dpi
Print speed	4 in./sec.
Media widths	0.5 to 4 in.
Min. label dimension	0.5 in.
Color printing capabilities	Monocolor printing (some pre-printed multi-color supplies also available)
Auto cut-off	Yes
X-Y plotter cutting (cut-out shapes / text)	No
PC-connect or standalone operation	PC-connect only
Connectivity options	USB
Compatible software	Brady Workstation Apps
Compatible materials	B30 series (all)
Compatible ribbons	B30 series (excluding multi-color panel ribbons)
Calibration required	No (no waste)
Label creation and set-up	Automatic (printer or PC software reads data on chip and automatically sets up label size, color, fonts, etc.)
Ribbon and label roll installation	Labels: Supplied in cartridge, drops into place, 15-second changeover Ribbon: Supplied in cartridge, snaps into place, 5-second changeover
Warranty	5 years

US. Patent No. #6364552, #5823689, #6570602, #8539868



Brady Workstation Safety and Facility ID Suite

Brady Workstation has revolutionized how you design and print labels from your PC. When paired with the high-performance printing capabilities of a Brady printer, you get intuitive label set up for simple, efficient and flexible label creation.

This suite features:

- A collection of applications for creating the custom signs, labels and pipe markers you need to add visual safety guidance to your facility
- The ability to serialize and import your data onto the labels
- Real-time information about the label material installed, enabling easy label set up
- Built-in regulations, standards, pictograms, common phrases, data importation guidance, help functions and more

▶ Learn more on page 176 or download a free trial at Workstation.BradyID.com

Brady360® 5-year Warranty

We stand behind our products and have strengthened our commitment to you with a **5-year printer warranty standard and free of charge** on our benchtop printer models.* With our team of certified tech support and repair technicians, you can rest easy knowing you have the support you need, every step of the way.



*Excludes repairs due to negligence. Excludes Wraptor™, BradyJet and portable models. For full coverage details and restrictions, visit BradyID.com/brady360

Benchtop Printers

S3000

BradyPrinter S3100 Sign and Label Printer

BradyID.com/s36

Benchmark Printers

S3100



BradyPrinter S3100 SIGN & LABEL PRINTER

Walk-up-and-print for ultimate ease of use

Just walk up and print. Literally. The best choice for facility, safety and Lean / 5S labeling

- Intuitive, simple to learn, very approachable. Ideal for multi-user situations, events and centrally located print stations — simple training
- 20-second supply changeover with no waste, calibration or trial and error setup
- Standalone use or PC-Connect use all in one printer
- Automatic label setup with no calibration — the printer “reads” information from your cartridges and automatically sets up the label correctly in the printer or your Brady software

▶ Learn more at BradyID.com/s3100



Easy to load
drop-in
supplies

Printer at-a-glance

- Small footprint
- PC-connect or standalone printing
- Touchscreen label creation
- Single color printing
- Safety and facility ID labels only
- 385 parts, 14 materials

Printing supplies

B30-series label rolls page 36
B30-series print ribbons page 74

Catalog #	Description
S3100W-BWSSFID	BradyPrinter S3100 Printer with Brady Workstation Safety and Facility ID Software Suite*
S3100-W	BradyPrinter S3100 Printer*
120994	Padded rolling case with handle and supplies pockets
B31-WIPER	Extra media wipers (5 per pack)
B31-CCT	Cutting Tool
PCK-6	Cleaning swabs that are pre-soaked in IPA (50 per pack)
Printer and Supplies Starter Kits. Kit contents on page 72.	
S3100W-ARC-KIT	BradyPrinter S3100 Printer w/ Arc Flash Supply Kit*
S3100W-GHS-KIT	BradyPrinter S3100 Printer w/ GHS Supply Kit*
S3100W-SAFE-KIT	BradyPrinter S3100 Printer w/ Safety Supply Kit*
S3100W-LEAN-KIT	BradyPrinter S3100 Printer w/ 5S Visual Workplace Supply Kit*
S3100W-PIPE-KIT	BradyPrinter S3100 Printer w/ Pipe ID Supply Kit*
S3100W-GEN-KIT	BradyPrinter S3100 Printer w/ General Industrial Supply Kit*

* Printer ships with power cord, USB cable, network card, drivers CD, stylus, cleaning kit, cutter cleaning tool, Quick Start Guide and documentation holder.

Just walk up and print. So simple, your whole team can use it



Pipe marking



GHS labeling



Safety tags



Lean / 5S labeling



Safety signs



Equipment and panel labeling

BradyPrinter S3100 Sign and Label Printer

BradyID.com/s36

Printer specifications

Overview	4 in. standalone and PC-connect printer for SFID with Wi-Fi connectivity. Standalone use is ideal for multi-user situations and lean 5S kaizen labeling events. The ultimate in easy and accessible.
Applications	Arc flash labels, equipment labels GHS labels, pipe markers, safety signs, warning labels, lean / 5S labels, panel and enclosure ID, tags barcode labels
Label materials	Extremely aggressive 8-10 year outdoor vinyl with high tack and chemical resistance, plus wash-down material, 10-hr glow in the dark, reflective, magnetic, tags, engraved plate substitute and more.
Label formats	Continuous tapes, pre-printed and blank die-cut labels
Print technology	Thermal transfer
Print resolution	300 dpi
Print speed	3 in./sec.
Media widths	0.5 to 4 in.
Min. label dimension	0.5 in.
Color printing capabilities	Monocolor printing (some pre-printed multi-color supplies also available)
Auto cut-off	Yes
X-Y plotter cutting (cutout shapes / text)	No
PC-connect or standalone operation	Standalone and PC-connect printing
Connectivity options	Standard: USB, Ethernet Optional: Wi-Fi, Wi-Fi Direct
Compatible software	Brady Workstation Apps
Compatible materials	B30 series (all)
Compatible ribbons	B30 series (excluding multi-color panel ribbons)
Calibration required	No (no waste)
Label creation and set-up	Automatic (printer or PC software reads data on chip and automatically sets up label size, color, fonts, etc.)
Ribbon and label roll installation	Labels: Supplied in cartridge, drops into place, 15-second changeover Ribbon: Supplied in cartridge, snaps into place, 5-second changeover
Warranty	5 years

U.S. Patent No. 8,542,155; 8,648,891; 5,823,689; 6,570,602. Additional patents pending.



Brady Workstation Safety and Facility ID Suite

Brady Workstation has revolutionized how you design and print labels from your PC. When paired with the high-performance printing capabilities of a Brady printer, you get intuitive label set up for simple, efficient and flexible label creation.

This suite features:

- A collection of applications for creating the custom signs, labels and pipe markers you need to add visual safety guidance to your facility
- The ability to serialize and import your data onto the labels
- Real-time information about the label material installed, enabling easy label set up
- Built-in regulations, standards, pictograms, common phrases, data importation guidance, help functions and more

▶ **Learn more on page 176 or download a free trial at Workstation.BradylD.com**

Brady360® 5-year Warranty

We stand behind our products and have strengthened our commitment to you with a **5-year printer warranty standard and free of charge** on our benchtop printer models.* With our team of certified tech support and repair technicians, you can rest easy knowing you have the support you need, every step of the way.



*Excludes repairs due to negligence. Excludes Wraptor™, BradyJet and portable models. For full coverage details and restrictions, visit BradyID.com/brady360

Benchtop Printers

S3100

BradyPrinter i3300 Industrial Label Printer

BradyID.com/s36

Benchmark Printers



BradyPrinter i3300 INDUSTRIAL LABEL PRINTER

No waste. More labels. Less effort.

Picture your ideal label printing scenario – the labels and ribbons snap into place, there's no calibration process, you don't have to throw away blank labels before you actually print one. Ideal is now real with the BradyPrinter i3300 Industrial Label Printer. This mid-volume industrial label printer makes your identification projects easy, fast and affordable. Enjoy a variety of time- and money-saving advantages, including:

- **No waste printing:** With print smart technology, you get auto setup and calibration without throwing out blank labels
- **Fast material changeovers:** Foolproof drop-in label rolls and ribbons snap into place for 20-second material changeovers
- **Full-facility identification:** Complete all of your identification tasks, from wires, panels and products to safety and facility labels, with one convenient and efficient tool

▶ Learn more at BradyID.com/i3300



Print on the first label or sleeve — even on the smallest labels

Printer at-a-glance

- Small footprint
- PC-connect printing
- Single color printing
- Safety, facility, wire and product ID labels
- 300+ parts, 14 materials (for SFID)
350+ parts, 28 materials (Product and Wire ID)

Printing supplies

B30- and B33-series label rolls page 36
B30-series print ribbons page 74

Catalog #	Description
149552	BradyPrinter i3300 w/ Brady Workstation Basic Suite
150643	BradyPrinter i3300 w/ Brady Workstation Safety and Facility ID Suite
150645	BradyPrinter i3300 w/ Brady Workstation GHS App
150640	BradyPrinter i3300 w/ Brady Workstation Product and Wire ID Suite
150642	BradyPrinter i3300 w/ Brady Workstation Laboratory ID Suite
150639	BradyPrinter i3300 w/ Brady Workstation Scan and Print and Scanner
120994	Padded rolling case with handle and supplies pockets
B31-WIPER	Extra media wipers (5 per pack)
B31-CCT	Cutting Tool
PCK-6	Cleaning swabs that are pre-soaked in IPA (50 per pack)

* Printer ships with cleaning kit, cutter cleaning tool, power cord, product CD, Quick Start Guide and USB cable.

Product and wire ID in addition to safety and facility ID



Industrial labeling



Arc flash labeling



Circuit board labeling



Product ID labels



Wire and cable labels



Raised panel labels and more

i3300

BradyPrinter i3300 Industrial Label Printer

BradyID.com/s36

Printer specifications

Overview	4 in. PC-connect-only printer for SFID, die-cut wire ID and product ID labels. Printer is networkable. Does not offer user standalone use but does have extra label types.
Applications	Arc flash labels, equipment labels, GHS labels, pipe markers, safety signs, warning labels, lean / 5S labels, panel and enclosure ID, inside panel and automation ID, wire and cable ID, tags, barcode labels, miscellaneous die-cut labels, circuit board labels, product labels (OEM), laboratory specimen labels
Label materials	Extremely aggressive 8-10 year outdoor vinyl with high tack and chemical resistance, plus, wash down material, reflective, 10-hour glow-in-the-dark, engraved plate substitute, 33 other materials
Label formats	Continuous material, pre-printed and blank die-cut labels, wire labels and sleeves
Print technology	Thermal transfer
Print resolution	300 dpi
Print speed	up to 4 in./sec.
Media widths	0.5 to 4.25 in.
Min. label dimension	0.25 in.**
Color printing capabilities	Monocolor printing (some pre-printed multi-color supplies also available)
Auto cut-off	Yes
X-Y plotter cutting (cutout shapes / text)	No
PC-connect or standalone operation	PC-connect only
Connectivity options	Standard: USB, Ethernet Optional: Wi-Fi, Wi-Fi Direct
Compatible software	Brady Workstation Apps
Compatible materials	B33 series (all) B30 series (all)
Compatible ribbons	B30 series (excluding multi-color panel ribbons)
Calibration required	No (no waste)
Label creation and set-up	Automatic (printer or PC software reads data on chip and automatically sets up label size, color, fonts, etc.)
Ribbon and label roll installation	Labels: Supplied in cartridge, drops into place, 15-second changeover Ribbon: Supplied in cartridge, snaps into place, 5-second changeover
Warranty	5 years

** Performance at minimum label dimension is dependent on label text and size of print run; Users should test suitability for their application.

U.S. Patent No. 5,823,689; 6,570,602.
Additional patents pending.



Brady Workstation Product and Wire ID Suite

Brady Workstation has revolutionized how you design and print labels from your PC. When paired with the high-performance printing capabilities of a Brady printer, you get intuitive label set up for simple, efficient and flexible label creation.

This suite features:

- A collection of applications for creating product labels, wire and cable markers, panel labels and more
- The ability to serialize and import your data onto the labels
- Specialty label design apps for asset tags, terminal block and patch panel labels
- Real-time information about the label material installed, enabling easy label set up
- Apps feature built-in regulations, standards, pictograms, common phrases, data importation guidance, help functions and more

▶ Learn more on page 176 or download a free trial at Workstation.BradyID.com

Brady360® 5-year Warranty

We stand behind our products and have strengthened our commitment to you with a **5-year printer warranty standard and free of charge** on our benchtop printer models.* With our team of certified tech support and repair technicians, you can rest easy knowing you have the support you need, every step of the way.



*Excludes repairs due to negligence. Excludes Wraptor™, BradyJet and portable models. For full coverage details and restrictions, visit BradyID.com/brady360

BBP[®]35 and BBP[®]37 Label Printers

BradyID.com/s36

Benchtop Printers



Learn more at BradyID.com/bbp37

BBP[®]35
MULTICOLOR LABEL PRINTER

BBP[®]37
MULTICOLOR & CUT LABEL PRINTER

Color your way to an improved workplace

The BBP35 and BBP37 label printers give you the power to make signs and labels in the colors and shapes you need to make an impact – right when you need them.

- **Multiple print colors** – Color is more memorable, more effective and is the differentiator you need to effectively improve workplace safety and productivity
- **Shape cutting with the built-in XY plotter cutter (BBP37 only)** – Cut out shapes and text, or cut around your message to create labels that look and fit how you want them to
- **Label making made easy** – Incredibly easy and intuitive interface makes it ideal for multiple users, centralized locations and lean / 5S events
- **Automatic label setup** – Printer reads critical information from the supplies and then automatically sets up the label attributes in the printer so you can start printing immediately
- **Time saving** – 20-second changeovers with drop in ribbon and label supplies

Printer at-a-glance

- Single and multi-color printing
- Cuts out shapes and text (BBP37 only)
- PC-connect or standalone printing
- Touchscreen label creation
- 300+ parts, 14 materials (for SFID)
14 parts, 14 materials (for product ID)

Printing supplies

B30-series label rolls page 36
B30-series print ribbons page 74



Multi-color printing in a single print pass



Cut-out shapes and text with the BBP37 printer
(Requires 4 in. wide material. Cut-out text must be 0.75 in. or larger.)

Catalog #	Description
BBP35	BBP35 Multicolor Label Printer*
BBP37	BBP37 Multicolor and Cut Label Printer*
120994	Rolling case with handle, 2 pockets for supplies
BBP35-37-WIPER	BBP35/37 Media Wiper (1 each)
B31-CCT	Cutting Tool
PCK-6	Cleaning swabs that are pre-soaked in IPA (50 per pack)
B37-BLADE	Replacement XY cutting blade for BBP37 (1 each)
76737	Transfer tape for cut-out objects (300 ft. roll)

* Printer ships with cleaning kit, cutter cleaning tool, power cord, Quick Start Guide and USB cable.

Unprecedented capabilities set the standard in safety and facility ID



Safety and industrial signage



GHS hazcomm labels



Safety and compliance labels



Product ID labels



Pipe markers

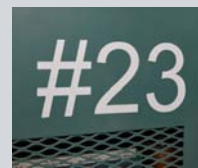

Cut-out shapes and text with BBP37 printer

BBP35 / BBP37

BBP[®]35 and BBP[®]37 Label Printers

BradyID.com/s36

Printer specifications

Overview	4 in. standalone and PC-connect printer for SFID with multi-color printing and fast print speed. Standalone use is ideal for multi-user situations and lean 5S kaizen labeling events. The ultimate in easy and accessible with multiple colors.
Applications	Arc flash labels (w/ red variables), equipment labels, GHS labels, pipe markers, safety signs (multi-color), warning labels (multi-color), lean / 5S labels, panel and enclosure ID, tags, multi-color labels
Label materials	Extremely aggressive 8-10 year outdoor vinyl with high tack and chemical resistance, plus Toughstripe [®] floor tape, wash-down material, 10-hr glow in the dark, reflective, magnetic, tags, engraved plate substitute and 20 other materials.
Label formats	Continuous tapes, pre-printed and blank die-cut labels
Print technology	Thermal transfer
Print resolution	300 dpi
Print speed	5 in./sec.
Media widths	0.5 to 4 in.
Min. label dimension	0.5 in.
Color printing capabilities	Monocolor and multi-color printing
Auto cut-off	Yes
X-Y plotter cutting (cutout shapes / text)	Yes, BBP37 model only
PC-connect or standalone operation	Standalone and PC-connect printing
Connectivity options	Standalone use, Ethernet, USB
Compatible software	Brady Workstation Apps
Compatible materials	B30 series (all)
Compatible ribbons	B30 series (all)
Calibration required	No (no waste)
Label creation and set-up	Automatic (printer or PC software reads data on chip and automatically sets up label size, color, fonts, etc.)
Ribbon and label roll installation	Labels: Supplied in cartridge, drops into place, 15-second changeover Ribbon: Supplied in cartridge, snaps into place, 5-second changeover
Warranty	5 years

U.S. Patent No. 6364552 B1; 6788324; 6768502 B2; BBP37 printer: 6664995 B2; Ribbon cartridges: 6860658 B2; D480749



Brady Workstation Safety and Facility ID Suite

Brady Workstation has revolutionized how you design and print labels from your PC. When paired with the high-performance printing capabilities of a Brady printer, get intuitive label set up for simple, efficient and flexible label creation.

This suite features:

- A collection of applications for creating the custom signs, labels and pipe markers you need to add visual safety guidance to your facility
- The ability to serialize and import your data onto the labels
- Real-time information about the label material installed, enabling easy label set up
- Built-in regulations, standards, pictograms, common phrases, data importation guidance, help functions and more

▶ **Learn more on page 176 or download a free trial at Workstation.BradyID.com**

Brady360[®] 5-year Warranty

We stand behind our products and have strengthened our commitment to you with a **5-year printer warranty standard and free of charge** on our benchtop printer models.* With our team of certified tech support and repair technicians, you can rest easy knowing you have the support you need, every step of the way.



*Excludes repairs due to negligence. Excludes Wraptor[™], BradyJet and portable models. For full coverage details and restrictions, visit BradyID.com/brady360

Benchtop Printers

BBP35 / BBP37

B30- and B33-Series Materials

BradyID.com/s36

B30- and B33-Series Material Supplies

Specifically designed for use with the BradyPrinter S3000, S3100, i3300, BBP®30, BBP®31, BBP®33, BBP®35 and BBP®37 printers.*



Benchtop Printers



No-hassle, 20-second material changeovers

Forget fumbling around with supplies that roll away or require complicated threading. These easy-to-load materials and ribbons snap into place for easy 20-second material changeovers. Switch materials frequently throughout the day? You'll save time to work on your more important tasks.

Efficient label setup with print smart technology

Your printing team – printer, labels, ribbons and software – all work together from the moment you close the printer cover. It's all in the smart chip embedded in our materials.

When the material is installed, the chip sends vital information such as size, type, color and remaining quantity right to the printer. You'll be ready to print in no time.

Smart chip auto populates:

- Label size and color
- Pre-printed headers
- Remaining material quantity

No wasting labels with auto calibration

The auto calibration that takes place as soon as material is installed, means that you'll be printing on the very first label, saving you valuable time and labels.

B30 / B33 Series

*Supplies listed on the following pages are compatible unless otherwise noted in the part number tables.

The right label from the right company

Nothing leaves Brady's doors without meeting the highest quality standards. Backed by more than 100 years of identification experience and rigorous R&D testing, Brady manufactures materials you can trust.

That strong background of material development allows us to create materials for all of your applications throughout your facility. Add the printing versatility of a Brady printer, and you get a convenient tool for facility-wide identification that offers more than 825 parts and 70 material options, and additional custom label options for a variety of applications, including:

Safety, maintenance and facility applications



Arc Flash Labels



GHS Labels



Safety Labels



Pipe Markers



Inventory ID



Tags



Raised Panel Labels



Floor Marking

Specialty applications with the BradyPrinter i3300



Product ID



Wire and cable markers



Electronics and PC boards



Laboratory labels

Cut-out shapes and text with the BBP[®]37 Printer



Cut-out text



Cut-out shapes



Look for the scissors icon on the following pages for 4 inch wide materials that are compatible with the BBP37 XY-plotter cutter.

(Cut-out text must be 0.75 in. or larger.)

B30- and B33-Series Materials

BradyID.com/s36

Benchtop Printers

B30 / B33 Series

Rigid sign and tag techniques:

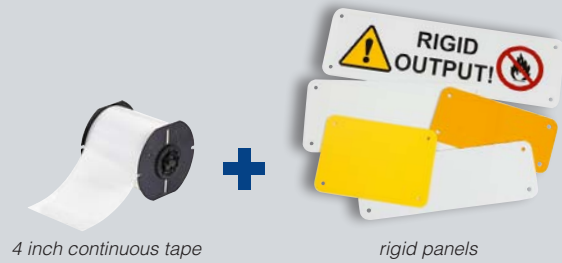

4 inch continuous tape

rigid panels

Blank Rigid Signs

- Create rigid signs and labels with any adhesive-backed output
- Ideal for surfaces where applying an adhesive label is difficult
- Panels can be mounted using foam tape, magnetic strips or by their included pre-drilled corner holes

Blank rigid signs

Color	Panel Height Inch	Panel Length Inch	Aluminum 10/Pack	Plastic 10/Pack
White	2.50	6.25	146083	146076
White	2.50	10.25	146113	146077
White	4.25	6.25	13629	13620
White	4.25	10.25	106461	146074
White	4.25	14.25	146082	146075
Yellow	2.50	6.25	146116	146080
Yellow	2.50	10.25	146117	146081
Yellow	4.25	6.25	13630	13620
Yellow	4.25	10.25	146114	146078
Yellow	4.25	14.25	146115	146079
Orange	4.25	6.25	13631	13622



White die-cut label

Blank tag

Blank Rigid Valve Tags

Print labels on your Brady printer and apply them to industrial-grade plastic tags

- Die-cut labels are sized to fit the recessed area on the tag
- Outdoor tag withstands temperatures -40° F to 180° F

Blank rigid valve tags

Catalog #	Color	Tag Size Inch	Recessed Area Inch
87696	White	2.1 x 3.6	1.5 x 3
87697	White	3.1 x 4.6	2.5 x 4
41922	Yellow	2.1 x 3.6	1.5 x 3
41923	Yellow	3.1 x 4.6	2.5 x 4
41924	Red	2.1 x 3.6	1.5 x 3
41925	Red	3.1 x 4.6	2.5 x 4
41926	Blue	2.1 x 3.6	1.5 x 3
41927	Blue	3.1 x 4.6	2.5 x 4
41928	Green	2.1 x 3.6	1.5 x 3
41929	Green	3.1 x 4.6	2.5 x 4
87694	Orange	2.1 x 3.6	1.5 x 3
87695	Orange	3.1 x 4.6	2.5 x 4
87712	Tan	2.1 x 3.6	1.5 x 3
87713	Tan	3.1 x 4.6	2.5 x 4
87710	Brown	2.1 x 3.6	1.5 x 3
87711	Brown	3.1 x 4.6	2.5 x 4
87698	Gray	2.1 x 3.6	1.5 x 3
87699	Gray	3.1 x 4.6	2.5 x 4
41920	Black	2.1 x 3.6	1.5 x 3
41921	Black	3.1 x 4.6	2.5 x 4
142133	Variety Pack*	-	-

Printing supplies

Fits Printers	Catalog #	Color	Label Size	Labels per Roll
All*	B30-242-595-BLNKWT	White	1.125 in. x 2.75 in. for small tag	300
All*	B30-219-595-BLNKWT	White	2.25 in. x 3.75 in. for large tag	250
All*	B30-R10000	Black	Print Ribbon	-

*Pack of 30 tags includes at least one of each size and color. Perfect for evaluating which sizes and colors you need.

*All supplies listed are compatible with the following printers unless otherwise noted: BradyPrinter S3000, S3100, i3300, BBP®30, BBP®31, BBP®33, BBP®35 and BBP®37 printers.

BBP®37 printer “cutter” labeling techniques



Circle Gauge Labels with the BBP®37 Printer

The XY cutter and built-in Circle Gauge App on the BBP37 printer make it easy to create gauge labels. The app allows you to:

- Create in-zone, out-of-zone, caution zone or all three
- Specify center hole size

How to: Use multi-color ribbons, 4 in. white continuous tape and the XY cutter on the BBP37 printer to print and cut out a circular label for your gauge. Transparent transfer tape then makes it easy to cleanly apply the label in the proper position on your gauge.

Printing supplies – requires BBP37 printer

Catalog #	Color		
B30C-4000-595-WT		White vinyl	4.0 in. x 100 ft.
B30-R10000-GR-8		Green, red ribbon	
B30-R10000-KRYG-8		Black, red, yellow and green ribbon	
B30-R10000-KRGB-8		Black, red, blue and green ribbon	
76737		transfer tape	4.25 in. x 300 ft



Gradient “Ruler” Labels with BBP35 or BBP37 Printers

Create accurate scale or “ruler” labels using the built-in Gradient Label App on the printer with continuous tapes.

The app allows you to:

- Specify units in inches or millimeters
- Choose from several interval tick mark options
- Designate “zones” through multiple color printing
- Set specific starting point

How to: Use any continuous tape along with the built-in Gradient Label App on the BBP35 and BBP37 printers.

Printing supplies – requires BBP35 or BBP37

Catalog #	Color	Size
B30C-4000-595-WT		White vinyl 4.0 in. x 100 ft.
B30C-2250-595-WT		White vinyl 2.25 in. x 100 ft.
B30C-1125-595-WT		White vinyl 1.125 in. x 100 ft.
B30C-500-595-WT		White vinyl 0.50 in. x 100 ft.
B30C-4000-595-YL		Yellow vinyl 4.0 in. x 100 ft.
B30C-2250-595-YL		Yellow vinyl 2.25 in. x 100 ft.
B30C-1125-595-YL		Yellow vinyl 1.125 in. x 100 ft.
B30C-500-595-YL		Yellow vinyl 0.50 in. x 100 ft.
B30-R10000		Black ribbon
B30-R10000-RD		Red ribbon
B30-R10000-KR-8		Black, red ribbon
B30-R10000-KRGB-8		Black, red, green and blue ribbon
B30-R10000-KRYG-8		Black, red, yellow and green ribbon

*All supplies listed are compatible with the following printers unless otherwise noted: BradyPrinter S3000, S3100, i3300, BBP®30, BBP®31, BBP®33, BBP®35 and BBP®37 printers.

B30- and B33-Series Materials

BradyID.com/s36

Indoor and Outdoor Vinyl (B-595)

Continuous vinyl material is ideal for lean / 5S labels, pipe markers, equipment and production area identification. These labels offer excellent resistance to oils, detergents, dirt, grime and many solvents. Permanent adhesive, very pliable, good for rough surfaces and outdoor use.

Service temp: -40° F to 180° F
 Application temp: 0° F to 180° F
 Average outdoor durability: 8-10 years
 Agency approvals: **RoHS**

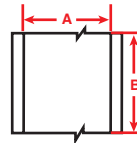

Figure 3



Benchmark Printers

B30 / B33 Series

Fits Printers	Figure	Catalog #	B#	Color	Label Width A Inch (mm)	Roll Length B Feet (m)	Labels Per Roll	Rec. Ribbon
All*	Fig. 3	B30C-500-595-WT	B-595	White	0.500 (12.7)	100 (30.5)	1 roll (cont.)	B30-R10000
All*	Fig. 3	B30C-1125-595-WT	B-595	White	1.125 (28.6)	100 (30.5)	1 roll (cont.)	B30-R10000
All*	Fig. 3	B30C-2250-595-WT	B-595	White	2.250 (57.5)	100 (30.5)	1 roll (cont.)	B30-R10000
All*	Fig. 3	B30C-3000-595-WT	B-595	White	3.000 (76.2)	100 (30.5)	1 roll (cont.)	B30-R10000
All* ✂	Fig. 3	B30C-4000-595-WT	B-595	White	4.000 (101.6)	100 (30.5)	1 roll (cont.)	B30-R10000
All*	Fig. 3	B30C-500-595-YL	B-595	Yellow	0.500 (12.7)	100 (30.5)	1 roll (cont.)	B30-R10000
All*	Fig. 3	B30C-1125-595-YL	B-595	Yellow	1.125 (28.6)	100 (30.5)	1 roll (cont.)	B30-R10000
All*	Fig. 3	B30C-2250-595-YL	B-595	Yellow	2.250 (57.5)	100 (30.5)	1 roll (cont.)	B30-R10000
All*	Fig. 3	B30C-3000-595-YL	B-595	Yellow	3.000 (76.2)	100 (30.5)	1 roll (cont.)	B30-R10000
All* ✂	Fig. 3	B30C-4000-595-YL	B-595	Yellow	4.000 (101.6)	100 (30.5)	1 roll (cont.)	B30-R10000
All*	Fig. 3	B30C-500-595-RD	B-595	Red	0.500 (12.7)	100 (30.5)	1 roll (cont.)	B30-R10000-WT
All*	Fig. 3	B30C-1125-595-RD	B-595	Red	1.125 (28.6)	100 (30.5)	1 roll (cont.)	B30-R10000-WT
All*	Fig. 3	B30C-2250-595-RD	B-595	Red	2.250 (57.5)	100 (30.5)	1 roll (cont.)	B30-R10000-WT
All* ✂	Fig. 3	B30C-4000-595-RD	B-595	Red	4.000 (101.6)	100 (30.5)	1 roll (cont.)	B30-R10000-WT
All*	Fig. 3	B30C-500-595-BL	B-595	Blue	0.500 (12.7)	100 (30.5)	1 roll (cont.)	B30-R10000-WT
All*	Fig. 3	B30C-1125-595-BL	B-595	Blue	1.125 (28.6)	100 (30.5)	1 roll (cont.)	B30-R10000-WT
All*	Fig. 3	B30C-2250-595-BL	B-595	Blue	2.250 (57.5)	100 (30.5)	1 roll (cont.)	B30-R10000-WT
All* ✂	Fig. 3	B30C-4000-595-BL	B-595	Blue	4.000 (101.6)	100 (30.5)	1 roll (cont.)	B30-R10000-WT
All*	Fig. 3	B30C-500-595-GN	B-595	Green	0.500 (12.7)	100 (30.5)	1 roll (cont.)	B30-R10000-WT
All*	Fig. 3	B30C-1125-595-GN	B-595	Green	1.125 (28.6)	100 (30.5)	1 roll (cont.)	B30-R10000-WT
All*	Fig. 3	B30C-2250-595-GN	B-595	Green	2.250 (57.5)	100 (30.5)	1 roll (cont.)	B30-R10000-WT
All* ✂	Fig. 3	B30C-4000-595-GN	B-595	Green	4.000 (101.6)	100 (30.5)	1 roll (cont.)	B30-R10000-WT
All*	Fig. 3	B30C-500-595-OR	B-595	Orange	0.500 (12.7)	100 (30.5)	1 roll (cont.)	B30-R10000
All*	Fig. 3	B30C-1125-595-OR	B-595	Orange	1.125 (28.6)	100 (30.5)	1 roll (cont.)	B30-R10000
All*	Fig. 3	B30C-2250-595-OR	B-595	Orange	2.250 (57.5)	100 (30.5)	1 roll (cont.)	B30-R10000
All* ✂	Fig. 3	B30C-4000-595-OR	B-595	Orange	4.000 (101.6)	100 (30.5)	1 roll (cont.)	B30-R10000
All*	Fig. 3	B30C-500-595-BK	B-595	Black	0.500 (12.7)	100 (30.5)	1 roll (cont.)	B30-R10000-WT
All*	Fig. 3	B30C-1125-595-BK	B-595	Black	1.125 (28.6)	100 (30.5)	1 roll (cont.)	B30-R10000-WT
All*	Fig. 3	B30C-2250-595-BK	B-595	Black	2.250 (57.5)	100 (30.5)	1 roll (cont.)	B30-R10000-WT
All* ✂	Fig. 3	B30C-4000-595-BK	B-595	Black	4.000 (101.6)	100 (30.5)	1 roll (cont.)	B30-R10000-WT
All*	Fig. 3	B30C-500-595-BR	B-595	Brown	0.500 (12.7)	100 (30.5)	1 roll (cont.)	B30-R10000-WT
All*	Fig. 3	B30C-1125-595-BR	B-595	Brown	1.125 (28.6)	100 (30.5)	1 roll (cont.)	B30-R10000-WT
All*	Fig. 3	B30C-2250-595-BR	B-595	Brown	2.250 (57.5)	100 (30.5)	1 roll (cont.)	B30-R10000-WT
All* ✂	Fig. 3	B30C-4000-595-BR	B-595	Brown	4.000 (101.6)	100 (30.5)	1 roll (cont.)	B30-R10000-WT
All*	Fig. 3	B30C-1125-595-OC	B-595	Ochre	1.125 (28.6)	100 (30.5)	1 roll (cont.)	B30-R10000
All*	Fig. 3	B30C-2250-595-OC	B-595	Ochre	2.250 (57.5)	100 (30.5)	1 roll (cont.)	B30-R10000
All* ✂	Fig. 3	B30C-4000-595-OC	B-595	Ochre	4.000 (101.6)	100 (30.5)	1 roll (cont.)	B30-R10000
All*	Fig. 3	B30C-500-595-GD	B-595	Gold	0.500 (12.7)	100 (30.5)	1 roll (cont.)	B30-R10000
All*	Fig. 3	B30C-1125-595-GD	B-595	Gold	1.125 (28.6)	100 (30.5)	1 roll (cont.)	B30-R10000
All*	Fig. 3	B30C-2250-595-GD	B-595	Gold	2.250 (57.5)	100 (30.5)	1 roll (cont.)	B30-R10000
All* ✂	Fig. 3	B30C-4000-595-GD	B-595	Gold	4.000 (101.6)	100 (30.5)	1 roll (cont.)	B30-R10000
All*	Fig. 3	B30C-500-595-GY	B-595	Gray	0.500 (12.7)	100 (30.5)	1 roll (cont.)	B30-R10000
All*	Fig. 3	B30C-1125-595-GY	B-595	Gray	1.125 (28.6)	100 (30.5)	1 roll (cont.)	B30-R10000
All*	Fig. 3	B30C-2250-595-GY	B-595	Gray	2.250 (57.5)	100 (30.5)	1 roll (cont.)	B30-R10000
All* ✂	Fig. 3	B30C-4000-595-GY	B-595	Gray	4.000 (101.6)	100 (30.5)	1 roll (cont.)	B30-R10000
All*	Fig. 3	B30C-500-595-PL	B-595	Purple	0.500 (12.7)	100 (30.5)	1 roll (cont.)	B30-R10000-WT
All*	Fig. 3	B30C-1125-595-PL	B-595	Purple	1.125 (28.6)	100 (30.5)	1 roll (cont.)	B30-R10000-WT
All*	Fig. 3	B30C-2250-595-PL	B-595	Purple	2.250 (57.5)	100 (30.5)	1 roll (cont.)	B30-R10000-WT
All* ✂	Fig. 3	B30C-4000-595-PL	B-595	Purple	4.000 (101.6)	100 (30.5)	1 roll (cont.)	B30-R10000-WT
All*	Fig. 3	B30C-500-595-CL	B-595	Clear	0.500 (12.7)	100 (30.5)	1 roll (cont.)	B30-R10000
All*	Fig. 3	B30C-1125-595-CL	B-595	Clear	1.125 (28.6)	100 (30.5)	1 roll (cont.)	B30-R10000
All*	Fig. 3	B30C-2250-595-CL	B-595	Clear	2.250 (57.5)	100 (30.5)	1 roll (cont.)	B30-R10000
All* ✂	Fig. 3	B30C-4000-595-CL	B-595	Clear	4.000 (101.6)	100 (30.5)	1 roll (cont.)	B30-R10000

U.S. Patent No. 5,823,689; 6,570,602. Additional patents pending.

✂ Compatible with BBP37 XY cutter.

*All supplies listed are compatible with the following printers unless otherwise noted: BradyPrinter S3000, S3100, i3300, BBP®30, BBP®31, BBP®33, BBP®35 and BBP®37 printers.

B30- and B33-Series Materials

BradyID.com/s36

Low-Halide Polyester (B-569)

Low-halide content for labeling stainless steel pipes and surfaces.
Applies best to very smooth surfaces and ideal for mounting to rigid panels.

Service temp: -40° F to 212° F
Application temp: 0° F to 212° F
Average outdoor durability: 3-5 years

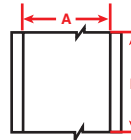

Figure 3



Fits Printers	Figure	Catalog #	B#	Color	Label Width A Inch (mm)	Roll Length B Feet (m)	Labels Per Roll	Rec. Ribbon
All*	Fig. 3	B30C-500-569-WT	B-569	White	0.500 (12.7)	100 (30.5)	1 roll (cont.)	B30-R10000
All*	Fig. 3	B30C-1125-569-WT	B-569	White	1.125 (28.6)	100 (30.5)	1 roll (cont.)	B30-R10000
All*	Fig. 3	B30C-2250-569-WT	B-569	White	2.250 (57.5)	100 (30.5)	1 roll (cont.)	B30-R10000
All*	Fig. 3	B30C-3000-569-WT	B-569	White	3.000 (76.2)	100 (30.5)	1 roll (cont.)	B30-R10000
All* ✂	Fig. 3	B30C-4000-569-WT	B-569	White	4.000 (101.6)	100 (30.5)	1 roll (cont.)	B30-R10000
All*	Fig. 3	B30C-500-569-YL	B-569	Yellow	0.500 (12.7)	100 (30.5)	1 roll (cont.)	B30-R10000
All*	Fig. 3	B30C-1125-569-YL	B-569	Yellow	1.125 (28.6)	100 (30.5)	1 roll (cont.)	B30-R10000
All*	Fig. 3	B30C-2250-569-YL	B-569	Yellow	2.250 (57.5)	100 (30.5)	1 roll (cont.)	B30-R10000
All* ✂	Fig. 3	B30C-4000-569-YL	B-569	Yellow	4.000 (101.6)	100 (30.5)	1 roll (cont.)	B30-R10000
All*	Fig. 3	B30C-500-569-RD	B-569	Red	0.500 (12.7)	100 (30.5)	1 roll (cont.)	B30-R10000-WT
All*	Fig. 3	B30C-1125-569-RD	B-569	Red	1.125 (28.6)	100 (30.5)	1 roll (cont.)	B30-R10000-WT
All*	Fig. 3	B30C-2250-569-RD	B-569	Red	2.250 (57.5)	100 (30.5)	1 roll (cont.)	B30-R10000-WT
All* ✂	Fig. 3	B30C-4000-569-RD	B-569	Red	4.000 (101.6)	100 (30.5)	1 roll (cont.)	B30-R10000-WT
All*	Fig. 3	B30C-500-569-BL	B-569	Blue	0.500 (12.7)	100 (30.5)	1 roll (cont.)	B30-R10000-WT
All*	Fig. 3	B30C-1125-569-BL	B-569	Blue	1.125 (28.6)	100 (30.5)	1 roll (cont.)	B30-R10000-WT
All*	Fig. 3	B30C-2250-569-BL	B-569	Blue	2.250 (57.5)	100 (30.5)	1 roll (cont.)	B30-R10000-WT
All* ✂	Fig. 3	B30C-4000-569-BL	B-569	Blue	4.000 (101.6)	100 (30.5)	1 roll (cont.)	B30-R10000-WT
All*	Fig. 3	B30C-500-569-LB	B-569	Light Blue	0.500 (12.7)	100 (30.5)	1 roll (cont.)	B30-R10000
All*	Fig. 3	B30C-1125-569-LB	B-569	Light Blue	1.125 (28.6)	100 (30.5)	1 roll (cont.)	B30-R10000
All*	Fig. 3	B30C-2250-569-LB	B-569	Light Blue	2.250 (57.5)	100 (30.5)	1 roll (cont.)	B30-R10000
All* ✂	Fig. 3	B30C-4000-569-LB	B-569	Light Blue	4.000 (101.6)	100 (30.5)	1 roll (cont.)	B30-R10000
All*	Fig. 3	B30C-500-569-SB	B-569	Sky Blue	0.500 (12.7)	100 (30.5)	1 roll (cont.)	B30-R10000
All*	Fig. 3	B30C-1125-569-SB	B-569	Sky Blue	1.125 (28.6)	100 (30.5)	1 roll (cont.)	B30-R10000
All*	Fig. 3	B30C-2250-569-SB	B-569	Sky Blue	2.250 (57.5)	100 (30.5)	1 roll (cont.)	B30-R10000
All* ✂	Fig. 3	B30C-4000-569-SB	B-569	Sky Blue	4.000 (101.6)	100 (30.5)	1 roll (cont.)	B30-R10000
All*	Fig. 3	B30C-500-569-GN	B-569	Green	0.500 (12.7)	100 (30.5)	1 roll (cont.)	B30-R10000-WT
All*	Fig. 3	B30C-1125-569-GN	B-569	Green	1.125 (28.6)	100 (30.5)	1 roll (cont.)	B30-R10000-WT
All*	Fig. 3	B30C-2250-569-GN	B-569	Green	2.250 (57.5)	100 (30.5)	1 roll (cont.)	B30-R10000-WT
All* ✂	Fig. 3	B30C-4000-569-GN	B-569	Green	4.000 (101.6)	100 (30.5)	1 roll (cont.)	B30-R10000-WT
All*	Fig. 3	B30C-500-569-OR	B-569	Orange	0.500 (12.7)	100 (30.5)	1 roll (cont.)	B30-R10000
All*	Fig. 3	B30C-1125-569-OR	B-569	Orange	1.125 (28.6)	100 (30.5)	1 roll (cont.)	B30-R10000
All*	Fig. 3	B30C-2250-569-OR	B-569	Orange	2.250 (57.5)	100 (30.5)	1 roll (cont.)	B30-R10000
All* ✂	Fig. 3	B30C-4000-569-OR	B-569	Orange	4.000 (101.6)	100 (30.5)	1 roll (cont.)	B30-R10000
All*	Fig. 3	B30C-500-569-BK	B-569	Black	0.500 (12.7)	100 (30.5)	1 roll (cont.)	B30-R10000-WT
All*	Fig. 3	B30C-1125-569-BK	B-569	Black	1.125 (28.6)	100 (30.5)	1 roll (cont.)	B30-R10000-WT
All*	Fig. 3	B30C-2250-569-BK	B-569	Black	2.250 (57.5)	100 (30.5)	1 roll (cont.)	B30-R10000-WT
All* ✂	Fig. 3	B30C-4000-569-BK	B-569	Black	4.000 (101.6)	100 (30.5)	1 roll (cont.)	B30-R10000-WT
All*	Fig. 3	B30C-500-569-BR	B-569	Brown	0.500 (12.7)	100 (30.5)	1 roll (cont.)	B30-R10000-WT
All*	Fig. 3	B30C-1125-569-BR	B-569	Brown	1.125 (28.6)	100 (30.5)	1 roll (cont.)	B30-R10000-WT
All*	Fig. 3	B30C-2250-569-BR	B-569	Brown	2.250 (57.5)	100 (30.5)	1 roll (cont.)	B30-R10000-WT
All* ✂	Fig. 3	B30C-4000-569-BR	B-569	Brown	4.000 (101.6)	100 (30.5)	1 roll (cont.)	B30-R10000-WT
All*	Fig. 3	B30C-500-569-OC	B-569	Ochre	0.500 (12.7)	100 (30.5)	1 roll (cont.)	B30-R10000
All*	Fig. 3	B30C-1125-569-OC	B-569	Ochre	1.125 (28.6)	100 (30.5)	1 roll (cont.)	B30-R10000
All*	Fig. 3	B30C-2250-569-OC	B-569	Ochre	2.250 (57.5)	100 (30.5)	1 roll (cont.)	B30-R10000
All* ✂	Fig. 3	B30C-4000-569-OC	B-569	Ochre	4.000 (101.6)	100 (30.5)	1 roll (cont.)	B30-R10000
All*	Fig. 3	B30C-500-569-TN	B-569	Tan	0.500 (12.7)	100 (30.5)	1 roll (cont.)	B30-R10000
All*	Fig. 3	B30C-1125-569-TN	B-569	Tan	1.125 (28.6)	100 (30.5)	1 roll (cont.)	B30-R10000
All*	Fig. 3	B30C-2250-569-TN	B-569	Tan	2.250 (57.5)	100 (30.5)	1 roll (cont.)	B30-R10000
All* ✂	Fig. 3	B30C-4000-569-TN	B-569	Tan	4.000 (101.6)	100 (30.5)	1 roll (cont.)	B30-R10000
All*	Fig. 3	B30C-500-569-GY	B-569	Gray	0.500 (12.7)	100 (30.5)	1 roll (cont.)	B30-R10000
All*	Fig. 3	B30C-1125-569-GY	B-569	Gray	1.125 (28.6)	100 (30.5)	1 roll (cont.)	B30-R10000
All*	Fig. 3	B30C-2250-569-GY	B-569	Gray	2.250 (57.5)	100 (30.5)	1 roll (cont.)	B30-R10000
All* ✂	Fig. 3	B30C-4000-569-GY	B-569	Gray	4.000 (101.6)	100 (30.5)	1 roll (cont.)	B30-R10000
All*	Fig. 3	B30C-500-569-PL	B-569	Purple	0.500 (12.7)	100 (30.5)	1 roll (cont.)	B30-R10000-WT
All*	Fig. 3	B30C-1125-569-PL	B-569	Purple	1.125 (28.6)	100 (30.5)	1 roll (cont.)	B30-R10000-WT
All*	Fig. 3	B30C-2250-569-PL	B-569	Purple	2.250 (57.5)	100 (30.5)	1 roll (cont.)	B30-R10000-WT
All* ✂	Fig. 3	B30C-4000-569-PL	B-569	Purple	4.000 (101.6)	100 (30.5)	1 roll (cont.)	B30-R10000-WT
All*	Fig. 3	B30C-500-569-PK	B-569	Pink	0.500 (12.7)	100 (30.5)	1 roll (cont.)	B30-R10000
All*	Fig. 3	B30C-1125-569-PK	B-569	Pink	1.125 (28.6)	100 (30.5)	1 roll (cont.)	B30-R10000
All*	Fig. 3	B30C-2250-569-PK	B-569	Pink	2.250 (57.5)	100 (30.5)	1 roll (cont.)	B30-R10000
All* ✂	Fig. 3	B30C-4000-569-PK	B-569	Pink	4.000 (101.6)	100 (30.5)	1 roll (cont.)	B30-R10000
All*	Fig. 3	B30C-500-569-CL	B-569	Clear	0.500 (12.7)	100 (30.5)	1 roll (cont.)	B30-R10000
All*	Fig. 3	B30C-1125-569-CL	B-569	Clear	1.125 (28.6)	100 (30.5)	1 roll (cont.)	B30-R10000
All*	Fig. 3	B30C-2250-569-CL	B-569	Clear	2.250 (57.5)	100 (30.5)	1 roll (cont.)	B30-R10000
All* ✂	Fig. 3	B30C-4000-569-CL	B-569	Clear	4.000 (101.6)	100 (30.5)	1 roll (cont.)	B30-R10000

✂ Compatible with BBP37 XY cutter.

*All supplies listed are compatible with the following printers unless otherwise noted:
BradyPrinter S3000, S3100, i3300, BBP®30, BBP®31, BBP®33, BBP®35 and BBP®37 printers.

B30- and B33-Series Materials

BradyID.com/s36

Pre-Printed GHS / CLP Chemical Labels (B-569 and B-7569)

- Blank labels with pre-printed red diamonds allow the printer to produce two-color GHS / CLP labels in one print pass
- Three sizes of labels, each with diamond layouts that match templates in the printer app (if applicable) or in the Brady Workstation GHS App
- Indoor / outdoor vinyl material and durable inks withstand exposure to moisture, chemicals and handling

Service temp: -4° F to 180° F
 Application temp: 50° F to 180° F
 Average outdoor durability: 3-5 years



Benchtop Printers

B30 / B33 Series

Fits Printers	Catalog #	B#	Material	Legend	Label Height Inch (mm)	Label Width Inch (mm)	Labels Per Roll	Rec. Ribbon
All*	B30-260-7569-CLP1	B-7569	Vinyl		2.170 (55.0)	3.350 (85.0)	340	B30-R10000
All*	B30-261-7569-CLP1	B-7569	Vinyl		2.950 (75.0)	4.330 (110.0)	270	B30-R10000
All*	B30-262-7569-CLP1	B-7569	Vinyl		4.130 (105.0)	6.100 (155.0)	200	B30-R10000
All*	B30-260-7569-CLP2	B-7569	Vinyl		2.170 (55.0)	3.350 (85.0)	340	B30-R10000
All*	B30-261-7569-CLP2	B-7569	Vinyl		2.950 (75.0)	4.330 (110.0)	270	B30-R10000
All*	B30-262-7569-CLP2	B-7569	Vinyl		4.130 (105.0)	6.100 (155.0)	200	B30-R10000
All*	B30-260-7569-CLP3A	B-7569	Vinyl		2.170 (55.0)	3.350 (85.0)	340	B30-R10000
All*	B30-261-7569-CLP3A	B-7569	Vinyl		2.950 (75.0)	4.330 (110.0)	270	B30-R10000
All*	B30-262-7569-CLP3A	B-7569	Vinyl		4.130 (105.0)	6.100 (155.0)	200	B30-R10000
All*	B30-260-7569-CLP3B	B-7569	Vinyl		2.170 (55.0)	3.350 (85.0)	340	B30-R10000
All*	B30-261-7569-CLP3B	B-7569	Vinyl		2.950 (75.0)	4.330 (110.0)	270	B30-R10000
All*	B30-262-7569-CLP3B	B-7569	Vinyl		4.130 (105.0)	6.100 (155.0)	200	B30-R10000
All*	B30-260-7569-CLP4A	B-7569	Vinyl		2.170 (55.0)	3.350 (85.0)	340	B30-R10000
All*	B30-261-7569-CLP4A	B-7569	Vinyl		2.950 (75.0)	4.330 (110.0)	270	B30-R10000
All*	B30-262-7569-CLP4A	B-7569	Vinyl		4.130 (105.0)	6.100 (155.0)	200	B30-R10000
All*	B30-260-569-CLP4B	B-569	Polyester		2.170 (55.0)	3.350 (85.0)	340	B30-R10000
All*	B30-260-7569-CLP4B	B-7569	Vinyl		2.170 (55.0)	3.350 (85.0)	340	B30-R10000
All*	B30-261-569-CLP4B	B-569	Polyester		2.950 (75.0)	4.330 (110.0)	270	B30-R10000
All*	B30-261-7569-CLP4B	B-7569	Vinyl		2.950 (75.0)	4.330 (110.0)	270	B30-R10000
All*	B30-262-569-CLP4B	B-569	Polyester		4.130 (105.0)	6.100 (155.0)	200	B30-R10000
All*	B30-262-7569-CLP4B	B-7569	Vinyl		4.130 (105.0)	6.100 (155.0)	200	B30-R10000
All*	B30-18-7569-CLP4C	B-7569	Vinyl		1.000 (25.4)	3.000 (76.2)	1000	B30-R10000

Easily design GHS labels with the Brady Workstation GHS App

- Select from built-in pre-formatted label layouts with GHS symbols
- Search the built-in chemical database by CAS number to auto-populate your label, then edit to meet your specific SDS
- Print any of the six template sizes



Learn more at Workstation.BradyID.com

*All supplies listed are compatible with the following printers unless otherwise noted: BradyPrinter S3000, S3100, i3300, BBP®30, BBP®31, BBP®33, BBP®35 and BBP®37 printers.

B30- and B33-Series Materials

BradyID.com/s36

Pre-Printed Right-To-Know Chemical Labels (B-595)

- Pre-printed labels result in 5-color chemical labels in a single print pass
- Indoor / outdoor grade vinyl withstands exposure to moisture, chemicals and handling

Service temp: -40° F to 180° F

Application temp: 0° F to 180° F

Average outdoor durability: 8 to 10 years

Agency approvals: **RoHS**



Fits Printers	Catalog #	B#	Legend	Label Height Inch (mm)	Label Width Inch (mm)	Labels Per Row	Labels Per Roll	Rec. Ribbon
S3100, i3300, BBP31, BBP33, BBP35, BBP37	B30-244-595-NFPA	B-595		2.250 (57.5)	2.250 (57.5)	1	365	B30-R10000
S3100, i3300, BBP31, BBP33, BBP35, BBP37	B30-245-595-NFPA	B-595		2.250 (57.5)	4.000 (101.6)	1	240	B30-R10000
S3100, i3300, BBP31, BBP33, BBP35, BBP37	B30-263-595-NFPA	B-595		4.000 (101.6)	6.250 (158.8)	1	170	B30-R10000
S3100, i3300, BBP31, BBP33, BBP35, BBP37	B30-244-595-DIAM	B-595		2.250 (57.5)	2.250 (57.5)	1	365	B30-R10000
S3100, i3300, BBP31, BBP33, BBP35, BBP37	B30-161-595-DIAM	B-595		4.000 (101.6)	4.000 (101.6)	1	240	B30-R10000
S3100, i3300, BBP31, BBP33, BBP35, BBP37	B30-246-595-NFR	B-595		1.125 (28.6)	3.000 (76.2)	1	300	B30-R10000
S3100, i3300, BBP31, BBP33, BBP35, BBP37	B30-244-595-CB	B-595		2.250 (57.5)	2.250 (57.5)	1	365	B30-R10000
S3100, i3300, BBP31, BBP33, BBP35, BBP37	B30-245-595-CB	B-595		2.250 (57.5)	4.000 (101.6)	1	240	B30-R10000
S3100, i3300, BBP31, BBP33, BBP35, BBP37	B30-263-595-CB	B-595		4.000 (101.6)	6.250 (158.8)	1	170	B30-R10000
S3100, i3300, BBP31, BBP33, BBP35, BBP37	B30-244-595-HMIG	B-595		2.250 (57.5)	2.250 (57.5)	1	365	B30-R10000
S3100, i3300, BBP31, BBP33, BBP35, BBP37	B30-246-595-HMIG	B-595		1.125 (28.6)	3.000 (76.2)	1	300	B30-R10000

Labels above are not compatible with BradyPrinter S3000 or BBP30 printers.

Benchtop Printers

B30 / B33 Series

B30- and B33-Series Materials

BradyID.com/s36

Pre-Printed Pre-Cut Blank Sign Headers (B-595)

- Allows printer to create multicolor signs fast in a single print pass
- Headers meet NFPA 70E, OSHA 1910.145 and ASME/ANSI Z535 standards
- Indoor / outdoor grade vinyl conforms to rough, highly textured and difficult-to-adhere-to surfaces

Service temp: -40° F to 180° F
 Application temp: 0° F to 180° F
 Average outdoor durability: 8-10 years
 Agency approvals: **RoHS**

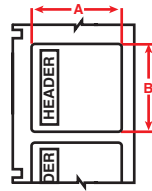

Figure 70

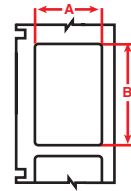

Figure 82



Blank rigid valve tags on page 38

Benchmark Printers

Fits Printers	Figure	Catalog #	B#	Header	Label Height A Inch (mm)	Label Width B Inch (mm)	Labels Per Roll	Rec. Ribbon
All*	Fig. 70	B30-241-595-OSHADA	B-595		2.250 (57.5)	3.000 (76.2)	300	B30-R10000
All*	Fig. 70	B30-25-595-OSHADA	B-595		4.000 (101.6)	6.000 (152.4)	175	B30-R10000
All*	Fig. 70	B30-241-595-OSHACA	B-595		2.250 (57.5)	3.000 (76.2)	300	B30-R10000
All*	Fig. 70	B30-25-595-OSHACA	B-595		4.000 (101.6)	6.000 (152.4)	175	B30-R10000
All*	Fig. 70	B30-241-595-ANSICA	B-595		2.250 (57.5)	3.000 (76.2)	300	B30-R10000
All*	Fig. 70	B30-25-595-ANSICA	B-595		4.000 (101.6)	6.000 (152.4)	175	B30-R10000
All*	Fig. 70	B30-241-595-ANSIDA	B-595		2.250 (57.5)	3.000 (76.2)	300	B30-R10000
All*	Fig. 70	B30-25-595-ANSIDA	B-595		4.000 (101.6)	6.000 (152.4)	175	B30-R10000
All*	Fig. 70	B30-241-595-ANSIWA	B-595		2.250 (57.5)	3.000 (76.2)	300	B30-R10000
All*	Fig. 70	B30-25-595-ANSIWA	B-595		4.000 (101.6)	6.000 (152.4)	175	B30-R10000
All*	Fig. 70	B30-241-595-ANSINO	B-595		2.250 (57.5)	3.000 (76.2)	300	B30-R10000
All*	Fig. 70	B30-25-595-ANSINO	B-595		4.000 (101.6)	6.000 (152.4)	175	B30-R10000
All*	Fig. 70	B30-25-595-PREC	B-595		4.000 (101.6)	6.000 (152.4)	175	B30-R10000
All*	Fig. 70	B30-25-595-PEL	B-595		4.000 (101.6)	6.000 (152.4)	175	B30-R10000
All*	Fig. 82	B30-242-595-BLNKWT	B-595		1.125 (28.6) **	2.750 (69.8)	300	B30-R10000
All*	Fig. 82	B30-241-595-BLNKWT	B-595		2.250 (57.5)	3.000 (76.2)	300	B30-R10000
All*	Fig. 82	B30-219-595-BLNKWT	B-595		2.250 (57.5) **	3.750 (95.3)	250	B30-R10000
All*	Fig. 82	B30-25-595-BLNKWT	B-595		4.000 (101.6)	6.000 (152.4)	175	B30-R10000
All*	Fig. 82	B30-241-595-BLNKYL	B-595		2.250 (57.5)	3.000 (76.2)	300	B30-R10000
All*	Fig. 82	B30-25-595-BLNKYL	B-595		4.000 (101.6)	6.000 (152.4)	175	B30-R10000

** Sized to fit blank rigid valve tags, see page 38.

Non-Adhesive Tags (B-551)

- Non-adhesive semi-rigid card stock in pre-cut or continuous styles
- Pre-cut style tags micro-perforated between tags to separate cleanly and feature chamfered corners
- Snap-in plastic grommets available for extra strength around mounting hole (Catalog #20596, 100/bag)

Service temp: -40° F to 193° F
 Average outdoor durability: Up to 2 years

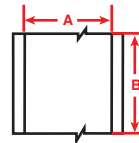

Figure 3

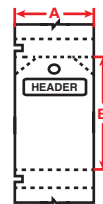

Figure 69



B30 / B33 Series

Fits Printers	Figure	Catalog #	B#	Header	Tag Width A Inch (mm)	Tag Height B Inch (mm)	Tags Per Roll	Rec. Ribbon
All*	Fig. 69	B30-255-551-ANSIDA	B-551		3.250 (82.6)	5.750 (146.1)	100	B30-R10000
All*	Fig. 69	B30-255-551-OSHADA	B-551		3.250 (82.6)	5.750 (146.1)	100	B30-R10000
All*	Fig. 69	B30-255-551-ANSICA	B-551		3.250 (82.6)	5.750 (146.1)	100	B30-R10000
All*	Fig. 69	B30-255-551-WHT	B-551		3.250 (82.6)	5.750 (146.1)	100	B30-R10000
All*	Fig. 3	B30C-2500-551-WT	B-551		2.500 (63.5)	50 ft. (15.2 m)	1 roll (cont.)	B30-R10000
All*	Fig. 3	B30C-3250-551-WT	B-551		3.250 (82.6)	50 ft. (15.2 m)	1 roll (cont.)	B30-R10000
All*	Fig. 3	B30C-4250-551-WT	B-551		4.250 (107.9)	50 ft. (15.2 m)	1 roll (cont.)	B30-R10000

✕ Compatible with BBP37 XY cutter.

*All supplies listed are compatible with the following printers unless otherwise noted: BradyPrinter S3000, S3100, i3300, BBP®30, BBP®31, BBP®33, BBP®35 and BBP®37 printers.

B30- and B33-Series Materials

BradyID.com/s36

ToughWash® Washdown Resistant Labels (B-854 and B-855)

- Withstands high pressure, heat, harsh chemicals and numerous washdown cycles
- Legible and long-lasting for even the toughest washdown cycles
- Ideal for use in the food and beverage industry
- B-854 offers metal detectable layer to allow detection in food stream

Service temp: -40° F to 230° F
Agency approvals: RoHS

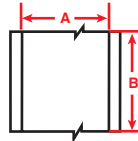

Figure 3

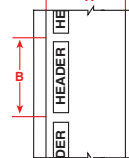

Figure 73



Fits Printers	Figure	Catalog #	B#	Color	Label Width A Inch (mm)	Length B Inch (mm)	Labels Per Roll	Rec. Ribbon
ToughWash Metal Detectable Material (B-854):								
All*	Fig. 3	B30C-4000-854-YL	B-854		4.000 (101.06)	50 ft. (15.2 m)	1 roll (cont.)	B30-R6000
All*	Fig. 3	B30C-4000-854-WT	B-854		4.000 (101.06)	50 ft. (15.2 m)	1 roll (cont.)	B30-R6000
All*	Fig. 73	B30-25-854-OSHADA	B-854		4.000 (101.06)	6.250 (158.8)	100	B30-R6000
All*	Fig. 73	B30-25-854-ANSIWA	B-854		4.000 (101.06)	6.250 (158.8)	100	B30-R6000
All*	Fig. 73	B30-25-854-ANSIDA	B-854		4.000 (101.06)	6.250 (158.8)	100	B30-R6000
All*	Fig. 73	B30-25-854-ANSICA	B-854		4.000 (101.06)	6.250 (158.8)	100	B30-R6000
All*	Fig. 73	B30-25-854-PEL	B-854		4.000 (101.06)	6.250 (158.8)	100	B30-R6000
All*	Fig. 73	B30-25-854-PREC	B-854		4.000 (101.06)	6.250 (158.8)	100	B30-R6000
ToughWash Material (B-855):								
All*	Fig. 3	B30C-1125-855-YL	B-855		1.125 (28.6)	50 ft. (15.2 m)	1 roll (cont.)	B30-R6000
All*	Fig. 3	B30C-2250-855-YL	B-855		2.250 (57.5)	50 ft. (15.2 m)	1 roll (cont.)	B30-R6000
All*	Fig. 3	B30C-4000-855-YL	B-855		4.000 (101.06)	50 ft. (15.2 m)	1 roll (cont.)	B30-R6000
All*	Fig. 3	B30C-1125-855-WT	B-855		1.125 (28.6)	50 ft. (15.2 m)	1 roll (cont.)	B30-R6000
All*	Fig. 3	B30C-2250-855-WT	B-855		2.250 (57.5)	50 ft. (15.2 m)	1 roll (cont.)	B30-R6000
All*	Fig. 3	B30C-4000-855-WT	B-855		4.000 (101.06)	50 ft. (15.2 m)	1 roll (cont.)	B30-R6000
All*	Fig. 73	B30-25-855-OSHADA	B-855		4.000 (101.06)	6.250 (158.8)	100	B30-R6000
All*	Fig. 73	B30-25-855-ANSIWA	B-855		4.000 (101.06)	6.250 (158.8)	100	B30-R6000
All*	Fig. 73	B30-25-855-ANSIDA	B-855		4.000 (101.06)	6.250 (158.8)	100	B30-R6000
All*	Fig. 73	B30-25-855-ANSICA	B-855		4.000 (101.06)	6.250 (158.8)	100	B30-R6000
All*	Fig. 73	B30-25-855-PEL	B-855		4.000 (101.06)	6.250 (158.8)	100	B30-R6000
All*	Fig. 73	B30-25-855-PREC	B-855		4.000 (101.06)	6.250 (158.8)	100	B30-R6000

✕ Compatible with BBP37 XY cutter.

*All supplies listed are compatible with the following printers unless otherwise noted:
BradyPrinter S3000, S3100, i3300, BBP®30, BBP®31, BBP®33, BBP®35 and BBP®37 printers.

B30- and B33-Series Materials

BradyID.com/s36

Chemical and Solvent Resistant Polypropylene Labels (B-425, B-7425)

- Outstanding chemical and solvent resistance and print performance
- Not recommended for prolonged outdoor use

B-425: Service temp: -94° F to 212° F
 B-7425: Service temp: -320° F to 248° F
 Agency approvals:

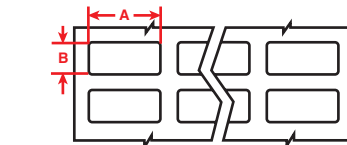

Figure 1

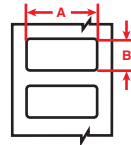

Figure 2

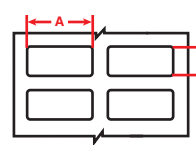

Figure 25



Benchtop Printers

Fits Printers	Figure	Catalog #	B#	Color	Label Width A Inch (mm)	Label Height B Inch (mm)	Labels Per Row	Labels Per Roll	Rec. Ribbon
i3300, BBP33	Fig. 1	B33-5-425	B-425	White	1.000 (25.4)	0.500 (12.7)	3	5000	B30-R4300
i3300, BBP33	Fig. 2	B33-17-425	B-425	White	2.000 (50.8)	1.000 (25.4)	1	1500	B30-R4300
i3300, BBP33	Fig. 2	B33-18-425	B-425	White	3.000 (76.2)	1.000 (25.4)	1	1500	B30-R4300
i3300, BBP33	Fig. 2	B33-19-425	B-425	White	3.000 (76.2)	2.000 (50.8)	1	500	B30-R4300
i3300, BBP33	Fig. 25	B33-88-7425	B-7425	White	1.000 (25.4)	0.750 (19.1)	2	2000	B30-R4300
i3300, BBP33	Fig. 2	B33-179-7425	B-7425	White	1.000 (25.4)	1.000 (25.4)	1	1500	B30-R4300
i3300, BBP33	Fig. 25	B33-37-7425	B-7425	White	1.500 (38.1)	0.500 (12.7)	2	1500	B30-R4300
i3300, BBP33	Fig. 2	B33-136-7425	B-7425	White	1.500 (38.1)	0.750 (19.1)	1	1500	B30-R4300
i3300, BBP33	Fig. 2	B33-235-7425	B-7425	White	1.500 (38.1)	1.000 (25.4)	1	1250	B30-R4300
i3300, BBP33	Fig. 2	B33-258-7425	B-7425	White	1.500 (38.1)	1.750 (44.5)	1	900	B30-R4300
i3300, BBP33	Fig. 2	B33-53-7425	B-7425	White	2.000 (50.8)	0.500 (12.7)	1	2000	B30-R4300

Retro Reflective Tape (B-584)

- Highly reflective material shines back brightly when struck by light
- Ideal for labeling outdoor utility pedestals, hard hats, jobsite equipment and roof-top equipment
- Recommended for low light or inclement weather conditions

Service temp: -40° F to 158° F
 Application temp: 0° F to 158° F (yellow and orange), 50° F to 158° F (silver)
 Average outdoor durability: 4 to 6 years

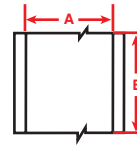

Figure 3



B30 / B33 Series

Fits Printers	Figure	Catalog #	B#	Color	Label Width A Inch (mm)	Roll Length B Feet (m)	Labels Per Roll	Rec. Ribbon
All*	Fig. 3	B30C-1125-584-SL	B-584	Silver	1.125 (28.6)	50 (15.2)	1 roll (cont.)	B30-R10000
All*	Fig. 3	B30C-2250-584-SL	B-584	Silver	2.250 (57.5)	50 (15.2)	1 roll (cont.)	B30-R10000
All* ✕	Fig. 3	B30C-4000-584-SL	B-584	Silver	4.000 (101.6)	50 (15.2)	1 roll (cont.)	B30-R10000
All*	Fig. 3	B30C-1125-584-YL	B-584	Yellow	1.125 (28.6)	50 (15.2)	1 roll (cont.)	B30-R10000
All*	Fig. 3	B30C-2250-584-YL	B-584	Yellow	2.250 (57.5)	50 (15.2)	1 roll (cont.)	B30-R10000
All* ✕	Fig. 3	B30C-4000-584-YL	B-584	Yellow	4.000 (101.6)	50 (15.2)	1 roll (cont.)	B30-R10000
All*	Fig. 3	B30C-1125-584-OR	B-584	Orange	1.125 (28.6)	50 (15.2)	1 roll (cont.)	B30-R10000
All*	Fig. 3	B30C-2250-584-OR	B-584	Orange	2.250 (57.5)	50 (15.2)	1 roll (cont.)	B30-R10000
All* ✕	Fig. 3	B30C-4000-584-OR	B-584	Orange	4.000 (101.6)	50 (15.2)	1 roll (cont.)	B30-R10000

BradyGlo™ High-Intensity Photoluminescent Tape (B-526)

- Designed for directional, evacuation and equipment marking. Ideal for marking emergency utility shut-offs, fire extinguishers, alarm pulls and vital equipment controls
- For glow-in-the-dark identification up to 10 hours
- Complies with indoor use requirements specified in RS 6-1 and 6-1A of New York Local Law 26

Service temp: -40° F to 140° F
 Application temp: 40° F to 140° F

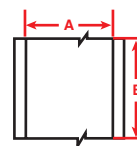

Figure 3



Fits Printers	Figure	Catalog #	B#	Color	Label Width A Inch (mm)	Roll Length B Feet (m)	Labels Per Roll	Rec. Ribbon
All*	Fig. 3	B30C-1125-526	B-526	Luminous Green	1.125 (28.6)	50 (15.2)	1 roll (cont.)	B30-R10000
All*	Fig. 3	B30C-2250-526	B-526	Luminous Green	2.250 (57.5)	50 (15.2)	1 roll (cont.)	B30-R10000
All* ✕	Fig. 3	B30C-4000-526	B-526	Luminous Green	4.000 (101.6)	50 (15.2)	1 roll (cont.)	B30-R10000

✕ Compatible with BBP37 XY cutter.

*All supplies listed are compatible with the following printers unless otherwise noted: BradyPrinter S3000, S3100, i3300, BBP®30, BBP®31, BBP®33, BBP®35 and BBP®37 printers.

Printable Magnetic Supply (B-509)

- Easiest and quickest material for removing and repositioning
- Non-adhesive magnetic material that can be printed on directly
- Ideal for reusable, repositionable and Lean / 5S identification applications

Service temp: 0° F to 158° F
Average outdoor durability: 3 to 5 years

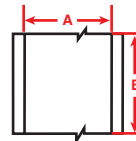

Figure 3



Fits Printers	Figure	Catalog #	B#	Color	Label Width A Inch (mm)	Roll Length B Feet (m)	Labels Per Roll	Rec. Ribbon
All*	Fig. 3	B30C-2500-509-WT	B-509	White	2.500 (63.5)	25 (7.62)	1 roll (cont.)	B30-R10000
All* ✕	Fig. 3	B30C-4250-509-WT	B-509	White	4.250 (107.8)	25 (7.62)	1 roll (cont.)	B30-R10000
All*	Fig. 3	B30C-2500-509-YL	B-509	Yellow	2.500 (63.5)	25 (7.62)	1 roll (cont.)	B30-R10000
All* ✕	Fig. 3	B30C-4250-509-YL	B-509	Yellow	4.250 (107.8)	25 (7.62)	1 roll (cont.)	B30-R10000

Repositionable Vinyl (B-581)

- Aggressive adhesive stays in place but removes cleanly without leaving adhesive residue
- Ideal for temporary, removable and repositionable labels, such as Lean / 5S inventory labels

Service temp: -40° F to 180° F
Application temp: 50° F to 180° F
Average outdoor durability: 5 years

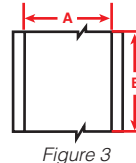

Figure 3



Fits Printers	Figure	Catalog #	B#	Color	Label Width A Inch (mm)	Roll Length B Feet (m)	Labels Per Roll	Rec. Ribbon
All*	Fig. 3	B30C-500-581-WT	B-581	White	0.500 (12.7)	100 (30.5)	1 roll (cont.)	B30-R10000
All*	Fig. 3	B30C-1125-581-WT	B-581	White	1.125 (28.6)	100 (30.5)	1 roll (cont.)	B30-R10000
All*	Fig. 3	B30C-2250-581-WT	B-581	White	2.250 (57.5)	100 (30.5)	1 roll (cont.)	B30-R10000
All* ✕	Fig. 3	B30C-4000-581-WT	B-581	White	4.000 (101.6)	100 (30.5)	1 roll (cont.)	B30-R10000
All*	Fig. 3	B30C-500-581-YL	B-581	Yellow	0.500 (12.7)	100 (30.5)	1 roll (cont.)	B30-R10000
All*	Fig. 3	B30C-1125-581-YL	B-581	Yellow	1.125 (28.6)	100 (30.5)	1 roll (cont.)	B30-R10000
All*	Fig. 3	B30C-2250-581-YL	B-581	Yellow	2.250 (57.5)	100 (30.5)	1 roll (cont.)	B30-R10000
All* ✕	Fig. 3	B30C-4000-581-YL	B-581	Yellow	4.000 (101.6)	100 (30.5)	1 roll (cont.)	B30-R10000

Dissolvable Paper Labels (B-403)

- Designed for temporary applications where easy removal, re-identification or waste reduction are valued
- Ideal for labeling glassware, temporary asset tracking, animal housing identification and general use
- Completely dissolves in warm water within 30 seconds, leaving no adhesive residue

Service temp: -40° F to 172° F

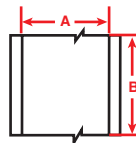

Figure 3



Dissolves within 30 seconds leaving no residue.

Fits Printers	Figure	Catalog #	B#	Color	Label Width A Inch (mm)	Roll Length B Feet (m)	Labels Per Roll	Rec. Ribbon
All*	Fig. 3	B30C-1125-403-WT	B-403	White	1.125 (28.575)	100 (30.5)	1 (cont.)	B30-R4300
All*	Fig. 3	B30C-2250-403-WT	B-403	White	2.250 (57.15)	100 (30.5)	1 (cont.)	B30-R4300
All*	Fig. 3	B30C-3000-403-WT	B-403	White	3.000 (76.2)	100 (30.5)	1 (cont.)	B30-R4300
All*	Fig. 3	B30C-4000-403-WT	B-403	White	4.000 (101.6)	100 (30.5)	1 (cont.)	B30-R4300

✕ Compatible with BBP37 XY cutter.

*All supplies listed are compatible with the following printers unless otherwise noted:
BradyPrinter S3000, S3100, i3300, BBP®30, BBP®31, BBP®33, BBP®35 and BBP®37 printers.

B30- and B33-Series Materials

BradyID.com/s36

General ID Labels for Lean / 5S, Bins and Production Areas (B-483, B-484A, B-498, B-499 and B-595)

- Also ideal for marking backer board, DIN rail, relays, PLCs, switches, solenoids, drive motors and other components inside panels
- All recommended materials are flexible and have high-tack adhesives for adhesion to wide variety of surfaces and components

B-483: Service temp: -40° F to 248° F
 B-484A: Service temp: -40° F to 240° F
 B-498: Service temp: -40° F to 175° F
 B-499: Service temp: -40° F to 193° F
 B-595: Service temp: -40° F to 180° F

Agency approvals:
 Agency approvals:
 Agency approvals:
 Agency approvals:
 Agency approvals:

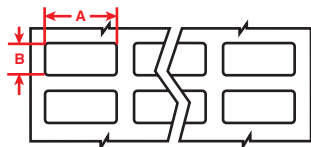

Figure 1

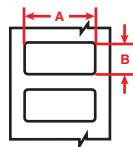

Figure 2

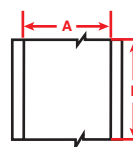

Figure 3



Benchtop Printers

B30 / B33 Series

Fits Printers	Figure	Catalog #	B#	Color	Label Width A Inch (mm)	Label Height B Inch (mm)	Labels Per Row	Labels Per Roll	Rec. Ribbon
Vinyl cloth with ggressive but repositionable adhesive (B-498):									
i3300, BBP33	Fig. 1	B33-90-498	B-498	White	0.250 (6.4)	1.437 (36.5)	6	2500	B30-R6200
i3300, BBP33	Fig. 1	B33-68-498	B-498	White	0.500 (12.7)	0.750 (19.1)	4	5000	B30-R6200
i3300, BBP33	Fig. 1	B33-87-498	B-498	White	0.500 (12.7)	1.437 (36.5)	6	2500	B30-R6200
i3300, BBP33	Fig. 1	B33-1-498	B-498	White	0.750 (19.1)	0.250 (6.4)	4	5000	B30-R6200
i3300, BBP33	Fig. 1	B33-95-498	B-498	White	0.800 (20.3)	1.437 (36.5)	3	2300	B30-R6200
i3300, BBP33	Fig. 1	B33-5-498	B-498	White	1.000 (25.4)	0.500 (12.7)	3	5000	B30-R6200
i3300, BBP33	Fig. 1	B33-88-498	B-498	White	1.000 (25.4)	0.750 (19.1)	2	2500	B30-R6200
i3300, BBP33	Fig. 1	B33-89-498	B-498	White	1.000 (25.4)	1.437 (36.5)	3	2300	B30-R6200
S3000, S3100, i3300, BBP35, BBP37	Fig. 1	B30C-4000-498	B-498	White	4.000 (101.6)	80 ft. (24.4 m)	1 roll (cont.)		B30-R6200
Nylon Cloth with permanent adhesive (B-499):									
i3300, BBP33	Fig. 1	B33-68-499	B-499	White	0.500 (12.7)	0.750 (19.1)	4	1500	B30-R6000
i3300, BBP33	Fig. 1	B33-165-499	B-499	White	0.800 (20.3)	1.437 (36.5)	4	2500	B30-R6000
i3300, BBP33	Fig. 2	B33-125-499	B-499	White	0.900 (22.9)	0.500 (12.7)	1	1500	B30-R6000
i3300, BBP33	Fig. 2	B33-163-499	B-499	White	1.000 (25.4)	0.375 (9.5)	1	1500	B30-R6000
i3300, BBP33	Fig. 1	B33-152-499	B-499	White	1.000 (25.4)	0.375 (9.5)	2	1500	B30-R6000
i3300, BBP33	Fig. 2	B33-136-499	B-499	White	1.500 (38.1)	0.750 (19.1)	1	1500	B30-R6000
i3300, BBP33	Fig. 2	B33-137-499	B-499	White	2.000 (50.8)	1.000 (25.4)	1	1100	B30-R6000
Polyester with ultra-aggressive adhesive for highly textured and low-surface energy surfaces (B-483):									
i3300, BBP33	Fig. 1	B33-149-483	B-483	White	0.500 (12.7)	0.500 (12.7)	4	5000	B30-R6000
i3300, BBP33	Fig. 1	B33-5-483	B-483	White	1.000 (25.4)	0.500 (12.7)	3	5000	B30-R6000
i3300, BBP33	Fig. 2	B33-17-483	B-483	White	2.000 (50.8)	1.000 (25.4)	1	1500	B30-R6000
i3300, BBP33	Fig. 2	B33-7-483	B-483	White	2.750 (69.9)	1.250 (31.8)	1	1000	B30-R6000
i3300, BBP33	Fig. 2	B33-18-483	B-483	White	3.000 (76.2)	1.000 (25.4)	1	1500	B30-R6000
i3300, BBP33	Fig. 2	B33-19-483	B-483	White	3.000 (76.2)	2.000 (50.8)	1	500	B30-R6000
i3300, BBP33	Fig. 2	B33-55-483	B-483	White	4.000 (101.6)	2.000 (50.8)	1	750	B30-R6000
Polyester with ultra-aggressive adhesive and pliable for conforming to angular surfaces (B-484A):									
i3300, BBP33	Fig. 2	B33-125-484	B-484A	White	0.900 (22.9)	0.500 (12.7)	1	1500	B30-R6000
i3300, BBP33	Fig. 1	B33-5-484	B-484A	White	1.000 (25.4)	0.500 (12.7)	3	5000	B30-R6000
i3300, BBP33	Fig. 2	B33-136-484	B-484A	White	1.500 (38.1)	0.750 (19.1)	1	1500	B30-R6000
i3300, BBP33	Fig. 2	B33-17-484	B-484A	White	2.000 (50.8)	1.000 (25.4)	1	1500	B30-R6000
i3300, BBP33	Fig. 2	B33-18-484	B-484A	White	3.000 (76.2)	1.000 (25.4)	1	1500	B30-R6000
i3300, BBP33	Fig. 2	B33-19-484	B-484A	White	3.000 (76.2)	2.000 (50.8)	1	500	B30-R6000
Continuous cut-to-length vinyl with permanent adhesive is conformable and indoor / outdoor grade (B-595):									
All*	Fig. 3	B30C-500-595-WT	B-595**	White	0.500 (12.7)	100 ft. (30.5m)	1 roll (cont.)		B30-R10000
All*	Fig. 3	B30C-1125-595-WT	B-595**	White	1.125 (28.6)	100 ft. (30.5m)	1 roll (cont.)		B30-R10000
All*	Fig. 3	B30C-500-595-YL	B-595**	Yellow	0.500 (12.7)	100 ft. (30.5m)	1 roll (cont.)		B30-R10000
All*	Fig. 3	B30C-1125-595-YL	B-595**	Yellow	1.125 (28.6)	100 ft. (30.5m)	1 roll (cont.)		B30-R10000

** Additional sizes and colors available for B-595 on page 40.

✕ Compatible with BBP37 XY cutter.

*All supplies listed are compatible with the following printers unless otherwise noted: BradyPrinter S3000, S3100, i3300, BBP[®]30, BBP[®]31, BBP[®]33, BBP[®]35 and BBP[®]37 printers.

B30- and B33-Series Materials

BradyID.com/s36

Cold Temperature Application Material (B-549)

- Special adhesive permanently adheres to extremely cold surfaces
- Can be applied in -10° F and lasts in -40° F
- Ideal for cold storage warehouses, coolers, freezers and short-term winter outdoor use

Service temp: -40° F to 212° F
Average outdoor durability: Up to 1 year

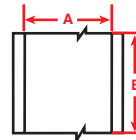

Figure 3



Fits Printers	Figure	Catalog #	B#	Color	Label Width A Inch (mm)	Roll Length B Feet (m)	Labels Per Roll	Rec. Ribbon
All*	Fig. 3	B30C-1125-549-WT	B-549	White	1.125 (28.6)	100 (30.5)	1 roll (cont.)	B30-R10000
All*	Fig. 3	B30C-2250-549-WT	B-549	White	2.250 (57.5)	100 (30.5)	1 roll (cont.)	B30-R10000
All* ✕	Fig. 3	B30C-4000-549-WT	B-549	White	4.000 (101.6)	100 (30.5)	1 roll (cont.)	B30-R10000
All*	Fig. 3	B30C-1125-549-YL	B-549	Yellow	1.125 (28.6)	100 (30.5)	1 roll (cont.)	B30-R10000
All*	Fig. 3	B30C-2250-549-YL	B-549	Yellow	2.250 (57.5)	100 (30.5)	1 roll (cont.)	B30-R10000
All* ✕	Fig. 3	B30C-4000-549-YL	B-549	Yellow	4.000 (101.6)	100 (30.5)	1 roll (cont.)	B30-R10000

ToughStripe® Printable Floor Marking Tape (B-483 with overlaminates)

- Revolutionary B-483 material has ultra-aggressive adhesive
- Each roll ships with a roll of clear overlaminates which must be applied over printed label for best performance

Service temp: -40° F to 248° F
Agency approvals:

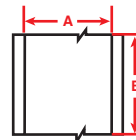

Figure 3



For use with printer*	Figure	Catalog #	B#	Color	Label Width A Inch (mm)	Roll Length B Feet (m)	Labels Per Roll	Rec. Ribbon
S3000, S3100, i3300, BBP35, BBP37	Fig. 3	B30C-1125-483WT-KT	B-483	White	1.125 (28.6)	100 (30.5)	1 roll (cont.)	B30-R6000
S3000, S3100, i3300, BBP35, BBP37	Fig. 3	B30C-2250-483WT-KT	B-483	White	2.250 (57.5)	100 (30.5)	1 roll (cont.)	B30-R6000
S3000, S3100, i3300, BBP35, BBP37	Fig. 3	B30C-3000-483WT-KT	B-483	White	3.000 (76.2)	100 (30.5)	1 roll (cont.)	B30-R6000
S3000, S3100, i3300, BBP35, BBP37 ✕	Fig. 3	B30C-4000-483WT-KT	B-483	White	4.000 (101.6)	100 (30.5)	1 roll (cont.)	B30-R6000
S3000, S3100, i3300, BBP35, BBP37	Fig. 3	B30C-1125-483YL-KT	B-483	Yellow	1.125 (28.6)	100 (30.5)	1 roll (cont.)	B30-R6000
S3000, S3100, i3300, BBP35, BBP37	Fig. 3	B30C-2250-483YL-KT	B-483	Yellow	2.250 (57.5)	100 (30.5)	1 roll (cont.)	B30-R6000
S3000, S3100, i3300, BBP35, BBP37	Fig. 3	B30C-3000-483YL-KT	B-483	Yellow	3.000 (76.2)	100 (30.5)	1 roll (cont.)	B30-R6000
S3000, S3100, i3300, BBP35, BBP37 ✕	Fig. 3	B30C-4000-483YL-KT	B-483	Yellow	4.000 (101.6)	100 (30.5)	1 roll (cont.)	B30-R6000
S3000, S3100, i3300, BBP35, BBP37	Fig. 3	B30C-1125-483RD-KT	B-483	Red	1.125 (28.6)	100 (30.5)	1 roll (cont.)	B30-R4400-WT
S3000, S3100, i3300, BBP35, BBP37	Fig. 3	B30C-2250-483RD-KT	B-483	Red	2.250 (57.5)	100 (30.5)	1 roll (cont.)	B30-R4400-WT
S3000, S3100, i3300, BBP35, BBP37 ✕	Fig. 3	B30C-4000-483RD-KT	B-483	Red	4.000 (101.6)	100 (30.5)	1 roll (cont.)	B30-R4400-WT
S3000, S3100, i3300, BBP35, BBP37	Fig. 3	B30C-1125-483BL-KT	B-483	Blue	1.125 (28.6)	100 (30.5)	1 roll (cont.)	B30-R4400-WT
S3000, S3100, i3300, BBP35, BBP37	Fig. 3	B30C-2250-483BL-KT	B-483	Blue	2.250 (57.5)	100 (30.5)	1 roll (cont.)	B30-R4400-WT
S3000, S3100, i3300, BBP35, BBP37 ✕	Fig. 3	B30C-4000-483BL-KT	B-483	Blue	4.000 (101.6)	100 (30.5)	1 roll (cont.)	B30-R4400-WT
S3000, S3100, i3300, BBP35, BBP37	Fig. 3	B30C-1125-483GN-KT	B-483	Green	1.125 (28.6)	100 (30.5)	1 roll (cont.)	B30-R4400-WT
S3000, S3100, i3300, BBP35, BBP37	Fig. 3	B30C-2250-483GN-KT	B-483	Green	2.250 (57.5)	100 (30.5)	1 roll (cont.)	B30-R4400-WT
S3000, S3100, i3300, BBP35, BBP37 ✕	Fig. 3	B30C-4000-483GN-KT	B-483	Green	4.000 (101.6)	100 (30.5)	1 roll (cont.)	B30-R4400-WT
S3000, S3100, i3300, BBP35, BBP37	Fig. 3	B30C-1125-483BK-KT	B-483	Black	1.125 (28.6)	100 (30.5)	1 roll (cont.)	B30-R4400-WT
S3000, S3100, i3300, BBP35, BBP37	Fig. 3	B30C-2250-483BK-KT	B-483	Black	2.250 (57.5)	100 (30.5)	1 roll (cont.)	B30-R4400-WT
S3000, S3100, i3300, BBP35, BBP37 ✕	Fig. 3	B30C-4000-483BK-KT	B-483	Black	4.000 (101.6)	100 (30.5)	1 roll (cont.)	B30-R4400-WT
S3000, S3100, i3300, BBP35, BBP37	Fig. 3	B30C-1125-483OR-KT	B-483	Orange	1.125 (28.6)	100 (30.5)	1 roll (cont.)	B30-R6000
S3000, S3100, i3300, BBP35, BBP37	Fig. 3	B30C-2250-483OR-KT	B-483	Orange	2.250 (57.5)	100 (30.5)	1 roll (cont.)	B30-R6000
S3000, S3100, i3300, BBP35, BBP37 ✕	Fig. 3	B30C-4000-483OR-KT	B-483	Orange	4.000 (101.6)	100 (30.5)	1 roll (cont.)	B30-R6000

ToughStripe material is not compatible with BBP®30, BBP®33 and BBP®31 printers.

ToughStripe material also available as:

- Solid, striped and dashed tape
- Die-cut shape, numbers and letters

View page 295 for more additional products.

✕ Compatible with BBP37 XY cutter.

*All supplies listed are compatible with the following printers unless otherwise noted: BradyPrinter S3000, S3100, i3300, BBP®30, BBP®31, BBP®33, BBP®35 and BBP®37 printers.

B30- and B33-Series Materials

BradyID.com/s36

Raised Profile - Engraved Plate Substitute Labels (B-593) Push Button Style

- High gloss, polyester label with thick raised profile and ultra-aggressive adhesive (0.70 mm thick)
- High-performance, low-cost substitute to engraved plates – costs up to 80% less
- 10-year outdoor durability rating
- On-demand labeling: prints out in fewer than 4 seconds
- 5 push button sizes (including keyed and non-keyed 22.5 mm and 30.5 mm hole diameters)

Service temp: -4° F to 212° F
Application temp: 50° F to 212° F
Agency approvals:

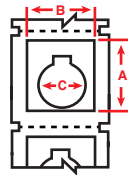

Figure 18a

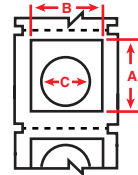
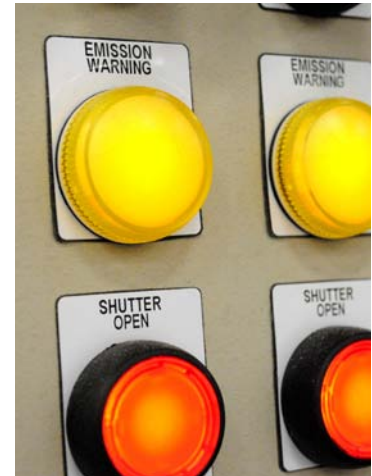

Figure 18b
(without key hole)



Benchmark Printers

B30 / B33 Series

Fits Printers	Figure	Catalog #	B#	Color	Label Height A Inch (mm)	Label Width B Inch (mm)	Hole Diameter C Inch (mm)	Labels Per Row	Labels Per Roll	Rec. Ribbon
All*	Fig. 18a	B30EP-167-593-WT	B-593	White	1.500 (38.1)	1.200 (30.5)	0.885 (22.5)	1	200	B30-R6000
All*	Fig. 18b	B30EP-167U-593-WT	B-593	White	1.500 (38.1)	1.200 (30.5)	0.885 (22.5)	1	200	B30-R6000
All*	Fig. 18a	B30EP-169-593-WT	B-593	White	1.800 (45.7)	1.800 (45.7)	1.200 (30.5)	1	190	B30-R6000
All*	Fig. 18a	B30EP-168-593-WT	B-593	White	1.900 (48.3)	1.200 (30.5)	0.885 (22.5)	1	180	B30-R6000
All*	Fig. 18a	B30EP-170-593-WT	B-593	White	2.400 (60.9)	2.400 (60.9)	1.200 (30.5)	1	145	B30-R6000
All*	Fig. 18a	B30EP-167-593-YL	B-593	Yellow	1.500 (38.1)	1.200 (30.5)	0.885 (22.5)	1	200	B30-R6000
All*	Fig. 18b	B30EP-167U-593-YL	B-593	Yellow	1.500 (38.1)	1.200 (30.5)	0.885 (22.5)	1	200	B30-R6000
All*	Fig. 18a	B30EP-169-593-YL	B-593	Yellow	1.800 (45.7)	1.800 (45.7)	1.200 (30.5)	1	190	B30-R6000
All*	Fig. 18a	B30EP-168-593-YL	B-593	Yellow	1.900 (48.3)	1.200 (30.5)	0.885 (22.5)	1	180	B30-R6000
All*	Fig. 18a	B30EP-170-593-YL	B-593	Yellow	2.400 (60.9)	2.400 (60.9)	1.200 (30.5)	1	145	B30-R6000
All*	Fig. 18a	B30EP-167-593-BK	B-593	Black	1.500 (38.1)	1.200 (30.5)	0.885 (22.5)	1	200	B30-R4400-WT
All*	Fig. 18b	B30EP-167U-593-BK	B-593	Black	1.500 (38.1)	1.200 (30.5)	0.885 (22.5)	1	200	B30-R4400-WT
All*	Fig. 18a	B30EP-169-593-BK	B-593	Black	1.800 (45.7)	1.800 (45.7)	1.200 (30.5)	1	190	B30-R4400-WT
All*	Fig. 18a	B30EP-168-593-BK	B-593	Black	1.900 (48.3)	1.200 (30.5)	0.885 (22.5)	1	180	B30-R4400-WT
All*	Fig. 18a	B30EP-170-593-BK	B-593	Black	2.400 (60.9)	2.400 (60.9)	1.200 (30.5)	1	145	B30-R4400-WT
All*	Fig. 18a	B30EP-167-593-GN	B-593	Green	1.500 (38.1)	1.200 (30.5)	0.885 (22.5)	1	200	B30-R4400-WT
All*	Fig. 18b	B30EP-167U-593-GN	B-593	Green	1.500 (38.1)	1.200 (30.5)	0.885 (22.5)	1	200	B30-R4400-WT
All*	Fig. 18a	B30EP-169-593-GN	B-593	Green	1.800 (45.7)	1.800 (45.7)	1.200 (30.5)	1	190	B30-R4400-WT
All*	Fig. 18a	B30EP-168-593-GN	B-593	Green	1.900 (48.3)	1.200 (30.5)	0.885 (22.5)	1	180	B30-R4400-WT
All*	Fig. 18a	B30EP-170-593-GN	B-593	Green	2.400 (60.9)	2.400 (60.9)	1.200 (30.5)	1	145	B30-R4400-WT
All*	Fig. 18a	B30EP-167-593-RD	B-593	Red	1.500 (38.1)	1.200 (30.5)	0.885 (22.5)	1	200	B30-R4400-WT
All*	Fig. 18b	B30EP-167U-593-RD	B-593	Red	1.500 (38.1)	1.200 (30.5)	0.885 (22.5)	1	200	B30-R4400-WT
All*	Fig. 18a	B30EP-169-593-RD	B-593	Red	1.800 (45.7)	1.800 (45.7)	1.200 (30.5)	1	190	B30-R4400-WT
All*	Fig. 18a	B30EP-168-593-RD	B-593	Red	1.900 (48.3)	1.200 (30.5)	0.885 (22.5)	1	180	B30-R4400-WT
All*	Fig. 18a	B30EP-170-593-RD	B-593	Red	2.400 (60.9)	2.400 (60.9)	1.200 (30.5)	1	145	B30-R4400-WT

U.S. Patent No. US8475914B2; US9005729B2.

*All supplies listed are compatible with the following printers unless otherwise noted: BradyPrinter S3000, S3100, i3300, BBP®30, BBP®31, BBP®33, BBP®35 and BBP®37 printers.

Raised Profile - Engraved Plate Substitute Labels (B-593) Rectangular Style

- High gloss, polyester label with thick raised profile and ultra-aggressive adhesive (0.70 mm thick)
- High-performance, low-cost substitute to engraved plates – costs up to 80% less
- 10-year outdoor durability rating
- On-demand labeling: prints out in fewer than 4 seconds
- Ideal for inside-panel backer board labels and front-of-enclosure labeling

Service temp: -4° F to 212° F
Application temp: 50° F to 212° F
Agency approvals:

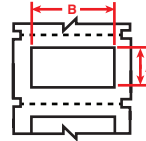
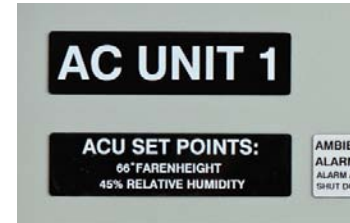

Figure 18c



Fits Printers	Figure	Catalog #	B#	Color	Label Height A Inch (mm)	Label Width B Inch (mm)	Labels Per Row	Labels Per Roll	Rec. Ribbon
All*	Fig. 18c	B30EP-171-593-WT	B-593	White	0.490 (12.5)	1.060 (26.9)	1	500	B30-R6000
All*	Fig. 18c	B30EP-172-593-WT	B-593	White	0.590 (15.0)	1.770 (45.0)	1	450	B30-R6000
All*	Fig. 18c	B30EP-175-593-WT	B-593	White	0.750 (19.1)	3.000 (76.2)	1	375	B30-R6000
All*	Fig. 18c	B30EP-173-593-WT	B-593	White	1.000 (25.4)	2.000 (50.8)	1	300	B30-R6000
All*	Fig. 18c	B30EP-174-593-WT	B-593	White	1.000 (25.4)	4.000 (101.6)	1	300	B30-R6000
All*	Fig. 18c	B30EP-176-593-WT	B-593	White	1.000 (25.4)	3.000 (76.2)	1	300	B30-R6000
All*	Fig. 18c	B30EP-177-593-WT	B-593	White	2.500 (63.5)	3.000 (76.2)	1	125	B30-R6000
All*	Fig. 18c	B30EP-171-593-YL	B-593	Yellow	0.490 (12.5)	1.060 (26.9)	1	500	B30-R6000
All*	Fig. 18c	B30EP-172-593-YL	B-593	Yellow	0.590 (15.0)	1.770 (45.0)	1	450	B30-R6000
All*	Fig. 18c	B30EP-175-593-YL	B-593	Yellow	0.750 (19.1)	3.000 (76.2)	1	375	B30-R6000
All*	Fig. 18c	B30EP-173-593-YL	B-593	Yellow	1.000 (25.4)	2.000 (50.8)	1	300	B30-R6000
All*	Fig. 18c	B30EP-174-593-YL	B-593	Yellow	1.000 (25.4)	4.000 (101.6)	1	300	B30-R6000
All*	Fig. 18c	B30EP-176-593-YL	B-593	Yellow	1.000 (25.4)	3.000 (76.2)	1	300	B30-R6000
All*	Fig. 18c	B30EP-177-593-YL	B-593	Yellow	2.500 (63.5)	3.000 (76.2)	1	125	B30-R6000
All*	Fig. 18c	B30EP-171-593-BK	B-593	Black	0.490 (12.5)	1.060 (26.9)	1	500	B30-R4400-WT
All*	Fig. 18c	B30EP-172-593-BK	B-593	Black	0.590 (15.0)	1.770 (45.0)	1	450	B30-R4400-WT
All*	Fig. 18c	B30EP-175-593-BK	B-593	Black	0.750 (19.1)	3.000 (76.2)	1	375	B30-R4400-WT
All*	Fig. 18c	B30EP-173-593-BK	B-593	Black	1.000 (25.4)	2.000 (50.8)	1	300	B30-R4400-WT
All*	Fig. 18c	B30EP-174-593-BK	B-593	Black	1.000 (25.4)	4.000 (101.6)	1	300	B30-R4400-WT
All*	Fig. 18c	B30EP-176-593-BK	B-593	Black	1.000 (25.4)	3.000 (76.2)	1	300	B30-R4400-WT
All*	Fig. 18c	B30EP-177-593-BK	B-593	Black	2.500 (63.5)	3.000 (76.2)	1	125	B30-R4400-WT
All*	Fig. 18c	B30EP-171-593-GN	B-593	Green	0.490 (12.5)	1.060 (26.9)	1	500	B30-R4400-WT
All*	Fig. 18c	B30EP-172-593-GN	B-593	Green	0.590 (15.0)	1.770 (45.0)	1	450	B30-R4400-WT
All*	Fig. 18c	B30EP-175-593-GN	B-593	Green	0.750 (19.1)	3.000 (76.2)	1	375	B30-R4400-WT
All*	Fig. 18c	B30EP-173-593-GN	B-593	Green	1.000 (25.4)	2.000 (50.8)	1	300	B30-R4400-WT
All*	Fig. 18c	B30EP-174-593-GN	B-593	Green	1.000 (25.4)	4.000 (101.6)	1	300	B30-R4400-WT
All*	Fig. 18c	B30EP-176-593-GN	B-593	Green	1.000 (25.4)	3.000 (76.2)	1	300	B30-R4400-WT
All*	Fig. 18c	B30EP-177-593-GN	B-593	Green	2.500 (63.5)	3.000 (76.2)	1	125	B30-R4400-WT
All*	Fig. 18c	B30EP-171-593-RD	B-593	Red	0.490 (12.5)	1.060 (26.9)	1	500	B30-R4400-WT
All*	Fig. 18c	B30EP-172-593-RD	B-593	Red	0.590 (15.0)	1.770 (45.0)	1	450	B30-R4400-WT
All*	Fig. 18c	B30EP-173-593-RD	B-593	Red	1.000 (25.4)	2.000 (50.8)	1	300	B30-R4400-WT
All*	Fig. 18c	B30EP-174-593-RD	B-593	Red	1.000 (25.4)	4.000 (101.6)	1	300	B30-R4400-WT
All*	Fig. 18c	B30EP-171-593-SL	B-593	Silver	0.490 (12.5)	1.060 (26.9)	1	500	B30-R6000
All*	Fig. 18c	B30EP-172-593-SL	B-593	Silver	0.590 (15.0)	1.770 (45.0)	1	450	B30-R6000
All*	Fig. 18c	B30EP-173-593-SL	B-593	Silver	1.000 (25.4)	2.000 (50.8)	1	300	B30-R6000
All*	Fig. 18c	B30EP-174-593-SL	B-593	Silver	1.000 (25.4)	4.000 (101.6)	1	300	B30-R6000

U.S. Patent No. US8475914B2; US9005729B2.

*All supplies listed are compatible with the following printers unless otherwise noted:
BradyPrinter S3000, S3100, i3300, BBP®30, BBP®31, BBP®33, BBP®35 and BBP®37 printers.

B30- and B33-Series Materials

BradyID.com/s36

Polyester Labels

(B-422, B-423, B-430, B-432, B-483, B-484A and B-489)

- For product, circuit board and component ID as well as for general purpose industrial identification
- Ideal for textured and curved surfaces

B-423: Service temp: -94° F to 248° F Agency approvals:
 B-430: Service temp: -40° F to 212° F Agency approvals:
 B-432: Service temp: -40° F to 212° F Agency approvals:
 B-483: Service temp: -94° F to 248° F Agency approvals:
 B-484A: Service temp: -40° F to 240° F Agency approvals:
 B-489: Service temp: -94° F to 248° F Agency approvals:



Benchmark Printers

B30 / B33 Series

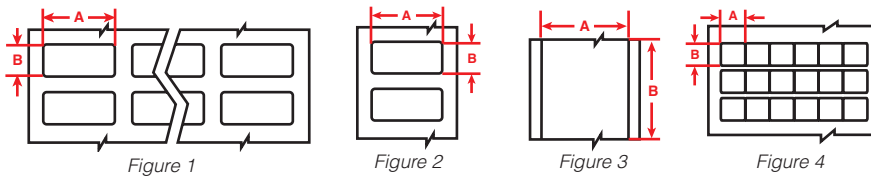

Fits Printers	Figure	Catalog #	B#	Color	Label Width A Inch (mm)	Label Height B Inch (mm)	Labels Per Row	Labels Per Roll	Rec. Ribbon
Standard adhesive (B-423 gloss white):									
i3300, BBP33	Fig. 4	B33-11-423	B-423	Gloss White	0.250 (6.4)	0.250 (6.4)	12	15000	B30-R6000
i3300, BBP33	Fig. 1	B33-38-423	B-423	Gloss White	0.375 (9.5)	0.375 (9.5)	9	5000	B30-R6000
i3300, BBP33	Fig. 1	B33-149-423	B-423	Gloss White	0.500 (12.7)	0.500 (12.7)	4	5000	B30-R6000
i3300, BBP33	Fig. 1	B33-1-423	B-423	Gloss White	0.750 (19.1)	0.250 (6.4)	4	5000	B30-R6000
i3300, BBP33	Fig. 2	B33-46-423	B-423	Gloss White	0.750 (19.1)	0.250 (6.4)	1	5000	B30-R6000
i3300, BBP33	Fig. 2	B33-49-423	B-423	Gloss White	0.900 (22.9)	0.250 (6.4)	1	5000	B30-R6000
i3300, BBP33	Fig. 2	B33-103-423	B-423	Gloss White	1.000 (25.4)	0.250 (6.4)	1	5000	B30-R6000
i3300, BBP33	Fig. 1	B33-3-423	B-423	Gloss White	1.000 (25.4)	0.375 (9.5)	3	5000	B30-R6000
i3300, BBP33	Fig. 1	B33-5-423	B-423	Gloss White	1.000 (25.4)	0.500 (12.7)	3	5000	B30-R6000
i3300, BBP33	Fig. 2	B33-43-423	B-423	Gloss White	1.250 (31.8)	0.250 (6.4)	1	5000	B30-R6000
i3300, BBP33	Fig. 1	B33-29-423	B-423	Gloss White	1.250 (31.8)	0.375 (9.5)	2	5000	B30-R6000
i3300, BBP33	Fig. 2	B33-45-423	B-423	Gloss White	1.500 (38.1)	0.250 (6.4)	1	5000	B30-R6000
i3300, BBP33	Fig. 2	B33-72-423	B-423	Gloss White	1.750 (44.5)	0.250 (6.4)	1	5000	B30-R6000
i3300, BBP33	Fig. 2	B33-53-423	B-423	Gloss White	2.000 (50.8)	0.500 (12.7)	1	2500	B30-R6000
i3300, BBP33	Fig. 2	B33-17-423	B-423	Gloss White	2.000 (50.8)	1.000 (25.4)	1	1500	B30-R6000
i3300, BBP33	Fig. 2	B33-18-423	B-423	Gloss White	3.000 (76.2)	1.000 (25.4)	1	1500	B30-R6000
i3300, BBP33	Fig. 2	B33-19-423	B-423	Gloss White	3.000 (76.2)	2.000 (50.8)	1	500	B30-R6000
i3300, BBP33	Fig. 2	B33-55-423	B-423	Gloss White	4.000 (101.6)	2.000 (50.8)	1	750	B30-R6000
S3000, S3100, i3300, BBP35, BBP37 ✕	Fig. 3	B30C-4000-423	B-423	Gloss White	4.000 (101.6)	150 ft. (45.7 m)	1 roll (cont.)		B30-R6000
Standard adhesive (B-430 clear):									
i3300, BBP33	Fig. 1	B33-5-430	B-430	Clear	1.000 (25.4)	0.500 (12.7)	3	5000	B30-R6000
i3300, BBP33	Fig. 2	B33-17-430	B-430	Clear	2.000 (50.8)	1.000 (25.4)	1	1500	B30-R6000
i3300, BBP33	Fig. 2	B33-18-430	B-430	Clear	3.000 (76.2)	1.000 (25.4)	1	1500	B30-R6000
Strong adhesive for textured surfaces (B-422 gloss white):									
i3300, BBP33	Fig. 1	B33-149-422	B-422	Gloss White	0.500 (12.7)	0.500 (12.7)	4	5000	B30-R6000
i3300, BBP33	Fig. 1	B33-5-422	B-422	Gloss White	1.000 (25.4)	0.500 (12.7)	3	5000	B30-R6000
i3300, BBP33	Fig. 1	B33-147-422	B-422	Gloss White	1.500 (38.1)	0.375 (9.5)	2	2500	B30-R6000
i3300, BBP33	Fig. 2	B33-102-422	B-422	Gloss White	1.500 (38.1)	0.375 (9.5)	1	2500	B30-R6000
i3300, BBP33	Fig. 2	B33-136-422	B-422	Gloss White	1.500 (38.1)	0.750 (19.1)	1	1500	B30-R6000
i3300, BBP33	Fig. 2	B33-17-422	B-422	Gloss White	2.000 (50.8)	1.000 (25.4)	1	1500	B30-R6000
i3300, BBP33	Fig. 2	B33-18-422	B-422	Gloss White	3.000 (76.2)	1.000 (25.4)	1	1500	B30-R6000
i3300, BBP33	Fig. 2	B33-19-422	B-422	Gloss White	3.000 (76.2)	2.000 (50.8)	1	500	B30-R6000
i3300, BBP33	Fig. 2	B33-76-422	B-422	Gloss White	4.000 (101.6)	3.000 (76.2)	1	500	B30-R6000

✕ Compatible with BBP37 XY cutter.

*All supplies listed are compatible with the following printers unless otherwise noted: BradyPrinter S3000, S3100, i3300, BBP[®]30, BBP[®]31, BBP[®]33, BBP[®]35 and BBP[®]37 printers.

B30- and B33-Series Materials

BradyID.com/s36

Polyester Labels (continued)

Fits Printers	Figure	Catalog #	B#	Color	Label Width A Inch (mm)	Label Height B Inch (mm)	Labels Per Row	Labels Per Roll	Rec. Ribbon
Stronger adhesive for textured surfaces (B-432 clear):									
i3300, BBP33	Fig. 1	B33-149-432	B-432	Clear	0.500 (12.7)	0.500 (12.7)	4	5000	B30-R6000
i3300, BBP33	Fig. 1	B33-5-432	B-432	Clear	1.000 (25.4)	0.500 (12.7)	3	5000	B30-R6000
i3300, BBP33	Fig. 2	B33-17-432	B-432	Clear	2.000 (50.8)	1.000 (25.4)	1	1500	B30-R6000
i3300, BBP33	Fig. 2	B33-18-432	B-432	Clear	3.000 (76.2)	1.000 (25.4)	1	1500	B30-R6000
i3300, BBP33	Fig. 2	B33-19-432	B-432	Clear	3.000 (76.2)	2.000 (50.8)	1	500	B30-R6000
S3000, S3100, i3300, BBP35, BBP37	✂ Fig. 3	B30C-4000-432	B-432	Clear	4.000 (101.6)	120 ft. (36.6 m)	1 roll (cont.)		B30-R6000
Ultra-aggressive adhesive for highly textured surfaces (B-483 gloss white):									
i3300, BBP33	Fig. 1	B33-149-483	B-483	Gloss White	0.500 (12.7)	0.500 (12.7)	4	5000	B30-R6000
i3300, BBP33	Fig. 1	B33-5-483	B-483	Gloss White	1.000 (25.4)	0.500 (12.7)	3	5000	B30-R6000
i3300, BBP33	Fig. 2	B33-17-483	B-483	Gloss White	2.000 (50.8)	1.000 (25.4)	1	1500	B30-R6000
i3300, BBP33	Fig. 2	B33-7-483	B-483	Gloss White	2.750 (69.9)	1.250 (31.8)	1	1000	B30-R6000
i3300, BBP33	Fig. 2	B33-18-483	B-483	Gloss White	3.000 (76.2)	1.000 (25.4)	1	1500	B30-R6000
i3300, BBP33	Fig. 2	B33-19-483	B-483	Gloss White	3.000 (76.2)	2.000 (50.8)	1	500	B30-R6000
i3300, BBP33	Fig. 2	B33-55-483	B-483	Gloss White	4.000 (101.6)	2.000 (50.8)	1	750	B30-R6000
S3000, S3100, i3300, BBP35, BBP37	✂ Fig. 3	B30C-4000-483	B-483	Gloss White	4.000 (101.6)	130 ft. (39.6 m)	1 roll (cont.)		B30-R6000
Ultra-aggressive adhesive for highly textured surfaces (B-489 matte white):									
i3300, BBP33	Fig. 1	B33-5-489	B-489	Matte White	1.000 (25.4)	0.500 (12.7)	3	5000	B30-R4300
i3300, BBP33	Fig. 2	B33-17-489	B-489	Matte White	2.000 (50.8)	1.000 (25.4)	1	1500	B30-R4300
i3300, BBP33	Fig. 2	B33-18-489	B-489	Matte White	3.000 (76.2)	1.000 (25.4)	1	1500	B30-R4300
i3300, BBP33	Fig. 2	B33-19-489	B-489	Matte White	3.000 (76.2)	2.000 (50.8)	1	500	B30-R4300
S3000, S3100, i3300, BBP35, BBP37	✂ Fig. 3	B30C-4000-489	B-489	Matte White	4.000 (101.6)	130 ft. (39.6 m)	1 roll (cont.)		B30-R4300
Ultra-aggressive adhesive and pliable for conforming to angular surfaces (B-484A gloss white):									
i3300, BBP33	Fig. 2	B33-125-484	B-484A	Gloss White	0.900 (22.9)	0.500 (12.7)	1	1500	B30-R6000
i3300, BBP33	Fig. 1	B33-5-484	B-484A	Gloss White	1.000 (25.4)	0.500 (12.7)	3	5000	B30-R6000
i3300, BBP33	Fig. 2	B33-136-484	B-484A	Gloss White	1.500 (38.1)	0.750 (19.1)	1	1500	B30-R6000
i3300, BBP33	Fig. 2	B33-17-484	B-484A	Gloss White	2.000 (50.8)	1.000 (25.4)	1	1500	B30-R6000
i3300, BBP33	Fig. 2	B33-18-484	B-484A	Gloss White	3.000 (76.2)	1.000 (25.4)	1	1500	B30-R6000
i3300, BBP33	Fig. 2	B33-19-484	B-484A	Gloss White	3.000 (76.2)	2.000 (50.8)	1	500	B30-R6000
S3000, S3100, i3300, BBP35, BBP37	✂ Fig. 3	B30C-4000-484	B-484A	Gloss White	4.000 (101.6)	150 ft. (45.7 m)	1 roll (cont.)		B30-R6000
Permanent acrylic adhesive (B-488 matte white)									
S3000, S3100, i3300, BBP35, BBP37	✂ Fig. 3	B30C-4000-488	B-488	Matte White	4.000 (101.6)	130 ft. (39.6 m)	1 roll (cont.)		B30-R4300
Self-extinguishing polyvinylfluoride (B-787 gloss white)									
S3000, S3100, i3300, BBP35, BBP37	✂ Fig. 3	B30C-4000-787	B-787	Gloss White	4.000 (101.6)	60 ft. (18.3 m)	1 roll (cont.)		B30-R6000

Technical Data Sheets
 Technical Data Sheets for all Brady label materials are available at:
BradyID.com/techdata

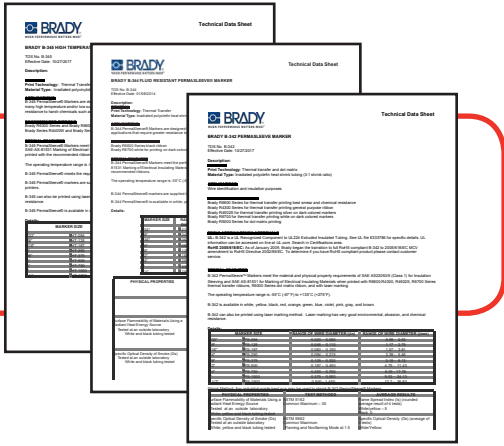

✂ Compatible with BBP37 XY cutter.

*All supplies listed are compatible with the following printers unless otherwise noted:
 BradyPrinter S3000, S3100, i3300, BBP[®]30, BBP[®]31, BBP[®]33, BBP[®]35 and BBP[®]37 printers.



B30- and B33-Series Materials

BradyID.com/s36

Metallized Polyester Labels (B-428, B-434, B-435, B-438, B-486 and B-565)

- For product labeling, asset tracking and general industrial identification
- Ideal for serial number plates and rating plates with name-plate quality and metal-looking finish

B-428: Service temp: -40° F to 293° F Agency approvals:
 B-434: Service temp: -40° F to 194° F Agency approvals:
 B-435: Service temp: -40° F to 194° F Agency approvals:
 B-438: Service temp: -40° F to 104° F Agency approvals:
 B-480: Service temp: -94° F to 248° F Agency approvals:
 B-486: Service temp: -40° F to 248° F Agency approvals:
 B-565: Service temp: -40° F to 240° F Agency approvals:

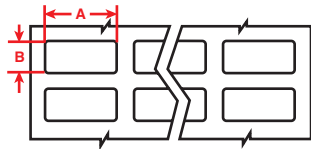

Figure 1

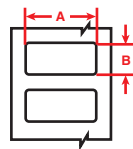

Figure 2

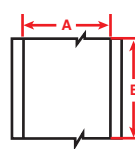

Figure 3

Benchtop Printers

B30 / B33 Series

Fits Printers	Figure	Catalog #	B#	Color	Label Width A Inch (mm)	Label Height B Inch (mm)	Labels Per Row	Labels Per Roll	Rec. Ribbon
Standard adhesive for smooth surfaces (B-428 matte):									
i3300, BBP33	Fig. 1	B33-5-428	B-428	Matte Silver	1.000 (25.4)	0.500 (12.7)	3	5000	B30-R4300
i3300, BBP33	Fig. 2	B33-53-428	B-428	Matte Silver	2.000 (50.8)	0.500 (12.7)	1	2500	B30-R4300
i3300, BBP33	Fig. 2	B33-17-428	B-428	Matte Silver	2.000 (50.8)	1.000 (25.4)	1	1500	B30-R4300
i3300, BBP33	Fig. 2	B33-18-428	B-428	Matte Silver	3.000 (76.2)	1.000 (25.4)	1	1500	B30-R4300
i3300, BBP33	Fig. 2	B33-19-428	B-428	Matte Silver	3.000 (76.2)	2.000 (50.8)	1	500	B30-R4300
i3300, BBP33	Fig. 3	B33C-3000-428	B-428	Matte Silver	3.000 (76.2)	85 ft. (25.9m)	1 roll (cont.)		B30-R4300
S3000, S3100, i3300, BBP35, BBP37	Fig. 3	B30C-4000-428	B-428	Matte Silver	4.000 (101.6)	130 ft. (39.6 m)	1 roll (cont.)		B30-R4300
Standard adhesive for smooth surfaces (B-565 matte):									
All*	Fig. 3	B30C-1125-565-SL	B-565	Matte Silver	1.125 (28.6)	100 ft. (30.5m)	1 roll (cont.)		B30-R4300
All*	Fig. 3	B30C-2250-565-SL	B-565	Matte Silver	2.250 (57.5)	100 ft. (30.5m)	1 roll (cont.)		B30-R4300
All*	Fig. 3	B30C-4000-565-SL	B-565	Matte Silver	4.000 (101.6)	100 ft. (30.5m)	1 roll (cont.)		B30-R4300
Standard adhesive for smooth surfaces (B-435 gloss):									
i3300, BBP33	Fig. 2	B33-18-435	B-435	Gloss Silver	3.000 (76.2)	1.000 (25.4)	1	1500	B30-R6000
i3300, BBP33	Fig. 2	B33-19-435	B-435	Gloss Silver	3.000 (76.2)	2.000 (50.8)	1	500	B30-R6000
i3300, BBP33	Fig. 2	B33-55-435	B-435	Gloss Silver	4.000 (101.6)	2.000 (50.8)	1	750	B30-R6000
Stronger adhesive for rougher surfaces (B-434 gloss):									
i3300, BBP33	Fig. 1	B33-5-434	B-434	Gloss Silver	1.000 (25.4)	0.500 (12.7)	3	5000	B30-R6000
i3300, BBP33	Fig. 2	B33-136-434	B-434	Gloss Silver	1.500 (38.1)	0.750 (19.1)	1	1500	B30-R6000
i3300, BBP33	Fig. 2	B33-17-434	B-434	Gloss Silver	2.000 (50.8)	1.000 (25.4)	1	1500	B30-R6000
i3300, BBP33	Fig. 2	B33-18-434	B-434	Gloss Silver	3.000 (76.2)	1.000 (25.4)	1	1500	B30-R6000
i3300, BBP33	Fig. 2	B33-19-434	B-434	Gloss Silver	3.000 (76.2)	2.000 (50.8)	1	500	B30-R6000
i3300, BBP33	Fig. 2	B33-55-434	B-434	Gloss Silver	4.000 (101.6)	2.000 (50.8)	1	750	B30-R6000
S3000, S3100, i3300, BBP35, BBP37	Fig. 3	B30C-4000-434	B-434	Gloss Silver	4.000 (101.6)	130 ft. (39.6 m)	1 roll (cont.)		B30-R6000
Ultra-aggressive adhesive with metallic looking finish (B-480 satin):									
S3000, S3100, i3300, BBP35, BBP37	Fig. 3	B30C-4000-480	B-480	Light Gray	4.000 (101.6)	115 ft. (35.1 m)	1 roll (cont.)		B30-R6000
Ultra-aggressive adhesive for highly textured, powder coated and low surface energy surfaces (B-486 matte):									
i3300, BBP33	Fig. 2	B33-59-486	B-486	Matte Silver	1.000 (25.4)	0.500 (12.7)	1	2500	B30-R4300
i3300, BBP33	Fig. 1	B33-5-486	B-486	Matte Silver	1.000 (25.4)	0.500 (12.7)	3	5000	B30-R4300
i3300, BBP33	Fig. 2	B33-53-486	B-486	Matte Silver	2.000 (50.8)	0.500 (12.7)	1	2500	B30-R4300
i3300, BBP33	Fig. 2	B33-17-486	B-486	Matte Silver	2.000 (50.8)	1.000 (25.4)	1	1300	B30-R4300
i3300, BBP33	Fig. 2	B33-7-486	B-486	Matte Silver	2.750 (69.9)	1.250 (31.8)	1	1000	B30-R4300
i3300, BBP33	Fig. 2	B33-18-486	B-486	Matte Silver	3.000 (76.2)	1.000 (25.4)	1	1300	B30-R4300
i3300, BBP33	Fig. 2	B33-19-486	B-486	Matte Silver	3.000 (76.2)	2.000 (50.8)	1	500	B30-R4300
i3300, BBP33	Fig. 2	B33-76-486	B-486	Matte Silver	4.000 (101.6)	3.000 (76.2)	1	500	B30-R4300
i3300, BBP33	Fig. 2	B33-161-486	B-486	Matte Silver	4.000 (101.6)	4.000 (101.6)	1	250	B30-R4300
S3000, S3100, i3300, BBP35, BBP37	Fig. 2	B30C-4000-486	B-486	Matte Silver	4.000 (101.6)	115 ft. (35.1 m)	1 roll (cont.)		B30-R4300

✗ Compatible with BBP37 XY cutter.

*All supplies listed are compatible with the following printers unless otherwise noted: BradyPrinter S3000, S3100, i3300, BBP[®]30, BBP[®]31, BBP[®]33, BBP[®]35 and BBP[®]37 printers.

Tamper-Evident Asset ID Labels (B-438)

Leaves checkerboard footprint on surface and on label if removed to prevent re-use

Service temp: -40° F to 104° F
Agency approvals:

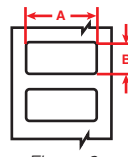

Figure 2

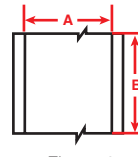

Figure 3



Fits Printers	Figure	Catalog #	B#	Color	Label Width A Inch (mm)	Label Height B Inch (mm)	Labels Per Row	Labels Per Roll	Rec. Ribbon
All*	Fig. 2	B30-17-438	B-438	Matte Silver	2.000 (50.8)	1.000 (25.4)	1	1225	B30-R4300
All*	Fig. 2	B30-18-438	B-438	Matte Silver	3.000 (76.2)	1.000 (25.4)	1	1225	B30-R4300
All*	Fig. 2	B30-222-438	B-438	Matte Silver	3.000 (76.2)	2.000 (50.8)	1	650	B30-R4300
All*	Fig. 3	B30C-3000-438-SL	B-438	Matte Silver	3.000 (76.2)	100 ft. (30.5 m)	1 roll (cont.)		B30-R4300

Paper Labels (B-424)

- Economical choice for light duty general ID
- White finish and matte topcoat
- Excellent contrast and smear resistance for barcode printing

Service temp: -40° F to 124° F
Agency approvals:

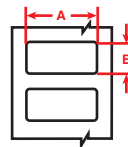

Figure 2



Fits Printers	Figure	Catalog #	B#	Color	Label Width A Inch (mm)	Label Height B Inch (mm)	Labels Per Row	Labels Per Roll	Rec. Ribbon
i3300, BBP33	Fig. 2	B33-53-424	B-424	White	2.000 (50.8)	0.500 (12.7)	1	2500	B30-R4300
i3300, BBP33	Fig. 2	B33-17-424	B-424	White	2.000 (50.8)	1.000 (25.4)	1	1500	B30-R4300
i3300, BBP33	Fig. 2	B33-7-424	B-424	White	2.750 (69.9)	1.250 (31.8)	1	1000	B30-R4300
i3300, BBP33	Fig. 2	B33-18-424	B-424	White	3.000 (76.2)	1.000 (25.4)	1	1500	B30-R4300
i3300, BBP33	Fig. 2	B33-19-424	B-424	White	3.000 (76.2)	2.000 (50.8)	1	500	B30-R4300
i3300, BBP33	Fig. 2	B33-20-424	B-424	White	3.000 (76.2)	5.000 (127)	1	250	B30-R4300
i3300, BBP33	Fig. 2	B33-55-424	B-424	White	4.000 (101.6)	2.000 (50.8)	1	750	B30-R4300
i3300, BBP33	Fig. 2	B33-25-424	B-424	White	4.000 (101.6)	6.000 (152.4)	1	350	B30-R4300
S3000, S3100, i3300, BBP35, BBP37	✗ Fig. 3	B30C-4000-424	B-424	White	4.000 (101.6)	150 ft. (45.7 m)	1 roll (cont.)		B30-R4300

Polypropylene Labels (B-425)

- General labeling material for indoor use
- Outstanding chemical and solvent resistance and print performance
- Not recommended for prolonged outdoor use

Service temp: -94° F to 212° F
Agency approvals:

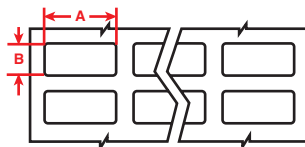

Figure 1

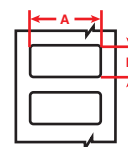

Figure 2



Fits Printers	Figure	Catalog #	B#	Color	Label Width A Inch (mm)	Label Height B Inch (mm)	Labels Per Row	Labels Per Roll	Rec. Ribbon
i3300, BBP33	Fig. 1	B33-5-425	B-425	White	1.000 (25.4)	0.500 (12.7)	3	5000	B30-R4300
i3300, BBP33	Fig. 2	B33-17-425	B-425	White	2.000 (50.8)	1.000 (25.4)	1	1500	B30-R4300
i3300, BBP33	Fig. 2	B33-18-425	B-425	White	3.000 (76.2)	1.000 (25.4)	1	1500	B30-R4300
i3300, BBP33	Fig. 2	B33-19-425	B-425	White	3.000 (76.2)	2.000 (50.8)	1	500	B30-R4300

✗ Compatible with BBP37 XY cutter.

*All supplies listed are compatible with the following printers unless otherwise noted:
BradyPrinter S3000, S3100, i3300, BBP³⁰, BBP³¹, BBP³³, BBP³⁵ and BBP³⁷ printers.

B30- and B33-Series Materials

BradyID.com/s36

Standard Polyimide Labels (B-724 and B-727)

Top- or bottom-side component ID or board ID labels that withstand the various processes, fluxes and cleaning solvents encountered in the manufacture of printed circuit boards

B-727: Service temp: -94° F to 212° F
 (short burst max temp: 80 sec at 572° F, 5 min at 500° F, 2 hrs at 338° F)
 Agency approvals:  RoHS

B-724: Service temp: -94° F to 518° F
 (short burst max temp: 80 sec at 626° F, 5 min at 536° F)
 Agency approvals: **RoHS**

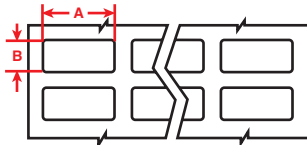

Figure 1

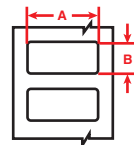

Figure 2

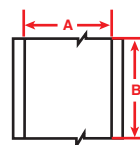

Figure 3

Fits Printers	Figure	Catalog #	B#	Color	Label Width A Inch (mm)	Label Height B Inch (mm)	Labels Per Row	Labels Per Roll	Rec. Ribbon
Standard temperature (B-727 gloss white):									
i3300, BBP33	Fig. 1	B33-11-727	B-727	Gloss White	0.250 (6.35)	0.250 (6.4)	12	5000	B30-R6000
i3300, BBP33	Fig. 1	B33-38-727	B-727	Gloss White	0.375 (9.5)	0.375 (9.5)	9	5000	B30-R6000
i3300, BBP33	Fig. 1	B33-149-727	B-727	Gloss White	0.500 (12.7)	0.500 (12.7)	4	5000	B30-R6000
i3300, BBP33	Fig. 1	B33-1-727	B-727	Gloss White	0.750 (19.1)	0.250 (6.4)	4	5000	B30-R6000
i3300, BBP33	Fig. 2	B33-49-727	B-727	Gloss White	0.900 (22.9)	0.250 (6.4)	1	5000	B30-R6000
i3300, BBP33	Fig. 1	B33-2-727	B-727	Gloss White	0.900 (22.9)	0.250 (6.4)	3	5000	B30-R6000
i3300, BBP33	Fig. 2	B33-103-727	B-727	Gloss White	1.000 (25.4)	0.250 (6.4)	1	5000	B30-R6000
i3300, BBP33	Fig. 2	B33-58-727	B-727	Gloss White	1.000 (25.4)	0.375 (9.5)	1	4000	B30-R6000
i3300, BBP33	Fig. 2	B33-59-727	B-727	Gloss White	1.000 (25.4)	0.500 (12.7)	1	2500	B30-R6000
i3300, BBP33	Fig. 2	B33-43-727	B-727	Gloss White	1.250 (31.8)	0.250 (6.4)	1	5000	B30-R6000
i3300, BBP33	Fig. 2	B33-44-727	B-727	Gloss White	1.375 (34.9)	0.250 (6.4)	1	5000	B30-R6000
i3300, BBP33	Fig. 2	B33-45-727	B-727	Gloss White	1.500 (38.1)	0.250 (6.4)	1	5000	B30-R6000
i3300, BBP33	Fig. 2	B33-72-727	B-727	Gloss White	1.750 (44.5)	0.250 (6.4)	1	5000	B30-R6000
S3000, S3100, i3300, BBP35, BBP37	⊗ Fig. 3	B30C-4000-727	B-727	Gloss White	4.000 (101.6)	130 ft. (39.6 m)	1 roll (cont.)		B30-R6000
Extremely high temperature (B-724 matte amber):									
i3300, BBP33	Fig. 1	B33-149-724	B-724	Matte Amber	0.500 (12.7)	0.500 (12.7)	4	5000	B30-R4300
i3300, BBP33	Fig. 2	B33-46-724	B-724	Matte Amber	0.750 (19.1)	0.250 (6.4)	1	5000	B30-R4300
i3300, BBP33	Fig. 1	B33-1-724	B-724	Matte Amber	0.750 (19.1)	0.250 (6.4)	4	5000	B30-R4300
i3300, BBP33	Fig. 1	B33-2-724	B-724	Matte Amber	0.900 (22.9)	0.250 (6.4)	3	5000	B30-R4300
i3300, BBP33	Fig. 2	B33-43-724	B-724	Matte Amber	1.250 (31.8)	0.250 (6.4)	1	5000	B30-R4300
i3300, BBP33	Fig. 1	B33-4-724	B-724	Matte Amber	1.500 (38.1)	0.250 (6.4)	2	5000	B30-R4300
S3000, S3100, i3300, BBP35, BBP37	⊗ Fig. 3	B30C-4000-724	B-724	Matte Amber	4.000 (101.6)	130 ft. (39.6 m)	1 roll (cont.)		B30-R4300

Benchtop Printers

B30 / B33 Series

⊗ Compatible with BBP37 XY cutter.

*All supplies listed are compatible with the following printers unless otherwise noted: BradyPrinter S3000, S3100, i3300, BBP®30, BBP®31, BBP®33, BBP®35 and BBP®37 printers.

B30- and B33-Series Materials

BradyID.com/s36

Static Dissipative Polyimide Labels (B-717, B-718 and B-719)

- Circuit board and electronic component identification with static dissipative adhesive and release liner with surface resistivity values recommended for dissipative ESD packaging
- Complies with EIA-541 packaging material standards for ESD sensitive items
- For top- or bottom-side component or board identification

Service temp: -94° F to 212° F (short burst max temp:
80 sec at 572° F, 5 min at 500° F, 2 hrs at 338° F)
Agency approvals:  

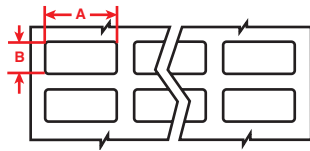
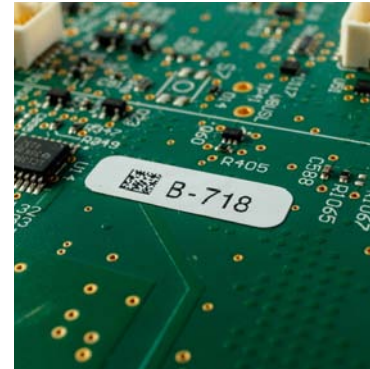

Figure 1

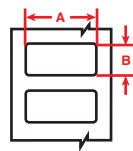

Figure 2

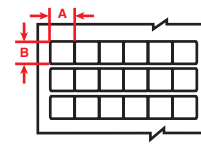



Figure 4

Fits Printers	Figure	Catalog #	B#	Color	Label Width A Inch (mm)	Label Height B Inch (mm)	Labels Per Row	Labels Per Roll	Rec. Ribbon
Standard thickness (B-717 gloss white):									
i3300, BBP33	Fig. 2	* B33-46-717	B-717	Gloss White	0.750 (19.1)	0.250 (6.4)	1	5000	B30-R6000
i3300, BBP33	Fig. 2	* B33-103-717	B-717	Gloss White	1.000 (25.4)	0.250 (6.4)	1	5000	B30-R6000
i3300, BBP33	Fig. 2	* B33-43-717	B-717	Gloss White	1.250 (31.8)	0.250 (6.4)	1	5000	B30-R6000
i3300, BBP33	Fig. 2	* B33-45-717	B-717	Gloss White	1.500 (38.1)	0.250 (6.4)	1	5000	B30-R6000
Low-profile label (B-718 gloss white):									
i3300, BBP33	Fig. 4	* B33-11-718	B-718	Gloss White	0.250 (6.4)	0.250 (6.4)	12	1500	B30-R6000
i3300, BBP33	Fig. 1	* B33-38-718	B-718	Gloss White	0.375 (9.5)	0.375 (9.5)	9	5000	B30-R6000
i3300, BBP33	Fig. 1	* B33-149-718	B-718	Gloss White	0.500 (12.7)	0.500 (12.7)	4	5000	B30-R6000
i3300, BBP33	Fig. 1	* B33-1-718	B-718	Gloss White	0.750 (19.1)	0.250 (6.4)	4	5000	B30-R6000
i3300, BBP33	Fig. 2	* B33-46-718	B-718	Gloss White	0.750 (19.1)	0.250 (6.4)	1	5000	B30-R6000
i3300, BBP33	Fig. 2	* B33-49-718	B-718	Gloss White	0.900 (22.9)	0.250 (6.4)	1	5000	B30-R6000
i3300, BBP33	Fig. 2	* B33-43-718	B-718	Gloss White	1.250 (31.8)	0.250 (6.4)	1	5000	B30-R6000
i3300, BBP33	Fig. 2	* B33-45-718	B-718	Gloss White	1.500 (38.1)	0.250 (6.4)	1	5000	B30-R6000
i3300, BBP33	Fig. 2	* B33-72-718	B-718	Gloss White	1.750 (44.5)	0.250 (6.4)	1	5000	B30-R6000
Low-profile label to prevent sticking of solder balls (B-719 matte white):									
i3300, BBP33	Fig. 1	* B33-38-719	B-719	Matte White	0.375 (9.5)	0.375 (9.5)	9	5000	B30-R6000
i3300, BBP33	Fig. 2	* B33-46-719	B-719	Matte White	0.750 (19.1)	0.250 (6.4)	1	5000	B30-R6000
i3300, BBP33	Fig. 1	* B33-2-719	B-719	Matte White	0.900 (22.9)	0.250 (6.4)	3	5000	B30-R6000
i3300, BBP33	Fig. 2	* B33-43-719	B-719	Matte White	1.250 (31.8)	0.250 (6.4)	1	5000	B30-R6000

*  **WARNING:** Cancer www.P65Warnings.ca.gov

✕ Compatible with BBP37 XY cutter.

*All supplies listed are compatible with the following printers unless otherwise noted:
BradyPrinter S3000, S3100, i3300, BBP[®]30, BBP[®]31, BBP[®]33, BBP[®]35 and BBP[®]37 printers.

B30- and B33-Series Materials

BradyID.com/s36

Panel ID Labels (B-483, B-484A, B-499, B-593 and B-595)

- Various sizes in several durable material types
- Also ideal for marking backer board, DIN rail, relays, PLCs, switches, solenoids, drive motors and other components inside panels
- All recommended materials are flexible and have high-tack adhesives for adhesion to wide variety of surfaces and components

B-483: Service temp: -40° F to 248° F Agency approvals:
 B-484A: Service temp: -40° F to 240° F Agency approvals:
 B-499: Service temp: -40° F to 193° F Agency approvals:
 B-593: Service temp: -4° F to 212° F Agency approvals:
 B-595: Service temp: -40° F to 180° F Agency approvals:

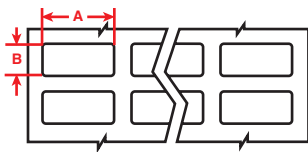

Figure 1

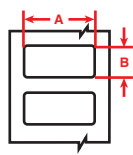

Figure 2

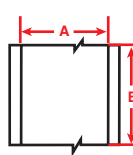

Figure 3

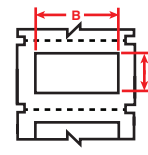

Figure 18c

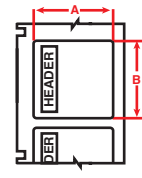



Figure 70

Fits Printers	Figure	Catalog #	B#	Color	Label Width A Inch (mm)	Label Height B Inch (mm)	Labels Per Row	Labels Per Roll	Rec. Ribbon
Nylon cloth with permanent adhesive (B-499):									
i3300, BBP33	Fig. 1	B33-68-499	B-499	White	0.500 (12.7)	0.750 (19.1)	4	1500	B30-R6000
i3300, BBP33	Fig. 1	B33-165-499	B-499	White	0.800 (20.3)	1.437 (36.5)	4	2500	B30-R6000
i3300, BBP33	Fig. 2	B33-125-499	B-499	White	0.900 (22.9)	0.500 (12.7)	1	1500	B30-R6000
i3300, BBP33	Fig. 1	B33-126-499	B-499	White	0.900 (22.9)	0.500 (12.7)	2	1500	B30-R6000
i3300, BBP33	Fig. 2	B33-163-499	B-499	White	1.000 (25.4)	0.375 (9.5)	1	1500	B30-R6000
i3300, BBP33	Fig. 1	B33-152-499	B-499	White	1.000 (25.4)	0.375 (9.5)	2	1500	B30-R6000
i3300, BBP33	Fig. 2	B33-136-499	B-499	White	1.500 (38.1)	0.750 (19.1)	1	1500	B30-R6000
i3300, BBP33	Fig. 2	B33-137-499	B-499	White	2.000 (50.8)	1.000 (25.4)	1	1100	B30-R6000
i3300, BBP33	Fig. 2	B33-125-499	B-499	White	2.000 (50.8)	0.250 (6.4)	1	1500	B30-R6000
Polyester with ultra-aggressive adhesive for highly textured and low surface energy surfaces (B-483):									
i3300, BBP33	Fig. 1	B33-149-483	B-483	White	0.500 (12.7)	0.500 (12.7)	4	5000	B30-R6000
i3300, BBP33	Fig. 1	B33-5-483	B-483	White	1.000 (25.4)	0.500 (12.7)	3	5000	B30-R6000
i3300, BBP33	Fig. 2	B33-17-483	B-483	White	2.000 (50.8)	1.000 (25.4)	1	1500	B30-R6000
i3300, BBP33	Fig. 2	B33-7-483	B-483	White	2.750 (69.9)	1.250 (31.8)	1	1000	B30-R6000
i3300, BBP33	Fig. 2	B33-18-483	B-483	White	3.000 (76.2)	1.000 (25.4)	1	1500	B30-R6000
i3300, BBP33	Fig. 2	B33-19-483	B-483	White	3.000 (76.2)	2.000 (50.8)	1	500	B30-R6000
i3300, BBP33	Fig. 2	B33-55-483	B-483	White	4.000 (101.6)	2.000 (50.8)	1	750	B30-R6000
Polyester with ultra-aggressive adhesive and pliable for conforming to angular surfaces (B-484A):									
i3300, BBP33	Fig. 2	B33-125-484	B-484A	White	0.900 (22.9)	0.500 (12.7)	1	1500	B30-R6000
i3300, BBP33	Fig. 1	B33-5-484	B-484A	White	1.000 (25.4)	0.500 (12.7)	3	5000	B30-R6000
i3300, BBP33	Fig. 2	B33-136-484	B-484A	White	1.500 (38.1)	0.750 (19.1)	1	1500	B30-R6000
i3300, BBP33	Fig. 2	B33-17-484	B-484A	White	2.000 (50.8)	1.000 (25.4)	1	1500	B30-R6000
i3300, BBP33	Fig. 2	B33-18-484	B-484A	White	3.000 (76.2)	1.000 (25.4)	1	1500	B30-R6000
i3300, BBP33	Fig. 2	B33-19-484	B-484A	White	3.000 (76.2)	2.000 (50.8)	1	500	B30-R6000
Raised profile polyester with ultra-aggressive adhesive (B-593):									
All*	Fig. 18c	B30EP-171-593-WT	B-593	White	0.490 (12.5)	1.060 (26.9)	1	500	B30-R6000
All*	Fig. 18c	B30EP-171-593-BK	B-593	Black	0.490 (12.5)	1.060 (26.9)	1	500	B30-R6000
Pre-printed vinyl with permanent adhesive and is conformable and indoor / outdoor grade (B-595):									
All*	Fig. 70	B30-241-595-ANSIDA	B-595		2.250 (57.5)	3.000 (76.2)	1	300	B30-R10000
All*	Fig. 70	B30-25-595-ANSIDA	B-595		4.000 (101.6)	6.000 (152.4)	1	175	B30-R10000
All*	Fig. 70	B30-241-595-ANSIWA	B-595		2.250 (57.5)	3.000 (76.2)	1	300	B30-R10000
All*	Fig. 70	B30-25-595-ANSIWA	B-595		4.000 (101.6)	6.000 (152.4)	1	175	B30-R10000

*All supplies listed are compatible with the following printers unless otherwise noted: BradyPrinter S3000, S3100, i3300, BBP[®]30, BBP[®]31, BBP[®]33, BBP[®]35 and BBP[®]37 printers.

Self-Laminating Wire and Cable Labels (B-427)

- Brady's most popular wire marker
- Features white printable area with clear tail that wraps around marker to protect text
- Superior resistance to abrasion, handling, solvents, water, oil and dirt
- Vinyl with permanent acrylic adhesive designed specifically for tightly curved surfaces

Service temp: -40° F to 158° F
Agency approvals:  

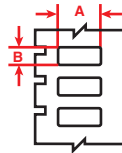

Figure 9a

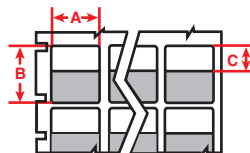

Figure 12

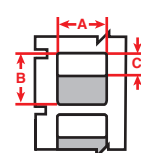

Figure 14

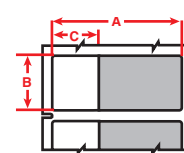

Figure 15

Fits Printers	Figure	Catalog #	B#	Color	Label Width A Inch (mm)	Label Height B Inch (mm)	Print Area Height F Inch (mm)	Labels Per Row	Labels Per Roll	Rec. Ribbon
i3300, BBP33	Fig. 12	B33-80-427	B-427	White	0.500 (12.7)	0.750 (19.1)	0.375 (9.5)	4	2500	B30-R4300
i3300, BBP33	Fig. 12	B33-113-427	B-427	White	0.500 (12.7)	1.000 (25.4)	0.375 (9.5)	4	2500	B30-R4300
i3300, BBP33	Fig. 12	B33-8-427	B-427	White	0.500 (12.7)	1.437 (36.5)	0.500 (12.7)	5	5000	B30-R4300
i3300, BBP33	Fig. 12	B33-56-427	B-427	White	0.750 (19.1)	0.937 (23.8)	0.375 (9.5)	4	5000	B30-R4300
i3300, BBP33	Fig. 12	B33-73-427	B-427	White	0.750 (19.1)	1.750 (44.6)	0.500 (12.7)	4	3500	B30-R4300
i3300, BBP33	Fig. 12	B33-74-427	B-427	White	0.800 (20.3)	1.437 (36.5)	0.500 (12.7)	4	4000	B30-R4300
i3300, BBP33	Fig. 12	B33-115-427	B-427	White	1.000 (25.4)	0.750 (19.1)	0.375 (9.5)	2	2500	B30-R4300
i3300, BBP33	Fig. 12	B33-116-427	B-427	White	1.000 (25.4)	1.000 (25.4)	0.375 (9.5)	2	2500	B30-R4300
i3300, BBP33	Fig. 12	B33-9-427	B-427	White	1.000 (25.4)	1.437 (36.5)	0.500 (12.7)	3	2500	B30-R4300
i3300, BBP33	Fig. 12	B33-75-427	B-427	White	1.000 (25.4)	2.250 (57.2)	0.750 (19.1)	2	1400	B30-R4300
i3300, BBP33	Fig. 15	B33-131-427	B-427	White	1.000 (25.4)	2.625 (66.7)	1.000 (25.4)	1	1500	B30-R4300
i3300, BBP33	Fig. 12	B33-10-427	B-427	White	1.000 (25.4)	3.750 (95.3)	1.000 (25.4)	3	1200	B30-R4300
i3300, BBP33	Fig. 12	B33-81-427	B-427	White	1.000 (25.4)	6.000 (152.4)	1.500 (38.1)	2	500	B30-R4300
i3300, BBP33	Fig. 9a*	B33-135-427AW	B-427	All White*	1.500 (38.1)	0.750 (19.1)	-	1	1500	B30-R4300
i3300, BBP33	Fig. 14	B33-118-427	B-427	White	1.500 (38.1)	1.000 (25.4)	0.375 (9.5)	1	1250	B30-R4300
i3300, BBP33	Fig. 14	B33-119-427	B-427	White	1.500 (38.1)	1.500 (38.1)	0.500 (12.7)	1	1000	B30-R4300
i3300, BBP33	Fig. 14	B33-272-427	B-427	White	1.500 (38.1)	2.250 (57.2)	0.750 (19.1)	1	700	B30-R4300
i3300, BBP33	Fig. 14	B33-120-427	B-427	White	1.750 (44.5)	1.000 (25.4)	0.375 (9.5)	1	1250	B30-R4300
i3300, BBP33	Fig. 14	B33-121-427	B-427	White	1.750 (44.5)	1.500 (38.1)	0.500 (12.7)	1	1000	B30-R4300
i3300, BBP33	Fig. 14	B33-273-427	B-427	White	1.750 (44.5)	2.250 (57.2)	0.750 (19.1)	1	500	B30-R4300
i3300, BBP33	Fig. 9a*	B33-137-427AW	B-427	All White*	2.000 (50.8)	1.000 (25.4)	-	1	1500	B30-R4300
i3300, BBP33	Fig. 14	B33-27-427	B-427	White	2.000 (50.8)	3.750 (95.3)	1.000 (25.4)	1	400	B30-R4300
i3300, BBP33	Fig. 14	B33-26-427	B-427	White	2.500 (63.5)	2.250 (57.2)	0.750 (19.1)	1	500	B30-R4300
i3300, BBP33	Fig. 14	B33-82-427	B-427	White	2.000 (50.8)	6.000 (152.4)	1.500 (38.1)	1	200	B30-R4300

* Label is all white and does not have a clear over-laminate.

Zero-Halogen Cable Markers (B-7643)

Thermoplastic polyether polyurethane is a zero-halogen high-density, thermoplastic cable marker designed for dot matrix or thermal-transfer printing.

- Meets the requirements of a halogen-free material per IEC 61249-2-21 (2003-11)
- Excellent chemical, oil and water resistance

Service temp: -40° F to 193° F (-40° C to 90° C)
Agency approvals: 

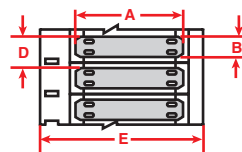

Figure 61



Fits Printers	Figure	Catalog #	B#	Color	Label Width A Inch (mm)	Label Height B Inch (mm)	Labels Per Roll	Rec. Ribbon
i3300, BBP33	Fig. 61	B33-6010-7643-WT	B-7643	White	2.36 (60)	0.39 (9.91)	500	B30-R6000
i3300, BBP33	Fig. 61	B33-7525-7643-WT	B-7643	White	2.95 (75)	0.98 (24.9)	250	B30-R6000
i3300, BBP33	Fig. 61	B33-7510-7643-WT	B-7643	White	2.95 (75)	0.39 (9.91)	500	B30-R6000
i3300, BBP33	Fig. 61	B33-7515-7643-WT	B-7643	White	2.95 (75)	0.59 (14.9)	500	B30-R6000
i3300, BBP33	Fig. 61	B33-6010-7643-YL	B-7643	Yellow	2.36 (60)	0.39 (9.91)	500	B30-R6000
i3300, BBP33	Fig. 61	B33-7525-7643-YL	B-7643	Yellow	2.95 (75)	0.98 (24.9)	250	B30-R6000
i3300, BBP33	Fig. 61	B33-7510-7643-YL	B-7643	Yellow	2.95 (75)	0.39 (9.91)	500	B30-R6000
i3300, BBP33	Fig. 61	B33-7515-7643-YL	B-7643	Yellow	2.95 (75)	0.59 (14.9)	500	B30-R6000

*All supplies listed are compatible with the following printers unless otherwise noted:
BradyPrinter S3000, S3100, i3300, BBP[®]30, BBP[®]31, BBP[®]33, BBP[®]35 and BBP[®]37 printers.

B30- and B33-Series Materials

BradyID.com/s36

High-Temp Adhesive Topcoated Polyvinylfluoride Wire and Cable Labels (B-437)

- Topcoated polyvinylfluoride label for wire and cable marking where high temperature and self-extinguishing features are required
- Heavy-duty performance with excellent resistance to water, oil and fluids
- Meets MIL-M-87958 Standard

Service temp: -94° F to 275° F
Agency approvals: **RoHS**

Also available in self-laminating format.
Contact Brady to order custom B-642 material and B30-R4300 ribbon.

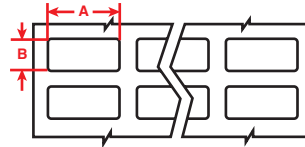

Figure 1

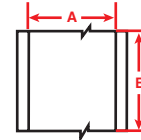

Figure 3

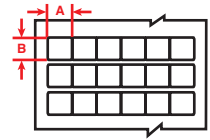

Figure 4

Fits Printers	Figure	Catalog #	B#	Color	Label Width A Inch (mm)	Label Height B Inch (mm)	Labels Per Row	Labels Per Roll	Rec. Ribbon
i3300, BBP33	Fig. 4	B33-11-437	B-437	White	0.250 (6.4)	0.250 (6.4)	12	15000	B30-R4300
i3300, BBP33	Fig. 1	B33-1-437	B-437	White	0.750 (19.1)	0.250 (6.4)	4	5000	B30-R4300
i3300, BBP33	Fig. 1	B33-2-437	B-437	White	0.900 (22.9)	0.250 (6.4)	3	5000	B30-R4300
i3300, BBP33	Fig. 1	B33-5-437	B-437	White	1.000 (25.4)	0.500 (12.7)	3	5000	B30-R4300
i3300, BBP33	Fig. 1	B33-29-437	B-437	White	1.250 (31.8)	0.375 (9.5)	2	5000	B30-R4300
i3300, BBP33	Fig. 1	B33-5-437YL	B-437	Yellow	1.000 (25.4)	0.500 (12.7)	3	5000	B30-R4300
i3300, BBP33	Fig. 1	B33-29-437YL	B-437	Yellow	1.250 (31.8)	0.375 (9.5)	2	5000	B30-R4300
Continuous Rolls:									
i3300, BBP33	Fig. 3	B33C-1000-437	B-437	White	1.000 (25.4)	85 ft. (25.9m)	1 roll (cont.)		B30-R4300
i3300, BBP33	Fig. 3	B33C-1500-437	B-437	White	1.500 (38.1)	85 ft. (25.9m)	1 roll (cont.)		B30-R4300
i3300, BBP33	Fig. 3	B33C-2000-437	B-437	White	2.000 (50.8)	85 ft. (25.9m)	1 roll (cont.)		B30-R4300
i3300, BBP33	Fig. 3	B33C-3000-437	B-437	White	3.000 (76.2)	85 ft. (25.9m)	1 roll (cont.)		B30-R4300
S3000, S3100, i3300, BBP35, BBP37	Fig. 3	B30C-4000-437	B-437	White	4.000 (101.6)	150 ft. (45.7 m)	1 roll (cont.)		B30-R4300
i3300, BBP33	Fig. 3	B33C-1000-437YL	B-437	Yellow	1.000 (25.4)	85 ft. (25.9m)	1 roll (cont.)		B30-R4300
i3300, BBP33	Fig. 3	B33C-1500-437YL	B-437	Yellow	1.500 (38.1)	85 ft. (25.9m)	1 roll (cont.)		B30-R4300
i3300, BBP33	Fig. 3	B33C-2000-437YL	B-437	Yellow	2.000 (50.8)	85 ft. (25.9m)	1 roll (cont.)		B30-R4300
i3300, BBP33	Fig. 3	B33C-3000-437YL	B-437	Yellow	3.000 (76.2)	85 ft. (25.9m)	1 roll (cont.)		B30-R4300

Benchmark Printers

Vinyl Cloth Adhesive Wire and Cable Labels (B-498)

- A vinyl cloth label for marking wires, cables and inside-panel components
- Repositionable — a highly unique adhesive and cloth construction gives excellent holding power and still allows for clean removal and reapplication
- Ideal choice for marking both ends of a wire that you may need to cut shorter before final termination

Service temp: -40° F to 175° F
Agency approvals: **UL** **RoHS** **CE**

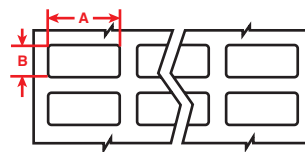

Figure 1



Fits Printers	Figure	Catalog #	B#	Color	Label Width A Inch (mm)	Label Height B Inch (mm)	Labels Per Row	Labels Per Roll	Rec. Ribbon
i3300, BBP33	Fig. 1	B33-90-498	B-498	White	0.250 (6.4)	1.437 (36.5)	6	2500	B30-R6200
i3300, BBP33	Fig. 1	B33-68-498	B-498	White	0.500 (12.7)	0.750 (19.1)	4	5000	B30-R6200
i3300, BBP33	Fig. 1	B33-87-498	B-498	White	0.500 (12.7)	1.437 (36.5)	6	2500	B30-R6200
i3300, BBP33	Fig. 1	B33-1-498	B-498	White	0.750 (19.1)	0.250 (6.4)	4	5000	B30-R6200
i3300, BBP33	Fig. 1	B33-91-498	B-498	White	0.750 (19.1)	0.937 (23.8)	4	2500	B30-R6200
i3300, BBP33	Fig. 1	B33-95-498	B-498	White	0.800 (20.3)	1.437 (36.5)	3	2300	B30-R6200
i3300, BBP33	Fig. 1	B33-5-498	B-498	White	1.000 (25.4)	0.500 (12.7)	3	5000	B30-R6200
i3300, BBP33	Fig. 1	B33-88-498	B-498	White	1.000 (25.4)	0.750 (19.1)	2	2500	B30-R6200
i3300, BBP33	Fig. 1	B33-89-498	B-498	White	1.000 (25.4)	1.437 (36.5)	3	2300	B30-R6200

✕ Compatible with BBP37 XY cutter.

*All supplies listed are compatible with the following printers unless otherwise noted: BradyPrinter S3000, S3100, i3300, BBP®30, BBP®31, BBP®33, BBP®35 and BBP®37 printers.

B30 / B33 Series

B30- and B33-Series Materials

BradyID.com/s36

High-Temp Adhesive Polyimide Wire and Cable Labels (B-472)

- Top-coated polyimide label for wire and cable marking applications where high temperature and self-extinguishing features are required
- Heavy-duty performance with excellent resistance to water, oil and other fluids

Service temp: -94° F to 320° F
Agency approvals: RoHS

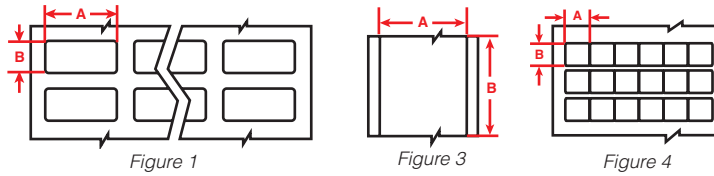

Fits Printers	Figure	Catalog #	B#	Color	Label Width A Inch (mm)	Label Height B Inch (mm)	Labels Per Row	Labels Per Roll	Rec. Ribbon
i3300, BBP33	Fig. 4	B33-11-472	B-472	White	0.250 (6.4)	0.250 (6.4)	12	15000	B30-R4300
i3300, BBP33	Fig. 1	B33-1-472	B-472	White	0.750 (19.1)	0.250 (6.4)	4	5000	B30-R4300
i3300, BBP33	Fig. 1	B33-2-472	B-472	White	0.900 (22.9)	0.250 (6.4)	3	5000	B30-R4300
i3300, BBP33	Fig. 1	B33-5-472	B-472	White	1.000 (25.4)	0.500 (12.7)	3	5000	B30-R4300
i3300, BBP33	Fig. 1	B33-29-472	B-472	White	1.250 (31.8)	0.375 (9.5)	2	5000	B30-R4300
i3300, BBP33	Fig. 1	B33-5-472YL	B-472	Yellow	1.000 (25.4)	0.500 (12.7)	3	5000	B30-R4300
i3300, BBP33	Fig. 1	B33-29-472YL	B-472	Yellow	1.250 (31.8)	0.375 (9.5)	2	5000	B30-R4300
Continuous Rolls:									
i3300, BBP33	Fig. 3	B33C-1000-472	B-472	White	1.000 (25.4)	85 ft. (25.9 m)	1 roll (cont.)		B30-R4300
i3300, BBP33	Fig. 3	B33C-1500-472	B-472	White	1.500 (38.1)	85 ft. (25.9 m)	1 roll (cont.)		B30-R4300
i3300, BBP33	Fig. 3	B33C-2000-472	B-472	White	2.000 (50.8)	85 ft. (25.9 m)	1 roll (cont.)		B30-R4300
i3300, BBP33	Fig. 3	B33C-3000-472	B-472	White	3.000 (76.2)	85 ft. (25.9 m)	1 roll (cont.)		B30-R4300
i3300, BBP33	Fig. 3	B33C-1000-472YL	B-472	Yellow	1.000 (25.4)	85 ft. (25.9 m)	1 roll (cont.)		B30-R4300
i3300, BBP33	Fig. 3	B33C-1500-472YL	B-472	Yellow	1.500 (38.1)	85 ft. (25.9 m)	1 roll (cont.)		B30-R4300
i3300, BBP33	Fig. 3	B33C-2000-472YL	B-472	Yellow	2.000 (50.8)	85 ft. (25.9 m)	1 roll (cont.)		B30-R4300
i3300, BBP33	Fig. 3	B33C-3000-472YL	B-472	Yellow	3.000 (76.2)	85 ft. (25.9 m)	1 roll (cont.)		B30-R4300

Terminal Block Adhesive Strips (B-498)

- Specially designed narrow-width continuous label for alignment on terminal blocks and patch panels
- Highly unique adhesive and vinyl cloth construction gives excellent holding power and still allows for clean removal and reapplication

Service temp: -40° F to 175° F
Agency approvals: UL RoHS

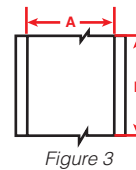

Fits Printers	Figure	Catalog #	B#	Color	Label Width A Inch (mm)	Roll Length B Feet (m)	Labels Per Roll	Rec. Ribbon
i3300, BBP33	Fig. 3	B33C-312-498	B-498	White	0.312 (7.9)	85 (25.9)	1 roll (cont.)	B30-R6200
i3300, BBP33	Fig. 3	B33C-375-498	B-498	White	0.375 (9.5)	85 (25.9)	1 roll (cont.)	B30-R6200

Patch Panel Adhesive Strips (B-422)

- Continuous supply makes labeling patch panels and other datacomm components quick and easy
- Aggressive adhesive suitable for rough, highly-textured and powder-coated surfaces as well as smooth surfaces

Service temp: -40° F to 212° F
Agency approvals: UL RoHS

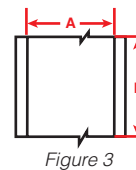

Fits Printers	Figure	Catalog #	B#	Color	Label Width A Inch (mm)	Roll Length B Feet (m)	Labels Per Roll	Rec. Ribbon
i3300, BBP33	Fig. 3	B33C-312-422	B-422	White	0.312 (7.9)	85 (25.9)	1 roll (cont.)	B30-R6000
i3300, BBP33	Fig. 3	B33C-375-422	B-422	White	0.375 (9.5)	85 (25.9)	1 roll (cont.)	B30-R6000

*All supplies listed are compatible with the following printers unless otherwise noted:
BradyPrinter S3000, S3100, i3300, BBP[®]30, BBP[®]31, BBP[®]33, BBP[®]35 and BBP[®]37 printers.

B30- and B33-Series Materials

BradyID.com/s36

PermaSleeve® PS Polyolefin Wire Markers (B-342)

Military / industrial grade sleeves offer the ultimate in marker durability, permanence and aesthetic appearance. 3:1 heat-shrinkable markers fit snugly around wires, are fade-resistant and flame-retardant.

Meets specifications:

- SSAE-AS-23053/5
- SAE-AS-81531

Tested per:

- ASTM E162
- ASTM E662
- MIL-STD-202

Service temp: -40° F to 275° F
(short burst max temp: 5 min at 500° F, 24 hrs at 350° F)
Agency approvals:

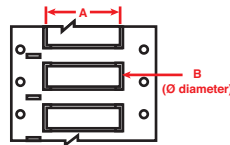

Figure 20

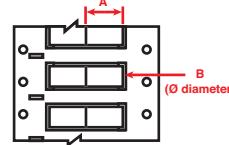

Figure 20-2
(perforated)



Benchtop Printers

B30 / B33 Series

Fits Printers	Figure	Catalog #	Material	For Wire Gauge (approx.)	Range For Wire Diameters Inch (mm)	Supplied Diameter B Inch (mm)	Recovered Diameter Inch (mm)	Recovered Wall Thickness Inch (mm)	Sleeves Per Row	Per Roll	Rec. Ribbon
3:1 Shrink ratio, single-side printable, 2 inch sleeve width (dimension A):											
13300, BBP33	Fig. 20	* B33-94-2-342	B-342	Wt. 28 to 20	0.023 (0.6) - 0.080 (2.0)	0.094 (2.4)	0.024 (0.6)	.024 (0.6) +/- .003 (0.07)	1	1000	B30-R4300
13300, BBP33	Fig. 20	* B33-125-2-342	B-342	Wt. 22 to 16	0.046 (1.2) - 1.110 (2.8)	0.125 (3.2)	0.047 (1.2)	.020 (0.5) +/- .003 (0.07)	1	1000	B30-R4300
13300, BBP33	Fig. 20	* B33-187-2-342	B-342	Wt. 20 to 10	0.062 (1.6) - 0.150 (3.8)	0.187 (4.7)	0.062 (1.6)	.020 (0.5) +/- .003 (0.07)	1	750	B30-R4300
13300, BBP33	Fig. 20	* B33-250-2-342	B-342	Wt. 16 to 8	0.094 (2.4) - 0.215 (5.5)	0.250 (6.4)	0.093 (2.4)	.025 (0.6) +/- .003 (0.07)	1	500	B30-R4300
13300, BBP33	Fig. 20	* B33-375-2-342	B-342	Wt. 12 to 4	0.125 (3.2) - 0.320 (8.1)	0.375 (9.5)	0.125 (3.1)	.025 (0.6) +/- .003 (0.07)	1	500	B30-R4300
13300, BBP33	Fig. 20	* B33-500-2-342	B-342	Wt. 8 to 1	0.187 (4.8) - 0.450 (11.4)	0.500 (12.7)	0.187 (4.7)	.025 (0.6) +/- .003 (0.07)	1	350	B30-R4300
13300, BBP33	Fig. 20	* B33-750-2-342	B-342	Wt. 6 to 4/0	0.250 (6.4) - 0.700 (17.8)	0.750 (19.0)	0.250 (6.4)	.025 (0.6) +/- .003 (0.07)	1	250	B30-R4300
13300, BBP33	Fig. 20	* B33-1000-2-342	B-342	Wt. 2 to 0.950 dia	0.333 (8.5) - 0.950 (24.1)	1.000 (25.4)	0.375 (9.5)	.036 (0.9) +/- .003 (0.07)	1	250	B30-R4300
13300, BBP33	Fig. 20	* B33-1500-2-342	B-342	Wt. n/a	0.500 (12.7) - 1.400 (35.6)	1.500 (38.1)	0.500 (12.7)	.035 (0.9) +/- .003 (0.07)	1	150	B30-R4300
13300, BBP33	Fig. 20	* B33-94-2-342YL	B-342	Ylw. 28 to 20	0.023 (0.6) - 0.080 (2.0)	0.094 (2.4)	0.024 (0.6)	.024 (0.6) +/- .003 (0.07)	1	1000	B30-R4300
13300, BBP33	Fig. 20	* B33-125-2-342YL	B-342	Ylw. 22 to 16	0.046 (1.2) - 1.110 (2.8)	0.125 (3.2)	0.047 (1.2)	.020 (0.5) +/- .003 (0.07)	1	1000	B30-R4300
13300, BBP33	Fig. 20	* B33-187-2-342YL	B-342	Ylw. 20 to 10	0.062 (1.6) - 0.150 (3.8)	0.187 (4.7)	0.062 (1.6)	.020 (0.5) +/- .003 (0.07)	1	750	B30-R4300
13300, BBP33	Fig. 20	* B33-250-2-342YL	B-342	Ylw. 16 to 8	0.094 (2.4) - 0.215 (5.5)	0.250 (6.4)	0.093 (2.4)	.025 (0.6) +/- .003 (0.07)	1	500	B30-R4300
13300, BBP33	Fig. 20	* B33-375-2-342YL	B-342	Ylw. 12 to 4	0.125 (3.2) - 0.320 (8.1)	0.375 (9.5)	0.125 (3.1)	.025 (0.6) +/- .003 (0.07)	1	500	B30-R4300
13300, BBP33	Fig. 20	* B33-500-2-342YL	B-342	Ylw. 8 to 1	0.187 (4.8) - 0.450 (11.4)	0.500 (12.7)	0.187 (4.7)	.025 (0.6) +/- .003 (0.07)	1	350	B30-R4300
13300, BBP33	Fig. 20	* B33-750-2-342YL	B-342	Ylw. 6 to 4/0	0.250 (6.4) - 0.700 (17.8)	0.750 (19.0)	0.250 (6.4)	.025 (0.6) +/- .003 (0.07)	1	250	B30-R4300
13300, BBP33	Fig. 20	* B33-1000-2-342YL	B-342	Ylw. 2 to 0.950 dia	0.333 (8.5) - 0.950 (24.1)	1.000 (25.4)	0.375 (9.5)	.036 (0.9) +/- .003 (0.07)	1	250	B30-R4300
13300, BBP33	Fig. 20	* B33-1500-2-342YL	B-342	Ylw. n/a	0.500 (12.7) - 1.400 (35.6)	1.500 (38.1)	0.500 (12.7)	.035 (0.9) +/- .003 (0.07)	1	150	B30-R4300
13300, BBP33	Fig. 20	* B33-1500-2-342BK	B-342	Blk. n/a	0.500 (12.7) - 1.400 (35.6)	1.500 (38.1)	0.500 (12.7)	.035 (0.9) +/- .003 (0.07)	1	150	B30-R4500-SV
3:1 Shrink ratio, single-side printable, perforated material resulting in two 1 inch width sleeves (dimension A):											
13300, BBP33	Fig. 20-2	* B33-94-2-342-2	B-342	Wt. 28 to 20	0.023 (0.6) - 0.080 (2.0)	0.094 (2.4)	0.024 (0.6)	.024 (0.6) +/- .003 (0.07)	2	2000	B30-R4300
13300, BBP33	Fig. 20-2	* B33-125-2-342-2	B-342	Wt. 22 to 16	0.046 (1.2) - 0.111 (2.8)	0.125 (3.2)	0.047 (1.2)	.020 (0.5) +/- .003 (0.07)	2	2000	B30-R4300
13300, BBP33	Fig. 20-2	* B33-187-2-342-2	B-342	Wt. 20 to 10	0.062 (1.6) - 0.150 (3.8)	0.187 (4.7)	0.062 (1.6)	.020 (0.5) +/- .003 (0.07)	2	1500	B30-R4300
13300, BBP33	Fig. 20-2	* B33-250-2-342-2	B-342	Wt. 16 to 8	0.094 (2.4) - 0.215 (5.5)	0.250 (6.4)	0.093 (2.4)	.025 (0.6) +/- .003 (0.07)	2	1000	B30-R4300
13300, BBP33	Fig. 20-2	* B33-375-2-342-2	B-342	Wt. 12 to 4	0.125 (3.2) - 0.320 (8.1)	0.375 (9.5)	0.125 (3.1)	.025 (0.6) +/- .003 (0.07)	2	1000	B30-R4300
13300, BBP33	Fig. 20-2	* B33-500-2-342-2	B-342	Wt. 8 to 1	0.187 (4.8) - 0.450 (11.4)	0.500 (12.7)	0.119 (3.0)	.025 (0.6) +/- .003 (0.07)	2	700	B30-R4300
13300, BBP33	Fig. 20-2	* B33-750-2-342-2	B-342	Wt. 6 to 4/0	0.250 (6.4) - 0.700 (17.8)	0.750 (19.1)	0.250 (6.35)	.025 (0.6) +/- .003 (0.07)	2	500	B30-R4300
13300, BBP33	Fig. 20-2	* B33-1000-2-342-2	B-342	Wt. 2 to 0.950 dia	0.333 (8.5) - 0.950 (24.1)	1.000 (25.4)	0.375 (9.5)	.036 (0.9) +/- .003 (0.07)	2	500	B30-R4300
13300, BBP33	Fig. 20-2	* B33-1500-2-342-2	B-342	Wt. n/a	0.500 (12.7) - 1.400 (35.6)	1.500 (38.1)	0.500 (12.7)	.035 (0.9) +/- .003 (0.07)	2	150	B30-R4300
13300, BBP33	Fig. 20-2	* B33-94-2-342YL-2	B-342	Ylw. 28 to 20	0.023 (0.6) - 0.080 (2.0)	0.094 (2.4)	0.024 (0.6)	.024 (0.6) +/- .003 (0.07)	2	2000	B30-R4300
13300, BBP33	Fig. 20-2	* B33-125-2-342YL-2	B-342	Ylw. 22 to 16	0.046 (1.2) - 0.111 (2.8)	0.125 (3.2)	0.047 (1.2)	.020 (0.5) +/- .003 (0.07)	2	2000	B30-R4300
13300, BBP33	Fig. 20-2	* B33-750-2-342YL-2	B-342	Ylw. 6 to 4/0	0.250 (6.4) - 0.700 (17.8)	0.750 (19.1)	0.250 (6.35)	.025 (0.6) +/- .003 (0.07)	2	500	B30-R4300
13300, BBP33	Fig. 20-2	* B33-500-2-342YL-2	B-342	Ylw. 8 to 1	0.187 (4.8) - 0.450 (11.4)	0.500 (12.7)	0.119 (3.0)	.025 (0.6) +/- .003 (0.07)	2	700	B30-R4300
13300, BBP33	Fig. 20-2	* B33-1000-2-342YL-2	B-342	Ylw. 2 to 0.950 dia	0.333 (8.5) - 0.950 (24.1)	1.000 (25.4)	0.375 (9.5)	.036 (0.9) +/- .003 (0.07)	2	500	B30-R4300
13300, BBP33	Fig. 20-2	* B33-1500-2-342YL-2	B-342	Ylw. n/a	0.500 (12.7) - 1.400 (35.6)	1.500 (38.1)	0.500 (12.7)	.035 (0.9) +/- .003 (0.07)	2	300	B30-R4300

* **WARNING:** Cancer www.P65Warnings.ca.gov

*All supplies listed are compatible with the following printers unless otherwise noted: BradyPrinter S3000, S3100, i3300, BBP®30, BBP®31, BBP®33, BBP®35 and BBP®37 printers.

B-342 PermaSleeve® PS Polyolefin Wire Markers (continued)

Fits Printers	Figure	Catalog #	Material	For Wire Gauge (approx.)	Range For Wire Diameters Inch (mm)	Supplied Diameter B Inch (mm)	Recovered Diameter Inch (mm)	Recovered Wall Thickness Inch (mm)	Sleeves Per Row	Per Roll	Rec. Ribbon	
3:1 Shrink ratio, double-side printable, 2 inch sleeve width (dimension A):												
i3300, BBP33	Fig. 20	* B33D-94-2-342	B-342	Wt.	28 to 20	0.023 (0.6) - 0.080 (2.0)	0.094 (2.4)	0.024 (0.6)	.024 (0.6) +/- .003 (0.07)	1	1000	B30-R4300
i3300, BBP33	Fig. 20	* B33D-125-2-342	B-342	Wt.	22 to 16	0.046 (1.2) - 1.110 (2.8)	0.125 (3.2)	0.047 (1.2)	.020 (0.5) +/- .003 (0.07)	1	1000	B30-R4300
i3300, BBP33	Fig. 20	* B33D-125-2-342-2	B-342	Wt.	22 to 16	0.046 (1.2) - 1.110 (2.8)	0.125 (3.2)	0.047 (1.2)	.020 (0.5) +/- .003 (0.07)	2	2000	B30-R4300
i3300, BBP33	Fig. 20	* B33D-187-2-342	B-342	Wt.	20 to 10	0.062 (1.6) - 0.150 (3.8)	0.187 (4.7)	0.062 (1.6)	.020 (0.5) +/- .003 (0.07)	1	750	B30-R4300
i3300, BBP33	Fig. 20	* B33D-250-2-342	B-342	Wt.	16 to 8	0.094 (2.4) - 0.215 (5.5)	0.250 (6.4)	0.093 (2.4)	.025 (0.6) +/- .003 (0.07)	1	500	B30-R4300
i3300, BBP33	Fig. 20	* B33D-375-2-342	B-342	Wt.	12 to 4	0.125 (3.2) - 0.320 (8.1)	0.375 (9.5)	0.125 (3.1)	.025 (0.6) +/- .003 (0.07)	1	500	B30-R4300
i3300, BBP33	Fig. 20	* B33D-500-2-342	B-342	Wt.	8 to 1	0.187 (4.8) - 0.450 (11.4)	0.500 (12.7)	0.187 (4.7)	.025 (0.6) +/- .003 (0.07)	1	350	B30-R4300
i3300, BBP33	Fig. 20	* B33D-750-2-342	B-342	Wt.	6 to 4/0	0.250 (6.4) - 0.700 (17.8)	0.750 (19.0)	0.250 (6.4)	.025 (0.6) +/- .003 (0.07)	1	250	B30-R4300
i3300, BBP33	Fig. 20	* B33D-1000-2-342	B-342	Wt.	2 to 0.950 dia	0.333 (8.5) - 0.950 (24.1)	1.000 (25.4)	0.375 (9.5)	.036 (0.9) +/- .003 (0.07)	1	250	B30-R4300
i3300, BBP33	Fig. 20	* B33D-1500-2-342	B-342	Wt.	n/a	0.500 (12.7) - 1.400 (35.6)	1.500 (38.1)	0.500 (12.7)	.035 (0.9) +/- .003 (0.07)	1	150	B30-R4300
i3300, BBP33	Fig. 20	* B33D-94-2-342YL	B-342	Ylw.	28 to 20	0.023 (0.6) - 0.080 (2.0)	0.094 (2.4)	0.024 (0.6)	.024 (0.6) +/- .003 (0.07)	1	1000	B30-R4300
i3300, BBP33	Fig. 20	* B33D-125-2-342YL	B-342	Ylw.	22 to 16	0.046 (1.2) - 1.110 (2.8)	0.125 (3.2)	0.047 (1.2)	.020 (0.5) +/- .003 (0.07)	1	1000	B30-R4300
i3300, BBP33	Fig. 20	* B33D-187-2-342YL	B-342	Ylw.	20 to 10	0.062 (1.6) - 0.150 (3.8)	0.187 (4.7)	0.062 (1.6)	.020 (0.5) +/- .003 (0.07)	1	750	B30-R4300
i3300, BBP33	Fig. 20	* B33D-250-2-342YL	B-342	Ylw.	16 to 8	0.094 (2.4) - 0.215 (5.5)	0.250 (6.4)	0.093 (2.4)	.025 (0.6) +/- .003 (0.07)	1	500	B30-R4300
i3300, BBP33	Fig. 20	* B33D-375-2-342YL	B-342	Ylw.	12 to 4	0.125 (3.2) - 0.320 (8.1)	0.375 (9.5)	0.125 (3.1)	.025 (0.6) +/- .003 (0.07)	1	500	B30-R4300
i3300, BBP33	Fig. 20	* B33D-500-2-342YL	B-342	Ylw.	8 to 1	0.187 (4.8) - 0.450 (11.4)	0.500 (12.7)	0.187 (4.7)	.025 (0.6) +/- .003 (0.07)	1	350	B30-R4300
i3300, BBP33	Fig. 20	* B33D-750-2-342YL	B-342	Ylw.	6 to 4/0	0.250 (6.4) - 0.700 (17.8)	0.750 (19.0)	0.250 (6.4)	.025 (0.6) +/- .003 (0.07)	1	250	B30-R4300
i3300, BBP33	Fig. 20	* B33D-1000-2-342YL	B-342	Ylw.	2 to 0.950 dia	0.333 (8.5) - 0.950 (24.1)	1.000 (25.4)	0.375 (9.5)	.036 (0.9) +/- .003 (0.07)	1	250	B30-R4300
i3300, BBP33	Fig. 20	* B33D-1500-2-342YL	B-342	Ylw.	n/a	0.500 (12.7) - 1.400 (35.6)	1.500 (38.1)	0.500 (12.7)	.035 (0.9) +/- .003 (0.07)	1	150	B30-R4300
i3300, BBP33	Fig. 20	* B33D-94-2-342BK	B-342	Blk.	28 to 20	0.023 (0.6) - 0.080 (2.0)	0.094 (2.4)	0.024 (0.6)	.024 (0.6) +/- .003 (0.07)	1	1000	B30-R4500-SV
i3300, BBP33	Fig. 20	* B33D-125-2-342BK	B-342	Blk.	22 to 16	0.046 (1.2) - 1.110 (2.8)	0.125 (3.2)	0.047 (1.2)	.020 (0.5) +/- .003 (0.07)	1	1000	B30-R4500-SV
i3300, BBP33	Fig. 20	* B33D-187-2-342BK	B-342	Blk.	20 to 10	0.062 (1.6) - 0.150 (3.8)	0.187 (4.7)	0.062 (1.6)	.020 (0.5) +/- .003 (0.07)	1	750	B30-R4500-SV
i3300, BBP33	Fig. 20	* B33D-250-2-342BK	B-342	Blk.	16 to 8	0.094 (2.4) - 0.215 (5.5)	0.250 (6.4)	0.093 (2.4)	.025 (0.6) +/- .003 (0.07)	1	500	B30-R4500-SV
i3300, BBP33	Fig. 20	* B33D-375-2-342BK	B-342	Blk.	12 to 4	0.125 (3.2) - 0.320 (8.1)	0.375 (9.5)	0.125 (3.1)	.025 (0.6) +/- .003 (0.07)	1	500	B30-R4500-SV
i3300, BBP33	Fig. 20	* B33D-500-2-342BK	B-342	Blk.	8 to 1	0.187 (4.8) - 0.450 (11.4)	0.500 (12.7)	0.187 (4.7)	.025 (0.6) +/- .003 (0.07)	1	350	B30-R4500-SV
i3300, BBP33	Fig. 20	* B33D-750-2-342BK	B-342	Blk.	6 to 4/0	0.250 (6.4) - 0.700 (17.8)	0.750 (19.0)	0.250 (6.4)	.025 (0.6) +/- .003 (0.07)	1	250	B30-R4500-SV
i3300, BBP33	Fig. 20	* B33D-1000-2-342BK	B-342	Blk.	2 to 0.950 dia	0.333 (8.5) - 0.950 (24.1)	1.000 (25.4)	0.375 (9.5)	.036 (0.9) +/- .003 (0.07)	1	250	B30-R4500-SV
i3300, BBP33	Fig. 20	* B33D-1500-2-342BK	B-342	Blk.	n/a	0.500 (12.7) - 1.400 (35.6)	1.500 (38.1)	0.500 (12.7)	.035 (0.9) +/- .003 (0.07)	1	150	B30-R4500-SV

* **WARNING:** Cancer www.P65Warnings.ca.gov

QuickSleeve Handheld Sleeve Applicator

The QuickSleeve Handheld Sleeve Applicator is an intuitive multi-tool designed to help you quickly apply sleeves on to wires in three simple steps – just pick, slip and apply. This tool includes:

- Four specially designed slanted tubes sized for sleeve sizes 0.094, 0.125, 0.187 and 0.250 inches
- Built-in LED flashlight for use in low-lit conditions
- Terminal block sized screwdriver



Catalog #	Description	Qty.
QS	Quicksleeve Multi-Tool	1 Set

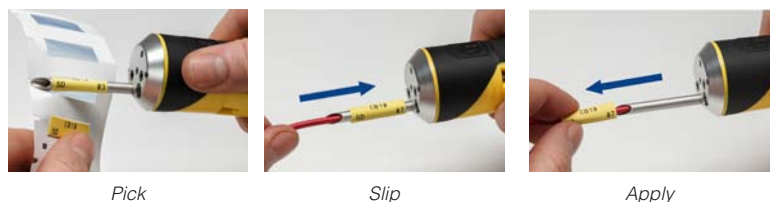

*All supplies listed are compatible with the following printers unless otherwise noted: BradyPrinter S3000, S3100, i3300, BBP®30, BBP®31, BBP®33, BBP®35 and BBP®37 printers.

B30- and B33-Series Materials

BradyID.com/s36

PermaSleeve® HT High-Temperature PVDF Wire Markers (B-345)

Military / industrial grade 2:1 heat shrinkable sleeves specifically designed for high-temperature and low-vacuum outgassing applications. Irradiated high-temp polyvinylidene fluoride (PVDF) is fade-resistant and flame-retardant.

Meets specifications:

- NASA SP-R-0022A
Outgassing Performance
- SAE-AS-81531

Tested per:

- ASTM E162
- ASTM E662
- MIL-STD-202

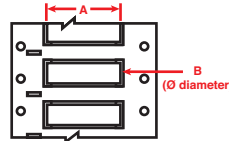

Figure 20



Service temp: -67° F to 437° F
Agency approvals: **RoHS**

Fits Printers	Figure	Catalog #	Material	For Wire Gauge (approx.)	Range For Wire Diameters Inch (mm)	Supplied Diameter B Inch (mm)	Recovered Diameter Inch (mm)	Recovered Wall Thickness Inch (mm)	Sleeves Per Row	Sleeves Per Roll	Rec. Ribbon
3:1 Shrink ratio, double-side printable, 2 inch sleeve width (dimension A):											
i3300, BBP33	Fig. 20	B33D-94-2-345	B-345	Wt. 26 to 20	0.031 (0.8) - 0.080 (2.0)	0.094 (2.4)	0.031 (0.8)	.015 (0.4) +/- .003 (0.07)	1	1000	B30-R6000
i3300, BBP33	Fig. 20	B33D-94-2-345BK	B-345	Blk. 26 to 20	0.031 (0.8) - 0.080 (2.0)	0.094 (2.4)	0.031 (0.8)	.015 (0.4) +/- .003 (0.07)	1	1000	B30-R4400-WT
2:1 Shrink ratio, double-side printable, 2 inch sleeve width (dimension A):											
i3300, BBP33	Fig. 20	B33D-125-2-345	B-345	Wt. 20 to 16	0.063 (1.6) - 0.110 (2.8)	0.125 (3.2)	0.062 (1.6)	.015 (0.4) +/- .003 (0.07)	1	1000	B30-R6000
i3300, BBP33	Fig. 20	B33D-187-2-345	B-345	Wt. 16 to 10	0.094 (2.4) - 0.150 (3.8)	0.187 (4.7)	0.093 (2.4)	.015 (0.4) +/- .003 (0.07)	1	750	B30-R6000
i3300, BBP33	Fig. 20	B33D-250-2-345	B-345	Wt. 12 to 8	0.125 (3.2) - 0.215 (5.5)	0.250 (6.4)	0.125 (3.2)	.015 (0.4) +/- .003 (0.07)	1	500	B30-R6000
i3300, BBP33	Fig. 20	B33D-375-2-345	B-345	Wt. 8 to 4	0.187 (3.2) - 0.320 (8.1)	0.375 (9.5)	0.187 (4.7)	.015 (0.4) +/- .003 (0.07)	1	500	B30-R6000
i3300, BBP33	Fig. 20	B33D-500-2-345	B-345	Wt. 6 to 1	0.250 (6.4) - 0.450 (11.4)	0.500 (12.7)	0.250 (6.4)	.015 (0.4) +/- .003 (0.07)	1	350	B30-R6000
i3300, BBP33	Fig. 20	B33D-750-2-345	B-345	Wt. 2 to 4/0	0.375 (9.5) - 0.700 (17.8)	0.750 (19.0)	0.375 (9.5)	.015 (0.4) +/- .003 (0.07)	1	250	B30-R6000
i3300, BBP33	Fig. 20	B33D-1000-2-345	B-345	Wt. 2/0 to 0.950 dia	0.450 (11.4) - 0.950 (24.1)	1.000 (25.4)	0.500 (12.7)	.017 (0.4) +/- .004 (0.1)	1	250	B30-R6000
i3300, BBP33	Fig. 20	B33D-1500-2-345	B-345	Wt. N/A	0.750 (19.1) - 1.400 (35.6)	1.500 (38.1)	0.750 (19.1)	.024 (0.6) +/- .004 (0.1)	1	150	B30-R6000
i3300, BBP33	Fig. 20	B33D-125-2-345BK	B-345	Blk. 20 to 16	0.063 (1.6) - 0.110 (2.8)	0.125 (3.2)	0.062 (1.6)	.015 (0.4) +/- .003 (0.07)	1	1000	B30-R4400-WT
i3300, BBP33	Fig. 20	B33D-187-2-345BK	B-345	Blk. 16 to 10	0.094 (2.4) - 0.150 (3.8)	0.187 (4.7)	0.093 (2.4)	.015 (0.4) +/- .003 (0.07)	1	750	B30-R4400-WT
i3300, BBP33	Fig. 20	B33D-250-2-345BK	B-345	Blk. 12 to 8	0.125 (3.2) - 0.215 (5.5)	0.250 (6.4)	0.125 (3.2)	.015 (0.4) +/- .003 (0.07)	1	500	B30-R4400-WT
i3300, BBP33	Fig. 20	B33D-375-2-345BK	B-345	Blk. 8 to 4	0.187 (3.2) - 0.320 (8.1)	0.375 (9.5)	0.187 (4.7)	.015 (0.4) +/- .003 (0.07)	1	500	B30-R4400-WT
i3300, BBP33	Fig. 20	B33D-500-2-345BK	B-345	Blk. 6 to 1	0.250 (6.4) - 0.450 (11.4)	0.500 (12.7)	0.250 (6.4)	.015 (0.4) +/- .003 (0.07)	1	350	B30-R4400-WT
i3300, BBP33	Fig. 20	B33D-750-2-345BK	B-345	Blk. 3 to 4/0	0.375 (9.5) - 0.700 (17.8)	0.750 (19.0)	0.375 (9.5)	.015 (0.4) +/- .003 (0.07)	1	250	B30-R4400-WT
i3300, BBP33	Fig. 20	B33D-1000-2-345BK	B-345	Blk. 2/0 to 0.950 dia	0.450 (11.4) - 0.950 (24.1)	1.000 (25.4)	0.500 (12.7)	.017 (0.4) +/- .004 (0.1)	1	250	B30-R4400-WT
i3300, BBP33	Fig. 20	B33D-1500-2-345BK	B-345	Blk. N/A	0.750 (19.1) - 1.400 (35.6)	1.500 (38.1)	0.750 (19.1)	.024 (0.6) +/- .004 (0.1)	1	150	B30-R4400-WT

Print double-sided wire sleeves with the BradyPrinter i3300 Industrial Label Printer

You can quickly create double-sided sleeve by using "B33D-" parts and Brady Workstation's two-sided print feature.

Once the first side of your print job is complete, the software prompts you to cut the media and re-insert it for a second print pass.



*All supplies listed are compatible with the following printers unless otherwise noted: BradyPrinter S3000, S3100, i3300, BBP®30, BBP®31, BBP®33, BBP®35 and BBP®37 printers.

PermaSleeve® HX Polyolefin Wire Markers (B-7642)

Military / industrial 2:1 heat-shrinkable sleeves are flame-retardant and high-temperature rated but not as high-temperature as B-345 HT sleeves.

Meets specifications:

- SAE-AS23053/5
- SAE-AS-81531

Tested per:

- ASTM E162 and ASTM E662
- MIL-STD-202

Service temp: -40° F to 248° F (short burst max temp: 5 min at 464° F, 24 hrs at 320° F)

Agency approval: **RoHS**

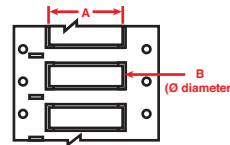
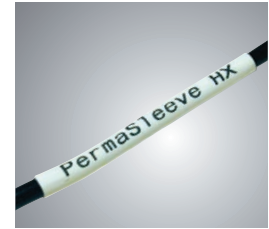

Figure 20



Fits Printers	Figure	Catalog #	Material	For Wire Gauge (approx.)	Range For Wire Diameters Inch (mm)	Supplied Diameter B Inch (mm)	Recovered Diameter Inch (mm)	Recovered Wall Thickness Inch (mm)	Sleeves Per Row	Per Roll	Rec. Ribbon
2:1 Shrink ratio, single-side printable, 2 inch sleeve width (dimension A):											
i3300, BBP33	Fig. 20	B33-94-2-7642	B-7642	Wt. 24 to 20	0.047 (1.2) - 0.080 (2.0)	0.094 (2.4)	0.047 (1.2)	.020 (0.5) +/- .003 (0.07)	1	500	B30-R4300
i3300, BBP33	Fig. 20	B33-125-2-7642	B-7642	Wt. 20 to 16	0.062 (1.6) - 0.110 (2.8)	0.125 (3.2)	0.063 (1.6)	.020 (0.5) +/- .003 (0.07)	1	500	B30-R4300
i3300, BBP33	Fig. 20	B33-187-2-7642	B-7642	Wt. 16 to 10	0.094 (2.4) - 0.151 (3.8)	0.187 (4.8)	0.094 (2.4)	.020 (0.5) +/- .003 (0.07)	1	450	B30-R4300
i3300, BBP33	Fig. 20	B33-250-2-7642	B-7642	Wt. 12 to 8	0.125 (3.2) - 0.215 (5.5)	0.250 (6.4)	0.126 (3.2)	.025 (0.6) +/- .003 (0.07)	1	400	B30-R4300
i3300, BBP33	Fig. 20	B33-375-2-7642	B-7642	Wt. 8 to 4	0.188 (4.8) - 0.320 (8.1)	0.375 (9.5)	0.189 (4.8)	.025 (0.6) +/- .003 (0.07)	1	250	B30-R4300
i3300, BBP33	Fig. 20	B33-500-2-7642	B-7642	Wt. 6 to 1	0.250 (6.4) - 0.450 (11.4)	0.500 (12.7)	0.252 (6.4)	.025 (0.6) +/- .003 (0.07)	1	225	B30-R4300
i3300, BBP33	Fig. 20	B33-750-2-7642	B-7642	Wt. 2 to 4/0	0.375 (9.5) - 0.700 (17.8)	0.750 (19.0)	0.374 (9.5)	.030 (0.8) +/- .003 (0.07)	1	150	B30-R4300
i3300, BBP33	Fig. 20	B33-1000-2-7642	B-7642	Wt. 2/0 to 0.950 dia	0.450 (11.4) - 0.950 (24.1)	1.000 (25.4)	0.500 (12.7)	.035 (0.9) +/- .005 (0.1)	1	150	B30-R4300
i3300, BBP33	Fig. 20	B33-1500-2-7642	B-7642	Wt. N/A	0.750 (19.0) - 1.400 (35.6)	1.500 (38.1)	0.752 (19.1)	.040 (1.0) +/- .006 (0.2)	1	50	B30-R4300
i3300, BBP33	Fig. 20	B33-2000-2-7642	B-7642	Wt. N/A	1.000 (25.4) - 1.900 (48.3)	2.000 (50.8)	1.000 (25.4)	.045 (1.1) +/- .007 (0.2)	1	50	B30-R4300
2:1 Shrink ratio, double-side printable, 2 inch sleeve width (dimension A):											
i3300, BBP33	Fig. 20	B33D-94-2-7642	B-7642	Wt. 24 to 20	0.047 (1.2) - 0.080 (2.0)	0.094 (2.4)	0.047 (1.2)	.020 (0.5) +/- .003 (0.07)	1	500	B30-R4300
i3300, BBP33	Fig. 20	B33D-125-2-7642	B-7642	Wt. 20 to 16	0.062 (1.6) - 0.110 (2.8)	0.125 (3.2)	0.063 (1.6)	.020 (0.5) +/- .003 (0.07)	1	500	B30-R4300
i3300, BBP33	Fig. 20	B33D-187-2-7642	B-7642	Wt. 16 to 10	0.094 (2.4) - 0.151 (3.8)	0.187 (4.8)	0.094 (2.4)	.020 (0.5) +/- .003 (0.07)	1	450	B30-R4300
i3300, BBP33	Fig. 20	B33D-250-2-7642	B-7642	Wt. 12 to 8	0.125 (3.2) - 0.215 (5.5)	0.250 (6.4)	0.126 (3.2)	.025 (0.6) +/- .003 (0.07)	1	400	B30-R4300
i3300, BBP33	Fig. 20	B33D-375-2-7642	B-7642	Wt. 8 to 4	0.188 (4.8) - 0.320 (8.1)	0.375 (9.5)	0.189 (4.8)	.025 (0.6) +/- .003 (0.07)	1	250	B30-R4300
i3300, BBP33	Fig. 20	B33D-500-2-7642	B-7642	Wt. 6 to 1	0.250 (6.4) - 0.450 (11.4)	0.500 (12.7)	0.252 (6.4)	.025 (0.6) +/- .003 (0.07)	1	225	B30-R4300
i3300, BBP33	Fig. 20	B33D-750-2-7642	B-7642	Wt. 2 to 4/0	0.375 (9.5) - 0.700 (17.8)	0.750 (19.0)	0.374 (9.5)	.030 (0.8) +/- .003 (0.07)	1	150	B30-R4300
i3300, BBP33	Fig. 20	B33D-1000-2-7642	B-7642	Wt. 2/0 to 0.950 dia	0.450 (11.4) - 0.950 (24.1)	1.000 (25.4)	0.500 (12.7)	.035 (0.9) +/- .005 (0.1)	1	150	B30-R4300
i3300, BBP33	Fig. 20	B33D-1500-2-7642	B-7642	Wt. N/A	0.750 (19.0) - 1.400 (35.6)	1.500 (38.1)	0.752 (19.1)	.040 (1.0) +/- .006 (0.2)	1	50	B30-R4300
i3300, BBP33	Fig. 20	B33D-2000-2-7642	B-7642	Wt. N/A	1.000 (25.4) - 1.900 (48.3)	2.000 (50.8)	1.000 (25.4)	.045 (1.1) +/- .007 (0.2)	1	50	B30-R4300

PermaSleeve® LSZH Low-Smoke Zero-Halogen Polyolefin Wire Markers (B-7641)

Low-halogen, 2:1 heat-shrinkable sleeves offer outstanding fire safety properties and minimal smoke emission.

Meets specifications:

- SAE-AS-81531
- EN45545-2

Tested per:

- ASTM E162 and ASTM E662
- MIL-STD-202

Service temp: -22° F to 221° F

Agency approval: **RoHS**

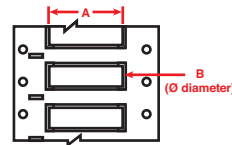

Figure 20



Fits Printers	Figure	Catalog #	Material	Range For Wire Diameters Inch (mm)	Supplied Diameter B Inch (mm)	Recovered Diameter Inch (mm)	Recovered Wall Thickness Inch (mm)	Sleeves Per Row	Per Roll	Rec. Ribbon
2:1 Shrink ratio double-side printable, 2 inch sleeve width (dimension A):										
i3300, BBP33	Fig. 20	B33D-94-2-7641	B-7641	Wt. 0.047 (1.2) - 0.080 (2.0)	0.094 (2.4)	0.047 (1.2)	.020 (0.5) +/- .003 (0.07)	1	1000	B30-R6000
i3300, BBP33	Fig. 20	B33D-125-2-7641	B-7641	Wt. 0.062 (1.6) - 0.110 (2.8)	0.125 (3.2)	0.063 (1.6)	.020 (0.5) +/- .003 (0.07)	1	1000	B30-R6000
i3300, BBP33	Fig. 20	B33D-187-2-7641	B-7641	Wt. 0.094 (2.4) - 0.151 (3.8)	0.187 (4.8)	0.094 (2.4)	.020 (0.5) +/- .003 (0.07)	1	450	B30-R6000
i3300, BBP33	Fig. 20	B33D-250-2-7641	B-7641	Wt. 0.125 (3.2) - 0.215 (5.5)	0.250 (6.4)	0.126 (3.2)	.025 (0.6) +/- .003 (0.07)	1	500	B30-R6000
i3300, BBP33	Fig. 20	B33D-375-2-7641	B-7641	Wt. 0.188 (4.8) - 0.320 (8.1)	0.375 (9.5)	0.189 (4.8)	.025 (0.6) +/- .003 (0.07)	1	500	B30-R6000
i3300, BBP33	Fig. 20	B33D-500-2-7641	B-7641	Wt. 0.250 (6.4) - 0.450 (11.4)	0.500 (12.7)	0.252 (6.4)	.025 (0.6) +/- .003 (0.07)	1	225	B30-R6000
i3300, BBP33	Fig. 20	B33D-750-2-7641	B-7641	Wt. 0.375 (9.5) - 0.700 (17.8)	0.750 (19.0)	0.374 (9.5)	.030 (0.8) +/- .003 (0.07)	1	150	B30-R6000
i3300, BBP33	Fig. 20	B33D-1000-2-7641	B-7641	Wt. 0.450 (11.4) - 0.950 (24.1)	1.000 (25.4)	0.500 (12.7)	.035 (0.9) +/- .005 (0.1)	1	150	B30-R6000
i3300, BBP33	Fig. 20	B33D-1500-2-7641	B-7641	Wt. 0.750 (19.0) - 1.400 (35.6)	1.500 (38.1)	0.752 (19.1)	.040 (1.0) +/- .006 (0.2)	1	50	B30-R6000
i3300, BBP33	Fig. 20	B33D-94-2-7641Y	B-7641	Ylw. 0.047 (1.2) - 0.080 (2.0)	0.094 (2.4)	0.047 (1.2)	.020 (0.5) +/- .003 (0.07)	1	1000	B30-R6000
i3300, BBP33	Fig. 20	B33D-125-2-7641Y	B-7641	Ylw. 0.062 (1.6) - 0.110 (2.8)	0.125 (3.2)	0.063 (1.6)	.020 (0.5) +/- .003 (0.07)	1	1000	B30-R6000
i3300, BBP33	Fig. 20	B33D-187-2-7641Y	B-7641	Ylw. 0.094 (2.4) - 0.151 (3.8)	0.187 (4.8)	0.094 (2.4)	.020 (0.5) +/- .003 (0.07)	1	450	B30-R6000
i3300, BBP33	Fig. 20	B33D-250-2-7641Y	B-7641	Ylw. 0.125 (3.2) - 0.215 (5.5)	0.250 (6.4)	0.126 (3.2)	.025 (0.6) +/- .003 (0.07)	1	500	B30-R6000
i3300, BBP33	Fig. 20	B33D-375-2-7641Y	B-7641	Ylw. 0.188 (4.8) - 0.320 (8.1)	0.375 (9.5)	0.189 (4.8)	.025 (0.6) +/- .003 (0.07)	1	500	B30-R6000
i3300, BBP33	Fig. 20	B33D-500-2-7641Y	B-7641	Ylw. 0.250 (6.4) - 0.450 (11.4)	0.500 (12.7)	0.252 (6.4)	.025 (0.6) +/- .003 (0.07)	1	225	B30-R6000
i3300, BBP33	Fig. 20	B33D-750-2-7641Y	B-7641	Ylw. 0.375 (9.5) - 0.700 (17.8)	0.750 (19.0)	0.374 (9.5)	.030 (0.8) +/- .003 (0.07)	1	150	B30-R6000
i3300, BBP33	Fig. 20	B33D-1000-2-7641Y	B-7641	Ylw. 0.450 (11.4) - 0.950 (24.1)	1.000 (25.4)	0.500 (12.7)	.035 (0.9) +/- .005 (0.1)	1	150	B30-R6000
i3300, BBP33	Fig. 20	B33D-1500-2-7641Y	B-7641	Ylw. 0.750 (19.0) - 1.400 (35.6)	1.500 (38.1)	0.752 (19.1)	.040 (1.0) +/- .006 (0.2)	1	50	B30-R6000

*All supplies listed are compatible with the following printers unless otherwise noted: BradyPrinter S3000, S3100, i3300, BBP®30, BBP®31, BBP®33, BBP®35 and BBP®37 printers.

B30- and B33-Series Materials

BradyID.com/s36

PermaSleeve® FR Fluid-Resistant Wire Markers (B-344)

Military / industrial grade 3:1 heat-shrinkable sleeves are specifically designed for applications with exposure to fuels, lubricants and harsh chemicals such as in the installation of hydrogen fuel cells for aerospace. These sleeves are resistant to harsh chemicals including, JP8 Jet Fuel, Skydrol and DOT 3 brake fluid.

Meets specification:

- SAE-AS23053/5

Tested per:

- ASTM E162
- ASTM E662
- MIL-STD-202G

Service temp: -94° F to 275° F
Agency approvals: **RoHS**

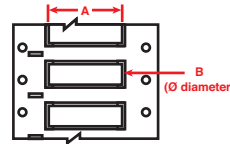

Figure 20



Benchtop Printers

B30 / B33 Series

Fits Printers	Figure	Catalog #	Material	For Wire Gauge (approx.)	Range For Wire Diameters Inch (mm)	Supplied Diameter B Inch (mm)	Recovered Diameter Inch (mm)	Recovered Wall Thickness Inch (mm)	Sleeves Per Row	Sleeves Per Roll	Rec. Ribbon	
3:1 Shrink ratio, double-side printable, 2 inch sleeve width (dimension A):												
i3300, BBP33	Fig. 20	* B33D-94-2-344	B-344	Wt.	28 to 20	0.023 (0.6) - 0.080 (2.0)	0.094 (2.4)	0.024 (0.6)	0.024 (0.6) +/- 0.003 (0.1)	1	1000	B30-R6600
i3300, BBP33	Fig. 20	* B33D-125-2-344	B-344	Wt.	22 to 16	0.046 (1.2) - 0.111 (2.8)	0.125 (3.1)	0.047 (1.2)	0.020 (0.5) +/- 0.003 (0.1)	1	1000	B30-R6600
i3300, BBP33	Fig. 20	* B33D-187-2-344	B-344	Wt.	20 to 10	0.062 (1.6) - 0.15 (3.81)	0.187 (4.8)	0.062 (1.6)	0.020 (0.5) +/- 0.003 (0.1)	1	750	B30-R6600
i3300, BBP33	Fig. 20	* B33D-250-2-344	B-344	Wt.	16 to 8	0.094 (2.4) - 0.215 (5.5)	0.250 (6.35)	0.093 (2.4)	0.025 (0.6) +/- 0.003 (0.1)	1	500	B30-R6600
i3300, BBP33	Fig. 20	* B33D-375-2-344	B-344	Wt.	12 to 4	0.125 (3.2) - 0.320 (8.1)	0.375 (9.5)	0.125 (3.2)	0.025 (0.6) +/- 0.003 (0.1)	1	500	B30-R6600
i3300, BBP33	Fig. 20	* B33D-500-2-344	B-344	Wt.	8 to 1	0.187 (4.8) - 0.450 (11.4)	0.500 (12.7)	0.119 (3.0)	0.025 (0.6) +/- 0.003 (0.1)	1	350	B30-R6600
i3300, BBP33	Fig. 20	* B33D-750-2-344	B-344	Wt.	6 to 4/0	0.250 (6.4) - 0.700 (17.8)	0.750 (19.05)	0.250 (6.35)	0.025 (0.6) +/- 0.003 (0.1)	1	250	B30-R6600
i3300, BBP33	Fig. 20	* B33D-1000-2-344	B-344	Wt.	2 to 0.950 dia	0.333 (8.5) - 0.950 (24.1)	1.000 (25.4)	0.375 (9.5)	0.036 (0.9) +/- 0.003 (0.1)	1	250	B30-R6600
i3300, BBP33	Fig. 20	* B33D-1500-2-344	B-344	Wt.	n/a	0.500 (12.7) - 1.400 (35.6)	1.500 (38.1)	0.500 (12.7)	0.035 (0.9) +/- 0.003 (0.1)	1	150	B30-R6600
i3300, BBP33	Fig. 20	* B33D-94-2-344YL	B-344	Ylw.	28 to 20	0.023 (0.6) - 0.080 (2.0)	0.094 (2.4)	0.024 (0.6)	0.024 (0.6) +/- 0.003 (0.1)	1	1000	B30-R6600
i3300, BBP33	Fig. 20	* B33D-125-2-344YL	B-344	Ylw.	22 to 16	0.046 (1.2) - 0.111 (2.8)	0.125 (3.1)	0.047 (1.2)	0.020 (0.5) +/- 0.003 (0.1)	1	1000	B30-R6600
i3300, BBP33	Fig. 20	* B33D-187-2-344YL	B-344	Ylw.	20 to 10	0.062 (1.6) - 0.15 (3.81)	0.187 (4.8)	0.062 (1.6)	0.020 (0.5) +/- 0.003 (0.1)	1	750	B30-R6600
i3300, BBP33	Fig. 20	* B33D-250-2-344YL	B-344	Ylw.	16 to 8	0.094 (2.4) - 0.215 (5.5)	0.250 (6.35)	0.093 (2.4)	0.025 (0.6) +/- 0.003 (0.1)	1	500	B30-R6600
i3300, BBP33	Fig. 20	* B33D-375-2-344YL	B-344	Ylw.	12 to 4	0.125 (3.2) - 0.320 (8.1)	0.375 (9.5)	0.125 (3.2)	0.025 (0.6) +/- 0.003 (0.1)	1	500	B30-R6600
i3300, BBP33	Fig. 20	* B33D-500-2-344YL	B-344	Ylw.	8 to 1	0.187 (4.8) - 0.450 (11.4)	0.500 (12.7)	0.119 (3.0)	0.025 (0.6) +/- 0.003 (0.1)	1	350	B30-R6600
i3300, BBP33	Fig. 20	* B33D-750-2-344YL	B-344	Ylw.	6 to 4/0	0.250 (6.4) - 0.700 (17.8)	0.750 (19.05)	0.250 (6.35)	0.025 (0.6) +/- 0.003 (0.1)	1	250	B30-R6600
i3300, BBP33	Fig. 20	* B33D-1000-2-344YL	B-344	Ylw.	2 to 0.950 dia	0.333 (8.5) - 0.950 (24.1)	1.000 (25.4)	0.375 (9.5)	0.036 (0.9) +/- 0.003 (0.1)	1	250	B30-R6600
i3300, BBP33	Fig. 20	* B33D-1500-2-344YL	B-344	Ylw.	n/a	0.500 (12.7) - 1.400 (35.6)	1.500 (38.1)	0.500 (12.7)	0.035 (0.9) +/- 0.003 (0.1)	1	150	B30-R6600
i3300, BBP33	Fig. 20	* B33D-94-2-344BK	B-344	Bk.	28 to 20	0.023 (0.6) - 0.080 (2.0)	0.094 (2.4)	0.024 (0.6)	0.024 (0.6) +/- 0.003 (0.1)	1	1000	B30-R6700-WT
i3300, BBP33	Fig. 20	* B33D-125-2-344BK	B-344	Bk.	22 to 16	0.046 (1.2) - 0.111 (2.8)	0.125 (3.1)	0.047 (1.2)	0.020 (0.5) +/- 0.003 (0.1)	1	1000	B30-R6700-WT
i3300, BBP33	Fig. 20	* B33D-187-2-344BK	B-344	Bk.	20 to 10	0.062 (1.6) - 0.15 (3.81)	0.187 (4.8)	0.062 (1.6)	0.020 (0.5) +/- 0.003 (0.1)	1	750	B30-R6700-WT
i3300, BBP33	Fig. 20	* B33D-250-2-344BK	B-344	Bk.	16 to 8	0.094 (2.4) - 0.215 (5.5)	0.250 (6.35)	0.093 (2.4)	0.025 (0.6) +/- 0.003 (0.1)	1	500	B30-R6700-WT
i3300, BBP33	Fig. 20	* B33D-375-2-344BK	B-344	Bk.	12 to 4	0.125 (3.2) - 0.320 (8.1)	0.375 (9.5)	0.125 (3.2)	0.025 (0.6) +/- 0.003 (0.1)	1	500	B30-R6700-WT
i3300, BBP33	Fig. 20	* B33D-500-2-344BK	B-344	Bk.	8 to 1	0.187 (4.8) - 0.450 (11.4)	0.500 (12.7)	0.119 (3.0)	0.025 (0.6) +/- 0.003 (0.1)	1	350	B30-R6700-WT
i3300, BBP33	Fig. 20	* B33D-750-2-344BK	B-344	Bk.	6 to 4/0	0.250 (6.4) - 0.700 (17.8)	0.750 (19.05)	0.250 (6.35)	0.025 (0.6) +/- 0.003 (0.1)	1	250	B30-R6700-WT
i3300, BBP33	Fig. 20	* B33D-1000-2-344BK	B-344	Bk.	2 to 0.950 dia	0.333 (8.5) - 0.950 (24.1)	1.000 (25.4)	0.375 (9.5)	0.036 (0.9) +/- 0.003 (0.1)	1	250	B30-R6700-WT
i3300, BBP33	Fig. 20	* B33D-1500-2-344BK	B-344	Bk.	n/a	0.500 (12.7) - 1.400 (35.6)	1.500 (38.1)	0.500 (12.7)	0.035 (0.9) +/- 0.003 (0.1)	1	150	B30-R6700-WT

* **WARNING:** Cancer www.P65Warnings.ca.gov

*All supplies listed are compatible with the following printers unless otherwise noted: BradyPrinter S3000, S3100, i3300, BBP®30, BBP®31, BBP®33, BBP®35 and BBP®37 printers.

Color Polyester Labels (B-494)

- Adding color to labels reduces errors, increase efficiency and differentiates your lab samples
- Color printed below the label surface withstands the harshest lab environments, including liquid nitrogen, hot water baths and more
- Labels are resistant to common lab chemicals, like ethanol and xylene, when printed with the R6400 series ribbon

Service temp: -320° F to 70° F
Agency approvals: **RoHS**

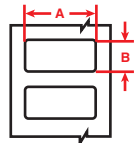

Figure 2

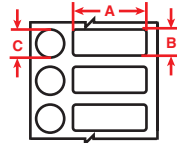

Figure 24

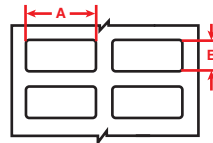

Figure 25



Note: Label dimensions include the color area.

Fits Printers	Figure	Catalog #	B#	Color	Label Width A Inch (mm)	Label Height B Inch (mm)	Vial Top Dia. C Inch (mm)	Labels Per Row	Labels Per Roll	Rec. Ribbon
i3300, BBP33	Fig. 25	B33-152-494-BL	BBP33	Lt. Blue	1.000 (25.4)	0.375 (9.5)	-	2	1500	B30-R6400
i3300, BBP33	Fig. 24	B33-250-494-BL	BBP33	Lt. Blue	1.000 (25.4)	0.500 (12.7)	0.375 (9.5) dia.	1	1500	B30-R6400
i3300, BBP33	Fig. 2	B33-179-494-BL	BBP33	Lt. Blue	1.000 (25.4)	1.000 (25.4)	-	1	1500	B30-R6400
i3300, BBP33	Fig. 25	B33-152-494-GN	BBP33	Green	1.000 (25.4)	0.375 (9.5)	-	2	1500	B30-R6400
i3300, BBP33	Fig. 24	B33-250-494-GN	BBP33	Green	1.000 (25.4)	0.500 (12.7)	0.375 (9.5) dia.	1	1500	B30-R6400
i3300, BBP33	Fig. 2	B33-179-494-GN	BBP33	Green	1.000 (25.4)	1.000 (25.4)	-	1	1500	B30-R6400
i3300, BBP33	Fig. 25	B33-152-494-OR	BBP33	Orange	1.000 (25.4)	0.375 (9.5)	-	2	1500	B30-R6400
i3300, BBP33	Fig. 24	B33-250-494-OR	BBP33	Orange	1.000 (25.4)	0.500 (12.7)	0.375 (9.5) dia.	1	1500	B30-R6400
i3300, BBP33	Fig. 2	B33-179-494-OR	BBP33	Orange	1.000 (25.4)	1.000 (25.4)	-	1	1500	B30-R6400
i3300, BBP33	Fig. 25	B33-152-494-PK	BBP33	Pink	1.000 (25.4)	0.375 (9.5)	-	2	1500	B30-R6400
i3300, BBP33	Fig. 24	B33-250-494-PK	BBP33	Pink	1.000 (25.4)	0.500 (12.7)	0.375 (9.5) dia.	1	1500	B30-R6400
i3300, BBP33	Fig. 2	B33-179-494-PK	BBP33	Pink	1.000 (25.4)	1.000 (25.4)	-	1	1500	B30-R6400
i3300, BBP33	Fig. 25	B33-152-494-RD	BBP33	Red	1.000 (25.4)	0.375 (9.5)	-	2	1500	B30-R6400
i3300, BBP33	Fig. 24	B33-250-494-RD	BBP33	Red	1.000 (25.4)	0.500 (12.7)	0.375 (9.5) dia.	1	1500	B30-R6400
i3300, BBP33	Fig. 2	B33-179-494-RD	BBP33	Red	1.000 (25.4)	1.000 (25.4)	-	1	1500	B30-R6400
i3300, BBP33	Fig. 25	B33-152-494-YL	BBP33	Yellow	1.000 (25.4)	0.375 (9.5)	-	2	1500	B30-R6400
i3300, BBP33	Fig. 24	B33-250-494-YL	BBP33	Yellow	1.000 (25.4)	0.500 (12.7)	0.375 (9.5) dia.	1	1500	B30-R6400
i3300, BBP33	Fig. 2	B33-179-494-YL	BBP33	Yellow	1.000 (25.4)	1.000 (25.4)	-	1	1500	B30-R6400

Sterilization Indicating Labels (B-7425-AC)

- Pre-printed STERILIZED header indicates steam sterilization when autoclaved at 250.7° F (121.5° C) for 10 minutes
- Labels withstand temperature ranges from -320° F to 248° F (-196° C to 121° C)
- For use in LN2, freezers, autoclave and hot water baths
- Chemical resistance to ethanol, DMSO, IPS, short-term xylene, 10% formalin, 50% acetic acid and toluene

Service temp: -112° F to 158° F
Agency approvals: **RoHS**

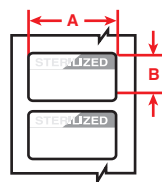

Figure 81



Note: Label dimensions include the STERILIZED indicating area.

Fits Printers	Figure	Catalog #	B#	Color	Label Width A Inch (mm)	Label Height B Inch (mm)	Labels Per Row	Labels Per Roll	Rec. Ribbon
i3300, BBP33	Fig. 81	B33-235-7425-AC	B-7425-AC	White	1.500 (38.1)	1.000 (25.4)	1	1250	B30-R4300
i3300, BBP33	Fig. 81	B33-137-7425-AC	B-7425-AC	White	2.000 (50.8)	1.000 (25.4)	1	1500	B30-R4300

*All supplies listed are compatible with the following printers unless otherwise noted:
BradyPrinter S3000, S3100, i3300, BBP[®]30, BBP[®]31, BBP[®]33, BBP[®]35 and BBP[®]37 printers.

B30- and B33-Series Materials

BradyID.com/s36

Cryogenic Tube and Vial Labels (B-461, B-490, B-492 and B-7425)

FreezerBondz™ labels can be applied to room temperature or already frozen samples, with a small overlap. The label remains legible and will stick to the tube during processing, even when immersed in liquid or vapor-phase nitrogen and ultra-low temperature freezer storage.

- B-461 Self-Laminating Polyester: Ultra-thin label with clear overlamine tail that protects print and allows liquid levels to be visible
- B-490 Polyester: Adhere to already frozen tubes and vials when wrapped around itself by at least 0.125 inch
- B-492 Polyester: Ultra-thin label for frosted, frozen or room temperature vials, tubes and canes. Superior chemical and abrasion resistance
- B-7425 Polypropylene: Ideal for labeling dry, room temperature specimen containers. Material withstands temperature ranges from -320° F to 248° F (-196° C to 121° C). Chemical resistance to ethanol, DMSO, IPS, short-term xylene, 10% formalin, 50% acetic acid and toluene

B-461: Service temp: -321° F to 230° F Agency approvals: RoHS
 B-490: Service temp: -320° F to 366° F Agency approvals: RoHS
 B-492: Service temp: -320° F to 230° F Agency approvals: RoHS
 B-7425: Service temp: -112° F to 158° F Agency approvals: RoHS

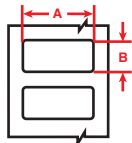

Figure 2

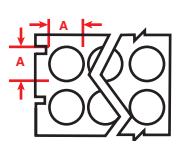

Figure 5

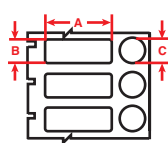

Figure 7

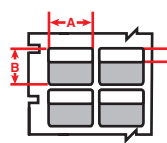

Figure 14c

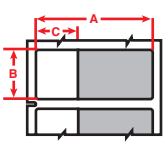

Figure 15c

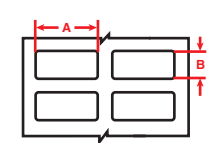

Figure 25a

Fits Printers	Figure	Catalog #	B#	Color	Label Width A Inch (mm)	Label Height B Inch (mm)	Print-On Height C Inch (mm)	Labels Per Row	Labels Per Roll	Rec. Ribbon
Self-Laminating Polyester (B-461):										
i3300, BBP33	Fig. 15c	B33-127-461	B-461	White	0.500 (12.7)	2.200 (55.9)	0.750 (19.1)	1	1500	B30-R4300
i3300, BBP33	Fig. 15c	B33-133-461	B-461	White	0.600 (15.2)	1.625 (41.3)	1.000 (25.4)	1	1500	B30-R4300
i3300, BBP33	Fig. 14c	B33-139-461	B-461	White	1.000 (25.4)	5.250 (133.4)	1.500 (38.1)	2	650	B30-R4300
i3300, BBP33	Fig. 15c	B33-123-461	B-461	White	1.800 (45.7)	0.375 (9.5)	0.750 (19.1)	1	1500	B30-R4300
i3300, BBP33	Fig. 15c	B33-122-461	B-461	White	1.800 (45.7)	0.500 (12.7)	0.750 (19.1)	1	1500	B30-R4300
i3300, BBP33	Fig. 14c	B33-276-461	B-461	White	2.625 (66.7)	1.000 (25.4)	1.000 (25.4)	1	1500	B30-R4300
i3300, BBP33	Fig. 15c	B33-134-461	B-461	White	3.500 (88.9)	1.500 (38.1)	1.250 (31.8)	1	1000	B30-R4300
i3300, BBP33	Fig. 15c	B33-153-461	B-461	White	0.600 (15.2)	2.625 (66.7)	1.000 (25.4)	1	1500	B30-R4300
i3300, BBP33	Fig. 15c	B33-183-461	B-461	White	1.750 (44.4)	1.000 (25.4)	1.000 (25.4)	1	2000	B30-R4300
Polyester (B-490):										
i3300, BBP33	Fig. 5	B33-144-490	B-490	White	0.500 (12.7) dia.	-	-	3	2500	B30-R4300
i3300, BBP33	Fig. 2	B33-68-490	B-490	White	0.500 (12.7)	0.750 (19.1)	-	4	2500	B30-R4300
i3300, BBP33	Fig. 2	B33-125-490	B-490	White	0.900 (22.9)	0.500 (12.7)	-	1	1650	B30-R4300
i3300, BBP33	Fig. 7	B33-126-490	B-490	White	0.900 (22.9)	0.500 (12.7)	0.500 (12.7) dia.	1	2500 sets	B30-R4300
i3300, BBP33	Fig. 2	B33-154-490	B-490	White	1.250 (31.8)	0.375 (9.5)	-	1	1500	B30-R4300
i3300, BBP33	Fig. 2	B33-155-490	B-490	White	1.625 (41.3)	0.600 (15.2)	-	1	1500	B30-R4300
i3300, BBP33	Fig. 2	B33-156-490	B-490	White	1.900 (48.2)	1.000 (25.4)	-	1	1500	B30-R4300
i3300, BBP33	Fig. 2	B33-157-490	B-490	White	2.200 (55.9)	1.500 (38.1)	-	1	1000	B30-R4300
i3300, BBP33	Fig. 2	B33-158-490	B-490	White	3.750 (95.3)	1.750 (44.4)	-	1	1100	B30-R4300
Polyester (B-492):										
i3300, BBP33	Fig. 5	B33-143-492	B-492	White	0.375 (9.5) dia.	-	-	4	1500	B30-R6400
i3300, BBP33	Fig. 5	B33-144-492	B-492	White	0.500 (12.7) dia.	-	-	3	1500	B30-R6400
i3300, BBP33	Fig. 7	B33-182-492	B-492	White	0.500 (12.7)	1.000 (25.4)	0.440 (11.17) dia.	1	1500 sets	B30-R6400
i3300, BBP33	Fig. 2	B33-180-492	B-492	White	0.900 (22.9)	1.000 (25.4)	-	1	1500	B30-R6400
i3300, BBP33	Fig. 25a	B33-152-492	B-492	White	1.000 (25.4)	0.375 (9.5)	-	2	2500	B30-R6400
i3300, BBP33	Fig. 7	B33-163-492	B-492	White	1.000 (25.4)	0.375 (9.5)	0.375 (9.5) dia.	1	1500 sets	B30-R6400
i3300, BBP33	Fig. 7	B33-181-492	B-492	White	1.000 (25.4)	0.500 (12.7)	0.500 (12.7) dia.	1	1500 sets	B30-R6400
i3300, BBP33	Fig. 2	B33-59-492	B-492	White	1.000 (25.4)	0.500 (12.7)	-	1	5000	B30-R6400
i3300, BBP33	Fig. 2	B33-179-492	B-492	White	1.000 (25.4)	1.000 (25.4)	-	1	1900	B30-R6400
i3300, BBP33	Fig. 2	B33-155-492	B-492	White	1.625 (41.3)	0.600 (15.2)	-	1	1500	B30-R6400
i3300, BBP33	Fig. 7	B33-190-492	B-492	White	1.625 (41.3)	0.600 (15.2)	0.375 (9.5) dia.	1	1500 sets	B30-R6400
i3300, BBP33	Fig. 2	B33-156-492	B-492	White	1.900 (48.3)	1.000 (25.4)	-	1	1500	B30-R6400
Polypropylene (B-7425):										
i3300, BBP33	Fig. 2	B33-257-7425	B-7425	White	0.825 (21.0)	0.250 (6.4)	-	1	1500	B30-R4300
i3300, BBP33	Fig. 25a	B33-152-7425	B-7425	White	1.000 (25.4)	0.375 (9.5)	-	2	2000	B30-R4300
i3300, BBP33	Fig. 2	B33-59-7425	B-7425	White	1.000 (25.4)	0.500 (12.7)	-	1	2000	B30-R4300
i3300, BBP33	Fig. 25a	B33-88-7425	B-7425	White	1.000 (25.4)	0.750 (19.1)	-	2	2000	B30-R4300
i3300, BBP33	Fig. 2	B33-256-7425	B-7425	White	1.300 (33.0)	0.600 (15.2)	-	1	1500	B30-R4300
i3300, BBP33	Fig. 25a	B33-37-7425	B-7425	White	1.500 (38.1)	0.500 (12.7)	-	2	1500	B30-R4300

*All supplies listed are compatible with the following printers unless otherwise noted: BradyPrinter S3000, S3100, i3300, BBP®30, BBP®31, BBP®33, BBP®35 and BBP®37 printers.

Centrifuge and PCR Tube Labels (B-499 and B-7425)

Designed with ultra-thin material that prevents vials from jamming in centrifuges or racks, these labels withstand harsh temperatures and chemicals without falling off, fading or smearing.

- B-499 Nylon Cloth: White nylon cloth for easy handling and conformability
- B-7425 Polypropylene: Moderate chemical resistance, ideal for labeling dry, room temperature specimen containers that withstand temperature ranges from -320° F to 248° F (-196° C to 121° C). Chemical resistance to ethanol, DMSO, IPS, short-term xylene, 10% formalin, 50% acetic acid and toluene

B-499: Service temp: -40° F to 194° F Agency approvals: RoHS
 B-7425: Service temp: -112° F to 158° F Agency approvals:

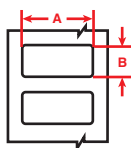

Figure 2

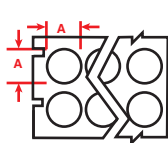

Figure 5

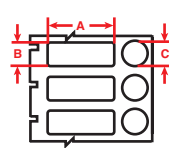

Figure 7

Fits Printers	Figure	Catalog #	B#	Color	Label Width A Inch (mm)	Label Height B Inch (mm)	Vial Top Dia. C Inch (mm)	Labels Per Row	Labels Per Roll	Rec. Ribbon
Nylon Cloth (B-499):										
i3300, BBP33	Fig. 5	B33-143-499	B-499	White	0.375 (9.5) dia.	-	-	4	1500	B30-R6000
i3300, BBP33	Fig. 5	B33-144-499	B-499	White	0.500 (12.7) dia.	-	-	3	1500	B30-R6000
i3300, BBP33	Fig. 7	B33-126-499	B-499	White	0.900 (22.9)	0.500 (12.7)	0.500 (12.7) dia.	1	1500 sets	B30-R6000
Polypropylene (B-7425):										
i3300, BBP33	Fig. 2	B33-257-7425	B-7425	White	0.825 (21.0)	0.250 (6.4)	-	1	1500	B30-R4300
i3300, BBP33	Fig. 2	B33-152-7425	B-7425	White	1.000 (25.4)	0.375 (9.5)	-	2	2000	B30-R4300
i3300, BBP33	Fig. 7	B33-249-7425	B-7425	White	1.000 (25.4)	0.375 (9.5)	0.375 (9.5) dia.	1	1500 sets	B30-R4300
i3300, BBP33	Fig. 2	B33-59-7425	B-7425	White	1.000 (25.4)	0.500 (12.7)	-	1	2000	B30-R4300
i3300, BBP33	Fig. 7	B33-251-7425	B-7425	White	1.000 (25.4)	0.500 (12.7)	0.440 (11.1) dia.	1	1500 sets	B30-R4300
i3300, BBP33	Fig. 2	B33-179-7425	B-7425	White	1.000 (25.4)	1.000 (25.4)	-	1	1500	B30-R4300
i3300, BBP33	Fig. 2	B33-256-7425	B-7425	White	1.300 (33.0)	0.600 (15.2)	-	1	1500	B30-R4300
i3300, BBP33	Fig. 2	B33-37-7425	B-7425	White	1.500 (38.1)	0.500 (12.7)	-	2	1500	B30-R4300
i3300, BBP33	Fig. 2	B33-136-7425	B-7425	White	1.500 (38.1)	0.750 (19.1)	-	1	1500	B30-R4300
i3300, BBP33	Fig. 2	B33-258-7425	B-7425	White	1.500 (38.1)	1.750 (44.5)	-	1	900	B30-R4300
i3300, BBP33	Fig. 2	B33-137-7425	B-7425	White	2.000 (50.8)	1.000 (25.4)	-	1	1500	B30-R4300

Microscope Slide Labels (B-481)

- StainerBondz™ polyester material is designed to identify slides and to resist exposure to harsh chemicals during the slide-staining process
- Performs well in stains such as hematoxylin and eosin
- Extreme chemical resistance withstands the rigors of typical deparaffinization, including ethanol, xylene and H&E staining processes

Service temp: -112° F to 266° F
 Agency approvals:

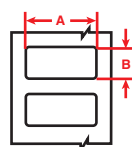

Figure 2

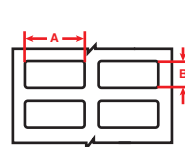

Figure 25



Fits Printers	Figure	Catalog #	B#	Color	Label Width A Inch (mm)	Label Height B Inch (mm)	Labels Per Row	Labels Per Roll	Rec. Ribbon
i3300, BBP33	Fig. 2	B33-195-481	B-481	White	0.900 (22.9)	0.375 (9.5)	1	3000	B30-R6400
i3300, BBP33	Fig. 2	B33-194-481	B-481	White	0.900 (22.9)	0.750 (19.1)	1	2000	B30-R6400
i3300, BBP33	Fig. 25	B33-141-481	B-481	White	0.900 (22.9)	0.900 (22.9)	2	1500	B30-R6400

*All supplies listed are compatible with the following printers unless otherwise noted: BradyPrinter S3000, S3100, i3300, BBP[®]30, BBP[®]31, BBP[®]33, BBP[®]35 and BBP[®]37 printers.

B30- and B33-Series Materials

BradyID.com/s36

Benchtop Printers

B30 / B33 Series

Dissolvable Paper Labels (B-403)

- Designed for temporary applications where easy removal, re-identification or waste reduction are valued
- Ideal for labeling vials, tubes or general glassware, temporary asset tracking, animal housing identification and general use
- Completely dissolves in warm water within 30 seconds, leaving no adhesive residue

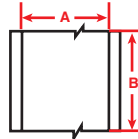

Dissolves within 30 seconds leaving no residue.

Service temp: -40° F to 172° F

Fits Printers	Figure	Catalog #	B#	Color	Label Width A Inch (mm)	Roll Length B Inch (mm)	Labels Per Roll	Rec. Ribbon
All*	Fig. 3	B30C-1125-403-WT	B-403	White	1.125 (28.6)	100 (30.5)	1 (cont.)	B30-R4300
All*	Fig. 3	B30C-2250-403-WT	B-403	White	2.250 (57.15)	100 (30.5)	1 (cont.)	B30-R4300
All*	Fig. 3	B30C-3000-403-WT	B-403	White	3.000 (76.2)	100 (30.5)	1 (cont.)	B30-R4300
All*	Fig. 3	B30C-4000-403-WT	B-403	White	4.000 (101.6)	100 (30.5)	1 (cont.)	B30-R4300

Well and Microplate Labels (B-490, B-499)

- Designed with a short height and long width to fit the necessary information on the plate
- B-490 Polyester: White FreezerBondz label ideal for flat frozen surfaces
- B-499 Nylon Cloth: Thick white nylon cloth with permanent adhesive provides easy handling and conformability
- B-7425 Polypropylene: Moderate chemical resistance, ideal for labeling dry, room temperature specimen containers

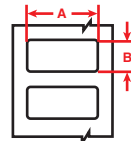

Figure 2

B-490: Service temp: -320° F to 366° F Agency approvals: RoHS
 B-499: Service temp: -40° F to 194° F Agency approvals: RoHS
 B-7425: Service temp: -112° F to 158° F Agency approvals: RoHS

Fits Printers	Figure	Catalog #	B#	Color	Label Width A Inch (mm)	Label Height B Inch (mm)	Labels Per Row	Labels Per Roll	Rec. Ribbon
i3300, BBP33	Fig. 2	B33-151-490	B-490	White	2.000 (50.8)	0.250 (6.4)	1	2500	B30-R4300
i3300, BBP33	Fig. 2	B33-151-499	B-499	White	2.000 (50.8)	0.250 (6.4)	1	1500	B30-R6000
i3300, BBP33	Fig. 2	B33-151-7425	B-499	White	2.000 (50.8)	0.250 (6.4)	1	2000	B30-R4300

Tissue Cassette Labels (B-482)

- White polyester label with superior resistance to tissue processing chemicals and embedding procedures
- Use with the BSP™31 Label Attachment system for tissue cassette identification

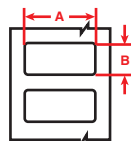

Figure 2



Fits Printers	Figure	Catalog #	B#	Color	Label Width A Inch (mm)	Label Height B Inch (mm)	Labels Per Row	Labels Per Roll	Rec. Ribbon
i3300, BBP33	Fig. 2	B33-199-482	B-482	White	1.050 (26.7)	0.250 (6.4)	1	3000	B30-R6400
i3300, BBP33	Fig. 2	B33-213-482	B-482	White	1.050 (26.7)	0.313 (8)	1	3000	B30-R6400

*All supplies listed are compatible with the following printers unless otherwise noted: BradyPrinter S3000, S3100, i3300, BBP®30, BBP®31, BBP®33, BBP®35 and BBP®37 printers.

B30- and B33-Series Materials

BradyID.com/s36

General Identification for Laboratory Storage, Equipment and Safety Labels (B-499, B-595, B-7569)

- Super-strong adhesives and colors ideal for marking laboratory equipment, containers, hoses and lab storage cabinets, shelves and drawers
- GHS labels available for marking chemicals in the lab and shipment boxes when collaborating with other labs
- Pre-printed sign header labels make your safety and housekeeping reminders stand out and stay put

B-499: Service temp: -40° F to 193° F Agency approvals:
 B-595: Service temp: -40° F to 180° F Agency approvals:
 B-7569: Service temp: -4° F to 167° F

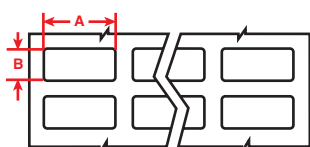
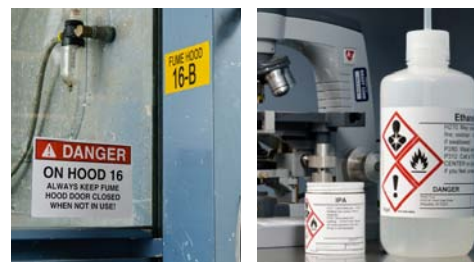

Figure 1

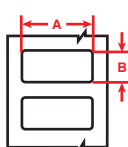

Figure 2

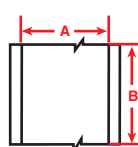

Figure 3

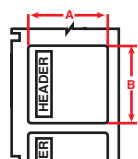

Figure 70

Fits Printers	Figure	Catalog #	B#	Color /Legend	Label Width A Inch (mm)	Label Height B Inch (mm)	Labels Per Row	Labels Per Roll	Rec. Ribbon
Nylon Cloth - Permanent adhesive (B-499):									
i3300, BBP33	Fig. 1	B33-68-499	B-499	White	0.500 (12.7)	0.750 (19.1)	4	1500	B30-R6000
i3300, BBP33	Fig. 1	B33-165-499	B-499	White	0.800 (20.3)	1.437 (36.5)	4	2500	B30-R6000
i3300, BBP33	Fig. 2	B33-125-499	B-499	White	0.900 (22.9)	0.500 (12.7)	1	1500	B30-R6000
i3300, BBP33	Fig. 1	B33-126-499	B-499	White	0.900 (22.9)	0.500 (12.7)	2	1500	B30-R6000
i3300, BBP33	Fig. 2	B33-163-499	B-499	White	1.000 (25.4)	0.375 (9.5)	1	1500	B30-R6000
i3300, BBP33	Fig. 1	B33-152-499	B-499	White	1.000 (25.4)	0.375 (9.5)	2	1500	B30-R6000
i3300, BBP33	Fig. 2	B33-136-499	B-499	White	1.500 (38.1)	0.750 (19.1)	1	1500	B30-R6000
i3300, BBP33	Fig. 2	B33-137-499	B-499	White	2.000 (50.8)	1.000 (25.4)	1	1100	B30-R6000
i3300, BBP33	Fig. 2	B33-125-499	B-499	White	2.000 (50.8)	0.250 (6.4)	1	1500	B30-R6000
Indoor / Outdoor Vinyl (B-595):									
All*	Fig. 3	B30C-500-595-WT	B-595	White	0.500 (12.7)	100 ft. (30.5 m)	-	1 roll (cont.)	B30-R10000
All*	Fig. 3	B30C-1125-595-WT	B-595	White	1.125 (28.6)	100 ft. (30.5 m)	-	1 roll (cont.)	B30-R10000
All*	Fig. 3	B30C-500-595-YL	B-595	Yellow	0.500 (12.7)	100 ft. (30.5 m)	-	1 roll (cont.)	B30-R10000
All*	Fig. 3	B30C-1125-595-YL	B-595	Yellow	1.125 (28.6)	100 ft. (30.5 m)	-	1 roll (cont.)	B30-R10000
All*	Fig. 3	B30C-500-595-RD	B-595	Red	0.500 (12.7)	100 ft. (30.5 m)	-	1 roll (cont.)	B30-R10000-WT
All*	Fig. 3	B30C-1125-595-RD	B-595	Red	1.125 (28.6)	100 ft. (30.5 m)	-	1 roll (cont.)	B30-R10000-WT
All*	Fig. 3	B30C-500-595-BL	B-595	Blue	0.500 (12.7)	100 ft. (30.5 m)	-	1 roll (cont.)	B30-R10000-WT
All*	Fig. 3	B30C-1125-595-BL	B-595	Blue	1.125 (28.6)	100 ft. (30.5 m)	-	1 roll (cont.)	B30-R10000-WT
All*	Fig. 3	B30C-500-595-GN	B-595	Green	0.500 (12.7)	100 ft. (30.5 m)	-	1 roll (cont.)	B30-R10000-WT
All*	Fig. 3	B30C-1125-595-GN	B-595	Green	1.125 (28.6)	100 ft. (30.5 m)	-	1 roll (cont.)	B30-R10000-WT
Pre-Printed Pre-Cut Blank Sign Headers (B-595):									
All*	Fig. 70	B30-241-595-ANSIDA	B-595		2.250 (57.5)	3.000 (76.2)	1	300	B30-R10000
All*	Fig. 70	B30-25-595-ANSIDA	B-595		4.000 (101.6)	6.000 (152.4)	1	175	B30-R10000
All*	Fig. 70	B30-241-595-ANSINO	B-595		2.250 (57.5)	3.000 (76.2)	1	300	B30-R10000
All*	Fig. 70	B30-25-595-ANSINO	B-595		4.000 (101.6)	6.000 (152.4)	1	175	B30-R10000
Pre-Printed GHS / CLP Chemical (B-7569):									
All*	L4B Diamond + Text	B30-260-7569-CLP4B	B-7569		2.170 (55.0)	3.350 (85.0)	1	340	B30-R10000
		B30-261-7569-CLP4B	B-7569		2.950 (75.0)	4.330 (110.0)	1	270	B30-R10000
All*	L4C Diamond + Text	B30-18-7569-CLP4C	B-7569		1.000 (25.4)	3.000 (76.2)	1	1000	B30-R10000

Additional sizes and colors available for: B-595 on page 40; sign headers on page 44; GHS labels on page 42. U.S. Patent No. 5,823,689; 6,570,602 on B-595 vinyl. Additional patents pending.

*All supplies listed are compatible with the following printers unless otherwise noted: BradyPrinter S3000, S3100, i3300, BBP[®]30, BBP[®]31, BBP[®]33, BBP[®]35 and BBP[®]37 printers.

B30-Series Supply Kits

BradyID.com/s36

B30-Series Supply Kits

for BradyPrinter S3000, S3100, i3300, BBP®30, BBP®31, BBP®33, BBP®35 and BBP®37 printers

Get started right and save a little, too, with a Brady supply starter kit. These kits contain the most commonly used labels and ribbons to ensure you have what you need to get going on your projects.

Benchtop Printers

B30 / B33 Series



Basic Supply Starter Kit

Kit includes:

- (1) B30C-4000-595-YL - 4 in. yellow vinyl
- (1) B30C-4000-595-WT - 4 in. white vinyl
- (1) B30C-2250-595-RD - 2.25 in. red vinyl
- (1) B30-R10000 - Black print ribbon
- (1) B30-R10000-WT - White print ribbon

Catalog #	Description
146069	Basic Supply Starter Kit - Small

Printer sold separately.



Gauge Label Supply Kit for BBP37 Printer*

Kit includes:

- (2) B30C-4000-595-WT - 4 in. white vinyl
- (2) B30-R10000-GR-8 - Green / red paneled print ribbon; 8 in. panel length

Catalog #	Description
146070	Gauge Label Supply Kit - Small

*BBP37 printer required to cut gauge label. Printer sold separately.



Arc Flash Supply Kit

Large kit includes:

- (2) B30-25-595-ANSIWA - 4 in. x 6 in. B-595 ANSI warning header
- (1) B30-241-595-ANSIWA - 2.25 in. x 3 in. B-595 ANSI warning header
- (1) B30EP-174-593-WT - 1 in. x 4 in. B-593 white raised panel label
- (1) B30C-2250-595-OR - 2.25 in. B-595 orange vinyl
- (3) B30-R10000 - Black print ribbon

Small kit includes:

- (2) B30-25-595-ANSIWA - 4 in. x 6 in. ANSI warning header
- (1) B30-R10000 - Black print ribbon

Catalog #	Description
142061	Arc Flash Supply Kit - Large
146071	Arc Flash Supply Kit - Small
S3100W-ARC-KIT	BradyPrinter S3100 w/ Large Arc Flash Supply Kit

Printer sold separately unless otherwise noted.



GHS Supply Kit

Large kit includes:

- (1) B30-262-7569-CLP4B - 4 in. x 6 in. four-diamond GHS label
- (2) B30-261-7569-CLP4B - 3 in. x 4 in. four-diamond GHS label
- (1) B30-260-7569-CLP4B - 2 in. x 3 in. four-diamond GHS label
- (3) B30-R10000 - Black print ribbon

Small kit includes:

- (2) B30-262-7569-CLP4B - 4 in. x 6 in. four-diamond GHS label
- (1) B30-R10000 - Black print ribbon

Catalog #	Description
146072	GHS Supply Kit - Large
146073	GHS Supply Kit - Small
S3100W-GHS-KIT	BradyPrinter S3100 w/ Large GHS Supply Kit

Printer sold separately unless otherwise noted.



Safety and Compliance Supply Kit

Kit includes:

- (1) B30-25-595-ANSIDA - 4 in. x 6 in. B-595 ANSI danger header
- (1) B30-25-595-ANSIWA - 4 in. x 6 in. B-595 ANSI warning header
- (1) B30-25-595-ANSICA - 4 in. x 6 in. B-595 ANSI caution header
- (1) B30-25-595-ANSINO - 4 in. x 6 in. B-595 ANSI notice header
- (1) B30C-4000-526 - 4 in. B-526 photoluminescent
- (1) B30-263-595-NFPA - 4 in. x 6 in. B-595 NFPA right to know diamond
- (2) B30-R10000 - Black print ribbon
- (1) B30-R10000-RD - Red print ribbon

Catalog #	Description
142062	Safety Supply Kit - Large
S3100W-SAFE-KIT	BradyPrinter S3100 w/ Safety Supply Kit

Printer sold separately unless otherwise noted.

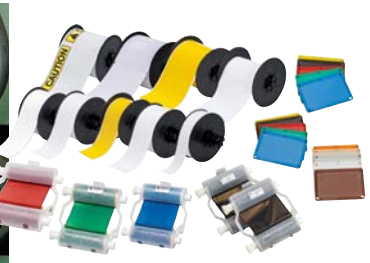

Lean / 5S Visual Workplace Supply Kit

Kit includes:

- (1) B30C-4000-595-WT - 4 in. B-595 white vinyl
- (1) B30C-2250-595-WT - 2.25 in. B-595 white vinyl
- (1) B30C-4000-595-YL - 4 in. B-595 yellow vinyl
- (1) B30C-2250-595-YL - 2.25 in. B-595 yellow vinyl
- (1) B30C-2250-581-WT - 2.25 in. B-581 repositionable vinyl
- (1) B30C-1125-581-WT - 1.125 in. B-581 repositionable vinyl
- (1) B30C-2500-509-WT - 2.25 in. magnetic vinyl
- (1) 142133 - Blank valve tag variety pack
- (1) B30-219-595-BLNKWT - Die-cut labels for valve tags
- (1) B30-25-595-ANSIWA - 4 in. x 6 in. B-595 caution header
- (2) B30-R10000 - Black print ribbon
- (1) B30-R10000-RD - Red print ribbon
- (1) B30-R10000-GN - Green print ribbon
- (1) B30-R10000-BL - Blue print ribbon

Catalog #	Description
142063	Lean / 5S Supply Kit - Large
S3100W-LEAN-KIT	BradyPrinter S3100 w/ Lean / 5S Supply Kit

Printer sold separately unless otherwise noted.



Pipe Identification Supply Kit

Kit includes:

- (1) B30C-4000-595-YL - 4 in. B-595 yellow vinyl
- (1) B30C-2250-595-YL - 2.25 in. B-595 yellow vinyl
- (1) B30C-1125-595-YL - 1.125 in. B-595 yellow vinyl
- (1) B30C-4000-595-GN - 4 in. B-595 green vinyl
- (1) B30C-2250-595-GN - 2.25 in. B-595 green vinyl
- (1) B30C-1125-595-GN - 1.125 in. B-595 green vinyl
- (1) B30C-1125-595-BL - 1.125 in. B-595 blue vinyl
- (1) B30C-2250-595-RD - 2.25 in. B-595 red vinyl
- (1) B30C-1125-595-RD - 1.125 in. B-595 red vinyl
- (1) B30EP-174-593-BK - 1 in. x 4 in. B-593 black raised panel
- (1) 142133 - Blank valve tag variety pack
- (1) B30-242-595-BLNKWT - Small die-cut labels for valve tags
- (3) B30-R10000 - Black print ribbon
- (2) B30-R10000-WT - White print ribbon

Catalog #	Description
142064	Pipe ID Supply Kit - Large
S3100W-PIPE-KIT	BradyPrinter S3100 w/ Pipe ID Supply Kit

Printer sold separately unless otherwise noted.



General Industrial Supply Kit

Kit includes:

- (1) B30C-4000-595-WT - 4 in. B-595 white
- (1) B30C-2250-595-WT - 2.25 in. B-595 white
- (1) B30C-1125-595-WT - 1.125 in. B-595 white vinyl
- (1) B30C-4000-595-YL - 4 in. B-595 yellow vinyl
- (1) B30C-2250-595-YL - 2.25 in. B-595 yellow vinyl
- (1) B30C-1125-595-YL - 1.125 in. B-595 yellow vinyl
- (1) B30EP-177-593-BK - 2.5 in. x 3 in. B-593 black raised panel
- (1) B30-25-595-ANSIDA - 4 in. x 6 in. B-595 ANSI danger header
- (1) B30-25-595-ANSICA - 4 in. x 6 in. B-595 ANSI caution header
- (1) B30C-2250-584-YL - 2.25 in. Reflective yellow
- (1) B30C-4250-551-WT - 4.25 in. White tag stock
- (2) B30-R10000 - Black print ribbon
- (1) B30-R10000-WT - White print ribbon
- (1) B30-R10000-RD - Red print ribbon

Catalog #	Description
142065	General Industrial Supply Kit - Large
S3100W-GEN-KIT	BradyPrinter S3100 w/ General Industrial Supply Kit

Printer sold separately unless otherwise noted.

B30-Series Print Ribbons

BradyID.com/s36

B30-Series Print Ribbons for BradyPrinter S3000, S3100, i3300, BBP®30, BBP®31, BBP®33, BBP®35 and BBP®37 printers

- Tough, smear-proof ribbons that produce long-lasting printed text and can withstand years in industrial areas and outdoor conditions
- Self-contained cartridges drop straight into printer with a click – no calibrating, threading, wasted feeding and the ink will always be facing the right direction
- Printer notifies user if installed ribbon is not recommended for installed labels

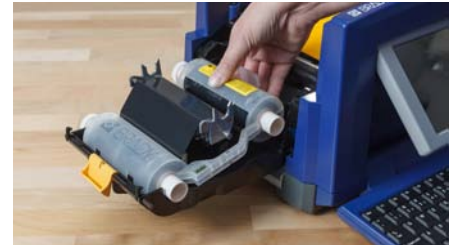

Drop and click print ribbons for 5-second ribbon supply changes

Single-Color Print Ribbons

- Solid color ribbons for printing a single color onto a label
- Can be used for printing multi-color labels on BBP35 or BBP37 printers if a paneled multi-color ribbon is not on hand
- All ribbons 4.330 in. x 200 ft. (101.9 mm x 60.9 m)

Fits Printers	Catalog #	Color
All*	B30-R10000	Black
All*	B30-R6000	Black
All*	B30-R6200	Black
All*	B30-R6400	Black
All*	B30-R6600	Black
All*	B30-R4300	Black
All*	B30-R10000-WT	White
All*	B30-R4400-WT	White
All*	B30-R6700-WT	White*
All*	B30-R4500-SV	Silver*

Fits Printers	Catalog #	Color
All*	B30-R10000-RD	Red
All*	B30-R10000-GN	Green
All*	B30-R10000-BL	Blue
All*	B30-R10000-YL	Yellow*
All*	B30-R10000-YL2	Yellow*
All*	B30-R10000-OR	Orange
All*	B30-R10000-MA	Magenta
All*	B30-R10000-PRCCY	Process Cyan**
All*	B30-R10000-PRCYEL	Process Yellow**
All*	B30-R10000-PRCMAG	Process Magenta**



* B30-R4500-SV ribbon for use with B-342 black Permasleeves only; B30-R6700-WT ribbon for use with B-345 black Permasleeves only.

** B30-R10000-YL for printing yellow onto white, B30-R10000-YL2 for printing yellow onto other colors of B-595.

*** Process ribbons print a much lighter shade. They are designed to be used with other process ribbons and black ribbon to lay down a dot pattern for printing blended colors and process color objects with the BBP35/37.

Multi-Color Paneled Print Ribbons for BBP35 and BBP37

- Ribbons have 2- or 4-color panels for printing multiple colors onto a label
- Print multiple colors without having to swap in multiple ribbons



Two-color print ribbons

Fits Printers	Catalog #	Color	Panel Size Inch (mm)	Length Feet (m)
8 inch panel length. Typical yield: 100 panel sets per roll				
BBP35, 37 Only	B30-R10000-KR-8	Black and Red	4.330 x 8.000 (101.9 x 203.2) panels	200 ft. (60.9 m)
BBP35, 37 Only	B30-R10000-KY-8	Black and Yellow	4.330 x 8.000 (101.9 x 203.2) panels	200 ft. (60.9 m)
BBP35, 37 Only	B30-R10000-KB-8	Black and Blue	4.330 x 8.000 (101.9 x 203.2) panels	200 ft. (60.9 m)
BBP35, 37 Only	B30-R10000-KO-8	Black and Orange	4.330 x 8.000 (101.9 x 203.2) panels	200 ft. (60.9 m)
BBP35, 37 Only	B30-R10000-KG-8	Black and Green	4.330 x 8.000 (101.9 x 203.2) panels	200 ft. (60.9 m)
BBP35, 37 Only	B30-R10000-GR-8	Green and Red	4.330 x 8.000 (101.9 x 203.2) panels	200 ft. (60.9 m)
16 inch panel length. Typical yield: 60 panel sets per roll				
BBP35, 37 Only	B30-R10000-KR-16	Black and Red	4.330 x 16.000 (101.9 x 604.4) panels	200 ft. (60.9 m)
BBP35, 37 Only	B30-R10000-KY-16	Black and Yellow	4.330 x 16.000 (101.9 x 604.4) panels	200 ft. (60.9 m)
BBP35, 37 Only	B30-R10000-KB-16	Black and Blue	4.330 x 16.000 (101.9 x 604.4) panels	200 ft. (60.9 m)
BBP35, 37 Only	B30-R10000-KO-16	Black and Orange	4.330 x 16.000 (101.9 x 604.4) panels	200 ft. (60.9 m)
BBP35, 37 Only	B30-R10000-KG-16	Black and Green	4.330 x 16.000 (101.9 x 604.4) panels	200 ft. (60.9 m)
BBP35, 37 Only	B30-R10000-RB-16	Red and Blue	4.330 x 16.000 (101.9 x 604.4) panels	200 ft. (60.9 m)

Four-color print ribbons

Fits Printers	Catalog #	Color	Panel Size Inch (mm)	Length Feet (m)
8 inch panel length. Typical yield: 50 panel sets per roll				
BBP35, 37 Only	B30-R10000-KRGB-8	Black, Red, Green and Blue	4.330 x 8.000 (101.9 x 203.2) panels	200 ft. (60.9 m)
BBP35, 37 Only	B30-R10000-KRYG-8	Black, Red, Yellow and Green	4.330 x 8.000 (101.9 x 203.2) panels	200 ft. (60.9 m)
BBP35, 37 Only	B30-R10000-KRYB-8	Black, Red, Yellow and Blue	4.330 x 8.000 (101.9 x 203.2) panels	200 ft. (60.9 m)
BBP35, 37 Only	B30-R10000-KRBO-8	Black, Red, Blue and Orange	4.330 x 8.000 (101.9 x 203.2) panels	200 ft. (60.9 m)
BBP35, 37 Only	B30-R10000-CMYK-8	Process Cyan, Magenta, Yellow, Black**	4.330 x 8.000 (101.9 x 203.2) panels	200 ft. (60.9 m)
16 inch panel length. Typical yield: 30 panel sets per roll				
BBP35, 37 Only	B30-R10000-KRGB-16	Black, Red, Green and Blue	4.330 x 16.000 (101.9 x 604.4) panels	200 ft. (60.9 m)
BBP35, 37 Only	B30-R10000-KRYB-16	Black, Red, Yellow and Blue	4.330 x 16.000 (101.9 x 604.4) panels	200 ft. (60.9 m)
BBP35, 37 Only	B30-R10000-CMYK-16	Process Cyan, Magenta, Yellow, Black**	4.330 x 16.000 (101.9 x 604.4) panels	200 ft. (60.9 m)

** Process ribbons print a much lighter shade. They are designed to be used together with other process ribbons and black ribbon to lay down a dot pattern for printing blended colors and process color objects with the BBP35 and BBP37 printers.

B30-Series Print Ribbons

BradyID.com/s36

Print ribbon and label material compatibility

B-# Material		B30-R4300 (Black)	B30-R6000 (Black)	B30-R6200 (Black)	B30-R6400 (Black)	B30-R6600 (Black)	B30-R10000 (Black)	B30-R4500-SV* (Silver)	B30-R4400-WT (White)	B30-R6700-WT* (White)	B30-R10000-WT (White)	B30-R10000-YL (Yellow)	B30-R10000-YL2 (Yellow)	B30-R10000 (Colors)
B-342	Polyolefin	●	-	-	-	-	-	●*	-	-	-	-	-	-
B-344	Polyolefin	-	-	-	-	●	-	-	-	●*	-	-	-	-
B-345	Polyolefin	-	●	-	-	-	-	-	●	-	-	-	-	-
B-403	Paper	●	-	-	-	-	-	-	-	-	-	-	-	-
B-422	Polyester	-	●	-	-	-	-	-	●	-	-	-	-	-
B-423	Glossy white polyester	-	●	●	-	-	-	-	-	-	-	-	-	-
B-424	Matte white paper	●	-	-	-	-	-	-	-	-	-	-	-	-
B-425	Polypropylene	●	-	-	●	-	-	-	-	-	-	-	-	-
B-427	Vinyl	●	-	-	-	-	-	-	-	-	-	-	-	-
B-428	Metallized polyester	●	-	-	-	-	-	-	-	-	-	-	-	-
B-430	Polyester	-	●	-	-	-	-	-	-	-	-	-	-	-
B-432	Glossy clear polyester	-	●	-	-	-	-	-	●	-	-	-	-	-
B-434	Glossy metallized polyester	-	●	-	-	-	-	-	-	-	-	-	-	-
B-437	Polyvinylfluoride	●	-	-	-	-	-	-	-	-	-	-	-	-
B-438	Tamper evident metallized polyester	●	-	-	-	-	-	-	-	-	-	-	-	-
B-461	Polyester	●	-	-	-	-	-	-	-	-	-	-	-	-
B-472	Polyimide	●	-	-	-	-	-	-	-	-	-	-	-	-
B-480	Metallized polyester	-	-	-	●	-	-	-	-	-	-	-	-	-
B-481	Polyester	-	-	-	●	-	-	-	-	-	-	-	-	-
B-482	Polyester	-	-	-	●	-	-	-	-	-	-	-	-	-
B-483	Glossy white polyester	-	●	-	-	-	-	-	-	-	-	-	-	-
B-483	Toughstripe® floor marking tape	-	●	-	-	-	-	-	●	-	-	-	-	-
B-484A	Glossy white polyester	-	●	-	-	-	-	-	-	-	-	-	-	-
B-486	Matte metallized polyester	●	-	-	-	-	-	-	-	-	-	-	-	-
B-489	Matte white polyester	●	-	-	-	-	-	-	-	-	-	-	-	-
B-490	Polyester	●	-	-	-	-	-	-	-	-	-	-	-	-
B-492	Polyester	-	-	-	●	-	-	-	-	-	-	-	-	-
B-494	Color polyester	-	-	-	●	-	-	-	-	-	-	-	-	-
B-498	Cloth	-	-	●	-	-	-	-	-	-	-	-	-	-
B-499	Nylon	●	●	-	-	-	-	-	-	-	-	-	-	-
B-509	Printable magnetic	-	-	-	-	-	●	-	-	-	-	-	-	●*
B-526	Photoluminescent polyester	-	-	-	-	-	●	-	-	-	-	-	-	●*
B-549	Cold temperature polyester	-	-	-	-	-	●	-	-	●	-	-	-	●*
B-551	Non-adhesive tag	-	-	-	-	-	●	-	-	-	-	-	-	●*
B-565	Metallized polyester	-	-	-	-	-	●	-	-	-	-	-	-	-
B-569	Low-halide polyester	-	-	-	-	-	●	-	-	●	-	-	-	●*
B-581	Repositionable vinyl	-	-	-	-	-	●	-	-	●	-	-	-	●*
B-584	Retro reflective	-	-	-	-	-	●	-	-	-	-	-	-	●*
B-593	Raised panel polyester	-	●	-	-	-	-	●	-	-	-	-	-	-
B-595	Outdoor vinyl	-	-	-	-	-	●	-	-	●	●**	●**	●*	-
B-717	Polyimide	-	●	-	-	-	-	-	-	-	-	-	-	-
B-718	Polyimide	-	●	-	-	-	-	-	-	-	-	-	-	-
B-719	Polyimide	-	●	-	-	-	-	-	-	-	-	-	-	-
B-724	Matte amber polyimide	●	-	-	-	-	-	-	-	-	-	-	-	-
B-727	Glossy white polyimide	-	●	-	-	-	-	-	-	-	-	-	-	-
B-854	Toughwash® metal detectable	-	●	-	-	-	-	-	-	-	-	-	-	-
B-855	Toughwash	-	●	-	-	-	-	-	-	-	-	-	-	-
B-7425	Polypropylene	-	-	-	●	-	-	-	-	-	-	-	-	-
B-7425-AC	Polypropylene	-	-	-	●	-	-	-	-	-	-	-	-	-
B-7569	Vinyl film	-	-	-	-	●	-	-	-	-	-	-	-	-
B-7641	Polyolefin	●	●	-	-	●	-	-	-	-	-	-	-	-
B-7642	Polyolefin	●	-	-	●	-	-	-	-	-	-	-	-	-
B-7643	Polyurethane	-	●	-	-	-	-	●	-	-	-	-	-	-

Refer to the corresponding Tech Data Sheets for complete material information at BradyID.com/techdata.

* B30-R4500-SV ribbon for use with B-342 black PermaSleeves® only; B30-R6700-WT ribbon for use with B-345 black PermaSleeves® only.

**Colored ribbons optimized for use on white material. Test use on other material colors for suitability to your application.

***Use B30-R10000-YL for printing yellow onto white. Use B30-R10000-YL2 for printing yellow onto other colors of B-595.

Benchtop Printers

B30 / B33 Series

BBP[®]85 Sign and Label Printer

BradyID.com/s36

Benchtop Printers



BBP[®]85 SIGN & LABEL PRINTER

**There's big and bold.
Then there's big and bold
from Brady.**

The BBP85 Sign and Label Printer allows you to create extra-large 10 inch labels in multiple colors, and it has an easier-than-ever interface that anyone on your team can use. No more complex, tedious design steps. Now you can just walk up and print – anyone can do it.

Big Output. Little Fuss.

Create custom signs and labels right now. This printer has our fastest, easiest operating system, so anyone on your team can design visuals with little to no training. The ideal printer for multi-user lean / 5S and kaizen labeling events.

- Unmistakably large visuals up to 10 in. wide
- Just walk up and print – it really is that easy
- Simple touchscreen interface for standalone use, including label design apps to quickly create safety signs, pipe markers, GHS, arc flash, right-to-know labels and more
- Connect to your PC to print labels created through Brady Workstation apps
- USB port for importing files, fonts and graphics

▶ **Learn more at
BradyID.com/bbp85**

Printer at-a-glance

- Large output up to 10 in. wide
- Single- and multi-color printing
- PC-connect or standalone printing
- Touchscreen label creation
- 125 parts, 5 materials

Printing supplies

BBP85 label rolls page 78
BBP85 print ribbons page 83

Catalog #	Description
BBP85	BBP85 Sign and Label Printer*
B85-DC	BBP85 Printer Dust Cover
STYLUS-3PK	Replacement Stylus Pens (3 per pack)

* Printer ships with documentation CD, printer driver CD, power cord, USB cord, Quick Start Guide and cleaning kit.



Big, bold and better than ever



Large signs
up to 10 in. wide



Custom signs
on demand



Equipment ID



Low light applications



GHS labels



Pipe marking

BBP85

BBP[®]85 Sign and Label Printer

BradyID.com/s36

Printer specifications

Overview	10 in. standalone and PC-connect printer for SFID with multi-color printing. Particularly popular for any large labeling needs. The ultimate in easy and accessible with multiple colors for larger output
Applications	Larger output of equipment labels, GHS labels, safety signs and multi-color labels
Label materials	Extremely aggressive 8-10 year outdoor vinyl with high tack and chemical resistance, plus reflective, 10-hour glow-in-the-dark and polyester.
Label formats	Continuous tapes, pre-printed and blank die-cut labels
Print technology	Thermal transfer
Print resolution	300 dpi
Print speed	1 in./sec.
Media widths	4 to 10 in.
Min. label dimension	4 in.
Color printing capabilities	Monocolor and multi-color printing
Auto cut-off	Yes
X-Y plotter cutting (cutout shapes / text)	No
PC-connect or standalone operation	Standalone and PC-connect printing
Connectivity options	Standard: USB, Ethernet Optional: Wi-Fi, Wi-Fi Direct
Compatible software	Brady Workstation Apps
Compatible materials	B85-series and PowerMark materials
Compatible ribbons	B85-series and Powermark ribbons
Calibration required	No (no waste)
Label creation and set-up	Automatic (printer or PC software reads data on chip and automatically sets up label size, color, fonts, etc.)
Ribbon and label roll installation	Labels: Supplied in cartridge, drops into place, 15-second changeover Ribbon: Supplied in cartridge, snaps into place, 5-second changeover
Warranty	5 years

* Patent No. 8,542,155; 8,783,983.
Additional patents pending.



Brady Workstation Safety and Facility ID Suite

Brady Workstation has revolutionized how you design and print labels from your PC. When paired with the high-performance printing capabilities of a Brady printer, you get intuitive label set up for simple, efficient and flexible label creation.

This suite features:

- A collection of applications for creating the custom signs, labels and pipe markers you need to add visual safety guidance to your facility
- The ability to serialize and import your data onto the labels
- Real-time information about the label material installed, enabling easy label set up
- Built-in regulations, standards, pictograms, common phrases, data importation guidance, help functions and more

▶ **Learn more on page 176 or download a free trial at Workstation.BradylD.com**

Brady360[®] 5-year Warranty



We stand behind our products and have strengthened our commitment to you with a **5-year printer warranty standard and free of charge** on our benchtop printer models.* With our team of certified tech support and repair technicians, you can rest easy knowing you have the support you need, every step of the way.

*Excludes repairs due to negligence. Excludes Wrapator™, BradyJet and portable models. For full coverage details and restrictions, visit BradyID.com/brady360

Benchtop Printers

BBP85

BBP®85 Label Materials

BradyID.com/s36

Indoor / Outdoor Grade Vinyl Tape (B-595)

- Durable, low-shrink vinyl with our most aggressive adhesive and 8-10 year outdoor durability
- Conforms to irregular, curved, rough and highly textured surfaces (painted cinder blocks and wood, textured plastics, cast-iron and paper-jacketed pipes, powder-coated surfaces)

Service temp: -40° F to 180° F; Application temp: 0° F to 180° F
Average outdoor durability: 8-10 year outdoor vinyl label durability



Figure 33



Benchtop Printers

BBP85

Fits Printers	Figure	Catalog #	B#	Color	Label Width A Inch (mm)	Roll Length B Feet (m)	Labels Per Roll	Rec. Ribbon
BBP85, PMK	Fig. 33	13538	B-595	White	4.000 (101.6)	50 (15.2)	1 roll (cont)	13511
BBP85, PMK	Fig. 33	13549	B-595	White	6.000 (152.4)	50 (15.2)	1 roll (cont)	13511
BBP85, PMK	Fig. 33	13651	B-595	White	7.000 (177.8)	50 (15.2)	1 roll (cont)	13510
BBP85, PMK	Fig. 33	13551	B-595	White	8.000 (203.2)	50 (15.2)	1 roll (cont)	13510
BBP85, PMK	Fig. 33	13562	B-595	White	10.000 (254.0)	50 (15.2)	1 roll (cont)	13510
BBP85, PMK	Fig. 33	13539	B-595	Yellow	4.000 (101.6)	50 (15.2)	1 roll (cont)	13511
BBP85, PMK	Fig. 33	13550	B-595	Yellow	6.000 (152.4)	50 (15.2)	1 roll (cont)	13511
BBP85, PMK	Fig. 33	13652	B-595	Yellow	7.000 (177.8)	50 (15.2)	1 roll (cont)	13510
BBP85, PMK	Fig. 33	13552	B-595	Yellow	8.000 (203.2)	50 (15.2)	1 roll (cont)	13510
BBP85, PMK	Fig. 33	13563	B-595	Yellow	10.000 (254.0)	50 (15.2)	1 roll (cont)	13510
BBP85, PMK	Fig. 33	13540	B-595	Red	4.000 (101.6)	50 (15.2)	1 roll (cont)	13513
BBP85, PMK	Fig. 33	13601	B-595	Red	6.000 (152.4)	50 (15.2)	1 roll (cont)	13513
BBP85, PMK	Fig. 33	13654	B-595	Red	7.000 (177.8)	50 (15.2)	1 roll (cont)	13512
BBP85, PMK	Fig. 33	13553	B-595	Red	8.000 (203.2)	50 (15.2)	1 roll (cont)	13512
BBP85, PMK	Fig. 33	13610	B-595	Red	10.000 (254.0)	50 (15.2)	1 roll (cont)	13512
BBP85, PMK	Fig. 33	13541	B-595	Blue	4.000 (101.6)	50 (15.2)	1 roll (cont)	13513
BBP85, PMK	Fig. 33	13602	B-595	Blue	6.000 (152.4)	50 (15.2)	1 roll (cont)	13513
BBP85, PMK	Fig. 33	13656	B-595	Blue	7.000 (177.8)	50 (15.2)	1 roll (cont)	13512
BBP85, PMK	Fig. 33	13554	B-595	Blue	8.000 (203.2)	50 (15.2)	1 roll (cont)	13512
BBP85, PMK	Fig. 33	13611	B-595	Blue	10.000 (254.0)	50 (15.2)	1 roll (cont)	13512
BBP85, PMK	Fig. 33	13542	B-595	Green	4.000 (101.6)	50 (15.2)	1 roll (cont)	13513
BBP85, PMK	Fig. 33	13603	B-595	Green	6.000 (152.4)	50 (15.2)	1 roll (cont)	13513
BBP85, PMK	Fig. 33	13655	B-595	Green	7.000 (177.8)	50 (15.2)	1 roll (cont)	13512
BBP85, PMK	Fig. 33	13555	B-595	Green	8.000 (203.2)	50 (15.2)	1 roll (cont)	13512
BBP85, PMK	Fig. 33	13612	B-595	Green	10.000 (254.0)	50 (15.2)	1 roll (cont)	13512
BBP85, PMK	Fig. 33	13543	B-595	Orange	4.000 (101.6)	50 (15.2)	1 roll (cont)	13511
BBP85, PMK	Fig. 33	13604	B-595	Orange	6.000 (152.4)	50 (15.2)	1 roll (cont)	13511
BBP85, PMK	Fig. 33	13653	B-595	Orange	7.000 (177.8)	50 (15.2)	1 roll (cont)	13510
BBP85, PMK	Fig. 33	13556	B-595	Orange	8.000 (203.2)	50 (15.2)	1 roll (cont)	13510
BBP85, PMK	Fig. 33	13613	B-595	Orange	10.000 (254.0)	50 (15.2)	1 roll (cont)	13510
BBP85, PMK	Fig. 33	13544	B-595	Black	4.000 (101.6)	50 (15.2)	1 roll (cont)	13513
BBP85, PMK	Fig. 33	13605	B-595	Black	6.000 (152.4)	50 (15.2)	1 roll (cont)	13513
BBP85, PMK	Fig. 33	13557	B-595	Black	8.000 (203.2)	50 (15.2)	1 roll (cont)	13512
BBP85, PMK	Fig. 33	13614	B-595	Black	10.000 (254.0)	50 (15.2)	1 roll (cont)	13512
BBP85, PMK	Fig. 33	13545	B-595	Gold	4.000 (101.6)	50 (15.2)	1 roll (cont)	13511
BBP85, PMK	Fig. 33	13606	B-595	Gold	6.000 (152.4)	50 (15.2)	1 roll (cont)	13511
BBP85, PMK	Fig. 33	13558	B-595	Gold	8.000 (203.2)	50 (15.2)	1 roll (cont)	13510
BBP85, PMK	Fig. 33	13615	B-595	Gold	10.000 (254.0)	50 (15.2)	1 roll (cont)	13510
BBP85, PMK	Fig. 33	13546	B-595	Gray	4.000 (101.6)	50 (15.2)	1 roll (cont)	13511
BBP85, PMK	Fig. 33	13607	B-595	Gray	6.000 (152.4)	50 (15.2)	1 roll (cont)	13511
BBP85, PMK	Fig. 33	13559	B-595	Gray	8.000 (203.2)	50 (15.2)	1 roll (cont)	13510
BBP85, PMK	Fig. 33	13616	B-595	Gray	10.000 (254.0)	50 (15.2)	1 roll (cont)	13510
BBP85, PMK	Fig. 33	13547	B-595	Brown	4.000 (101.6)	50 (15.2)	1 roll (cont)	13513
BBP85, PMK	Fig. 33	13608	B-595	Brown	6.000 (152.4)	50 (15.2)	1 roll (cont)	13513
BBP85, PMK	Fig. 33	13560	B-595	Brown	8.000 (203.2)	50 (15.2)	1 roll (cont)	13512
BBP85, PMK	Fig. 33	13617	B-595	Brown	10.000 (254.0)	50 (15.2)	1 roll (cont)	13512
BBP85, PMK	Fig. 33	13548	B-595	Purple	4.000 (101.6)	50 (15.2)	1 roll (cont)	13513
BBP85, PMK	Fig. 33	13609	B-595	Purple	6.000 (152.4)	50 (15.2)	1 roll (cont)	13513
BBP85, PMK	Fig. 33	13561	B-595	Purple	8.000 (203.2)	50 (15.2)	1 roll (cont)	13512
BBP85, PMK	Fig. 33	13618	B-595	Purple	10.000 (254.0)	50 (15.2)	1 roll (cont)	13512
BBP85, PMK	Fig. 33	59529	B-595	Clear	4.000 (101.6)	50 (15.2)	1 roll (cont)	13511
BBP85, PMK	Fig. 33	59530	B-595	Clear	6.000 (152.4)	50 (15.2)	1 roll (cont)	13511
BBP85, PMK	Fig. 33	59531	B-595	Clear	8.000 (203.2)	50 (15.2)	1 roll (cont)	13510
BBP85, PMK	Fig. 33	59532	B-595	Clear	10.000 (254.0)	50 (15.2)	1 roll (cont)	13510

U.S. Patent No. 5,318,370; 5,823,689; 6,570,602. Additional patents pending.

Low-Halide Polyester (B-569)

- For labeling stainless steel and smooth surfaces
- Low-halide content for labeling stainless steel surfaces
- Applies best to very smooth surfaces and is ideal for mounting to rigid panels

Service temp: -40° F to 212° F; Application temp: 0° F to 212° F
Average outdoor durability: 3-5 years



Figure 33



Fits Printers	Figure	Catalog #	B#	Color	Label Width A Inch (mm)	Roll Length B Feet (m)	Labels Per Roll	Rec. Ribbon
BBP85, PMK	Fig. 33	13565	B-569	White	4.000 (101.6)	50 (15.2)	1 roll (cont)	13511
BBP85, PMK	Fig. 33	13569	B-569	White	6.000 (152.4)	50 (15.2)	1 roll (cont)	13511
BBP85, PMK	Fig. 33	13573	B-569	White	7.000 (177.8)	50 (15.2)	1 roll (cont)	13510
BBP85, PMK	Fig. 33	13577	B-569	White	10.000 (254.0)	50 (15.2)	1 roll (cont)	13510
BBP85, PMK	Fig. 33	13566	B-569	Yellow	4.000 (101.6)	50 (15.2)	1 roll (cont)	13511
BBP85, PMK	Fig. 33	13570	B-569	Yellow	6.000 (152.4)	50 (15.2)	1 roll (cont)	13511
BBP85, PMK	Fig. 33	13574	B-569	Yellow	7.000 (177.8)	50 (15.2)	1 roll (cont)	13510
BBP85, PMK	Fig. 33	13578	B-569	Yellow	10.000 (254.0)	50 (15.2)	1 roll (cont)	13510
BBP85, PMK	Fig. 33	13567	B-569	Orange	4.000 (101.6)	50 (15.2)	1 roll (cont)	13511
BBP85, PMK	Fig. 33	13571	B-569	Orange	6.000 (152.4)	50 (15.2)	1 roll (cont)	13511
BBP85, PMK	Fig. 33	13575	B-569	Orange	7.000 (177.8)	50 (15.2)	1 roll (cont)	13510
BBP85, PMK	Fig. 33	13579	B-569	Orange	10.000 (254.0)	50 (15.2)	1 roll (cont)	13510
BBP85, PMK	Fig. 33	99167	B-569	Ochre	4.000 (101.6)	50 (15.2)	1 roll (cont)	13511
BBP85, PMK	Fig. 33	99168	B-569	Ochre	6.000 (152.4)	50 (15.2)	1 roll (cont)	13511
BBP85, PMK	Fig. 33	99169	B-569	Ochre	7.000 (177.8)	50 (15.2)	1 roll (cont)	13510
BBP85, PMK	Fig. 33	99170	B-569	Ochre	10.000 (254.0)	50 (15.2)	1 roll (cont)	13510
BBP85, PMK	Fig. 33	13564	B-569	Clear	4.000 (101.6)	50 (15.2)	1 roll (cont)	13511
BBP85, PMK	Fig. 33	13568	B-569	Clear	6.000 (152.4)	50 (15.2)	1 roll (cont)	13511
BBP85, PMK	Fig. 33	13572	B-569	Clear	7.000 (177.8)	50 (15.2)	1 roll (cont)	13510
BBP85, PMK	Fig. 33	13576	B-569	Clear	10.000 (254.0)	50 (15.2)	1 roll (cont)	13510

PowerMark™ Label Maker Materials

The BBP85 printer accepts many of the same materials that the PowerMark. Simply look for “BBP85” or “A” on the supply roll’s label to verify compatibility with both models.

Questions?

Call Brady Tech Support at 1-800-643-8766.

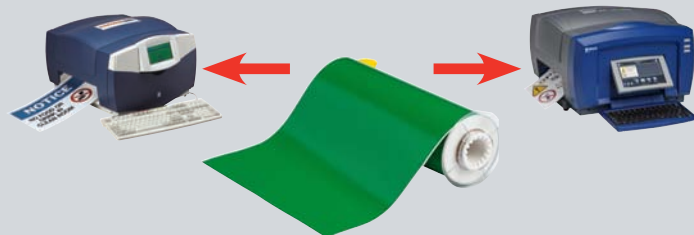

BBP®85 Label Materials

BradyID.com/s36

Pre-Printed GHS / CLP Chemical Labels (B-7569)

- For GHS and hazard communication labeling
- Blank labels with pre-printed red diamonds save time during label printing
- 6 diamond layouts that match templates in Brady Workstation App and standalone printer app
- Indoor / outdoor vinyl withstands exposure to moisture, chemicals and handling

Service temp: -4° F to 180° F; Application temp: 50° F to 180° F
Average outdoor durability: 3-5 years



Benchtop Printers

Fits Printers	Catalog #	B#	Legend	Label Height Inch (mm)	Label Width Inch (mm)	Labels Per Row	Labels Per Roll	Rec. Ribbon
BBP85	130766	B-7569		4.100 (104.1)	6.100 (154.9)	1	90	13511
BBP85	130772	B-7569		6.100 (154.9)	8.300 (210.8)	1	70	13510
BBP85	130767	B-7569		4.100 (104.1)	6.100 (154.9)	1	90	13511
BBP85	130773	B-7569		6.100 (154.9)	8.300 (210.8)	1	70	13510
BBP85	130768	B-7569		4.100 (104.1)	6.100 (154.9)	1	90	13511
BBP85	130774	B-7569		6.100 (154.9)	8.300 (210.8)	1	70	13510
BBP85	130769	B-7569		4.100 (104.1)	6.100 (154.9)	1	90	13511
BBP85	130775	B-7569		6.100 (154.9)	8.300 (210.8)	1	70	13510
BBP85	130770	B-7569		4.100 (104.1)	6.100 (154.9)	1	90	13511
BBP85	130776	B-7569		6.100 (154.9)	8.300 (210.8)	1	70	13510
BBP85	130771	B-7569		4.100 (104.1)	6.100 (154.9)	1	90	13511
BBP85	130777	B-7569		6.100 (154.9)	8.300 (210.8)	1	70	13510

Pre-Printed Pre-Cut Blank Sign Headers (B-595, B-7569)

- For creating arc flash and safety warning labels in seconds
- Create custom, colorful safety labels using only a black ribbon
- Meet NFPA 70E, OSHA 1910.145 and ASME / ANSI Z535 standards
- Indoor / outdoor grade material conforms to rough, highly textured, and difficult to adhere to surfaces

B-595 vinyl: Service temp: -40° F to 180° F; Application temp: 0° F to 180° F
Average outdoor durability: 8-10 years outdoor vinyl durability

B-7569 vinyl: Service temp: -4° F to 167° F; Application temp: 50° F to 167° F
Average outdoor durability: Up to 3 years vinyl durability

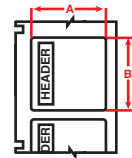

Figure 70

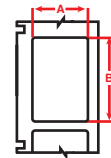

Figure 82



Fits Printers	Figure	Catalog #	B#	Header	Label Height A Inch (mm)	Label Width B Inch (mm)	Labels Per Roll	Rec. Ribbon
BBP85	Fig. 70	140886	B-7569		10.000 (254.0)	14.000 (355.6)	40	13510
BBP85	Fig. 70	130750	B-595		7.000 (177.8)	10.000 (254.0)	60	13510
BBP85	Fig. 70	130749	B-595		4.000 (101.6)	6.000 (152.4)	95	13511
BBP85	Fig. 70	140887	B-7569		10.000 (254.0)	14.000 (355.6)	40	13510
BBP85	Fig. 70	130753	B-595		7.000 (177.8)	10.000 (254.0)	60	13510
BBP85	Fig. 70	130752	B-595		4.000 (101.6)	6.000 (152.4)	95	13511
BBP85	Fig. 70	140888	B-7569		10.000 (254.0)	14.000 (355.6)	40	13510
BBP85	Fig. 70	130756	B-595		7.000 (177.8)	10.000 (254.0)	60	13510
BBP85	Fig. 70	130755	B-595		4.000 (101.6)	6.000 (152.4)	95	13511
BBP85	Fig. 70	140889	B-7569		10.000 (254.0)	14.000 (355.6)	40	13510
BBP85	Fig. 70	130759	B-595		7.000 (177.8)	10.000 (254.0)	60	13510
BBP85	Fig. 70	130758	B-595		4.000 (101.6)	6.000 (152.4)	95	13511
BBP85	Fig. 70	140885	B-7569		10.000 (254.0)	14.000 (355.6)	40	13510
BBP85	Fig. 70	130762	B-595		7.000 (177.8)	10.000 (254.0)	60	13510
BBP85	Fig. 70	130761	B-595		4.000 (101.6)	6.000 (152.4)	95	13511
BBP85	Fig. 70	140890	B-7569		10.000 (254.0)	14.000 (355.6)	40	13510
BBP85	Fig. 70	130765	B-595		7.000 (177.8)	10.000 (254.0)	60	13510
BBP85	Fig. 70	130764	B-595		4.000 (101.6)	6.000 (152.4)	95	13511
BBP85	Fig. 82	140883	B-7569		10.000 (254.0)	14.000 (355.6)	40	13510
BBP85	Fig. 82	132393	B-595		7.000 (177.8)	10.000 (254.0)	60	13510
BBP85	Fig. 82	140884	B-7569		10.000 (254.0)	14.000 (355.6)	40	13510
BBP85	Fig. 82	132395	B-595		7.000 (177.8)	10.000 (254.0)	60	13510

BBP85

Creating On-Demand Rigid Signs

Rigid Sign Blanks

Create your own rigid signs using printed output from your Brady printer and rigid sign panels.

Three mounding techniques to choose from:

- Mount label to a rigid sign panel using the label's pressure sensitive adhesive
- Use the BLS1255 Laminating System to laminate output to a rigid sign panel
- Mount label behind a clear acrylic sign panel using the panel's included pressure sensitive adhesive



Aluminum panels

Catalog #	Material	Color	Height (inch)	Length (inch)	Qty
146083	Alum.	Wht	2.500	6.260	10
146113	Alum.	Wht	2.500	10.250	10
13629	Alum.	Wht	4.250	6.250	10
106461	Alum.	Wht	4.250	10.250	10
146082	Alum.	Wht	4.250	14.250	10
13632	Alum.	Wht	7.250	10.250	10
106460	Alum.	Wht	7.630	10.380	10
106462	Alum.	Wht	10.250	10.250	10
13635	Alum.	Wht	10.250	14.250	10
146116	Alum.	Ylw	2.500	6.260	10
146117	Alum.	Ylw	2.500	10.250	10
13630	Alum.	Ylw	4.250	6.250	10
146114	Alum.	Ylw	4.250	10.250	10
146115	Alum.	Ylw	4.250	14.250	10
13633	Alum.	Ylw	7.625	10.375	10
13636	Alum.	Ylw	10.250	14.250	10
13631	Alum.	Org	4.250	6.250	10
13634	Alum.	Org	7.625	10.375	10
15Y885	Alum.	Org	10.250	14.250	10

Plastic panels

Catalog #	Material	Color	Height (inch)	Length (inch)	Qty
146076	Plastic	Wht	2.500	6.250	10
146077	Plastic	Wht	2.500	10.250	10
13620	Plastic	Wht	4.250	6.250	10
146074	Plastic	Wht	4.250	10.250	10
146075	Plastic	Wht	4.250	14.250	10
13623	Plastic	Wht	7.630	10.380	10
146080	Plastic	Ylw	2.500	6.250	10
146081	Plastic	Ylw	2.500	10.250	10
13621	Plastic	Ylw	4.250	6.250	10
146078	Plastic	Ylw	4.250	10.250	10
146079	Plastic	Ylw	4.250	14.250	10
13622	Plastic	Org	4.250	6.250	10
13625	Plastic	Org	7.630	10.380	10
13628	Plastic	Org	10.250	14.250	10

Clear acrylic panels

Includes pressure sensitive adhesive backing to mount output behind the clear panel — protecting the graphics

Catalog #	Material	Color	Height (inch)	Length (inch)	Qty
13638	Acrylic	Clear	4.000	6.000	10
106464	Acrylic	Clear	4.250	10.250	10
13639	Acrylic	Clear	7.250	10.000	10
106463	Acrylic	Clear	7.250	10.250	10
13640	Acrylic	Clear	10.000	14.000	10
106465	Acrylic	Clear	10.25 in.	10.25 in.	10

BLS1255 Laminating System

BLS1255 laminator enables you to quickly and easily make custom rigid signs for your facility

- Mount signs to rigid panels to create signs for your facility
- Fast and easy to use
- No heat or electricity needed
- Laminate documents up to 12 in. wide



Catalog #	Description
105038	BLS1255 Laminating System
105041	12 in. x 50 ft. Double-Sided Polyester Overlamine



Laminates documents up to 12 in. wide

BBP®85 Label Materials

BradyID.com/s36

Benchtop Printers

Pre-Printed Right-To-Know Chemical Labels (B-595)

- For quickly creating NFPA and color bar labels
- Blank die-cut labels pre-printed with chemical diamonds and color bars
- Indoor / outdoor grade material withstands exposure to moisture, chemicals and handling
- Allows printer to produce 5-color chemical labels in a single print pass

Service temp: -40° F to 180° F; Application temp: 0° F to 180° F
Average outdoor durability: 8 to 10 years outdoor vinyl label durability



Fits Printers	Catalog #	B#	Legend	Label Height Inch (mm)	Label Width Inch (mm)	Labels Per Row	Labels Per Roll	Rec. Ribbon
BBP85	130808	B-595		4.000 (101.6)	6.000 (152.4)	1	95	13511
BBP85	130809	B-595		7.000 (177.8)	10.000 (254.0)	1	60	13510
BBP85	130810	B-595		6.000 (152.4)	6.000 (152.4)	1	95	13511
BBP85	130811	B-595		4.000 (101.6)	6.000 (152.4)	1	95	13511
BBP85	130812	B-595		7.000 (177.8)	10.000 (254.0)	1	60	13510

Retro Reflective Tape (B-584)

- For highly reflective identification that shines back brightly when struck by light
- Ideal for labeling outdoor metal utility poles, pedestals, jobsite equipment and roof-top equipment especially in low light

Service temp: -40° F to 158° F; Average outdoor durability: 4 to 6 years
Application temp: 0° F to 158° F (yellow and orange), 50° F to 158° F (silver)



Figure 33

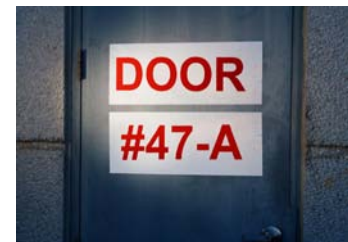

Fits Printers	Figure	Catalog #	B#	Color	Label Width A Inch (mm)	Roll Length B Feet (m)	Labels Per Roll	Rec. Ribbon
BBP85, PMK	Fig. 33	13580	B-584	Silver	4.000 (101.6)	33 (10.0)	1 roll (cont)	13511
BBP85, PMK	Fig. 33	13585	B-584	Silver	7.000 (177.8)	33 (10.0)	1 roll (cont)	13510
BBP85, PMK	Fig. 33	13590	B-584	Silver	10.000 (254.0)	33 (10.0)	1 roll (cont)	13510
BBP85, PMK	Fig. 33	51584	B-584	Yellow	4.000 (101.6)	33 (10.0)	1 roll (cont)	13511
BBP85, PMK	Fig. 33	51585	B-584	Yellow	7.000 (177.8)	33 (10.0)	1 roll (cont)	13510
BBP85, PMK	Fig. 33	51586	B-584	Yellow	10.000 (254.0)	33 (10.0)	1 roll (cont)	13510
BBP85, PMK	Fig. 33	13404	B-584	Orange	4.000 (101.6)	33 (10.0)	1 roll (cont)	13511
BBP85, PMK	Fig. 33	13403	B-584	Orange	7.000 (177.8)	33 (10.0)	1 roll (cont)	13510
BBP85, PMK	Fig. 33	13402	B-584	Orange	10.000 (254.0)	33 (10.0)	1 roll (cont)	13510

BBP85

BradyGlo™ High-Intensity Photoluminescent Tape (B-526)

- Identification that glows in the dark for up to 10 hours
- Ideal for marking emergency utility shut-offs, fire extinguishers, alarm pulls, and vital equipment controls

Service temp: -40° F to 140° F; Application temp: 40° F to 140° F



Figure 33



Fits Printers	Figure	Catalog #	B#	Color	Label Width A Inch (mm)	Roll Length B Feet (m)	Labels Per Roll	Rec. Ribbon
BBP85, PMK	Fig. 33	105912	B-526	Luminous Green	4.000 (101.6)	33 (10.0)	1 roll (cont)	13511 or 13595
BBP85, PMK	Fig. 33	105913	B-526	Luminous Green	7.000 (177.8)	33 (10.0)	1 roll (cont)	13510 or 13514
BBP85, PMK	Fig. 33	105914	B-526	Luminous Green	10.000 (254.0)	33 (10.0)	1 roll (cont)	13510 or 13514

BBP85 Printer Ribbons

Choose from a variety of heavy-duty, smear-proof ribbons, including single color and multi-color paneled ribbons. These ribbons are uniquely designed with memory cells that communicate information to the BBP85 printer.

Single color print ribbons

Fits Printers	Catalog #	Color	Size Inch (mm)	Length Foot (m)
BBP85, PMK	13511	Black	6.250 (158.0)	200 (60.9)
BBP85, PMK	13510	Black	8.800 (224.0)	200 (60.9)
BBP85, PMK	13513	White	6.250 (158.0)	200 (60.9)
BBP85, PMK	13512	White	8.800 (224.0)	200 (60.9)
BBP85, PMK	13595	Red	6.250 (158.0)	200 (60.9)
BBP85, PMK	13514	Red	8.800 (224.0)	200 (60.9)
BBP85, PMK	13596	Blue	6.250 (158.0)	200 (60.9)
BBP85, PMK	13515	Blue	8.800 (224.0)	200 (60.9)
BBP85, PMK	13597	Green	6.250 (158.0)	200 (60.9)
BBP85, PMK	13516	Green	8.800 (224.0)	200 (60.9)
BBP85, PMK	13598	Magenta	6.250 (158.0)	200 (60.9)
BBP85, PMK	13517	Magenta	8.800 (224.0)	200 (60.9)
BBP85, PMK	13599	Yellow	6.250 (158.0)	200 (60.9)
BBP85, PMK	13518	Yellow	8.800 (224.0)	200 (60.9)
BBP85, PMK	13600	Orange	6.250 (158.0)	200 (60.9)
BBP85, PMK	13519	Orange	8.800 (224.0)	200 (60.9)

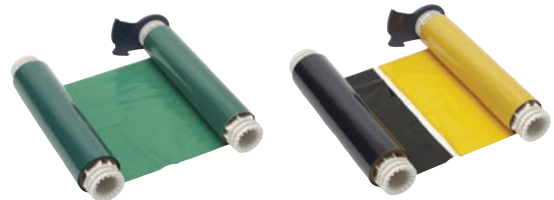

Single color print ribbon

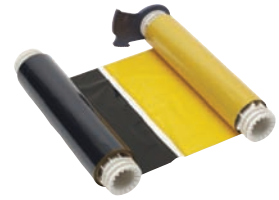

Two-color panel print ribbon

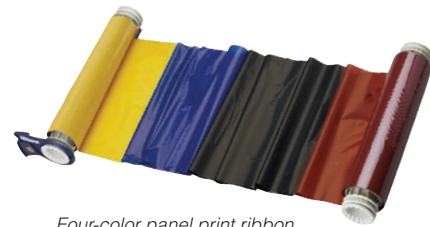

Four-color panel print ribbon

Two-color panel print ribbons

Fits Printers	Catalog #	Color	Ribbon Width Inch (mm)	Color Panel Length Inch (mm)	Overall Length Feet (m)	Typical Yield From Ribbon
8 in. panels used to create two color signs up to 8 in. long						
BBP85, PMK	13523	Black and Red	6.250 (158.0)	8.000 (203.2)	200 (60.9)	100 labels (8 in.)
BBP85, PMK	13522	Black and Red	8.800 (223.5)	8.000 (203.2)	200 (60.9)	100 labels (8 in.)
BBP85, PMK	13527	Black and Yellow	6.250 (158.0)	8.000 (203.2)	200 (60.9)	100 labels (8 in.)
BBP85, PMK	13529	Black and Orange	6.250 (158.0)	8.000 (203.2)	200 (60.9)	100 labels (8 in.)
BBP85, PMK	13704	Black and Green	6.250 (158.0)	8.000 (203.2)	200 (60.9)	100 labels (8 in.)
BBP85, PMK	13706	Black and Green	8.800 (223.5)	8.000 (203.2)	200 (60.9)	100 labels (8 in.)
15 in. panels used to create two color signs up to 14 in. long						
BBP85, PMK	13521	Black and Red	6.250 (158.0)	15.000 (381.0)	200 (60.9)	60 labels (14 in.)
BBP85, PMK	13520	Black and Red	8.800 (223.5)	15.000 (381.0)	200 (60.9)	60 labels (14 in.)
BBP85, PMK	13525	Black and Blue	6.250 (158.0)	15.000 (381.0)	200 (60.9)	60 labels (14 in.)
BBP85, PMK	13524	Black and Blue	8.800 (223.5)	15.000 (381.0)	200 (60.9)	60 labels (14 in.)
BBP85, PMK	13526	Black and Yellow	8.800 (223.5)	15.000 (381.0)	200 (60.9)	60 labels (14 in.)
BBP85, PMK	13528	Black and Orange	8.800 (223.5)	15.000 (381.0)	200 (60.9)	60 labels (14 in.)
BBP85, PMK	13705	Black and Green	6.250 (158.0)	15.000 (381.0)	200 (60.9)	60 labels (14 in.)
BBP85, PMK	13707	Black and Green	8.800 (223.5)	15.000 (381.0)	200 (60.9)	60 labels (14 in.)

Four-color panel print ribbons

Fits Printers	Catalog #	Color	Ribbon Width Inch (mm)	Color Panel Length Inch (mm)	Overall Length Feet (m)	Typical Yield From Ribbon
8 in. panels used to create four color signs up to 8 in. long						
BBP85, PMK	13533	Black / Red / Blue / Yellow	6.250 (158.0)	8.000 (203.2)	200 (60.9)	50 labels (8 in.)
BBP85, PMK	13532	Black / Red / Blue / Yellow	8.800 (223.5)	8.000 (203.2)	200 (60.9)	50 labels (8 in.)
BBP85, PMK	13537	Black / Red / Blue / Green	6.250 (158.0)	8.000 (203.2)	200 (60.9)	50 labels (8 in.)
BBP85, PMK	13536	Black / Red / Blue / Green	8.800 (223.5)	8.000 (203.2)	200 (60.9)	50 labels (8 in.)
BBP85, PMK	51448	Black / Red / Orange / Blue	8.800 (223.5)	8.000 (203.2)	200 (60.9)	50 labels (8 in.)
15 in. panels used to create four color signs up to 14 in. long						
BBP85, PMK	13531	Black / Red / Blue / Yellow	6.250 (158.0)	15.000 (381.0)	200 (60.9)	30 labels (14 in.)
BBP85, PMK	13530	Black / Red / Blue / Yellow	8.800 (223.5)	15.000 (381.0)	200 (60.9)	30 labels (14 in.)
BBP85, PMK	13535	Black / Red / Blue / Green	6.250 (158.0)	15.000 (381.0)	200 (60.9)	30 labels (14 in.)
BBP85, PMK	13534	Black / Red / Blue / Green	8.800 (223.5)	15.000 (381.0)	200 (60.9)	30 labels (14 in.)

BradyJet J2000 Color Label Printer

BradyID.com/s36

Benchtop Printers



new



BradyJet J2000

COLOR LABEL PRINTER

Improve productivity and safety with color

Get the impactful color labels you need to create a safer, more efficient workplace. The BradyJet J2000 Color Label Printer is a compact on-demand, mid-volume inkjet solution for creating photo-quality color labels in a single pass, while improving efficiency and saving you money. With the BradyJet J2000 you'll benefit from:

Colorful identification – get more impactful identification with more than 16 million color options for your labels

Quick identification when you need it – efficient printing means you keep your workplace running smoothly

Savings on costs and space – get custom identification in a small footprint without the high cost of outsourced printing

▶ **Learn more at**
BradyID.com/J2000

Printer at-a-glance

- Full-color CMYK inkjet printing
- Fast 2.5 in. per second print speeds
- Output up to 4 inches wide
- Small and lightweight at only 7 lbs
- 15 SFID parts, 2 materials

Printing supplies

J20-series materials page 85
J20-series ink cartridge see table



**1 ink cartridge =
16 million colors**



Catalog #	Description
J2000	BradyJet J2000 Inkjet Label Printer
J2000-BWSSFID	BradyJet J2000 with Brady Workstation SFID Suite
J20-CMY	J20 Ink Cartridge
J20-PAD	J20 Ink Pads
J20-ROLL	J20 material roll for print head alignment

* Printer ships with ink cartridge, material roll for printhead alignment only, USB with drivers and manuals, power cord, USB cable and Quick Start Guide.



Improve productivity and safety



Photo signage



GHS labeling



Pipe marking

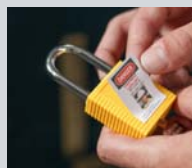

Lock labels



Facility tags



And more

J2000

BradyJet J2000 Color Label Printer

BradyID.com/s36

Printer specifications

Description	Full-color, high-resolution ink jet printer for creating photo-quality labels in a single pass, while reducing inventory of labeling supplies. Significantly smaller footprint than BradyJet J5000
Applications	GHS labels, pipe markers, warehouse marking, visual workplace labeling, lean / 5S labels, lockout tags, general ID Industrial ID, laboratory ID
Label material types	Inkjet receptive topcoated vinyl, polyester and tagstock
Types of labels	Continuous and die-cut labels
Print technology	Thermal inkjet
Print resolution	Up to 4800 dpi
Max print width	4 in.
Media widths	1.125 to 4.25 in.
Minimum label size	1.125 in.
Color printing capabilities	Full-color process; up to 16.7 million colors
Auto cut-off	Yes
X-Y plotter cutting	No
PC-connect or standalone operation	PC-connect only
Connectivity options	USB only
Compatible software	Brady Workstation Apps
Compatible materials	J20 series (all)
Calibration required	Required only on initial setup
Ink and label roll installation	Labels: Supplied as rolls, 20-second changeover Ink: Supplied as cartridge, 10-second changeover
Warranty	1 year*

*See BradyID.com/brady360 for coverage details.



Brady Workstation Safety and Facility ID Suite

Brady Workstation has revolutionized how you design and print labels from your PC. When paired with the high-performance printing capabilities of a Brady printer, you get intuitive label set up for simple, efficient and flexible label creation.

This suite features:

- A collection of applications for creating the custom signs, labels and pipe markers you need to add visual safety guidance to your facility
- The ability to serialize and import your data onto the labels
- Real-time information about the label material installed, enabling easy label set up
- Built-in regulations, standards, pictograms, common phrases, data importation guidance, help functions and more

▶ Learn more on page 176 or download a free trial at Workstation.BradyID.com

BradyJet J2000 Label Materials

BradyJet J2000 materials feature a topcoat that enhances the colors and protects your print from smudging and harsh conditions. These labels have been tested to withstand exposure to liquids, alcohol and chemicals, as well as indoor fluorescent and UV lighting.

Die-cut Labels

Figure	Catalog #	B#	Material	Color	Label Width A Inch (mm)	Label Height B Inch (mm)	Labels Per Roll
Fig. 2	J20-260-2569	B-2569	Polyester	White	2.170 (55.11)	3.350 (85.09)	340
Fig. 2	J20-261-2569	B-2569	Polyester	White	2.950 (74.93)	4.330 (109.98)	270
Fig. 2	J20-262-2569	B-2569	Polyester	White	4.130 (104.90)	6.100 (154.94)	200
Fig. 2	J20-260-2595	B-2595	Vinyl	White	2.170 (55.11)	3.350 (85.09)	340
Fig. 2	J20-261-2595	B-2595	Vinyl	White	2.950 (74.93)	4.330 (109.98)	270
Fig. 2	J20-262-2595	B-2595	Vinyl	White	4.130 (104.90)	6.100 (154.94)	200

Continuous Material

Figure	Catalog #	B#	Material	Color	Label Width A Inch (mm)	Roll Length B Feet (m)	Labels Per Roll
Fig. 3	J20C-1125-2569	B-2569	Polyester	White	1.125 (28.57)	100 (30.5)	1 cont.
Fig. 3	J20C-2250-2569	B-2569	Polyester	White	2.250 (57.15)	100 (30.5)	1 cont.
Fig. 3	J20C-4000-2569	B-2569	Polyester	White	4.000 (101.6)	100 (30.5)	1 cont.
Fig. 3	J20C-1125-2595	B-2595	Vinyl	White	1.125 (28.57)	100 (30.5)	1 cont.
Fig. 3	J20C-2250-2595	B-2595	Vinyl	White	2.250 (57.15)	100 (30.5)	1 cont.
Fig. 3	J20C-4000-2595	B-2595	Vinyl	White	4.000 (101.6)	100 (30.5)	1 cont.

Non-adhesive Tagstock

Figure	Catalog #	B#	Material	Color	Label Width A Inch (mm)	Tag Length B Inch (mm)	Tags Per Roll
Fig. 13	J20-255-2551	B-2551	Tagstock	White	3.250 (82.55)	5.750 (146.05)	100
Fig. 3	J20C-3250-2551	B-2551	Tagstock	White	3.250 (82.55)	50 ft (15.24 m)	1 cont.
Fig. 3	J20C-2500-2551	B-2551	Tagstock	White	2.500 (63.50)	50 ft (15.24 m)	1 cont.

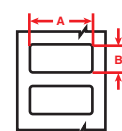

Figure 2

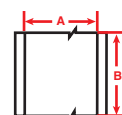

Figure 3

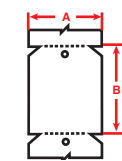

Figure 13

Benchtop Printers

J2000

BradyJet J5000 Color Label Printer

BradyID.com/s36

Benchmark Printers



BRADY360
1 YEAR
WARRANTY

BradyJet J5000

COLOR LABEL PRINTER

High-resolution, high-speed full-color label creation

Get the impactful color labels you need to create a safer, more efficient workplace. The BradyJet J5000 Color Label Printer is an on-demand, inkjet solution for creating photo-quality color labels for indoor use in a single pass, while reducing your inventory of labeling supplies and material waste.

- 4,800 dpi print resolution for high-resolution clarity and fine detail
- Full-color photo reproduction and wide tonal range allows for labels with photos, graphics, illustrations, text, linear and 2D bar codes
- More than 16 million color possibilities with only 4 ink cartridges
- Large ink cartridges that reduce the amount of changeovers or replacements
- Fast print speeds up to 6 inches per second
- Print up to 5,000 high resolution labels per day, using only the ink and label materials needed to keep waste and inventory down
- Variety of label options with 2 to 8 inch wide continuous and die-cut materials

Learn more at BradyID.com/J5000

Printer at-a-glance

- Full-color CMYK inkjet printing
- High-resolution print ideal for photos
- Large output up to 8 in. wide
- PC-connect only
- 18 parts, 2 materials

Printing supplies

J50-series labels rolls.....page 88
J50-series Ink cartridges.....page 88



Catalog #	Description
J5000	BradyJet J5000 Color Label Printer*

* Printer ships with printhead with set-up ink cartridges, set-up CD, USB cable, power cord, Quick Start Guide.



Easy to load supplies can be changed in seconds.

J5000

High-resolution and full-color identification throughout your facility



Safety signage



Asset management



Pipe marking



GHS hazcomm



Standard work / dance chart



Photo signage and more

BradyJet J5000 Color Label Printer

BradyID.com/s36

Printer specifications

Description	8 in. PC-connect printer with high-resolution, high-speed color label printing. Ideal for creating full-color labels with images, logos, illustrations, barcodes and more. The ultimate in high-resolution printing in all colors
Applications	Arc flash labels (w/ red variables), equipment labels, GHS labels, pipe markers, safety signs and warning labels (multi-color), lean / 5S labels, multi-color labels, lock labels (w/ photos), asset management, department signage, finished goods
Label material types	Inkjet receptive topcoated vinyl and polyester
Types of labels	Continuous and die-cut labels
Print technology	Thermal inkjet
Print resolution	Up to 4800 dpi
Max print width	4 in.
Media widths	2 to 8 in.
Minimum label size	2 in.
Color printing capabilities	Full color process; up to 16.7 million colors
Auto cut-off	Yes
X-Y plotter cutting	No
PC-connect or standalone operation	PC-connect only
Connectivity options	USB, Ethernet and wireless
Compatible software	Brady Workstation Apps
Compatible materials	J50 series (all)
Calibration required	Required only on initial setup
Ink and label roll installation	Labels: Supplied as rolls, 20-second changeover Ink: Supplied as cartridge, 10-second changeover
Warranty	1 year*

*See BradyID.com/brady360 for full coverage details and restrictions.



Brady Workstation Safety and Facility ID Suite

Brady Workstation has revolutionized how you design and print labels from your PC. When paired with the high-performance printing capabilities of a Brady printer, you get intuitive label set up for simple, efficient and flexible label creation.

This suite features:

- A collection of applications for creating the custom signs, labels and pipe markers you need to add visual safety guidance to your facility
- The ability to serialize and import your data onto the labels
- Real-time information about the label material installed, enabling easy label set up
- Built-in regulations, standards, pictograms, common phrases, data importation guidance, help functions and more

▶ Learn more on page 176 or download a free trial at Workstation.BradylD.com

Full-color printing means less material to inventory

Three white BradyJet J5000 label rolls can create the same types of labels as these 14 colored and pre-printed rolls.

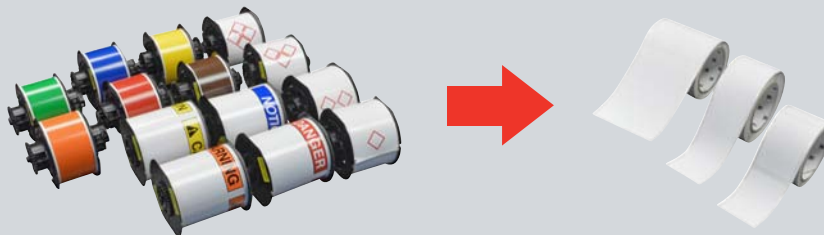

Benchtop Printers

J5000

BradyJet J5000 Label Materials

BradyID.com/s36

BradyJet J5000 Label Materials

BradyJet J5000 label materials feature a topcoat that enhances the colors and label appearance, and protects your print from smudging and harsh conditions. These labels have been tested to withstand exposure to liquids, alcohol and chemicals, as well as indoor fluorescent and UV lighting. Custom sizes of B-2595 and B-2569 available.



Benchmark Printers

Die-cut Labels

Figure	Catalog #	B#	Material	Color	Label Width A Inch (mm)	Roll Length B Inch (mm)	Labels Per Roll
Fig. 2	J50-260-2595	B-2595	Vinyl	White	3.35 (85.0)	2.17 (55.0)	340
Fig. 2	J50-261-2595	B-2595	Vinyl	White	4.33 (110.0)	2.95 (75.0)	270
Fig. 2	J50-262-2595	B-2595	Vinyl	White	6.10 (155.0)	4.13 (105.0)	200
Fig. 2	J50-267-2595	B-2595	Vinyl	White	8.30 (210.8)	6.10 (154.9)	120
Fig. 2	J50-265-2595	B-2595	Vinyl	White	10.00 (254.0)	7.00 (177.8)	100
Fig. 2	J50-260-2569	B-2569	Polyester	White	3.35 (85.0)	2.17 (55.0)	340
Fig. 2	J50-261-2569	B-2569	Polyester	White	4.33 (110.0)	2.95 (75.0)	270
Fig. 2	J50-262-2569	B-2569	Polyester	White	6.10 (155.0)	4.13 (105.0)	200
Fig. 2	J50-267-2569	B-2569	Polyester	White	8.30 (210.8)	6.10 (154.9)	120
Fig. 2	J50-265-2569	B-2569	Polyester	White	10.00 (254.0)	7.00 (177.8)	100

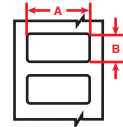

Figure 2

Continuous Tapes

Figure	Catalog #	B#	Material	Color	Label Width A Inch (mm)	Roll Length B Feet (m)	Labels Per Roll
Fig. 3	J50C-2250-2595	B-2595	Vinyl	White	2.25 (57.5)	100 (30.5)	1 cont.
Fig. 3	J50C-4000-2595	B-2595	Vinyl	White	4.00 (101.6)	100 (30.5)	1 cont.
Fig. 3	J50C-6000-2595	B-2595	Vinyl	White	6.00 (152.4)	100 (30.5)	1 cont.
Fig. 3	J50C-8000-2595	B-2595	Vinyl	White	8.00 (203.2)	100 (30.5)	1 cont.
Fig. 3	J50C-2250-2569	B-2569	Polyester	White	2.25 (57.5)	100 (30.5)	1 cont.
Fig. 3	J50C-4000-2569	B-2569	Polyester	White	4.00 (101.6)	100 (30.5)	1 cont.
Fig. 3	J50C-6000-2569	B-2569	Polyester	White	6.00 (152.4)	100 (30.5)	1 cont.
Fig. 3	J50C-8000-2569	B-2569	Polyester	White	8.00 (203.2)	100 (30.5)	1 cont.

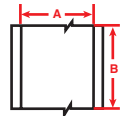

Figure 3

Non-adhesive Tag Stock

Figure	Catalog #	B#	Material	Color	Label Width A Inch (mm)	Roll Length B Inch (mm)	Tags Per Roll
Fig. 13	J50-255-2551	B-2551	Vinyl Tag	White	3.250 (82.6)	5.750 (146.1)	100

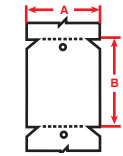

Figure 13

Clear Acrylic Overlaminates (B-910)

- Clear acrylic film with permanent adhesive provides improved label durability including outdoor UV resistance up to 3 years
- Hand apply after label is applied to surface
- Overlaminates is slightly wider than BradyJet continuous tape



Catalog #	B#	Color	Roll Width Inch (mm)	Roll Length Feet (m)
149259	B-910	Clear	2.75 (69.9)	120 (36.6)
149258	B-910	Clear	4.5 (114.3)	120 (36.6)
149257	B-910	Clear	6.5 (165.1)	120 (36.6)
149260	B-910	Clear	8.5 (215.9)	120 (36.6)

BradyJet J5000 Ink Cartridges

Catalog #	Description
J50-CY	Cyan
J50-MA	Magenta
J50-YL	Yellow
J50-BK	Black — cartridge contains double the volume as colors
J50-CMYK	Multi-pack — 1 each of cyan, magenta, yellow, black cartridges



J5000

Creating On-Demand Rigid Signs

Rigid Sign Blanks

Create your own rigid signs using printed output from your Brady printer and rigid sign panels.

Three mounding techniques to choose from:

- Mount label to a rigid sign panel using the label's pressure sensitive adhesive
- Use the BLS1255 Laminating System to laminate output to a rigid sign panel
- Mount label behind a clear acrylic sign panel using the panel's included pressure sensitive adhesive



Aluminum panels

Catalog #	Material	Color	Height (inch)	Length (inch)	Qty
146083	Alum.	Wht	2.500	6.260	10
146113	Alum.	Wht	2.500	10.250	10
13629	Alum.	Wht	4.250	6.250	10
106461	Alum.	Wht	4.250	10.250	10
146082	Alum.	Wht	4.250	14.250	10
13632	Alum.	Wht	7.250	10.250	10
106460	Alum.	Wht	7.630	10.380	10
106462	Alum.	Wht	10.250	10.250	10
13635	Alum.	Wht	10.250	14.250	10
146116	Alum.	Ylw	2.500	6.260	10
146117	Alum.	Ylw	2.500	10.250	10
13630	Alum.	Ylw	4.250	6.250	10
146114	Alum.	Ylw	4.250	10.250	10
146115	Alum.	Ylw	4.250	14.250	10
13633	Alum.	Ylw	7.625	10.375	10
13636	Alum.	Ylw	10.250	14.250	10
13631	Alum.	Org	4.250	6.250	10
13634	Alum.	Org	7.625	10.375	10
15Y885	Alum.	Org	10.250	14.250	10

Plastic panels

Catalog #	Material	Color	Height (inch)	Length (inch)	Qty
146076	Plastic	Wht	2.500	6.250	10
146077	Plastic	Wht	2.500	10.250	10
13620	Plastic	Wht	4.250	6.250	10
146074	Plastic	Wht	4.250	10.250	10
146075	Plastic	Wht	4.250	14.250	10
13623	Plastic	Wht	7.630	10.380	10
146080	Plastic	Ylw	2.500	6.250	10
146081	Plastic	Ylw	2.500	10.250	10
13621	Plastic	Ylw	4.250	6.250	10
146078	Plastic	Ylw	4.250	10.250	10
146079	Plastic	Ylw	4.250	14.250	10
13622	Plastic	Org	4.250	6.250	10
13625	Plastic	Org	7.630	10.380	10
13628	Plastic	Org	10.250	14.250	10

Clear acrylic panels

Includes pressure sensitive adhesive backing to mount output behind the clear panel — protecting the graphics

Catalog #	Material	Color	Height (inch)	Length (inch)	Qty
13638	Acrylic	Clear	4.000	6.000	10
106464	Acrylic	Clear	4.250	10.250	10
13639	Acrylic	Clear	7.250	10.000	10
106463	Acrylic	Clear	7.250	10.250	10
13640	Acrylic	Clear	10.000	14.000	10
106465	Acrylic	Clear	10.25 in.	10.25 in.	10

BLS1255 Laminating System

BLS1255 laminator enables you to quickly and easily make custom rigid signs for your facility

- Mount signs to rigid panels to create signs for your facility
- Fast and easy to use
- No heat or electricity needed
- Laminate documents up to 12 in. wide



Catalog #	Description
105038	BLS1255 Laminating System
105041	12 in. x 50 ft. Double-Sided Polyester Overlamine



Laminates documents up to 12 in. wide

MiniMark™ Label Materials

BradyID.com/s36



The MiniMark printer has been discontinued, but Brady continues to manufacture and stock labels and ribbons for the printer.



Benchmark Printers

Indoor / Outdoor Grade Vinyl (B-595)

- Conforms well to irregular, curved, rough and highly textured surfaces
- 8-10 year average outdoor durability in temperatures from -40° F to 180° F. Labels can be applied in temperatures from 0° F to 180° F
- Patent Number D481.414



Figure 33b



	0.500 in. x 100 ft. (12.7 mm x 30.48 m)	1.125 in. x 100 ft. (28.6 mm x 30.48 m)	2.250 in. x 100 ft. (57.2 mm x 30.48 m)	3.000 in. x 100 ft. (76.2 mm x 30.48 m)	4.000 in. x 100 ft. (101.6 mm x 30.48 m)	Rec. Ribbon
White	113186	113185	113184	113183	113182	103025
Yellow	113195	113194	113193	113192	113191	103025
Red	113199	113198	113197	-	113196	103026
Blue	113211	113210	113209	-	113208	103026
Green	113207	113206	113205	-	113204	103026
Black	113215	113214	113213	-	113212	103026
Brown	115762	115761	115760	-	115759	103026
Gold	-	115757	115756	-	115755	103025
Grey	115754	115753	113219	-	113218	103025
Purple	115752	115751	113217	-	113216	103026
Orange	113203	113202	113201	-	113200	103025
Clear	113190	113189	113188	-	113187	103025

General Purpose Indoor / Outdoor Vinyl (B-7569)

- Excellent for facility, safety, chemical and lean 5S labeling
- Five year average outdoor durability in temperatures from -40° F to 180° F. Labels can be applied in temperatures from 0° F to 180° F
- Patent Number D481.414



Figure 33b



	1.125 in. x 110 ft. (28.6 mm x 30.48 m)	2.250 in. x 110 ft. (57.2 mm x 30.48 m)	4.000 in. x 110 ft. (101.6 mm x 30.48 m)	Rec. Ribbon
White	120847	120854	120861	52042
Yellow	120848	120855	120862	52042
Red	120849	120856	120863	52042
Orange	120852	120859	120866	52042
Blue	120851	120858	120865	52044
Green	120850	120857	120864	52044
Black	120853	120860	120867	52044

MiniMark

Pre-Printed Header Stripe Supply for Arc Flash Labels and Signs (B-595)

- Pre-printed continuous stripe on top portion, then supply is cut-to-length according to length of text entered

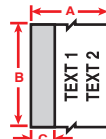

Figure 71



Diagram	Catalog #	Material	Stripe Color	Label Height A Inch (mm)	Roll Length B Feet (m)	Stripe Width C Inch (mm)	Labels Per Roll	Rec. Ribbon
Fig. 71	113221	B-595	Red	4.000 (101.6)	100 (30.48)	1.000 (25.4)	1 roll (cont.)	103025
Fig. 71	113230	B-595	Red	2.250 (57.15)	100 (30.48)	0.500 (12.7)	1 roll (cont.)	103025
Fig. 71	113222	B-595	Orange	4.000 (101.6)	100 (30.48)	1.000 (25.4)	1 roll (cont.)	103025
Fig. 71	113227	B-595	Orange	3.000 (76.2)	100 (30.48)	0.750 (19.05)	1 roll (cont.)	103025
Fig. 71	113228	B-595	Orange	2.250 (57.15)	100 (30.48)	0.500 (12.7)	1 roll (cont.)	103025
Fig. 71	113220	B-595	Yellow	4.000 (101.6)	100 (30.48)	1.000 (25.4)	1 roll (cont.)	103025
Fig. 71	113226	B-595	Yellow	3.000 (76.2)	100 (30.48)	0.750 (19.05)	1 roll (cont.)	103025
Fig. 71	113229	B-595	Yellow	2.250 (57.15)	100 (30.48)	0.500 (12.7)	1 roll (cont.)	103025

Tamper-Evident Metallized Polyester (B-438)

- Permanent adhesive
- Tape destructs into tiny fragments when tampered with, making removal very tedious and difficult

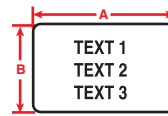

Figure 29



Diagram	Catalog #	Material	Color	Label Width A Inch (mm)	Label Height B Inch (mm)	Labels Per Row	Labels Per Roll	Rec. Ribbon
Fig. 29	52148	B-438	Silver	2.000 (50.8)	1.000 (25.4)	1	1,240	103025
Fig. 29	52149	B-438	Silver	3.000 (76.2)	1.000 (25.4)	1	1,225	103025
Fig. 29	52150	B-438	Silver	3.000 (76.2)	2.000 (50.8)	1	650	103025
Fig. 29	52152	B-438	Silver	3.000 (76.2)	110 ft. (33.5 m)	-	1 roll (cont.)	103025



MiniMark Print Ribbons

Ribbons for B-595 and B-438 materials

Catalog #	Roll Size	Color	Rolls Per Pack
103026	4 in. x 290 ft.	White	2
103025	4 in. x 290 ft.	Black	2

Ribbons for B-7569 material

Catalog #	Roll Size	Color	Rolls Per Pack
52044	4.4 in. x 290 ft.	White	2
52042	4.4 in. x 290 ft.	Black	2
52045	4.4 in. x 290 ft.	Red	2
52059	4.4 in. x 290 ft.	Green	2
52047	4.4 in. x 290 ft.	Blue	2

GlobalMark® Label Materials

BradyID.com/s36

GLOBALMARK[®] 2 INDUSTRIAL LABEL MAKER

The GlobalMark printer has been discontinued, but Brady continues to manufacture and stock labels and accessories for the printer.



GlobalMark2 Printer Accessories

Catalog #	Description
120994	Rolling case w/ handle and supplies pockets for benchtop printers
STYLUS-3PK	Stylus Pens (3/pk)
64MB-CF	256MB Memory Card
76811	Replacement Cutting Blade
76737	Transfer Tape (4.25 in. x 300 ft.)
20596	Grommets for Tags (100/pk)
20591	Hole Punch for Tags
81762	7 in. Nylon Cable Ties (100/pk)

Benchtop Printers

Pre-Printed Blank Sign Headers (B-595)

- Allows printer to create multicolor signs fast - in a single print pass
- Headers meet NFPA 70E, OSHA 1910.145 and ASME / ANSI Z535 standards
- Indoor / outdoor grade material conforms to rough, highly textured, and "difficult to adhere to" surfaces

Service temp: -40°F to 180°F; Application temp: 0°F to 180°F
Average Outdoor Durability: 8-10 years

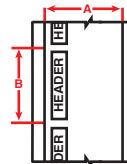

Figure 73



Diagram	Catalog #	B#	Header	Label Height A Inch (mm)	Label Width B Inch (mm)	Labels Per Row	Labels Per Roll	Rec. Ribbon
Fig. 73	121550	B-595		2.250 (57.2)	3.250 (82.6)	1	270	76739
Fig. 73	121558	B-595		4.000 (101.6)	6.250 (158.8)	1	165	76739
Fig. 73	121552	B-595		2.250 (57.2)	3.250 (82.6)	1	270	76739
Fig. 73	121560	B-595		4.000 (101.6)	6.250 (158.8)	1	165	76739
Fig. 73	121551	B-595		2.250 (57.2)	3.250 (82.6)	1	270	76739
Fig. 73	121559	B-595		4.000 (101.6)	6.250 (158.8)	1	165	76739
Fig. 73	121549	B-595		2.250 (57.2)	3.250 (82.6)	1	270	76739
Fig. 73	121557	B-595		4.000 (101.6)	6.250 (158.8)	1	165	76739
Fig. 73	121553	B-595		2.250 (57.2)	3.250 (82.6)	1	270	76739
Fig. 73	121561	B-595		4.000 (101.6)	6.250 (158.8)	1	165	76739
Fig. 73	121554	B-595		2.250 (57.2)	3.250 (82.6)	1	270	76739
Fig. 73	121562	B-595		4.000 (101.6)	6.250 (158.8)	1	165	76739
Fig. 73	121563	B-595		1.125 (28.6) *	2.750 (69.8)	1	300	76739
Fig. 73	121547	B-595		2.250 (57.2)	3.250 (82.6)	1	270	76739
Fig. 73	121564	B-595		2.250 (57.2) *	3.750 (95.2)	1	250	76739
Fig. 73	121555	B-595		4.000 (101.6)	6.250 (158.8)	1	165	76739
Fig. 73	121548	B-595		2.250 (57.2)	3.250 (82.6)	1	270	76739
Fig. 73	121556	B-595		4.000 (101.6)	6.250 (158.8)	1	165	76739

*Pre-sized to fit blank rigid valve tags below, but can also be used as general purpose label.

GlobalMark



Blank Rigid Valve Tags

- Die-cut labels are sized to fit the recessed area on the tag
- Outdoor tag withstands temperatures -40° F to 180° F

Blank rigid valve tags

Catalog #	Color	Tag Size Inch	Recessed Area Inch
87696	White	2.1 x 3.6	1.5 x 3
87697	White	3.1 x 4.6	2.5 x 4
41922	Yellow	2.1 x 3.6	1.5 x 3
41923	Yellow	3.1 x 4.6	2.5 x 4
41924	Red	2.1 x 3.6	1.5 x 3
41925	Red	3.1 x 4.6	2.5 x 4
41926	Blue	2.1 x 3.6	1.5 x 3
41927	Blue	3.1 x 4.6	2.5 x 4
41928	Green	2.1 x 3.6	1.5 x 3
41929	Green	3.1 x 4.6	2.5 x 4
87694	Orange	2.1 x 3.6	1.5 x 3
87695	Orange	3.1 x 4.6	2.5 x 4

Catalog #	Color	Tag Size Inch	Recessed Area Inch
87712	Tan	2.1 x 3.6	1.5 x 3
87713	Tan	3.1 x 4.6	2.5 x 4
87710	Brown	2.1 x 3.6	1.5 x 3
87711	Brown	3.1 x 4.6	2.5 x 4
87698	Gray	2.1 x 3.6	1.5 x 3
87699	Gray	3.1 x 4.6	2.5 x 4
41920	Black	2.1 x 3.6	1.5 x 3
41921	Black	3.1 x 4.6	2.5 x 4
142133	Variety Pack*		

* Pack of 30 tags includes at least one of each size and color. Perfect for evaluating which sizes and colors you need.

Non-Adhesive and Pre-Cut Safety Tags (B-551)

- Non-adhesive semi rigid card stock with perforations between tags
 - Tags are pre-cut with hole and chamfered corners
 - Snap-in plastic grommets available for extra strength around mounting hole
- Service temp: -40°F to 193°F; Average Outdoor Durability: up to 2 years*

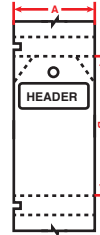

Diagram	Catalog #	B#	Header	Tag Width A Inch (mm)	Tag Height B Inch (mm)	Tags Per Row	Tags Per Roll	Rec. Ribbon
Fig. 69	121543	B-551		3.250 (82.6)	5.750 (146.1)	1	100	76739
Fig. 69	121544	B-551		3.250 (82.6)	5.750 (146.1)	1	100	76739
Fig. 69	121545	B-551		3.250 (82.6)	5.750 (146.1)	1	100	76739
Fig. 69	121546	B-551		3.250 (82.6)	5.750 (146.1)	1	100	76739

Right-to-Know Labels (B-595)

- Outdoor grade vinyl adhesive label in Color Bar or NFPA 704M diamond formats
- 4-color diamond or bars are pre-printed so that labels only require 1-color print pass (black) through the printer



Catalog #	B#	Legend	Label Width Inch (mm)	Label Height Inch (mm)	Labels Per Row	Labels Per Pkg	Rec. Ribbon
115763	B-595		4.000 (101.6)	6.250 (158.8)	1	170	96089
115766	B-595		2.250 (57.2)	4.000 (101.6)	1	240	96089
115772	B-595		2.250 (57.2)	2.250 (57.2)	1	365	96089
115765	B-595		4.000 (101.6)	4.000 (101.6)	1	240	96089
115773	B-595		2.250 (57.2)	2.250 (57.2)	1	365	96089
115764	B-595		4.000 (101.6)	6.250 (158.8)	1	170	96089
115767	B-595		2.250 (57.2)	4.000 (101.6)	1	240	96089
115771	B-595		2.250 (57.2)	2.250 (57.2)	1	365	96089
115768	B-595		2.250 (57.2)	2.250 (57.2)	1	365	96089
115770	B-595		1.125 (28.6)	3.000 (76.2)	1	300	96089
115769	B-595		1.125 (28.6)	3.000 (76.2)	1	300	96089

Overlaminates for RTK Labels (B-674)

Protect your printed labels with a pressure sensitive polyester overlaminates.

Catalog #	B#	Color	Label Width Inch (mm)	Label Height Inch (mm)	Labels Per Pkg
64984	B-674	Clear	1.500 (38.1)	2.500 (63.5)	50
58476	B-674	Clear	2.500 (63.5)	2.500 (63.5)	50
58706	B-674	Clear	3.500 (88.9)	5.500 (139.7)	50
64985	B-674	Clear	4.500 (114.3)	6.500 (165.1)	50

GlobalMark® Label Materials

BradyID.com/s36

Indoor / Outdoor Grade Vinyl Tape (B-595)

- Conforms well to irregular, curved, rough and highly textured surfaces
- Low-shrink vinyl minimizes the amount of unsightly dust and grime buildup often found around the edges of other vinyl labeling supplies
- 8-10 year average outdoor durability in temperatures from -40° F to 180° F (-40° C to 82° C). Labels can be applied in temperatures from 0° F to 180° F

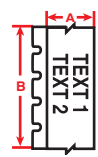

Figure 33



Benchtop Printers

GlobalMark

Diagram	Catalog #	B#	Color	Label Width A Inch (mm)	Roll Length B Feet (m)	Labels Per Roll	Rec. Ribbon
Fig. 33	113109	B-595	White	4.000 (101.6)	100 (30.5)	1 roll (cont.)	76739
Fig. 33	113110	B-595	White	3.000 (76.2)	100 (30.5)	1 roll (cont.)	76739
Fig. 33	113111	B-595	White	2.250 (57.2)	100 (30.5)	1 roll (cont.)	76739
Fig. 33	113112	B-595	White	1.125 (28.6)	100 (30.5)	1 roll (cont.)	76739
Fig. 33	113113	B-595	White	0.500 (12.7)	100 (30.5)	1 roll (cont.)	76739
Fig. 33	113114	B-595	Yellow	4.000 (101.6)	100 (30.5)	1 roll (cont.)	76739
Fig. 33	113115	B-595	Yellow	3.000 (76.2)	100 (30.5)	1 roll (cont.)	76739
Fig. 33	113116	B-595	Yellow	2.250 (57.2)	100 (30.5)	1 roll (cont.)	76739
Fig. 33	113117	B-595	Yellow	1.125 (28.6)	100 (30.5)	1 roll (cont.)	76739
Fig. 33	113118	B-595	Yellow	0.500 (12.7)	100 (30.5)	1 roll (cont.)	76739
Fig. 33	113119	B-595	Red	4.000 (101.6)	100 (30.5)	1 roll (cont.)	76741
Fig. 33	113120	B-595	Red	2.250 (57.2)	100 (30.5)	1 roll (cont.)	76741
Fig. 33	113121	B-595	Red	1.125 (28.6)	100 (30.5)	1 roll (cont.)	76741
Fig. 33	113122	B-595	Red	0.500 (12.7)	100 (30.5)	1 roll (cont.)	76741
Fig. 33	113127	B-595	Blue	4.000 (101.6)	100 (30.5)	1 roll (cont.)	76741
Fig. 33	113128	B-595	Blue	2.250 (57.2)	100 (30.5)	1 roll (cont.)	76741
Fig. 33	113129	B-595	Blue	1.125 (28.6)	100 (30.5)	1 roll (cont.)	76741
Fig. 33	113130	B-595	Blue	0.500 (12.7)	100 (30.5)	1 roll (cont.)	76741
Fig. 33	113123	B-595	Green	4.000 (101.6)	100 (30.5)	1 roll (cont.)	76741
Fig. 33	113124	B-595	Green	2.250 (57.2)	100 (30.5)	1 roll (cont.)	76741
Fig. 33	113125	B-595	Green	1.125 (28.6)	100 (30.5)	1 roll (cont.)	76741
Fig. 33	113126	B-595	Green	0.500 (12.7)	100 (30.5)	1 roll (cont.)	76741
Fig. 33	113131	B-595	Black	4.000 (101.6)	100 (30.5)	1 roll (cont.)	76741
Fig. 33	113132	B-595	Black	2.250 (57.2)	100 (30.5)	1 roll (cont.)	76741
Fig. 33	113133	B-595	Black	1.125 (28.6)	100 (30.5)	1 roll (cont.)	76741
Fig. 33	113134	B-595	Black	0.500 (12.7)	100 (30.5)	1 roll (cont.)	76741
Fig. 33	113135	B-595	Brown	4.000 (101.6)	100 (30.5)	1 roll (cont.)	76741
Fig. 33	113136	B-595	Brown	2.250 (57.2)	100 (30.5)	1 roll (cont.)	76741
Fig. 33	113137	B-595	Brown	1.125 (28.6)	100 (30.5)	1 roll (cont.)	76741
Fig. 33	113138	B-595	Brown	0.500 (12.7)	100 (30.5)	1 roll (cont.)	76741
Fig. 33	113139	B-595	Gold	4.000 (101.6)	100 (30.5)	1 roll (cont.)	76739
Fig. 33	113140	B-595	Gold	2.250 (57.2)	100 (30.5)	1 roll (cont.)	76739
Fig. 33	113141	B-595	Gold	1.125 (28.6)	100 (30.5)	1 roll (cont.)	76739
Fig. 33	113142	B-595	Gold	0.500 (12.7)	100 (30.5)	1 roll (cont.)	76739
Fig. 33	113143	B-595	Grey	4.000 (101.6)	100 (30.5)	1 roll (cont.)	76739
Fig. 33	113144	B-595	Grey	2.250 (57.2)	100 (30.5)	1 roll (cont.)	76739
Fig. 33	113145	B-595	Grey	1.125 (28.6)	100 (30.5)	1 roll (cont.)	76739
Fig. 33	113146	B-595	Grey	0.500 (12.7)	100 (30.5)	1 roll (cont.)	76739
Fig. 33	113147	B-595	Purple	4.000 (101.6)	100 (30.5)	1 roll (cont.)	76741
Fig. 33	113148	B-595	Purple	2.250 (57.2)	100 (30.5)	1 roll (cont.)	76741
Fig. 33	113149	B-595	Purple	1.125 (28.6)	100 (30.5)	1 roll (cont.)	76741
Fig. 33	113150	B-595	Purple	0.500 (12.7)	100 (30.5)	1 roll (cont.)	76741
Fig. 33	113151	B-595	Orange	4.000 (101.6)	100 (30.5)	1 roll (cont.)	76739
Fig. 33	113152	B-595	Orange	2.250 (57.2)	100 (30.5)	1 roll (cont.)	76739
Fig. 33	113153	B-595	Orange	1.125 (28.6)	100 (30.5)	1 roll (cont.)	76739
Fig. 33	113154	B-595	Orange	0.500 (12.7)	100 (30.5)	1 roll (cont.)	76739
Fig. 33	113105	B-595	Clear	4.000 (101.6)	100 (30.5)	1 roll (cont.)	76739
Fig. 33	113106	B-595	Clear	2.250 (57.2)	100 (30.5)	1 roll (cont.)	76739
Fig. 33	113107	B-595	Clear	1.125 (28.6)	100 (30.5)	1 roll (cont.)	76739
Fig. 33	113108	B-595	Clear	0.500 (12.7)	100 (30.5)	1 roll (cont.)	76739

Polyester Tape (B-569)

- Continuous outdoor grade polyester
- Best choice for marking stainless steel pipes and surfaces (low halide content)
- Ultra-smooth finish excellent for mounting to rigid panels and very smooth surfaces
- Applies best to very smooth surfaces



Figure 33



Diagram	Catalog #	B#	Color	Label Width A Inch (mm)	Roll Length B Feet (m)	Labels Per Roll	Rec. Ribbon
Fig.33	76614	B-569	White	4.000 (101.6)	100 (30.5)	1 roll (cont.)	76739
Fig.33	76615	B-569	White	3.000 (76.2)	100 (30.5)	1 roll (cont.)	76739
Fig.33	76616	B-569	White	2.250 (57.2)	100 (30.5)	1 roll (cont.)	76739
Fig.33	76617	B-569	White	1.125 (28.6)	100 (30.5)	1 roll (cont.)	76739
Fig.33	76618	B-569	White	0.500 (12.7)	100 (30.5)	1 roll (cont.)	76739
Fig.33	76619	B-569	Yellow	4.000 (101.6)	100 (30.5)	1 roll (cont.)	76739
Fig.33	76620	B-569	Yellow	2.250 (57.2)	100 (30.5)	1 roll (cont.)	76739
Fig.33	76621	B-569	Yellow	1.125 (28.6)	100 (30.5)	1 roll (cont.)	76739
Fig.33	76622	B-569	Yellow	0.500 (12.7)	100 (30.5)	1 roll (cont.)	76739
Fig.33	76623	B-569	Red	4.000 (101.6)	100 (30.5)	1 roll (cont.)	76741
Fig.33	76624	B-569	Red	2.250 (57.2)	100 (30.5)	1 roll (cont.)	76741
Fig.33	76625	B-569	Red	1.125 (28.6)	100 (30.5)	1 roll (cont.)	76741
Fig.33	76626	B-569	Red	0.500 (12.7)	100 (30.5)	1 roll (cont.)	76741
Fig.33	76627	B-569	Blue	4.000 (101.6)	100 (30.5)	1 roll (cont.)	76741
Fig.33	76628	B-569	Blue	2.250 (57.2)	100 (30.5)	1 roll (cont.)	76741
Fig.33	76629	B-569	Blue	1.125 (28.6)	100 (30.5)	1 roll (cont.)	76741
Fig.33	76630	B-569	Blue	0.500 (12.7)	100 (30.5)	1 roll (cont.)	76741
Fig.33	76639	B-569	Green	4.000 (101.6)	100 (30.5)	1 roll (cont.)	76741
Fig.33	76640	B-569	Green	2.250 (57.2)	100 (30.5)	1 roll (cont.)	76741
Fig.33	76641	B-569	Green	1.125 (28.6)	100 (30.5)	1 roll (cont.)	76741
Fig.33	76642	B-569	Green	0.500 (12.7)	100 (30.5)	1 roll (cont.)	76741
Fig.33	76647	B-569	Black	4.000 (101.6)	100 (30.5)	1 roll (cont.)	76741
Fig.33	76648	B-569	Black	2.250 (57.2)	100 (30.5)	1 roll (cont.)	76741
Fig.33	76649	B-569	Black	1.125 (28.6)	100 (30.5)	1 roll (cont.)	76741
Fig.33	76650	B-569	Black	0.500 (12.7)	100 (30.5)	1 roll (cont.)	76741
Fig.33	76643	B-569	Brown	4.000 (101.6)	100 (30.5)	1 roll (cont.)	76741
Fig.33	76644	B-569	Brown	2.250 (57.2)	100 (30.5)	1 roll (cont.)	76741
Fig.33	76645	B-569	Brown	1.125 (28.6)	100 (30.5)	1 roll (cont.)	76741
Fig.33	76646	B-569	Brown	0.500 (12.7)	100 (30.5)	1 roll (cont.)	76741
Fig.33	76602	B-569	Tan	4.000 (101.6)	100 (30.5)	1 roll (cont.)	76739
Fig.33	76603	B-569	Tan	2.250 (57.2)	100 (30.5)	1 roll (cont.)	76739
Fig.33	76604	B-569	Tan	1.125 (28.6)	100 (30.5)	1 roll (cont.)	76739
Fig.33	76651	B-569	Grey	4.000 (101.6)	100 (30.5)	1 roll (cont.)	76739
Fig.33	76652	B-569	Grey	2.250 (57.2)	100 (30.5)	1 roll (cont.)	76739
Fig.33	76653	B-569	Grey	1.125 (28.6)	100 (30.5)	1 roll (cont.)	76739
Fig.33	76654	B-569	Grey	0.500 (12.7)	100 (30.5)	1 roll (cont.)	76739
Fig.33	76631	B-569	Purple	4.000 (101.6)	100 (30.5)	1 roll (cont.)	76741
Fig.33	76632	B-569	Purple	2.250 (57.2)	100 (30.5)	1 roll (cont.)	76741
Fig.33	76633	B-569	Purple	1.125 (28.6)	100 (30.5)	1 roll (cont.)	76741
Fig.33	76634	B-569	Purple	0.500 (12.7)	100 (30.5)	1 roll (cont.)	76741
Fig.33	76635	B-569	Orange	4.000 (101.6)	100 (30.5)	1 roll (cont.)	76739
Fig.33	76636	B-569	Orange	2.250 (57.2)	100 (30.5)	1 roll (cont.)	76739
Fig.33	76637	B-569	Orange	1.125 (28.6)	100 (30.5)	1 roll (cont.)	76739
Fig.33	76638	B-569	Orange	0.500 (12.7)	100 (30.5)	1 roll (cont.)	76739
Fig.33	76598	B-569	Pink	4.000 (101.6)	100 (30.5)	1 roll (cont.)	76739
Fig.33	76599	B-569	Pink	2.250 (57.2)	100 (30.5)	1 roll (cont.)	76739
Fig.33	76600	B-569	Pink	1.125 (28.6)	100 (30.5)	1 roll (cont.)	76739
Fig.33	76601	B-569	Pink	0.500 (12.7)	100 (30.5)	1 roll (cont.)	76739
Fig.33	76606	B-569	Lt. Blue	4.000 (101.6)	100 (30.5)	1 roll (cont.)	76741
Fig.33	76607	B-569	Lt. Blue	2.250 (57.2)	100 (30.5)	1 roll (cont.)	76741
Fig.33	76608	B-569	Lt. Blue	1.125 (28.6)	100 (30.5)	1 roll (cont.)	76741
Fig.33	76609	B-569	Lt. Blue	0.500 (12.7)	100 (30.5)	1 roll (cont.)	76741
Fig.33	97738	B-569	Ochre	4.000 (101.6)	100 (30.5)	1 roll (cont.)	76739
Fig.33	97739	B-569	Ochre	2.250 (57.2)	100 (30.5)	1 roll (cont.)	76739
Fig.33	97740	B-569	Ochre	1.125 (28.6)	100 (30.5)	1 roll (cont.)	76739
Fig.33	97741	B-569	Ochre	0.500 (12.7)	100 (30.5)	1 roll (cont.)	76739
Fig.33	97742	B-569	Sky Blue	4.000 (101.6)	100 (30.5)	1 roll (cont.)	76739
Fig.33	97743	B-569	Sky Blue	2.250 (57.2)	100 (30.5)	1 roll (cont.)	76739
Fig.33	97744	B-569	Sky Blue	1.125 (28.6)	100 (30.5)	1 roll (cont.)	76739
Fig.33	97745	B-569	Sky Blue	0.500 (12.7)	100 (30.5)	1 roll (cont.)	76739
Fig.33	76610	B-569	Clear	4.000 (101.6)	100 (30.5)	1 roll (cont.)	76739
Fig.33	76611	B-569	Clear	2.250 (57.2)	100 (30.5)	1 roll (cont.)	76739
Fig.33	76612	B-569	Clear	1.125 (28.6)	100 (30.5)	1 roll (cont.)	76739
Fig.33	76613	B-569	Clear	0.500 (12.7)	100 (30.5)	1 roll (cont.)	76739

ToughStripe® Print-On-Demand Floor Labels (B-483)

- Revolutionary B-483 material has ultra aggressive adhesive
- Withstands forklift and pallet jack traffic without tearing or lifting
- Easy 3-step process: print label, position on floor, apply overlaminates
- Each roll ships with a roll of clear overlaminate which must be applied over printed label and onto appropriate surface for best performance
- Plotter-cutting shapes and text not allowed with this material



Figure 33



Diagram	Catalog #	B#	Color	Label Width A Inch (mm)	Roll Length B Feet (m)	Labels Per Roll	Rec. Ribbon
Fig. 33	142155	B-483	White	1.125 (28.6)	100 (30.5)	1 roll (cont.)	76739
Fig. 33	142154	B-483	White	2.250 (57.2)	100 (30.5)	1 roll (cont.)	76739
Fig. 33	142156	B-483	White	3.000 (76.2)	100 (30.5)	1 roll (cont.)	76739
Fig. 33	142157	B-483	White	4.000 (101.6)	100 (30.5)	1 roll (cont.)	76739
Fig. 33	142162	B-483	Yellow	1.125 (28.6)	100 (30.5)	1 roll (cont.)	76739
Fig. 33	142161	B-483	Yellow	2.250 (57.2)	100 (30.5)	1 roll (cont.)	76739
Fig. 33	142163	B-483	Yellow	3.000 (76.2)	100 (30.5)	1 roll (cont.)	76739
Fig. 33	142164	B-483	Yellow	4.000 (101.6)	100 (30.5)	1 roll (cont.)	76741
Fig. 33	142166	B-483	Red	1.125 (28.6)	100 (30.5)	1 roll (cont.)	76741
Fig. 33	142165	B-483	Red	2.250 (57.2)	100 (30.5)	1 roll (cont.)	76741
Fig. 33	142167	B-483	Red	4.000 (101.6)	100 (30.5)	1 roll (cont.)	76741
Fig. 33	142169	B-483	Blue	1.125 (28.6)	100 (30.5)	1 roll (cont.)	76741
Fig. 33	142168	B-483	Blue	2.250 (57.2)	100 (30.5)	1 roll (cont.)	76741
Fig. 33	142170	B-483	Blue	4.000 (101.6)	100 (30.5)	1 roll (cont.)	76741
Fig. 33	142172	B-483	Green	1.125 (28.6)	100 (30.5)	1 roll (cont.)	76739
Fig. 33	142171	B-483	Green	2.250 (57.2)	100 (30.5)	1 roll (cont.)	76739
Fig. 33	142173	B-483	Green	4.000 (101.6)	100 (30.5)	1 roll (cont.)	76739
Fig. 33	142159	B-483	Black	1.125 (28.6)	100 (30.5)	1 roll (cont.)	76741
Fig. 33	142158	B-483	Black	2.250 (57.2)	100 (30.5)	1 roll (cont.)	76741
Fig. 33	142160	B-483	Black	4.000 (101.6)	100 (30.5)	1 roll (cont.)	76741
Fig. 33	142175	B-483	Orange	1.125 (28.6)	100 (30.5)	1 roll (cont.)	76739
Fig. 33	142174	B-483	Orange	2.250 (57.2)	100 (30.5)	1 roll (cont.)	76739
Fig. 33	142176	B-483	Orange	4.000 (101.6)	100 (30.5)	1 roll (cont.)	76739

Phosphorescent Tape (B-526)

- Permanent adhesive and glows in darkness for 10 hours
- Glows brighter and longer than B-582
- Complies with indoor use requirements specified in RS 6-1 and 6-1A of New York Local Law 26
- Plotter-cutting shapes and text not allowed with this material



Figure 33



Diagram	Catalog #	B#	Color	Label Width A Inch (mm)	Roll Length B Feet (m)	Labels Per Roll	Rec. Ribbon
Fig. 33	105909	B-526	Phosphorescent	4.000 (101.6)	50 (15.2)	1 roll (cont.)	76739, 76743
Fig. 33	105910	B-526	Phosphorescent	2.250 (57.2)	50 (15.2)	1 roll (cont.)	76739, 76743
Fig. 33	105911	B-526	Phosphorescent	1.125 (28.6)	50 (15.2)	1 roll (cont.)	76739, 76743

Phosphorescent Tape (B-582)

- Permanent adhesive and glows in darkness for hours
- Meets ISO, and ASTM standards
- Plotter-cutting shapes and text not allowed with this material



Figure 33



Diagram	Catalog #	B#	Color	Label Width A Inch (mm)	Roll Length B Feet (m)	Labels Per Roll	Rec. Ribbon
Fig. 33	76711	B-582	Phosphorescent	4.000 (101.6)	50 (15.2)	1 roll (cont.)	76739, 76743
Fig. 33	76712	B-582	Phosphorescent	2.250 (57.2)	50 (15.2)	1 roll (cont.)	76739, 76743
Fig. 33	76713	B-582	Phosphorescent	1.125 (28.6)	50 (15.2)	1 roll (cont.)	76739, 76743

ToughWash® Tape (B-854, B-855)

- Withstands pressures of high heat, harsh chemicals and numerous washdown cycles
- B-854 offers metal detectable layer to detect foreign debris in food stream
- Ideal for use in the Food and Beverage industry
- Plotter-cutting shapes and text not allowed with this material

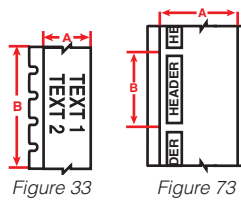

Diagram	Catalog #	B#	Legend	Label Width A Inch (mm)	Length B Inch (mm)	Labels Per Roll	Rec. Ribbon
B-854 ToughWash Metal Detectable Material							
Fig. 33	133134	B-854		4.000 (101.06)	50 ft. (15.2 m)	1 roll (cont.)	134352
Fig. 33	133133	B-854		4.000 (101.06)	50 ft. (15.2 m)	1 roll (cont.)	134352
Fig. 73	133141	B-854		4.000 (101.06)	6.250 (158.8)	100	134352
Fig. 73	133140	B-854		4.000 (101.06)	6.250 (158.8)	100	134352
Fig. 73	139812	B-854		4.000 (101.06)	6.250 (158.8)	100	134352
Fig. 73	133139	B-854		4.000 (101.06)	6.250 (158.8)	100	134352
B-855 ToughWash Material							
Fig. 33	133159	B-855		4.000 (101.06)	50 ft. (15.2 m)	1 roll (cont.)	134352
Fig. 33	133158	B-855		4.000 (101.06)	50 ft. (15.2 m)	1 roll (cont.)	134352
Fig. 73	133166	B-855		4.000 (101.06)	6.250 (158.8)	100	134352
Fig. 73	133165	B-855		4.000 (101.06)	6.250 (158.8)	100	134352
Fig. 73	139811	B-855		4.000 (101.06)	6.250 (158.8)	100	134352
Fig. 73	133164	B-855		4.000 (101.06)	6.250 (158.8)	100	134352

Reflective Tape (B-584)

- Permanent adhesive / outdoor grade
- Shines back at viewer brightly when light shines on label
- Plotter-cutting shapes and text not allowed with this material

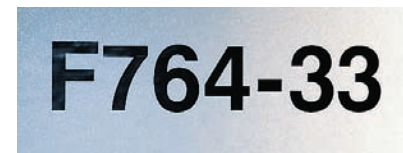

Diagram	Catalog #	B#	Color	Label Width A Inch (mm)	Roll Length B Feet (m)	Labels Per Roll	Rec. Ribbon
Fig. 33	76705	B-584	Silver	4.000 (101.6)	50 (15.2)	1 roll (cont.)	76739
Fig. 33	76706	B-584	Silver	2.250 (57.2)	50 (15.2)	1 roll (cont.)	76739
Fig. 33	76707	B-584	Silver	1.125 (28.6)	50 (15.2)	1 roll (cont.)	76739
Fig. 33	96060	B-584	Yellow	4.000 (101.6)	50 (15.2)	1 roll (cont.)	76739
Fig. 33	96061	B-584	Yellow	2.250 (57.2)	50 (15.2)	1 roll (cont.)	76739
Fig. 33	96062	B-584	Yellow	1.125 (28.6)	50 (15.2)	1 roll (cont.)	76739
Fig. 33	99219	B-584	Orange	4.000 (101.6)	50 (15.2)	1 roll (cont.)	76739
Fig. 33	99220	B-584	Orange	2.250 (57.2)	50 (15.2)	1 roll (cont.)	76739
Fig. 33	99221	B-584	Orange	1.125 (28.6)	50 (15.2)	1 roll (cont.)	76739

Tag Stock Material (B-551)

- Non-adhesive tag stock meets OSHA 50 lb. pull requirement
- Grommets and hole punch available
- Plotter-cutting shapes and text not allowed with this material



Diagram	Catalog #	B#	Color	Label Width A Inch (mm)	Roll Length B Feet (m)	Labels Per Roll	Rec. Ribbon
Fig. 33	76714	B-551	White	4.250 (107.9)	50 (15.2)	1 roll (cont.)	76739
Fig. 33	76715	B-551	White	3.250 (82.5)	50 (15.2)	1 roll (cont.)	76739
Fig. 33	76716	B-551	White	2.500 (63.5)	50 (15.2)	1 roll (cont.)	76739

Repositionable Vinyl Tape (B-581)

- Special adhesive allows you to easily remove the label and re-apply
- Ideal for indoor marking where frequent repositioning is required
- Plotter-cutting shapes and text not allowed with this material



Figure 33



Diagram	Catalog #	B#	Color	Label Width A Inch (mm)	Roll Length B Feet (m)	Labels Per Roll	Rec. Ribbon
Fig. 33	76697	B-581	White	4.000 (101.6)	100 (30.5)	1 roll (cont.)	76739
Fig. 33	76698	B-581	White	2.250 (57.2)	100 (30.5)	1 roll (cont.)	76739
Fig. 33	76699	B-581	White	1.125 (28.6)	100 (30.5)	1 roll (cont.)	76739
Fig. 33	76700	B-581	White	0.500 (12.7)	100 (30.5)	1 roll (cont.)	76739
Fig. 33	76701	B-581	Yellow	4.000 (101.6)	100 (30.5)	1 roll (cont.)	76739
Fig. 33	76702	B-581	Yellow	2.250 (57.2)	100 (30.5)	1 roll (cont.)	76739
Fig. 33	76703	B-581	Yellow	1.125 (28.6)	100 (30.5)	1 roll (cont.)	76739
Fig. 33	76704	B-581	Yellow	0.500 (12.7)	100 (30.5)	1 roll (cont.)	76739

Magnetic Tape (B-509)

- Non-adhesive
- Print directly onto magnetic material
- Plotter-cutting shapes and text not allowed with this material



Figure 33



Diagram	Catalog #	B#	Color	Label Width A Inch (mm)	Roll Length B Feet (m)	Labels Per Roll	Rec. Ribbon
Fig. 33	76686	B-509	White	4.000 (101.6)	25 (7.62)	1 roll (cont.)	76739
Fig. 33	76687	B-509	White	2.500 (63.5)	25 (7.62)	1 roll (cont.)	76739
Fig. 33	76688	B-509	Yellow	4.000 (101.6)	25 (7.62)	1 roll (cont.)	76739
Fig. 33	76689	B-509	Yellow	2.500 (63.5)	25 (7.62)	1 roll (cont.)	76739

Cold Temperature Tape (B-549)

- Permanently adheres to surfaces at temperatures as low as -10°F
- Great for use in any cold storage warehouse, cooler or freezer
- Plotter-cutting shapes and text not allowed with this material



Figure 33

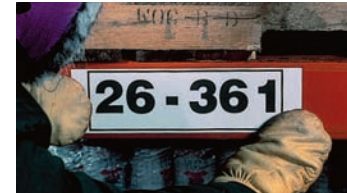

Diagram	Catalog #	B#	Color	Label Width A Inch (mm)	Roll Length B Feet (m)	Labels Per Roll	Rec. Ribbon
Fig. 33	76691	B-549	White	4.250 (107.9)	100 (30.5)	1 roll (cont.)	76739
Fig. 33	76692	B-549	White	2.500 (63.5)	100 (30.5)	1 roll (cont.)	76739
Fig. 33	76693	B-549	White	1.375 (34.9)	100 (30.5)	1 roll (cont.)	76739
Fig. 33	76694	B-549	Yellow	4.000 (101.6)	100 (30.5)	1 roll (cont.)	76739
Fig. 33	76695	B-549	Yellow	2.500 (63.5)	100 (30.5)	1 roll (cont.)	76739
Fig. 33	76696	B-549	Yellow	1.375 (34.9)	100 (30.5)	1 roll (cont.)	76739

Metallized Polyester Tape (B-565)

- Permanent adhesive
- Non-cutttable supply suitable for continuous-style labels
- Cuttable supply ideal for multi-up, cut labels in basic rectangular and round shapes only. Not suitable for cut-out text or intricate shapes.



Figure 33



Diagram	Catalog #	B#	Color	Label Width A Inch (mm)	Roll Length B Feet (m)	Labels Per Roll	Rec. Ribbon
Fig. 33	76720	B-565	Non-cutttable Metallized	4.250 (107.9)	100 (30.5)	1 roll (cont.)	76739
Fig. 33	76721	B-565	Non-cutttable Metallized	2.500 (63.5)	100 (30.5)	1 roll (cont.)	76739
Fig. 33	76722	B-565	Non-cutttable Metallized	1.375 (34.9)	100 (30.5)	1 roll (cont.)	76739
Fig. 33	114533	B-565	Cutttable Metallized	4.250 (107.9)	100 (30.5)	1 roll (cont.)	76739

Transfer Tape For Cut Text

- Leaves cut characters pre-spaced for transferring from liner to the desired surface

Diagram	Catalog #	Label Width A Inch (mm)	Roll Length B Feet (m)
Fig. 33	76737	4.250 (107.9)	300 ft. (91.44 m)



Example of a Single Color Ribbon

Examples of Multi-Color Paneled Ribbons

GlobalMark2 Industrial Print Ribbons

- Super-tough smear-proof ribbons assure your printed text lasts for years outdoors and in an industrial environment
- Ribbons ship self-contained in cartridges that drop straight in the printer with a click
- No calibrating, threading, wasted feeding, hassles and the ink will always be facing the right direction
- 2- and 4-color paneled ribbons are used to print labels and signs containing more than 1 print color
- Patent D481,755

Single Color Print Ribbons

Catalog #	Color	Size Inch (mm)	Length
76739	Black	4.110 (104.4)	200 (60.9)
134352	Black (for use with B-854 and B-855 ToughWash® material only)	4.110 (104.4)	200 (60.9)
96089	Black (for use with RTK labels)	4.110 (104.4)	200 (60.9)
76741	White	4.110 (104.4)	200 (60.9)
76743	Red	4.110 (104.4)	200 (60.9)
76745	Blue	4.110 (104.4)	200 (60.9)
76747	Green	4.110 (104.4)	200 (60.9)
76749	Magenta	4.110 (104.4)	200 (60.9)
76751	Yellow	4.110 (104.4)	200 (60.9)
76752	Orange	4.110 (104.4)	200 (60.9)
76759	Process Cyan	4.110 (104.4)	200 (60.9)
76760	Process Yellow	4.110 (104.4)	200 (60.9)
76761	Process Magenta	4.110 (104.4)	200 (60.9)

Two Color Print Ribbons

Catalog #	Color	Size Inch (mm)	Length
Panels: 4.110 x 8.000 (104.4 x 203.2 mm)			
Typical yield: 100 labels (8 in.) from 8 in. paneled ribbon			
76739	Black	4.110 x 8.000 (104.4 x 203.2 mm) panels	200 (60.9)
76763	Black and Red	4.110 x 8.000 (104.4 x 203.2 mm) panels	200 (60.9)
110220	Red and Green	4.110 x 8.000 (104.4 x 203.2 mm) panels	200 (60.9)
76775	Black and Blue	4.110 x 8.000 (104.4 x 203.2 mm) panels	200 (60.9)
76767	Black and Yellow	4.110 x 8.000 (104.4 x 203.2 mm) panels	200 (60.9)
76771	Black and Orange	4.110 x 8.000 (104.4 x 203.2 mm) panels	200 (60.9)
76779	Black and Green	4.110 x 8.000 (104.4 x 203.2 mm) panels	200 (60.9)
Panels: 4.110 x 16.000 (104.4 x 406.4 mm)			
Typical yield: 60 labels (16 in.) from 16 in. paneled ribbon			
76762	Black and Red	4.110 x 16.000 (104.4 x 406.4 mm) panels	200 (60.9)
76774	Black and Blue	4.110 x 16.000 (104.4 x 406.4 mm) panels	200 (60.9)
76766	Black and Yellow	4.110 x 16.000 (104.4 x 406.4 mm) panels	200 (60.9)
76770	Black and Orange	4.110 x 16.000 (104.4 x 406.4 mm) panels	200 (60.9)
76778	Black and Green	4.110 x 16.000 (104.4 x 406.4 mm) panels	200 (60.9)
76782	Red and Blue	4.110 x 16.000 (104.4 x 406.4 mm) panels	200 (60.9)

Four Color Print Ribbons

Catalog #	Color	Size Inch (mm)	Length
Panels: 4.110 x 8.000 (104.4 x 203.2 mm)			
Typical yield: 50 labels (8 in.) from 8 in. paneled ribbon			
76787	Black, Red, Blue and Green	4.110 x 8.000 (104.4 x 203.2 mm) panels	200 (60.9)
110221	Red, Green, Yellow and Black	4.110 x 8.000 (104.4 x 203.2 mm) panels	200 (60.9)
76791	Black, Red, Blue and Yellow	4.110 x 8.000 (104.4 x 203.2 mm) panels	200 (60.9)
76795	Cyan, Magenta, Yellow and Black	4.110 x 8.000 (104.4 x 203.2 mm) panels	200 (60.9)
51447	Black, Red, Orange and Blue	4.110 x 8.000 (104.4 x 203.2 mm) panels	200 (60.9)
Panels: 4.110 x 16.000 (104.4 x 406.4 mm)			
Typical yield: 30 labels (16 in.) from 16 in. paneled ribbon			
76786	Black, Red, Blue and Green	4.110 x 16.000 (104.4 x 406.4 mm) panels	200 (60.9)
76790	Black, Red, Blue and Yellow	4.110 x 16.000 (104.4 x 406.4 mm) panels	200 (60.9)
76794	Cyan, Magenta, Yellow and Black	4.110 x 16.000 (104.4 x 406.4 mm) panels	200 (60.9)

Labelizer® Plus and VersaPrinter™ Supplies

BradyID.com/s36

The Labelizer PLUS and VersaPrinter have been discontinued, but for a limited time Brady will continue to stock labels for these printers.



Labelizer® Plus Industrial Labeling System



VersaPrinter™ Label and Sign Maker

Indoor / Outdoor Vinyl Tape with Ribbon (B-595)

- Conforms well to irregular, curved or rough surfaces
 - Ideal for general purpose industrial uses – stands up to grease, oil and most industrial chemicals
- 8-10 year average outdoor durability in temperatures from 180° F to -40° F (82° C to -40° C).
Can be applied as low as 0° F (-18° C)



Catalog #	B#	Ribbon and Tape Color	Label Width A Inch (mm)	Roll Length B Feet (m)	Tape Cartridges Per Pkg. (Ribbon included in cartridge)
142760	B-595	Black on Clear	0.500 (12.7)	90 (27.4)	2
142759	B-595	Black on Clear	1.125 (28.6)	90 (27.4)	2
142758	B-595	Black on Clear	2.250 (57.2)	90 (27.4)	1
142757	B-595	Black on Clear	4.000 (101.6)	90 (27.4)	1
142762	B-595	White on Clear	2.250 (57.2)	90 (27.4)	1
142765	B-595	Black on Green	1.125 (28.6)	90 (27.4)	2
142764	B-595	Black on Green	2.250 (57.2)	90 (27.4)	1
142763	B-595	Black on Green	4.000 (101.6)	90 (27.4)	1
142750	B-595	Black on Yellow	0.500 (12.7)	90 (27.4)	2
142749	B-595	Black on Yellow	1.125 (28.6)	90 (27.4)	2
142748	B-595	Black on Yellow	2.250 (57.2)	90 (27.4)	1
142747	B-595	Black on Yellow	3.000 (76.2)	90 (27.4)	1
142746	B-595	Black on Yellow	4.000 (101.6)	90 (27.4)	1
142769	B-595	White on Green	0.500 (12.7)	90 (27.4)	2
142768	B-595	White on Green	1.125 (28.6)	90 (27.4)	2
142767	B-595	White on Green	2.250 (57.2)	90 (27.4)	1
142766	B-595	White on Green	4.000 (101.6)	90 (27.4)	1
142777	B-595	White on Blue	0.500 (12.7)	90 (27.4)	2
142776	B-595	White on Blue	1.125 (28.6)	90 (27.4)	2
142775	B-595	White on Blue	2.250 (57.2)	90 (27.4)	1
142774	B-595	White on Blue	4.000 (101.6)	90 (27.4)	1
142772	B-595	White on Red	0.500 (12.7)	90 (27.4)	2
142773	B-595	White on Red	1.125 (28.6)	90 (27.4)	2
142771	B-595	White on Red	2.250 (57.2)	90 (27.4)	1
142770	B-595	White on Red	4.000 (101.6)	90 (27.4)	1
142756	B-595	Black on Orange	0.500 (12.7)	90 (27.4)	2
142755	B-595	Black on Orange	1.125 (28.6)	90 (27.4)	2
142754	B-595	Black on Orange	2.250 (57.2)	90 (27.4)	1
142753	B-595	Black on Orange	4.000 (101.6)	90 (27.4)	1
142785	B-595	Black on Gray	0.500 (12.7)	90 (27.4)	2
142784	B-595	Black on Gray	1.125 (28.6)	90 (27.4)	2
142783	B-595	Black on Gray	2.250 (57.2)	90 (27.4)	1
142782	B-595	Black on Gray	4.000 (101.6)	90 (27.4)	1
142793	B-595	White on Brown	1.125 (28.6)	90 (27.4)	2
142792	B-595	White on Brown	2.250 (57.2)	90 (27.4)	1
142791	B-595	White on Brown	4.000 (101.6)	90 (27.4)	1
142787	B-595	White on Tan	1.125 (28.6)	90 (27.4)	2
142786	B-595	White on Tan	2.250 (57.2)	90 (27.4)	1
142790	B-595	White on Magenta	1.125 (28.6)	90 (27.4)	2
142789	B-595	White on Magenta	2.250 (57.2)	90 (27.4)	1
142788	B-595	White on Magenta	4.000 (101.6)	90 (27.4)	1
142781	B-595	White on Black	0.500 (12.7)	90 (27.4)	2
142780	B-595	White on Black	1.125 (28.6)	90 (27.4)	2
142779	B-595	White on Black	2.250 (57.2)	90 (27.4)	1
142778	B-595	White on Black	4.000 (101.6)	90 (27.4)	1

Benchmark Printers

Labelizer Plus

Low-Halide Polyester Tape (B-569)

- Specially designed with a low halide content – best choice for use on stainless steel and nickel piping and other smooth surfaces
- 8-10 year average outdoor durability in temperatures from 180° F to -40° F (82° C to -40° C) and can be applied as low as 0° F (-18° C)



Catalog #	B#	Ribbon and Tape Color	Label Width A Inch (mm)	Roll Length B Feet (m)	Tape Cartridges Per Pkg. (Ribbon included in cartridge)
64347	B-569	Black on Clear	1.125 (28.6)	110 (33.5)	2
64348	B-569	Black on Clear	2.250 (57.2)	110 (33.5)	1
64349	B-569	Black on Clear	4.000 (101.6)	110 (33.5)	1
64331	B-569	White on Green	1.125 (28.6)	110 (33.5)	2
64332	B-569	White on Green	2.250 (57.2)	110 (33.5)	1
64333	B-569	White on Green	4.000 (101.6)	110 (33.5)	1
64335	B-569	White on Blue	1.125 (28.6)	110 (33.5)	2
64336	B-569	White on Blue	2.250 (57.2)	110 (33.5)	1
64339	B-569	White on Red	1.125 (28.6)	110 (33.5)	2
64340	B-569	White on Red	2.250 (57.2)	110 (33.5)	1
64355	B-569	Black on White	1.125 (28.6)	110 (33.5)	2
64356	B-569	Black on White	2.250 (57.2)	110 (33.5)	1
64357	B-569	Black on White	4.000 (101.6)	110 (33.5)	1

Reflective Tape (B-584)

- Reflective capabilities are ideal for reading labels in low light areas both indoors and out

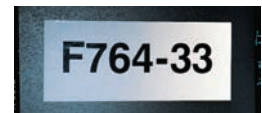

Catalog #	B#	Ribbon and Tape Color	Label Width A Inch (mm)	Roll Length B Feet (m)	Tape Cartridges Per Pkg. (Ribbon included in cartridge)
64739	B-584	Black on White	1.125 (28.6)	75 (22.8)	2
64740	B-584	Black on White	2.250 (57.2)	75 (22.8)	1
64741	B-584	Black on White	4.000 (101.6)	75 (22.8)	1
64401	B-584	Black on Orange	2.250 (57.2)	58 (17.7)	1
64402	B-584	Black on Orange	4.000 (101.6)	75 (22.8)	1
64403	B-584	Black on Yellow	1.125 (28.6)	69 (21.0)	2
64404	B-584	Black on Yellow	2.250 (57.2)	58 (17.7)	1
64405	B-584	Black on Yellow	4.000 (101.6)	75 (22.8)	1

Overlaminates (B-674)

- Hand apply overlaminate after label is applied for improved label durability



Catalog #	B#	Ribbon and Tape Color	Label Width A Inch (mm)	Roll Length B Feet (m)	Cartridges Per Pkg.
25966	B-674	Clear	0.750 (19.05)	30 (9.1)	1
25967	B-674	Clear	1.375 (34.9)	30 (9.1)	1
25968	B-674	Clear	2.500 (63.5)	30 (9.1)	1
25969	B-674	Clear	4.250 (107.9)	30 (9.1)	1

Repositionable Vinyl Tape (B-581)

- Special adhesive allows easy removal of label with reapplication again and again
- Ideal for indoor use where frequent repositioning is required, such as storage shelves



Catalog #	B#	Ribbon and Tape Color	Label Width A Inch (mm)	Roll Length B Feet (m)	Tape Cartridges Per Pkg. (Ribbon included in cartridge)
64731	B-581	Black on White	1.125 (28.6)	90 (27.4)	2
64732	B-581	Black on White	2.250 (57.2)	90 (27.4)	1
64733	B-581	Black on White	4.000 (101.6)	90 (27.4)	1
64735	B-581	Black on Yellow	1.125 (28.6)	90 (27.4)	2
64736	B-581	Black on Yellow	2.250 (57.2)	90 (27.4)	1
64737	B-581	Black on Yellow	4.000 (101.6)	90 (27.4)	1

Portable Printer Comparison Guide



BMP®21-PLUS Label Printer
See page 104



BMP®41 Label Printer
See page 108



BMP®51 Label Printer
See page 114

Overview	Basic labels on continuous supply for wires and cables, panels, datacomm, as well as misc. industrial labels in operations, maintenance and production areas. 0.75 inch maximum width.	Labels with more advanced text and formatting on die-cut and continuous supplies for wires and cables, electrical and automation panels and datacomm, as well as misc. industrial labels in operations, maintenance and production areas. 1 inch maximum width.	Labels with more advanced text and formatting on die-cut and continuous supplies for wires and cables, electrical and automation panels and datacomm, as well as misc. industrial labels in operations, maintenance and production areas. 1.5 inch maximum width.
Printer specifications			
Print speed	0.40 in. / sec.	1.30 in. / sec.	1.18 in. / sec. (w/ AC adapter)
Print and color capabilities	Thermal Transfer / Monochrome	Thermal Transfer / Monochrome	Thermal Transfer / Monochrome
Print resolution	203 dpi	300 dpi	300 dpi
PC compatibility or standalone	Standalone	Standalone and PC connect	Standalone and PC connect
Connectivity options	None	USB	USB / Wi-Fi (field-installable), LAN
Software compatibility	None	Brady Workstation Apps, LabelMark™ Software,	Brady Workstation Apps, Brady Mobile Apps w/ Wi-Fi card, LabelMark™ Software
Power supply options	Li-Ion rechargeable battery, 6AA, AC adapter	NiMH rechargeable battery, AC adapter	Li-Ion rechargeable battery, 8AA, AC adapter
Standard warranty	2 years	2 years	2 years
Dimensions	4.5 in. W x 9.5 in. H x 2.5 in. D	6.0 in. W x 11.5 in. H x 3.6 in. D	6.0 in. W x 10.3 in. H x 3.6 in. D
Weight	1.04 lbs. (w/o tape, batteries)	2.1 lbs. (w/o tape, batteries)	2.6 lbs. (w/o tape, batteries)
Print features			
Screen size	3 lines x 14 characters	13 lines x 36 characters	13 lines x 36 characters
Backlit screen	Yes	Yes	Yes
Keyboard style	ABC	QWERTY	QWERTY
Max print width	0.75 in.	1.0 in.	1.5 in.
Font types available	(1) Brady Alpine	(2) Brady Alpine and Brady Fixed Width	(2) Brady Alpine and Brady Fixed Width
Font sizes (pts)	Auto, 6, 9, 14, 20, 28, 40	Custom, auto, 4, 6, 7, 9, 10, 13, 14, 16, 20, 26, 28, 32, 38, 40, 42, 45, 51, 55, 60, 65	Custom, auto, 4, 6, 7, 9, 10, 13, 14, 16, 20, 26, 28, 32, 38, 40, 42, 45, 51, 55, 60, 65, 70, 76, 102
Multi-line label capabilities	4	25	32
Label print rotation	Yes	Yes	Yes
Data serialization	Alphanumeric	Yes, multiple and linked	Yes, multiple and linked
Barcode capabilities and types	Code 39, Code 128, QR and Data Matrix	Code 39, Code 128 and more using Brady Workstation	Code 39, Code 128 and more using Brady Workstation
Memory capacity	10 files up to 2 MB	25,000 characters up to 48 MB	25,000 characters up to 48 MB
Data transfer from PC	No	Yes	Yes
Print preview	No	Yes	Yes
Symbols available	193	450	450
Label supplies			
Label / ribbon supply	Cartridge w/ included ribbon	Cartridge w/ included ribbon	Cartridge w/ included ribbon
Material formats supported	Continuous labels only	Continuous and die-cut labels	Continuous and die-cut labels
Media width	0.25 in. to 0.75 in.	0.25 in. to 1.0 in.	0.25 in. to 1.5 in.
Types of materials	Outdoor vinyl, nylon cloth wire ID, heat-shrink wire ID, self-laminating wire ID, standard polyester, chemical resistant polyester	Outdoor vinyl, nylon cloth wire ID, heat-shrink wire ID, self-laminating wire ID, removable cloth wire ID, standard polyester, aggressive adhesive polyester, metallized polyester, non-adhesive tag, outdoor reflective	Outdoor vinyl, nylon cloth wire ID, heat-shrink wire ID, self-laminating wire ID, removable cloth wire ID, datacomm cable tags, standard polyester, aggressive adhesive polyester, metallized polyester, non-adhesive tag, outdoor reflective
Quantity of label parts available	70+ label parts	100+ label parts	200+ label parts
Cartridge series	M21-series	M-series up to 1 in. wide	M-series

new



BradyPrinter M611 Mobile Label Printer
See page 126



BMP®61 Label Printer
See page 128



BMP®71 Label Printer
See page 152

Overview	Higher volumes of labels with more advanced text and formatting on die-cut and continuous supplies for wire and cable, electrical and automation panels, datacomm and general ID. Runs on external Brady Workstation mobile or desktop software. Features a color touchscreen with material monitoring, Wi-Fi and Bluetooth connectivity, USB 2.0 port. 2 in. maximum width.	Higher volumes of labels with more advanced text and formatting on die-cut and continuous supplies for wire and cable, electrical and automation panels, datacomm and general ID. Features a color touch screen, QWERTY keyboard, USB connectivity, optional Wi-Fi, list management. 2 in. maximum width.	Higher volumes of labels with more advanced text and formatting on die-cut and continuous supplies for wires and cables, electrical and automation panels and datacomm, as well as misc. industrial labels in operations, maintenance and production areas. 2 inch maximum width.
Printer specifications			
Print speed	1.33 in. / sec.	1.33 in. / sec	1.5 in. / sec
Print and color capabilities	Thermal Transfer / Monochrome	Thermal Transfer / Monochrome	Thermal Transfer / Monochrome
Print resolution	300 dpi	300 dpi	300 dpi
PC compatibility or standalone	Peripheral only, no keyboard	Standalone and PC connect	Standalone and PC connect
Connectivity options	Bluetooth, Wi-Fi, USB 2.0	USB / Wi-Fi (factory installed)	USB Port B
Software compatibility	Required. Brady Workstation Express Labels Mobile App (IOS / Android) or Brady Workstation Desktop	Brady Workstation Apps, Brady Mobile Apps w/ Wi-Fi model, LabelMark™ (6.0 or higher)	Brady Workstation Apps, LabelMark™ Software
Power supply options	Rechargeable Li-Ion, AC power / battery charger / car charger	Rechargeable NiMH battery, AC power / battery charger	NiMH battery, AC adapter
Standard warranty	2 years	2 years	2 years
Dimensions	10.974 in. L x 4.459 in. W x 4.553 in. H	12.93 in. L x 4.22 in. W x 4.19 in. H	9.5 in. W x 13.0 in. H x 4.6 in. D
Weight	3.52 lbs. (with supplied media and ribbon)	2.46 lbs. (w/o tape, batteries)	4.9 lbs. (w/o tape, batteries)
Print features			
Screen size	Custom LCD, color, 3.5 in. QVGA	Touchscreen, LCD, Color, 2.8 in. QVGA	LCD, Color, 3.5 in. QVGA
Backlit screen	Yes	Yes	Yes
Keyboard style	None	QWERTY	QWERTY, Number Keypad
Max print width	1.92 in.	1.92 in.	1.92 in.
Font types available	Driven by software	(2) Brady Alpine and Brady Fixed Width	(2) Brady Alpine and Brady Fixed Width
Font sizes (pts)	Driven by software	4 through 174, autosizing	4 through 174, autosizing
Multi-line label capabilities	Driven by software	25	25
Label print rotation	Driven by software	Yes	Yes
Data serialization	Driven by software	Yes, multiple and linked	Yes, multiple and linked
Barcode capabilities and types	Driven by software	Code 39, Code 128 and more using Brady Workstation	Code 39, Code 128 and more using Brady Workstation
Memory capacity	512 MB RAM / 256 MB Flash	512 MB RAM / 256 MB Flash	200 MB
Data transfer from PC	Driven by software	Yes	Yes
Print preview	No	Yes	Yes
Symbols available	Driven by software	450	500+
Label supplies			
Label / ribbon supply	Separate label roll and ribbon cartridges	Separate label roll and ribbon cartridges	Separate label roll and ribbon cartridges
Material formats supported	Continuous, die-cut labels and custom	Continuous, die-cut labels and custom	Continuous, die-cut labels and custom
Media width	0.235 to 2.00 in.	0.235 to 2.00 in.	0.235 to 2.00 in.
Types of materials	General purpose industrial vinyl, heat-shrink wire ID, self-laminating wire ID, removable cloth wire ID, datacomm cable tags, standard polyester, aggressive adhesive polyester, metallized polyester non-adhesive tag, polyimide / electronics materials, tamper resistant materials, raised panel labels (engraved plate alternative)	General purpose industrial vinyl, heat-shrink wire ID, self-laminating wire ID, removable cloth wire ID, datacomm cable tags, standard polyester, aggressive adhesive polyester, metallized polyester, non-adhesive tag, polyimide /electronics materials, tamper resistant materials, raised panel labels (engraved plate alternative)	Outdoor vinyl, nylon cloth wire ID, heat-shrink wire ID, self-laminating wire ID, removable cloth wire ID, tedlar wire ID, datacomm cable tags, standard polyester, aggressive adhesive polyester, metallized polyester, non-adhesive tag, polyimide / electronics materials, tamper resistant materials, outdoor reflective, glow-in-the-dark, ToughStripe floor tape, ToughWash, repositionable vinyl, raised panel labels (engraved plate alternative)
Quantity of label parts available	600+ label parts and customs	600+ label parts and customs	300+ label parts and customs
Cartridge series	BPTL, BPTDS, BPSPT, BPTLTB, PTL, PSHT, PTLEP, PTS, PTLFP, PSPT, PTPSL, PSFR, PTPS, PTLSL, BM71, BM61, M61, M61C, custom available	BPTL, BPTDS, BPSPT, BPTLTB, PTL, PSHT, PTLEP, PTS, PTLFP, PSPT, PTPSL, PSFR, PTPS, PTLSL, BM71, BM61, M61, M61C, custom available	M71 series, BM71, PTL series with adapter and some BMP61 labels with adapter (TLS and BMP61 ribbons not compatible)

BMP®21-PLUS Printer

BradyID.com/s36



BRADY360
2 YEAR
WARRANTY

Portable Printers

BMP21-PLUS

BMP®21-PLUS LABEL PRINTER

Tough on the outside Smart on the inside

- Automatic label formatting for wire wraps, patch panels, terminal blocks, cable flags, circuit breaker arrays and general banner labels
- Drop-lock-and-print materials
- Passed shock and vibration testing per MIL-STD-810G Method 5.16.6 S4.6.5
- Optional rechargeable Li-Ion battery
- Continuous-only supplies in 0.25 in. to 0.75 in. widths
- 70+ label parts 10 materials types
- Label grabber holds label after cutting
- 193 symbols for electric, smart home, safety and datacomm
- 2-year warranty

▶ Watch the demo video at BradyID.com/bmp21plus

Your complete printing solution:

BMP21-PLUS cartridges with label and print ribbon page 105

BMP21-PLUS Label Printer and Accessories

Catalog #	Description
BMP21-PLUS	BMP21-PLUS Label Printer*
BMP21-PLUS-KIT1	BMP21-PLUS Label Printer Kit**
BMP21-MAGNET	Magnet Accessory
BMP21-TOOL	Multi-functional Tool Accessory (magnet / flashlight / retractable stand)
M-AC-110937	AC Power Adapter / Charger
BMP21-PLUS-BATT	Li-Ion Battery Pack
BMP21-PLUS-HC	Hard Case
BMP-SC-1	Soft Case

* Printer includes label cartridge, lanyard, quick start guide and 2-year warranty (batteries not included).

** Printer kit includes: printer, label cartridge, Li-Ion battery, AC power / charger, hard case, lanyard, quick start guide and 2-year warranty.

US Patent Nos. 8,322,936; 8,846,171.



BMP21-PLUS Printer Kit shown.

Printer specifications	
Print speed	0.40 in. / sec.
Print and color capabilities	Thermal Transfer / Monochrome
Print resolution	203 dpi
PC compatibility or standalone	Standalone
Connectivity options	None
Software compatibility	None
Power supply options	Li-Ion rechargeable battery, 6AA, AC adapter
Standard warranty	2 years
Dimensions	4.5 in. W x 9.5 in. H x 2.5 in. D
Weight	1.04 lbs. (w/o tape, batteries)
Print features	
Screen size	3 lines x 14 characters
Backlit screen	Yes
Keyboard style	ABC
Max print width	0.75 in.
Font types available	(1) Brady Alpine
Font sizes (pts)	Auto, 6, 9, 14, 20, 28, 40
Multi-line label capabilities	4
Label print rotation	Yes
Data serialization	Alphanumeric
Barcode capabilities and types	Code 39, Code 128, QR and Data Matrix
Memory capacity	10 files up to 2 MB
Data transfer from PC	No
Print preview	No
Symbols available	193
Label supplies	
Label / ribbon supply	Cartridge w/ included ribbon
Material formats supported	Continuous labels only
Media width	0.25 in. to 0.75 in.
Types of materials	Outdoor vinyl, nylon cloth wire ID, heat-shrink wire ID, self-laminating wire ID, standard polyester, chemical resistant polyester
Quantity of label parts available	70+ label parts
Cartridge series	M21-series

An affordable label and wire marker printer designed for the toolbox



Residential panel labeling



Voice and data communications



Self-laminating wire labels



PermaSleeve® wire markers



General ID labeling



Lean / 5S labels and operations ID

Indoor and Outdoor Vinyl for Safety, Facility and Lean 5S (B-595)

Continuous vinyl material is ideal for lean 5S labels, pipe markers, equipment and production area identification. These labels offer excellent resistance to oils, detergents, dirt, grime and many solvents. Permanent adhesive, very pliable, good for rough surfaces and outdoor use. 8-10 years average outdoor durability.* Temp. range: -40° F to 180° F (-40° C to 82° C). UL recognized.

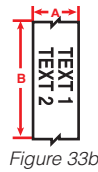

Figure	Catalog Number	B#	Material	Color	Label Width A Inch (mm)	Roll Length B Feet (m)	Labels Per Roll	Ribbon in Cartridge
Fig. 33b	** M21-250-595-WT	B-595	Vinyl	Black on White	0.250 (6.35)	21 (6.40)	1 roll (cont.)	R6000
Fig. 33b	M21-375-595-WT	B-595	Vinyl	Black on White	0.375 (9.53)	21 (6.40)	1 roll (cont.)	R6000
Fig. 33b	M21-500-595-WT	B-595	Vinyl	Black on White	0.500 (12.70)	21 (6.40)	1 roll (cont.)	R6000
Fig. 33b	M21-750-595-WT	B-595	Vinyl	Black on White	0.750 (19.05)	21 (6.40)	1 roll (cont.)	R6000
Fig. 33b	** M21-250-595-YL	B-595	Vinyl	Black on Yellow	0.250 (6.35)	21 (6.40)	1 roll (cont.)	R6000
Fig. 33b	M21-375-595-YL	B-595	Vinyl	Black on Yellow	0.375 (9.53)	21 (6.40)	1 roll (cont.)	R6000
Fig. 33b	M21-500-595-YL	B-595	Vinyl	Black on Yellow	0.500 (12.70)	21 (6.40)	1 roll (cont.)	R6000
Fig. 33b	M21-750-595-YL	B-595	Vinyl	Black on Yellow	0.750 (19.05)	21 (6.40)	1 roll (cont.)	R6000
Fig. 33b	M21-375-595-OR	B-595	Vinyl	Black on Orange	0.375 (9.53)	21 (6.40)	1 roll (cont.)	R6000
Fig. 33b	M21-500-595-OR	B-595	Vinyl	Black on Orange	0.500 (12.70)	21 (6.40)	1 roll (cont.)	R6000
Fig. 33b	M21-750-595-OR	B-595	Vinyl	Black on Orange	0.750 (19.05)	21 (6.40)	1 roll (cont.)	R6000
Fig. 33b	M21-375-595-BK	B-595	Vinyl	White on Black	0.375 (9.53)	21 (6.40)	1 roll (cont.)	R4400
Fig. 33b	M21-500-595-BK	B-595	Vinyl	White on Black	0.500 (12.70)	21 (6.40)	1 roll (cont.)	R4400
Fig. 33b	M21-750-595-BK	B-595	Vinyl	White on Black	0.750 (19.05)	21 (6.40)	1 roll (cont.)	R4400
Fig. 33b	M21-375-595-RD	B-595	Vinyl	White on Red	0.375 (9.53)	21 (6.40)	1 roll (cont.)	R4400
Fig. 33b	M21-500-595-RD	B-595	Vinyl	White on Red	0.500 (12.70)	21 (6.40)	1 roll (cont.)	R4400
Fig. 33b	M21-750-595-RD	B-595	Vinyl	White on Red	0.750 (19.05)	21 (6.40)	1 roll (cont.)	R4400
Fig. 33b	M21-375-595-BL	B-595	Vinyl	White on Blue	0.375 (9.53)	21 (6.40)	1 roll (cont.)	R4400
Fig. 33b	M21-500-595-BL	B-595	Vinyl	White on Blue	0.500 (12.70)	21 (6.40)	1 roll (cont.)	R4400
Fig. 33b	M21-750-595-BL	B-595	Vinyl	White on Blue	0.750 (19.05)	21 (6.40)	1 roll (cont.)	R4400
Fig. 33b	M21-375-595-BR	B-595	Vinyl	White on Brown	0.375 (9.53)	21 (6.40)	1 roll (cont.)	R4400
Fig. 33b	M21-500-595-BR	B-595	Vinyl	White on Brown	0.500 (12.70)	21 (6.40)	1 roll (cont.)	R4400
Fig. 33b	M21-750-595-BR	B-595	Vinyl	White on Brown	0.750 (19.05)	21 (6.40)	1 roll (cont.)	R4400
Fig. 33b	M21-375-595-GN	B-595	Vinyl	White on Green	0.375 (9.53)	21 (6.40)	1 roll (cont.)	R4400
Fig. 33b	M21-500-595-GN	B-595	Vinyl	White on Green	0.500 (12.70)	21 (6.40)	1 roll (cont.)	R4400
Fig. 33b	M21-750-595-GN	B-595	Vinyl	White on Green	0.750 (19.05)	21 (6.40)	1 roll (cont.)	R4400
Fig. 33b	M21-375-595-PL	B-595	Vinyl	White on Purple	0.375 (9.53)	21 (6.40)	1 roll (cont.)	R4400
Fig. 33b	M21-500-595-PL	B-595	Vinyl	White on Purple	0.500 (12.70)	21 (6.40)	1 roll (cont.)	R4400
Fig. 33b	M21-750-595-PL	B-595	Vinyl	White on Purple	0.750 (19.05)	21 (6.40)	1 roll (cont.)	R4400
Fig. 33b	M21-375-595-GY	B-595	Vinyl	Black on Gray	0.375 (9.53)	21 (6.40)	1 roll (cont.)	R6000
Fig. 33b	M21-500-595-GY	B-595	Vinyl	Black on Gray	0.500 (12.70)	21 (6.40)	1 roll (cont.)	R6000
Fig. 33b	M21-750-595-GY	B-595	Vinyl	Black on Gray	0.750 (19.05)	21 (6.40)	1 roll (cont.)	R6000

*Average expected outdoor life of product will depend on user definition of failure, climatic conditions, mounting techniques and material color. The 8 to 10 year outdoor durability applies to the vinyl label stock only; ribbon durability will vary.

** Cartridge is only compatible with the BMP®21-PLUS printer.

Patch Panel Adhesive Strips (B-499 and B-595)

Port identification with user-specified spacing when using patch panel mode

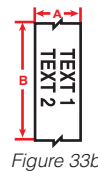

Figure	Catalog #	B#	Material	Color	Label Width A Inch (mm)	Roll Length B Feet (m)	Labels Per Roll	Ribbon in Cartridge
B-499 Nylon Cloth								
Fig. 33b	M21-375-499	B-499	Nylon Cloth	Black on White	0.375 (9.53)	16 (4.88)	1 roll (cont.)	R4300
Fig. 33b	M21-500-499	B-499	Nylon Cloth	Black on White	0.500 (12.70)	16 (4.88)	1 roll (cont.)	R4300
B-595 Vinyl								
Fig. 33b	M21-375-595-WT	B-595	Vinyl	Black on White	0.375 (9.53)	21 (6.40)	1 roll (cont.)	R6000
Fig. 33b	M21-500-595-WT	B-595	Vinyl	Black on White	0.500 (12.70)	21 (6.40)	1 roll (cont.)	R6000

BradyID.com/s36

Terminal Block Adhesive Strips (B-499)

- Narrow nylon cloth label strips for alignment on terminal blocks
- Prints with user-specified spacing when using terminal block mode



Figure 33b



Figure	Catalog #	B#	Material	Color	Label Width A Inch (mm)	Roll Length B Feet (m)	Labels Per Roll	Ribbon in Cartridge
Fig. 33b	M21-375-499-TB	B-499	Nylon Cloth	Black on White	0.375 (9.53)	16 (4.88)	1 roll (cont.)	R4300
Fig. 33b	M21-500-499-TB	B-499	Nylon Cloth	Black on White	0.500 (12.70)	16 (4.88)	1 roll (cont.)	R4300

Nylon Cloth Wire and Cable Labels (B-499)

- Nylon cloth wrap-around label is highly pliable, conforming to tightly curved surfaces
- Text auto-repeats when in wire marker mode
- Can be used for flagging with flag mode in printer



Figure 33b



Figure	Catalog #	B#	Material	Color	Label Width A Inch (mm)	Roll Length B Feet (m)	Labels Per Roll	Ribbon in Cartridge
Fig. 33b	M21-375-499	B-499	Nylon Cloth	Black on White	0.375 (9.53)	16 (4.88)	1 roll (cont.)	R4300
Fig. 33b	M21-500-499	B-499	Nylon Cloth	Black on White	0.500 (12.70)	16 (4.88)	1 roll (cont.)	R4300
Fig. 33b	M21-750-499	B-499	Nylon Cloth	Black on White	0.750 (19.05)	16 (4.88)	1 roll (cont.)	R4300

Self-Laminating Vinyl Wire and Cable Labels (B-427)

- Clear, wrap-around tail overlaminates white print-on area to protect text
- Great for data cables or wires that are frequently handled and moved
- US Patent No. 8,846,171

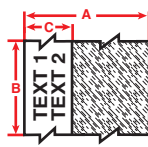

Figure 42b



Figure	Catalog #	B#	Material	Color	Approx. Wire Gauge	Label Width A Inch (mm)	Roll Length B Feet (m)	Print-On Height C Inch (mm)	Labels Per Roll	Ribbon in Cartridge
Fig. 42b	* M21-750-427	B-427	Vinyl	Black on White	16 to 10	0.75 (19.05)	14 (4.27)	0.375 (9.53)	1 roll (cont.)	R4300
Fig. 42b	* M21-1000-427	B-427	Vinyl	Black on White	12 to 10	1.00 (25.40)	14 (4.27)	0.375 (9.53)	1 roll (cont.)	R4300
Fig. 42b	* M21-1250-427	B-427	Vinyl	Black on White	10 to 4	1.25 (30.48)	14 (4.27)	0.50 (12.70)	1 roll (cont.)	R4300
Fig. 42b	* M21-1500-427	B-427	Vinyl	Black on White	10 to 4	1.50 (38.10)	14 (4.27)	0.50 (12.70)	1 roll (cont.)	R4300

* Cartridge is only compatible with the BMP®21-PLUS and BMP®21 printers.

PermaSleeve® PS Heat-shrink Wire Markers (B-342)

- 3:1 shrink ratio, wire marker sleeve
- Polyolefin fade-resistant, flame-retardant and superior aesthetic appearance
- Meets SAE, MIL-STD specs



Figure 33b



Figure	Catalog #	B#	Material	Color	Approx. Wire Gauge	Max Wire Dia. Inch (mm)	Supplied Dia. A Inch (mm)	Roll Length B Feet (m)	Labels Per Roll	Ribbon in Cartridge
Fig. 33b	*** M21-125-C-342	B-342	Polyolefin	Black on White	22 to 16	0.046 - 0.110 (1.2 - 2.8)	0.125 (3.2)	7 (2.13)	1 roll (cont.)	R4300
Fig. 33b	** M21-187-C-342	B-342	Polyolefin	Black on White	20 to 10	0.062 - 0.150 (1.6 - 3.8)	0.187 (4.9)	7 (2.13)	1 roll (cont.)	R4300
Fig. 33b	** M21-250-C-342	B-342	Polyolefin	Black on White	16 to 8	0.094 - 0.215 (2.4 - 5.5)	0.250 (6.9)	7 (2.13)	1 roll (cont.)	R4300
Fig. 33b	** M21-375-C-342	B-342	Polyolefin	Black on White	12 to 4	0.125 - 0.320 (3.2 - 8.1)	0.375 (10.7)	7 (2.13)	1 roll (cont.)	R4300
Fig. 33b	*** M21-125-C-342-YL	B-342	Polyolefin	Black on Yellow	22 to 16	0.046 - 0.110 (1.2 - 2.8)	0.125 (3.2)	7 (2.13)	1 roll (cont.)	R4300
Fig. 33b	** M21-187-C-342-YL	B-342	Polyolefin	Black on Yellow	20 to 10	0.062 - 0.150 (1.6 - 3.8)	0.187 (4.9)	7 (2.13)	1 roll (cont.)	R4300
Fig. 33b	** M21-250-C-342-YL	B-342	Polyolefin	Black on Yellow	16 to 8	0.094 - 0.215 (2.4 - 5.5)	0.250 (6.9)	7 (2.13)	1 roll (cont.)	R4300
Fig. 33b	** M21-375-C-342-YL	B-342	Polyolefin	Black on Yellow	12 to 4	0.125 - 0.320 (3.2 - 8.1)	0.375 (10.7)	7 (2.13)	1 roll (cont.)	R4300

* Cartridge is only compatible with the BMP®21-PLUS printer.

** ⚠️ **WARNING:** Cancer www.P65Warnings.ca.gov

Polyester Labels for Inside Panel Markings and General ID (B-423, B-430 and B-488)

High performance white or clear polyester material that is best for use on smooth, flat surfaces

- B-488 polyester is a solvent-resistant material
- B-499 nylon cloth or B-595 vinyl label materials are recommended if surface is highly textured



Figure 33b



Figure	Catalog #	B#	Material	Color	Label Width A Inch (mm)	Roll Length B Feet (m)	Labels Per Roll	Ribbon in Cartridge
B-423 Polyester (gloss white)								
Fig. 33b	* M21-250-423	B-423	Polyester	Black on White	0.250 (6.35)	21 (6.40)	1 roll (cont.)	R6200
Fig. 33b	M21-375-423	B-423	Polyester	Black on White	0.375 (9.53)	21 (6.40)	1 roll (cont.)	R6200
Fig. 33b	M21-500-423	B-423	Polyester	Black on White	0.500 (12.70)	21 (6.40)	1 roll (cont.)	R6200
Fig. 33b	M21-750-423	B-423	Polyester	Black on White	0.750 (19.05)	21 (6.40)	1 roll (cont.)	R6200
B-430 Polyester (clear)								
Fig. 33b	* M21-250-430	B-430	Polyester	Black on Clear	0.250 (6.35)	21 (6.40)	1 roll (cont.)	R6200
Fig. 33b	M21-375-430	B-430	Polyester	Black on Clear	0.375 (9.53)	21 (6.40)	1 roll (cont.)	R6200
Fig. 33b	M21-500-430	B-430	Polyester	Black on Clear	0.500 (12.70)	21 (6.40)	1 roll (cont.)	R6200
Fig. 33b	M21-750-430	B-430	Polyester	Black on Clear	0.750 (19.05)	21 (6.40)	1 roll (cont.)	R6200
Fig. 33b	* M21-250-430-WT-CL	B-430	Polyester	White on Clear	0.250 (6.35)	21 (6.40)	1 roll (cont.)	R6200
Fig. 33b	M21-375-430-WT-CL	B-430	Polyester	White on Clear	0.375 (9.53)	21 (6.40)	1 roll (cont.)	R6200
Fig. 33b	M21-500-430-WT-CL	B-430	Polyester	White on Clear	0.500 (12.70)	21 (6.40)	1 roll (cont.)	R6200
Fig. 33b	M21-750-430-WT-CL	B-430	Polyester	White on Clear	0.750 (19.05)	21 (6.40)	1 roll (cont.)	R6200
B-488 Polyester (matte white)								
Fig. 33b	M21-375-488	B-488	Polyester	Black on White	0.375 (9.53)	21 (6.40)	1 roll (cont.)	R4300
Fig. 33b	M21-500-488	B-488	Polyester	Black on White	0.500 (12.70)	21 (6.40)	1 roll (cont.)	R4300
Fig. 33b	M21-750-488	B-488	Polyester	Black on White	0.750 (19.05)	21 (6.40)	1 roll (cont.)	R4300

* Cartridge is only compatible with the BMP®21-PLUS printer.

Laboratory Labels (B-461 and B-7425)

- B-461 features clear, wrap-around tail that overlaminates white print-on area to protect text
- B-7425 economical white polypropylene is chemical and high-temperature resistant



Figure 33b

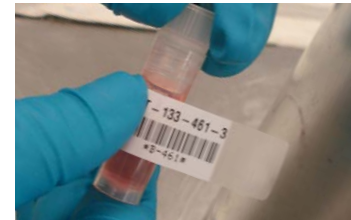

Figure	Catalog #	B#	Material	Color	Label Width A Inch (mm)	Roll Length B Feet (m)	Labels Per Roll	Ribbon in Cartridge
B-461 Self-Laminating Polyester								
Fig. 33b	M21-375-461	B-461	Polyester	Black on White	0.375 (9.53)	21 (6.40)	1 roll (cont.)	R4300
Fig. 33b	M21-500-461	B-461	Polyester	Black on White	0.500 (12.70)	21 (6.40)	1 roll (cont.)	R4300
Fig. 33b	M21-750-461	B-461	Polyester	Black on White	0.750 (19.05)	21 (6.40)	1 roll (cont.)	R4300
B-7425 Polypropylene								
Fig. 33b	M21-375-7425	B-7425	Polypropylene	Black on White	0.375 (9.53)	21 (6.40)	1 roll (cont.)	R4300
Fig. 33b	M21-500-7425	B-7425	Polypropylene	Black on White	0.500 (12.70)	21 (6.40)	1 roll (cont.)	R4300
Fig. 33b	M21-750-7425	B-7425	Polypropylene	Black on White	0.750 (19.05)	21 (6.40)	1 roll (cont.)	R4300

Water Dissolvable Paper Labels (B-403)

Paper material completely dissolves in warm water within 30 seconds, leaving no adhesive residue



Figure 33b

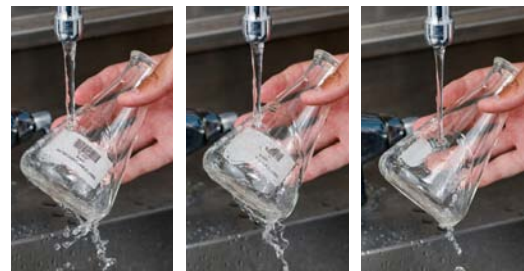

Figure	Catalog #	B#	Material	Color	Label Width A Inch (mm)	Roll Length B Feet (m)	Labels Per Roll	Ribbon in Cartridge
Fig. 33b	M21-750-403	B-403	Dissolvable Paper	Black on White	0.750 (19.05)	21 (6.40)	1 roll (cont.)	R4300

BMP®41 Label Printer

BradyID.com/s36



BMP®41 LABEL PRINTER

One and done BMP41 label printer does it all

A rugged, handheld labeling solution that gives you the versatility of die-cut labels and continuous labels in one printer!

- Quick-load, drop-in cartridges for quick supply change and automatic label formatting
- Fast print speed of 1.3 in. per second
- Over 100 label parts with 11 materials
- 0.75 in. sleeves and 1 in. wide continuous output
- Drop-tested, rugged industrial bumpers with a grab-and-go grip to be on the move with you
- Large graphical LCD display with backlight to see exactly what you're printing
- Rechargeable NiMH battery or AC adapter for long-lasting power supply
- Built-in wizard-style apps for wire ID, cable flags, terminal blocks, patch panels, breaker boxes and general ID

Printer specifications	
Print speed	1.30 in. / sec.
Print and color capabilities	Thermal Transfer / Monochrome
Print resolution	300 dpi
PC compatibility or standalone	Standalone and PC connect
Connectivity options	USB
Software compatibility	Brady Workstation Apps, LabelMark™ Software,
Power supply options	NiMH rechargeable battery, AC adapter
Warranty	2 years
Dimensions	6.0 in. W x 11.5 in. H x 3.6 in. D
Weight	2.1 lbs. (w/o tape, batteries)
Print features	
Screen size	13 lines x 36 characters
Backlit screen	Yes
Keyboard style	QWERTY
Max print width	1.0 in.
Font types available	(2) Brady Alpine and Brady Fixed Width
Font sizes (pts)	Custom, auto, 4, 6, 7, 9, 10, 13, 14, 16, 20, 26, 28, 32, 38, 40, 42, 45, 51, 55, 60, 65
Multi-line label capabilities	25
Label print rotation	Yes
Data serialization	Yes, multiple and linked
Barcode capabilities and types	Code 39, Code 128 and more using Brady Workstation
Memory capacity	25,000 characters up to 48 MB
Data transfer from PC	Yes
Print preview	Yes
Symbols available	450
Label supplies	
Label / ribbon supply	Cartridge w/ included ribbon
Material formats	Continuous and die-cut labels
Media width	0.25 in. to 1.0 in.
Types of materials	Outdoor vinyl, nylon cloth wire ID, heat-shrink wire ID, self-laminating wire ID, removable cloth wire ID, standard polyester, aggressive adhesive polyester, metallized polyester, non-adhesive tag, outdoor reflective
Quantity of label parts available	100+ label parts
Cartridge series	M-series up to 1 in. wide

Portable Printers

BMP41

▶ Watch the demo video at BradyID.com/bmp41

Your complete printing solution:

BMP41 cartridges with label and print ribbon page 109

BMP41 label printer and accessories

Catalog #	Description
BMP41	BMP41 Label Printer with Hard Case*
BMP41-KIT-VD	BMP41 Printer DataComm Starter Kit*
BMP41-KIT-EL	BMP41 Printer Electrical Starter Kit*
BMP41-KIT-GI	BMP41 Printer Facility ID Starter Kit*
BMP41-BATT	BMP41 Rechargeable Battery Pack
BMP41-QC	BMP41 External Battery Quick Charger
M-AC-143110	BMP41 AC Adapter / Battery Charger
BMP41-MAGNET	BMP41 Magnet Accessory
M-USB-103788	BMP41 USB Cable
BMP41-HC	BMP41 Hard Case
BMP-SC-2	BMP41 Soft Case

*Printer includes BMP41 printer, NiMH battery, AC adapter / charger, hard case, MC1-1000-595-WT-BK cartridge, USB cable, product and drivers CD, quick start guide and 2-year warranty.

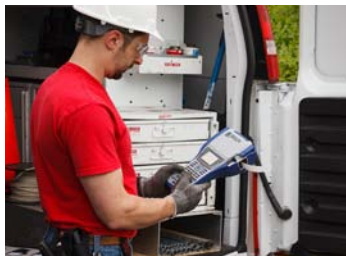

Exceptional material variety and durability

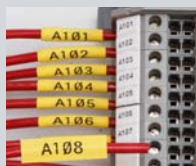

Electrical labeling

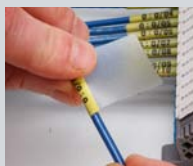

Self-laminating wire labels



Voice and data communications



PermaSleeve® wire markers



Equipment labeling

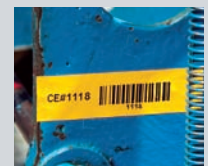

Indoor and outdoor vinyl labels

Save with Printer Starter Kits



Catalog #	Kit Contents
BMP41 DataComm Starter Kit (BMP41-KIT-VD)	1 - BMP41 Label Printer Standard Package (BMP41-KIT) 1 - BMP41 Hard Case (BMP41-HC) 1 - 1.0 in. black on white B-427 cartridge (M-51-427) 1 - 0.475 in. black on white B-412 cartridge (MC-475-412) 1 - 1.0 in. black on yellow B-595 cartridge (MC1-1000-595-YL-BK) 1 - 1.0 in. black on white B-595 cartridge (MC1-1000-595-WT-BK)
BMP41 Electrical Starter Kit (BMP41-KIT-EL)	1 - BMP41 Label Printer Standard Package (BMP41-KIT) 1 - BMP41 Hard Case (BMP41-HC) 1 - 1.0 in. black on white B-427 cartridge (M-143-427) 1 - 1.0 in. black on white B-498 cartridge (M-48-498) 1 - 0.75 in. black on white B-342 cartridge (M-187-075-342) 1 - 1.0 in. black on orange B-595 cartridge (MC1-1000-595-OR-BK) 1 - 1.0 in. black on white B-595 cartridge (MC1-1000-595-WT-BK)
BMP41 Facility ID Starter Kit (BMP41-KIT-GI)	1 - BMP41 Label Printer Standard Package (BMP41-KIT) 1 - 1.0 in. black on yellow B-595 cartridge (MC1-1000-595-YL-BK) 1 - 1.0 in. red on white B-595 cartridge (MC1-1000-595-WT-RD) 1 - 1.0 in. white on green B-595 cartridge (MC1-1000-595-GN-WT) 1 - 1.0 in. black on white B-595 cartridge (MC1-1000-595-WT-BK) 1 - 1.0 in. black on white B-483 cartridge (M-60-483)

*Printer ships with BMP41 rechargeable battery pack, MC1-1000-595-WT-BK cartridge, USB cable, AC adapter, product CD, printer drivers CD, quick start guide and 2-year warranty.

Indoor and Outdoor Vinyl for Safety, Facility and Lean 5S (B-595)

Continuous vinyl material is ideal for lean 5S labels, pipe markers, equipment and production area identification. These labels offer excellent resistance to oils, detergents, dirt, grime and many solvents. Permanent adhesive, very pliable, good for rough surfaces and outdoor use. 8-10 years average outdoor durability.* Temp. range: -40° F to 180° F (-40° C to 82° C). UL recognized.



Figure 33



Fits Printers	Figure	Catalog #	B#	Material	Color	Label Width A Inch (mm)	Roll Length B Feet (m)	Labels Per Roll	Ribbon in Cartridge
BMP41, 51, 53	Fig. 33	MC-375-595-WT-BK	B-595	Vinyl	BK on WT	0.375 (9.5)	25 (7.6)	1 roll (cont.)	R6000
BMP41, 51, 53	Fig. 33	MC-500-595-WT-BK	B-595	Vinyl	BK on WT	0.500 (12.7)	25 (7.6)	1 roll (cont.)	R6000
BMP41, 51, 53	Fig. 33	MC-750-595-WT-BK	B-595	Vinyl	BK on WT	0.750 (19.1)	25 (7.6)	1 roll (cont.)	R6000
BMP41, 51, 53	Fig. 33	MC1-1000-595-WT-BK	B-595	Vinyl	BK on WT	1.000 (25.4)	25 (7.6)	1 roll (cont.)	R6000
BMP41, 51, 53	Fig. 33	MC-375-595-YL-BK	B-595	Vinyl	BK on YL	0.375 (9.5)	25 (7.6)	1 roll (cont.)	R6000
BMP41, 51, 53	Fig. 33	MC-500-595-YL-BK	B-595	Vinyl	BK on YL	0.500 (12.7)	25 (7.6)	1 roll (cont.)	R6000
BMP41, 51, 53	Fig. 33	MC-750-595-YL-BK	B-595	Vinyl	BK on YL	0.750 (19.1)	25 (7.6)	1 roll (cont.)	R6000
BMP41, 51, 53	Fig. 33	MC1-1000-595-YL-BK	B-595	Vinyl	BK on YL	1.000 (25.4)	25 (7.6)	1 roll (cont.)	R6000
BMP41, 51, 53	Fig. 33	MC-500-595-OR-BK	B-595	Vinyl	BK on OR	0.500 (12.7)	25 (7.6)	1 roll (cont.)	R6000
BMP41, 51, 53	Fig. 33	MC-750-595-OR-BK	B-595	Vinyl	BK on OR	0.750 (19.1)	25 (7.6)	1 roll (cont.)	R6000
BMP41, 51, 53	Fig. 33	MC1-1000-595-OR-BK	B-595	Vinyl	BK on OR	1.000 (25.4)	25 (7.6)	1 roll (cont.)	R6000
BMP41, 51, 53	Fig. 33	MC-500-595-BL-WT	B-595	Vinyl	WT on BL	0.500 (12.7)	25 (7.6)	1 roll (cont.)	R4400
BMP41, 51, 53	Fig. 33	MC-750-595-BL-WT	B-595	Vinyl	WT on BL	0.750 (19.1)	25 (7.6)	1 roll (cont.)	R4400
BMP41, 51, 53	Fig. 33	MC1-1000-595-BL-WT	B-595	Vinyl	WT on BL	1.000 (25.4)	25 (7.6)	1 roll (cont.)	R4400
BMP41, 51, 53	Fig. 33	MC-375-595-RD-WT	B-595	Vinyl	WT on RD	0.375 (9.5)	25 (7.6)	1 roll (cont.)	R4400
BMP41, 51, 53	Fig. 33	MC-500-595-RD-WT	B-595	Vinyl	WT on RD	0.500 (12.7)	25 (7.6)	1 roll (cont.)	R4400
BMP41, 51, 53	Fig. 33	MC-750-595-RD-WT	B-595	Vinyl	WT on RD	0.750 (19.1)	25 (7.6)	1 roll (cont.)	R4400
BMP41, 51, 53	Fig. 33	MC1-1000-595-RD-WT	B-595	Vinyl	WT on RD	1.000 (25.4)	25 (7.6)	1 roll (cont.)	R4400
BMP41, 51, 53	Fig. 33	MC-500-595-GN-WT	B-595	Vinyl	WT on GN	0.500 (12.7)	25 (7.6)	1 roll (cont.)	R4400
BMP41, 51, 53	Fig. 33	MC-750-595-GN-WT	B-595	Vinyl	WT on GN	0.750 (19.1)	25 (7.6)	1 roll (cont.)	R4400
BMP41, 51, 53	Fig. 33	MC1-1000-595-GN-WT	B-595	Vinyl	WT on GN	1.000 (25.4)	25 (7.6)	1 roll (cont.)	R4400
BMP41, 51, 53	Fig. 33	MC-500-595-WT-RD	B-595	Vinyl	RD on WT	0.500 (12.7)	25 (7.6)	1 roll (cont.)	R4400
BMP41, 51, 53	Fig. 33	MC-750-595-WT-RD	B-595	Vinyl	RD on WT	0.750 (19.1)	25 (7.6)	1 roll (cont.)	R4400
BMP41, 51, 53	Fig. 33	MC1-1000-595-WT-RD	B-595	Vinyl	RD on WT	1.000 (25.4)	25 (7.6)	1 roll (cont.)	R4400
BMP41, 51, 53	Fig. 33	MC-500-595-BK-WT	B-595	Vinyl	WT on BK	0.500 (12.7)	25 (7.6)	1 roll (cont.)	R4400
BMP41, 51, 53	Fig. 33	MC-750-595-BK-WT	B-595	Vinyl	WT on BK	0.750 (19.1)	25 (7.6)	1 roll (cont.)	R4400
BMP41, 51, 53	Fig. 33	MC1-1000-595-BK-WT	B-595	Vinyl	WT on BK	1.000 (25.4)	25 (7.6)	1 roll (cont.)	R4400
BMP41, 51, 53	Fig. 33	MC-500-595-CL-BK	B-595	Vinyl	BK on CL	0.500 (12.7)	20 (6.09)	1 roll (cont.)	R6000
BMP41, 51, 53	Fig. 33	MC-750-595-CL-BK	B-595	Vinyl	BK on CL	0.750 (19.1)	20 (6.09)	1 roll (cont.)	R6000
BMP41, 51, 53	Fig. 33	MC1-1000-595-CL-BK	B-595	Vinyl	BK on CL	1.000 (25.4)	20 (6.09)	1 roll (cont.)	R6000
BMP41, 51, 53	Fig. 33	MC-500-595-CL-WT	B-595	Vinyl	WT on CL	0.500 (12.7)	20 (6.09)	1 roll (cont.)	R4400
BMP41, 51, 53	Fig. 33	MC-750-595-CL-WT	B-595	Vinyl	WT on CL	0.750 (19.1)	20 (6.09)	1 roll (cont.)	R4400
BMP41, 51, 53	Fig. 33	MC1-1000-595-CL-WT	B-595	Vinyl	WT on CL	1.000 (25.4)	20 (6.09)	1 roll (cont.)	R4400

* Average expected outdoor life of product will depend on user definition of failure, climatic conditions, mounting techniques and material color. The 8 to 10 year outdoor durability applies to the vinyl label stock only; ribbon durability will vary.

Bin, Storage, Reflective and General Industrial Labels (B-422, B-483, B-499, B-584 and B-595)

Several materials with an aggressive adhesive for use in commercial and industrial applications. Reflective materials can be used for low light or inclement weather conditions on outdoor utility poles and pedestals, jobsite equipment and rooftop equipment.

- **B-422 Polyester Material:** Permanent adhesive, good for powder-coated. Best on flat surfaces. Temp. range: -40° F to 212° F (-40° C to 100° C). UL recognized.
- **B-483 Polyester Material:** Permanent adhesive, good for powder-coated. Best on flat surfaces. Temp. range: -40° F to 248° F (-40° C to 120° C). UL recognized.
- **B-499 Nylon Cloth Material:** Permanent adhesive. Pliable for rough or smooth surfaces. Temp. range: -94° F to 194° F (-70° C to 90° C). UL recognized.
- **B-584 Reflective Tape:** Reflective material shines back brightly when struck by light. Meets Federal Spec L-S-300 for reflectivity. Average outdoor durability is 4-6 years. Temp. range: -40° F to 158° F (-40° C to 70° C).
- **B-595 Indoor and Outdoor Vinyl Material:** Permanent adhesive, very pliable, good for rough surfaces and outdoor use, wide range of colors. Temp. range: -40° F to 180° F (-40° C to 82° C). UL recognized.

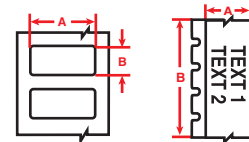

Figure 2

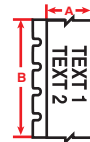

Figure 3

Fits Printers	Figure	Catalog #	B#	Material	Color	Label Width A Inch (mm)	Label Height B Inch (mm)	Labels Per Roll	Ribbon in Cartridge
B-422 Polyester Material									
BMP41, 51, 53	Fig. 33	MC-375-422	B-422	Polyester	BK on WT	0.375 (9.5)	25 ft. (7.6 m)	1 roll (cont.)	R6000
BMP41, 51, 53	Fig. 33	MC-475-422	B-422	Polyester	BK on WT	0.475 (12.1)	25 ft. (7.6 m)	1 roll (cont.)	R6000
BMP41, 51, 53	Fig. 2	M-7-422	B-422	Polyester	BK on WT	0.500 (12.7)	0.500 (12.7)	280	R6000
BMP41, 51, 53	Fig. 33	MC-500-422	B-422	Polyester	BK on WT	0.500 (12.7)	25 ft. (7.6 m)	1 roll (cont.)	R6000
BMP41, 51, 53	Fig. 33	MC-625-422	B-422	Polyester	BK on WT	0.625 (15.9)	25 ft. (7.6 m)	1 roll (cont.)	R6000
BMP41, 51, 53	Fig. 2	M-47-422	B-422	Polyester	BK on WT	1.000 (25.4)	0.500 (12.7)	480	R6000
BMP41, 51, 53	Fig. 2	M-49-422	B-422	Polyester	BK on WT	1.000 (25.4)	1.000 (25.4)	260	R6000
BMP41, 51, 53	Fig. 33	MC1-1000-422	B-422	Polyester	BK on WT	1.000 (25.4)	25 ft. (7.6 m)	1 roll (cont.)	R6000
BMP41, 51, 53	Fig. 2	M-89-422	B-422	Polyester	BK on WT	1.500 (38.1)	0.500 (12.7)	180	R6000
BMP41, 51, 53	Fig. 2	M-90-422	B-422	Polyester	BK on WT	1.500 (38.1)	0.750 (19.1)	180	R6000
B-483 Ultra-Aggressive Polyester									
BMP41, 51, 53	Fig. 2	M-47-483	B-483	Polyester	BK on WT	1.000 (25.4)	0.500 (12.7)	480	R6000
BMP41, 51, 53	Fig. 2	M-60-483	B-483	Polyester	BK on WT	2.000 (50.8)	1.000 (25.4)	140	R6000
B-499 Nylon Cloth Labels									
BMP41, 51, 53	Fig. 33	MC-375-499	B-499	Nylon Cloth	BK on WT	0.375 (9.5)	16 ft. (4.9 m)	1 roll (cont.)	R4300
BMP41, 51, 53	Fig. 33	MC-500-499	B-499	Nylon Cloth	BK on WT	0.500 (12.7)	16 ft. (4.9 m)	1 roll (cont.)	R4300
BMP41, 51, 53	Fig. 2	M-11-499	B-499	Nylon Cloth	BK on WT	0.750 (19.1)	0.500 (12.7)	220	R4300
BMP41, 51, 53	Fig. 33	MC-750-499	B-499	Nylon Cloth	BK on WT	0.750 (19.1)	16 ft. (4.9 m)	1 roll (cont.)	R4300
BMP41, 51, 53	Fig. 2	M-130-499	B-499	Nylon Cloth	BK on WT	0.825 (20.9)	0.375 (9.5)	220	R4300
BMP41, 51, 53	Fig. 2	M-84-499	B-499	Nylon Cloth	BK on WT	0.900 (22.8)	0.500 (12.7)	200	R4300
BMP41, 51, 53	Fig. 2	M-131-499	B-499	Nylon Cloth	BK on WT	1.000 (25.4)	0.500 (12.7)	180	R4300
BMP41, 51, 53	Fig. 2	M-128-499	B-499	Nylon Cloth	BK on WT	1.000 (25.4)	1.900 (48.3)	100	R4300
B-584 Reflective Tape									
BMP41, 51, 53	Fig. 33	MC-500-584	B-584	Reflective	BK on WT	0.500 (12.7)	20 ft. (6.1 m)	1 roll (cont.)	R6000
BMP41, 51, 53	Fig. 33	MC-750-584	B-584	Reflective	BK on WT	0.750 (19.1)	20 ft. (6.1 m)	1 roll (cont.)	R6000
BMP41, 51, 53	Fig. 33	MC-500-584-YL	B-584	Reflective	BK on YL	0.500 (12.7)	20 ft. (6.1 m)	1 roll (cont.)	R6000
BMP41, 51, 53	Fig. 33	MC-750-584-YL	B-584	Reflective	BK on YL	0.750 (19.1)	20 ft. (6.1 m)	1 roll (cont.)	R6000
B-595 Indoor and Outdoor Vinyl Tape									
BMP41, 51, 53	Fig. 33	MC-500-595-RD-WT	B-595	Vinyl	WT on RD*	0.500 (12.7)	25 ft. (7.6 m)	1 roll (cont.)	R4400
BMP41, 51, 53	Fig. 33	MC-750-595-RD-WT	B-595	Vinyl	WT on RD*	0.750 (19.1)	25 ft. (7.6 m)	1 roll (cont.)	R4400
BMP41, 51, 53	Fig. 33	MC1-1000-595-RD-WT	B-595	Vinyl	WT on RD*	1.000 (25.4)	25 ft. (7.6 m)	1 roll (cont.)	R4400

* For additional general purpose tapes in other colors, refer to the indoor and outdoor grade facility and safety labels on page 109.

BMP41 cartridges

The necessary print ribbons for the BMP41 Label Printer are self-contained within the label roll cartridge.

No need to order or load separate print ribbons.



Inside-Panel Component Labels for Electrical and Automation Applications (B-422, B-428, B-483, B-499 and B-595)

Variety of durable materials ideal for marking backer boards, DIN rail, relays, PLCs, switches and solenoids. Create serial or rating plates with barcodes, graphics and more with a flexible high-tack adhesive for easy and long-lasting adhesion.

- **B-422 Polyester Material:** Permanent adhesive, good for powder-coated / textured surfaces. Best on flat surfaces. Temp. range: -40° F to 212° F (-40° C to 100° C). UL recognized.
- **B-428 Metallized Polyester Material:** Permanent adhesive, silver finish. Temp. range: -40° F to 176° F (-40° C to 80° C). UL recognized.
- **B-483 Polyester Material:** Permanent adhesive, good for powder-coated / textured surfaces. Best on flat surfaces Temp. range: -40° F to 248° F (-40° C to 120° C). UL recognized.
- **B-499 Nylon Cloth Material:** Permanent adhesive. Pliable for rough or smooth surfaces. Temp. range: -94° F to 194° F (-70° C to 90° C). UL recognized.
- **B-595 Indoor and Outdoor Vinyl Material:** Permanent adhesive, very pliable, good for rough surfaces and outdoor use, wide range of colors. Temp. range: -40° F to 180° F (-40° C to 82° C). UL recognized.

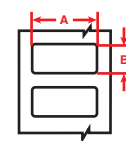

Figure 2

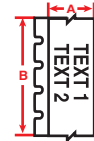

Figure 33

Fits Printers	Figure	Catalog #	B#	Material	Color	Label Width A Inch (mm)	Label Height B Inch (mm)	Labels Per Roll	Ribbon in Cartridge
B-422 Polyester Material									
BMP41, 51, 53	Fig. 33	MC-375-422	B-422	Polyester	BK on WT	0.375 (9.5)	25 ft. (7.6 m)	1 roll (cont.)	R6000
BMP41, 51, 53	Fig. 33	MC-475-422	B-422	Polyester	BK on WT	0.475 (12.1)	25 ft. (7.6 m)	1 roll (cont.)	R6000
BMP41, 51, 53	Fig. 2	M-7-422	B-422	Polyester	BK on WT	0.500 (12.7)	0.500 (12.7)	280	R6000
BMP41, 51, 53	Fig. 33	MC-500-422	B-422	Polyester	BK on WT	0.500 (12.7)	25 ft. (7.6 m)	1 roll (cont.)	R6000
BMP41, 51, 53	Fig. 33	MC-625-422	B-422	Polyester	BK on WT	0.625 (15.8)	25 ft. (7.6 m)	1 roll (cont.)	R6000
BMP41, 51, 53	Fig. 2	M-47-422	B-422	Polyester	BK on WT	1.000 (25.4)	0.500 (12.7)	480	R6000
BMP41, 51, 53	Fig. 2	M-49-422	B-422	Polyester	BK on WT	1.000 (25.4)	1.000 (25.4)	260	R6000
BMP41, 51, 53	Fig. 33	MC1-1000-422	B-422	Polyester	BK on WT	1.000 (25.4)	25 ft. (7.6 m)	1 roll (cont.)	R6000
BMP41, 51, 53	Fig. 2	M-89-422	B-422	Polyester	BK on WT	1.500 (38.1)	0.500 (12.7)	180	R6000
BMP41, 51, 53	Fig. 2	M-90-422	B-422	Polyester	BK on WT	1.500 (38.1)	0.750 (19.1)	180	R6000
B-428 Metallized Polyester Material									
BMP41, 51, 53	Fig. 2	M-47-428	B-428	Polyester	BK on Lt Gray	1.000 (25.4)	0.500 (12.7)	480	R4300
BMP41, 51, 53	Fig. 2	M-92-428-BB	B-428	Polyester	BK on Lt Gray	1.130 (28.7)	0.500 (12.7)	239	R4300
BMP41, 51, 53	Fig. 2	M-60-428	B-428	Polyester	BK on Lt Gray	2.000 (50.8)	1.000 (25.4)	140	R4300
B-483 Ultra-Aggressive Polyester									
BMP41, 51, 53	Fig. 2	M-60-483	B-483	Polyester	BK on WT	2.000 (50.8)	1.000 (25.4)	140	R6000
B-499 Nylon Cloth Material									
BMP41, 51, 53	Fig. 33	MC-375-499	B-499	Nylon Cloth	BK on WT	0.375 (9.5)	16 ft. (4.9 m)	1 roll (cont.)	R4300
BMP41, 51, 53	Fig. 33	MC-500-499	B-499	Nylon Cloth	BK on WT	0.500 (12.7)	16 ft. (4.9 m)	1 roll (cont.)	R4300
BMP41, 51, 53	Fig. 33	M-11-499	B-499	Nylon Cloth	BK on WT	0.750 (19.1)	0.500 (12.7)	1 roll (cont.)	R4300
BMP41, 51, 53	Fig. 33	MC-750-499	B-499	Nylon Cloth	BK on WT	0.750 (19.1)	16 ft. (4.9 m)	1 roll (cont.)	R4300
BMP41, 51, 53	Fig. 33	M-130-499	B-499	Nylon Cloth	BK on WT	0.825 (20.9)	0.375 (9.5)	1 roll (cont.)	R4300
BMP41, 51, 53	Fig. 33	M-84-499	B-499	Nylon Cloth	BK on WT	0.900 (22.8)	0.500 (12.7)	1 roll (cont.)	R4300
BMP41, 51, 53	Fig. 33	M-131-499	B-499	Nylon Cloth	BK on WT	1.000 (25.4)	0.500 (12.7)	1 roll (cont.)	R4300
BMP41, 51, 53	Fig. 33	M-128-499	B-499	Nylon Cloth	BK on WT	1.000 (25.4)	1.900 (48.3)	1 roll (cont.)	R4300
B-595 Indoor and Outdoor Vinyl Material									
BMP41, 51, 53	Fig. 33	MC-500-595-OR-BK	B-595	Vinyl	BK on OR*	0.500 (12.7)	25 ft. (7.6 m)	1 roll (cont.)	R6000
BMP41, 51, 53	Fig. 33	MC-750-595-OR-BK	B-595	Vinyl	BK on OR*	0.750 (19.1)	25 ft. (7.6 m)	1 roll (cont.)	R6000
BMP41, 51, 53	Fig. 33	MC1-1000-595-OR-BK	B-595	Vinyl	BK on OR*	1.000 (25.4)	25 ft. (7.6 m)	1 roll (cont.)	R6000

* For additional general purpose tapes, refer to the indoor and outdoor grade facility and safety labels on page 109.

BMP41 magnet accessory

The optional heavy-duty magnet accessory for BMP41 allows you to go hands free. Apply the magnet to the back of your printer and then stick it to a magnetized surface or wall.



Self-Laminating Vinyl Wire and Cable Labels (B-427)

Labels feature a clear, non-printable area that wraps around print-on area to protect text. Vinyl material offers superior resistance to handling, solvents, oil, grease, dirt and water. Temp. range -40° F to 158° F (-40° C to 70° C), UL recognized.

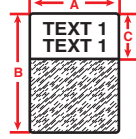

Figure 32

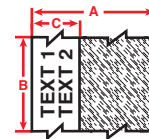

Figure 42b



Fits Printers	Figure	Catalog#	Color	Approx. Wire Gauge	Max Wire Dia. Inch (mm)	Label Width A Inch (mm)	Label Height B Inch (mm)	Print-On Height C Inch (mm)	Labels Per Roll	Sized To Fit	Ribbon in Cartridge
BMP41, 51, 53	Fig. 32	M-11-427	BK on WT	16 to 10	0.160 (4.1)	0.500 (12.7)	0.750 (19.1)	0.375 (9.5)	360	CAT-6, 4 pair UTP Copper	R4300
BMP41, 51, 53	Fig. 32	M-136-427	BK on WT	16 to 10	0.160 (4.1)	1.000 (25.4)	0.750 (19.1)	0.375 (9.5)	340	CAT-6, 4 pair UTP Copper	R4300
BMP41, 51, 53	Fig. 42b	MC-750-427	BK on WT	16 to 10	0.270 (6.7)	25 ft. (7.6 m)	0.750 (19.1)	0.375 (9.5)	1 roll (cont.)	CAT-6, 4 pair UTP Copper	R4300
BMP41, 51, 53	Fig. 32	M-47-427	BK on WT	12 to 10	0.210 (5.3)	1.000 (25.4)	0.500 (12.7)	0.375 (9.5)	360	2 pair Fiber/Coaxial, Single/Multi-Mode	R4300
BMP41, 51, 53	Fig. 32	M-48-427	BK on WT	12 to 10	0.210 (5.3)	0.750 (19.1)	1.000 (25.4)	0.375 (9.5)	200	CAT-6, 4 pair UTP Copper, Fiber, Coaxial	R4300
BMP41, 51, 53	Fig. 32	M-49-427	BK on WT	12 to 10	0.210 (5.3)	1.000 (25.4)	1.000 (25.4)	0.375 (9.5)	260	2 pair Fiber/Coaxial, Single/Multi-Mode	R4300
BMP41, 51, 53	Fig. 32	M-102-427	BK on WT	10 to 4	0.270 (6.7)	0.500 (12.7)	1.250 (31.7)	0.375 (9.5)	200	CAT-6, 4 pair UTP Copper	R4300
BMP41, 51, 53	Fig. 32	M-143-427	BK on WT	10 to 4	0.270 (6.7)	1.000 (25.4)	1.250 (31.7)	0.500 (12.7)	200	CAT-6, 4 pair UTP Copper, Fiber, Coaxial	R4300
BMP41, 51, 53	Fig. 32	M-89-427	BK on WT	10 to 4	0.320 (8.1)	0.500 (12.7)	1.500 (38.1)	0.500 (12.7)	180	CAT-6, 4 pair UTP Copper	R4300
BMP41, 51, 53	Fig. 32	M-90-427	BK on WT	10 to 4	0.320 (8.1)	0.750 (19.1)	1.500 (38.1)	0.500 (12.7)	180	CAT-6, 4 pair UTP Copper	R4300
BMP41, 51, 53	Fig. 32	M-91-427	BK on WT	10 to 4	0.320 (8.1)	1.000 (25.4)	1.500 (38.1)	0.500 (12.7)	180	CAT-6, 4 pair UTP Copper, Fiber, Coaxial	R4300
BMP41, 51, 53	Fig. 32	M-51-427	BK on WT	3 to 2/0	0.530 (13.5)	1.000 (25.4)	2.500 (63.5)	0.750 (19.1)	110	25 pair Copper, 4-12 pair Fiber, Coaxial	R4300
BMP41, 51, 53	Fig. 32	M-53-427	BK on WT	3/0 to 400 kcmil	0.850 (21.6)	1.000 (25.4)	4.000 (101.6)	1.000 (25.4)	70	50 pair Copper, 24 pair Fiber, Backbone	R4300
BMP41, 51, 53	Fig. 32	M-91-427-YL	BK on YL	10 to 4	0.320 (8.1)	1.000 (25.4)	1.500 (38.1)	0.500 (12.7)	180	CAT-6, 4 pair UTP Copper, Fiber, Coaxial	R4300
BMP41, 51, 53	Fig. 32	M-51-427-YL	BK on YL	3 to 2/0	0.530 (13.5)	1.000 (25.4)	2.500 (63.5)	0.750 (19.1)	110	25 pair Copper, 4-12 pair Fiber, Coaxial	R4300
BMP41, 51, 53	Fig. 32	M-53-427-YL	BK on YL	3/0 to 400 kcmil	0.850 (21.6)	1.000 (25.4)	4.000 (101.6)	1.000 (25.4)	70	50 pair Copper, 24 pair Fiber, Backbone	R4300

PermaSleeve[®] PS Polyolefin Wire Markers (B-342)

Military / industrial grade sleeves offer the ultimate in marker durability, permanence and aesthetic appearance. 3:1 heat-shrinkable markers fit snugly around wires, are fade-resistant and flame-retardant. Temp range: -67° F to 275° F (-55° C to 130° C). RoHS compliant and UL recognized.

Meets specifications:

- SSAE-AS-23053/5
- SAE-AS-81531

Tested per:

- ASTM E162
- ASTM E662
- MIL-STD-202

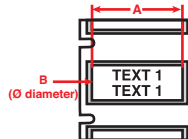

Figure 44

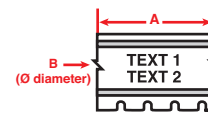

Figure 58



Fits Printers	Figure	Catalog #	B#	Color	Approx. Wire Gauge	Wire Diameter Range Inch (mm)	Supplied Diameter B Inch (mm)	Supplied Width A Inch (mm)	Sleeves Per Roll	Ribbon in Cartridge
BMP41, 51, 53	Fig. 44	* M-125-075-342	B-342	BK on WT	22 to 16	0.046 - 0.110 (1.2 - 2.8)	0.235 (5.9)	0.750 (19.1)	80	R4300
BMP41, 51, 53	Fig. 58	* MC-125-342	B-342	BK on WT	22 to 16	0.046 - 0.110 (1.2 - 2.8)	0.235 (5.9)	7 ft. (2.1 m)	1 roll (cont.)	R4300
BMP41, 51, 53	Fig. 44	* M-187-075-342	B-342	BK on WT	20 to 10	0.062 - 0.150 (1.6 - 3.8)	0.335 (8.5)	0.750 (19.1)	80	R4300
BMP41, 51, 53	Fig. 58	* MC-187-342	B-342	BK on WT	20 to 10	0.062 - 0.150 (1.6 - 3.8)	0.335 (8.5)	7 ft. (2.1 m)	1 roll (cont.)	R4300
BMP41, 51, 53	Fig. 44	* M-250-075-342	B-342	BK on WT	16 to 8	0.094 - 0.215 (2.4 - 5.5)	0.439 (11.1)	0.750 (19.1)	80	R4300
BMP41, 51, 53	Fig. 58	* MC-250-342	B-342	BK on WT	16 to 8	0.094 - 0.215 (2.4 - 5.5)	0.439 (11.1)	7 ft. (2.1 m)	1 roll (cont.)	R4300
BMP41, 51, 53	Fig. 44	* M-375-075-342	B-342	BK on WT	12 to 4	0.125 - 0.320 (3.2 - 8.1)	0.645 (16.4)	0.750 (19.1)	80	R4300
BMP41, 51, 53	Fig. 58	* MC1-375-342	B-342	BK on WT	12 to 4	0.125 - 0.320 (3.2 - 8.1)	0.645 (16.4)	7 ft. (2.1 m)	1 roll (cont.)	R4300
BMP41, 51, 53	Fig. 58	* MC-125-342-YL	B-342	BK on YL	22 to 16	0.046 - 0.110 (1.2 - 2.8)	0.235 (5.9)	7 ft. (2.1 m)	1 roll (cont.)	R4300
BMP41, 51, 53	Fig. 58	* MC-187-342-YL	B-342	BK on YL	20 to 10	0.062 - 0.150 (1.6 - 3.8)	0.335 (8.5)	7 ft. (2.1 m)	1 roll (cont.)	R4300
BMP41, 51, 53	Fig. 58	* MC-250-342-YL	B-342	BK on YL	16 to 8	0.094 - 0.215 (2.4 - 5.5)	0.439 (11.1)	7 ft. (2.1 m)	1 roll (cont.)	R4300

* **WARNING:** Cancer www.P65Warnings.ca.gov

Nylon Cloth Cable Flags (B-499)

Pre-formatted with two printable areas, allowing flag to be easily folded around wire to create a two-sided, printed flag. Nylon Cloth with permanent adhesive is pliable for rough or smooth surfaces. Temp. range: -94° F to 194° F (-70° C to 90° C). UL recognized.

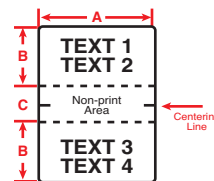

Figure 63



Fits Printers	Figure	Catalog #	B#	Material	Color	Label Width A Inch (mm)	Label Height B Inch (mm)	Non-Print Area Inch (mm)	Labels Per Roll	Ribbon in Cartridge
BMP41, 51, 53	Fig. 63	M-141-499	B-499	Nylon Cloth	BK on WT	1.000 (25.4)	1.000 (25.4)	0.250 (6.3)	90	R4300

Repositionable Adhesive Vinyl Cloth Wire and Cable Labels (B-498)

Printer automatically repeats your text to fill the label for maximum readability. The adhesive and cloth backing offers excellent holding power, yet allow for clean removal and repositioning if necessary. Temp. range -40° F to 175° F (-40° C to 70° C). UL recognized.

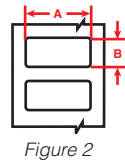

Fits Printers	Figure	Catalog #	B#	Material	Color	Approx. Wire Gauge	Max. Wire Dia. Inch (mm)	Label Width A Inch (mm)	Label Height B Inch (mm)	Labels Per Roll	Ribbon in Cartridge
BMP41, 51, 53	Fig. 2	M-7-498	B-498	Vinyl	BK on WT	22 to 16	0.110 (2.8)	0.500 (12.7)	0.500 (12.7)	240	R6200
BMP41, 51, 53	Fig. 2	M-11-498	B-498	Vinyl	BK on WT	16 to 10	0.160 (4.1)	0.750 (19.1)	0.500 (12.7)	220	R6200
BMP41, 51, 53	Fig. 2	M-48-498	B-498	Vinyl	BK on WT	12 to 10	0.210 (5.3)	1.000 (25.4)	0.750 (19.1)	180	R6200
BMP41, 51, 53	Fig. 2	M-49-498	B-498	Vinyl	BK on WT	12 to 10	0.210 (5.3)	1.000 (25.4)	1.000 (25.4)	160	R6200
BMP41, 51, 53	Fig. 2	M-131-498	B-498	Vinyl	BK on WT	10 to 4	0.270 (6.7)	1.000 (25.4)	0.500 (12.7)	180	R6200
BMP41, 51, 53	Fig. 2	M-91-498	B-498	Vinyl	BK on WT	10 to 4	0.270 (6.7)	1.500 (38.1)	1.000 (25.4)	120	R6200

Patch Panel, Punch Block, Desi Strip and Faceplate Labels (B-412 and B-422)

Create a fully formatted serialized punch block label to fit your equipment or label your ports, jacks and outlets with adhesive labels or slide-in strips.

- **B-412 Polypropylene Tags:** Non-adhesive slide-in strips
- **B-422 Polyester Material:** Permanent adhesive, good for powder-coated/textured surfaces. Temp. range: -40° F to 212° F (-40° C to 100° C). UL recognized.

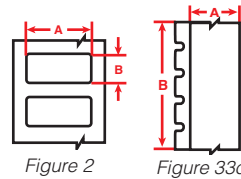

Fits Printers	Figure	Catalog #	B#	Material	Color	Label Width A Inch (mm)	Roll Length B Inch (mm)	Labels Per Roll	Ribbon in Cartridge
B-412 Non-Adhesive Polypropylene Tags									
BMP41, 51, 53	Fig. 33c	MC-375-412	B-412	Polypropylene	BK on WT	0.375 (9.5)	20 ft. (6.1 m)	1 roll (cont.)	R4300
BMP41, 51, 53	Fig. 33c	MC-475-412	B-412	Polypropylene	BK on WT	0.475 (12.1)	20 ft. (6.1 m)	1 roll (cont.)	R4300
BMP41, 51, 53	Fig. 33c	MC-625-412	B-412	Polypropylene	BK on WT	0.625 (15.8)	20 ft. (6.1 m)	1 roll (cont.)	R4300
B-422 Polyester Material									
BMP41, 51, 53	Fig. 33c	MC-375-422	B-422	Polyester	BK on WT	0.375 (9.5)	25 ft. (7.6 m)	1 roll (cont.)	R6000
BMP41, 51, 53	Fig. 33c	MC-475-422	B-422	Polyester	BK on WT	0.475 (12.1)	25 ft. (7.6 m)	1 roll (cont.)	R6000
BMP41, 51, 53	Fig. 2	M-7-422	B-422	Polyester	BK on WT	0.500 (12.7)	0.500 (12.7)	280	R6000
BMP41, 51, 53	Fig. 2	M-89-422	B-422	Polyester	BK on WT	0.500 (12.7)	1.500 (38.1)	180	R6000
BMP41, 51, 53	Fig. 2	M-90-422	B-422	Polyester	BK on WT	0.750 (19.1)	1.500 (38.1)	180	R6000
BMP41, 51, 53	Fig. 2	M-47-422	B-422	Polyester	BK on WT	1.000 (25.4)	0.500 (12.7)	480	R6000

Terminal Block Repositionable Adhesive Strips (B-498)

When using terminal block mode, printer can serialize and pre-space to your special thin widths to fit terminal blocks. The adhesive and cloth backing offers excellent holding power, yet allow for clean removal and repositioning if necessary. Temp. range -40° F to 175° F (-40° C to 70° C). UL recognized.

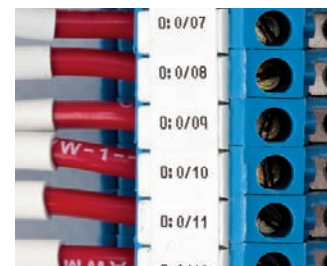
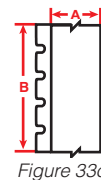

Fits Printers	Figure	Catalog #	B#	Material	Color	Label Width A Inch (mm)	Roll Length B Feet (m)	Labels Per Roll	Ribbon in Cartridge
BMP41, 51, 53	Fig. 33c	MC-240-498	B-498	Vinyl	BK on WT	0.240 (6.1)	16 (4.9)	1 roll (cont.)	R6200
BMP41, 51, 53	Fig. 33c	MC-318-498	B-498	Vinyl	BK on WT	0.318 (8.1)	16 (4.9)	1 roll (cont.)	R6200
BMP41, 51, 53	Fig. 33c	MC-375-498	B-498	Vinyl	BK on WT	0.375 (9.5)	20 (6.1)	1 roll (cont.)	R6200

BMP®51 Label Printer

BradyID.com/s36



Learn more at
BradyID.com/bmp51

Your complete printing solution:

BMP51 cartridges with label and print ribbon page 116

BMP®51 LABEL PRINTER

Made to get the job done

Print continuous and die-cut labels up to 1.5 in. wide and with more material options.

- Ribbon and label materials in one easy-to-load cartridge
- Prints 1.18 in. per second
- 200+ label parts in 14 materials
- 1.5 in. continuous output and 1 in. sleeves available
- Material recognition and automatic label formatting
- Large, graphical display with backlight
- Durable built-in cutter with label retention
- Robust software for advanced label design
- Optional Wi-Fi card for wireless printing via a network
- Tough, durable label materials that won't fade, smear or fall off

Printer specifications	
Print speed	1.18 in. / sec. (w/ AC adapter)
Print and color capabilities	Thermal Transfer / Monochrome
Print resolution	300 dpi
PC compatibility or standalone	Standalone and PC connect
Connectivity options	USB / Wi-Fi (field-installable), LAN
Software compatibility	Brady Workstation Apps, Brady Mobile Apps w/ Wi-Fi card, LabelMark™ Software
Power supply options	Li-Ion rechargeable battery, 8 AA batteries, AC adapter
Standard warranty	2 years
Dimensions	6 in. W x 10.3 in. H x 3.6 in. D
Weight	2.6 lbs. (w/o tape, batteries)
Print features	
Screen size	13 lines x 36 characters
Backlit screen	Yes
Keyboard style	QWERTY
Max print width	1.5 in.
Font types available	(2) Brady Alpine and Brady Fixed Width
Font sizes (pts)	Custom, auto, 4, 6, 7, 9, 10, 13, 14, 16, 20, 26, 28, 32, 38, 40, 42, 45, 51, 55, 60, 65, 70, 76, 102
Multi-line label capabilities	32
Label print rotation	Yes
Data serialization	Yes, multiple and linked
Barcode capabilities and types	Code 39, Code 128 and more using Brady Workstation
Memory capacity	25,000 characters up to 48 MB
Data transfer from PC	Yes
Print preview	Yes
Symbols available	450
Label supplies	
Label / ribbon supply	Cartridge w/ included ribbon
Material formats supported	Continuous and die-cut labels
Media width	0.25 in. to 1.5 in.
Types of materials	Outdoor vinyl, nylon cloth wire ID, heat-shrink wire ID, self-laminating wire ID, removable cloth wire ID, datacomm cable tags, standard polyester, aggressive adhesive polyester, metallized polyester, non-adhesive tag, outdoor reflective
Quantity of label parts available	200+ label parts
Cartridge series	M-series

BMP51 label printer and accessories

Catalog #	Description
BMP51	BMP51 Printer*, Rechargeable Li-Ion Battery Pack and AC Adaptor/Battery Charger
BMP51-KIT-AC	BMP51 Printer* with AC Adaptor/Battery Charger
Accessories	
M50-MAGNET	BMP50 Series Magnet Accessory
BMP-UBP	Lithium Ion Rechargeable Battery Pack
BMP-UBP-AC	Lithium Ion Rechargeable Battery Pack with AC Adaptor/Battery Charger
NET-LAN	Brady Network Card - Ethernet only
NET-Wi-Fi	Brady Network Card - Wi-Fi only
M50-HC	BMP50 Series Hard Carrying Case
BMP-SC-1	BMP50 Series Soft Carrying Case
M-AC-143110	BMP50 Series AC Adaptor/Battery Charger
M-USB-103788	BMP50 Series USB Cable
M50-BAT-TRAY	BMP50 Series Spare Battery Tray

* Printer ships with hard carrying case, battery tray for AA batteries, USB cable, drivers CD, product CD, quick start guide and one MC-1500-595-WT-BK label cartridge. Network card sold separately.

Patents applied for: 6,732,619 and 7,070,347 on printer. 6,929,415 on the PermaSleeve® wire marking cartridges. 8,542,155 on wireless and ethernet cards.



Get the job done faster, easier and with confidence

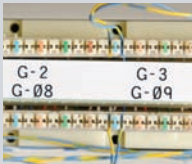

Voice and data communications



PermaSleeve® wire markers



Product identification



Panel component identification



Laboratory identification



General ID and much more

Portable Printers

BMP51



Brady Workstation Software

Desktop software for your Brady Printer

Brady Workstation has revolutionized how you design and print labels from your PC. When paired with the high-performance printing capabilities of a Brady printer, you get intuitive label set up for simple, efficient and flexible label creation.

- Suites designed with you in mind, contain apps for common safety and facility label designs, product and wire label creation, printing workflows and more
- Displays real-time information about the material installed for easy label set up
- Apps feature built-in regulations, standards, pictograms, common phrases, data importation guidance, help functions and more

▶ Learn more on page 176 or download a free trial at Workstation.Bradys.com

Brady Mobile Apps for On-The-Go Printing

We understand that you don't always have your PC with you to design labels. That's why we also offer two Brady Workstation Mobile Apps to enable you to quickly design labels on any iOS device, Android smartphone or Windows tablet, and print those labels with your BMP51 printer.*



- **Brady Workstation Mobile Text Labels** enables you to design professional text-only labels on the spot with your mobile device



- **Brady Workstation Mobile Print Partner** enables you to complete pre-defined fields with your mobile device using protected company label templates. Use Brady Workstation on a computer to create your own template and then open the template on your mobile device within the Brady Workstation Mobile Print Partner app from either a local disk (SD-card) or a cloud location, like Google Drive



*Brady Wi-Fi network card required to connect printer to mobile device.

Networking options

The BMP51 printer connects to your PC via the included USB cable. To avoid use of a physical cable, optional field-installable network cards are also available:



USB cable
(Included)



Ethernet only card
(Catalog#: NET-LAN)



Wi-Fi only card
required if printing
from mobile apps
(Catalog#: NET-WiFi)

BMP®53 label printer owners:

The BMP53 printer has been discontinued, but Brady continues to manufacture and stock label cartridges for use with your BMP53 printer.

View the following pages for available label cartridges.



Indoor and Outdoor Vinyl for Safety, Facility and Lean 5S (B-595)

Continuous vinyl material is ideal for lean 5S labels, pipe markers, equipment and production area identification. These labels offer excellent resistance to oils, detergents, dirt, grime and many solvents. Permanent adhesive, very pliable, good for rough surfaces and outdoor use. 8-10 years average outdoor durability.* Temp. range: -40° F to 180° F (-40° C to 82° C). UL recognized.



Figure 33



Fits Printers	Figure	Catalog #	B#	Material	Color	Label Width A Inch (mm)	Roll Length B Feet (m)	Labels Per Roll	Ribbon in Cartridge
BMP51, 53	Fig. 33	MC-250-595-WT-BK	B-595	Vinyl	Black on White	0.250 (6.35)	25 (7.62)	1 roll (cont.)	R10000
BMP41, 51, 53	Fig. 33	MC-375-595-WT-BK	B-595	Vinyl	Black on White	0.375 (9.5)	25 (7.62)	1 roll (cont.)	R6000
BMP41, 51, 53	Fig. 33	MC-500-595-WT-BK	B-595	Vinyl	Black on White	0.500 (12.70)	25 (7.62)	1 roll (cont.)	R6000
BMP41, 51, 53	Fig. 33	MC-750-595-WT-BK	B-595	Vinyl	Black on White	0.750 (19.10)	25 (7.62)	1 roll (cont.)	R6000
BMP41, 51, 53	Fig. 33	MC1-1000-595-WT-BK	B-595	Vinyl	Black on White	1.000 (25.40)	25 (7.62)	1 roll (cont.)	R6000
BMP51, 53	Fig. 33	MC-1500-595-WT-BK	B-595	Vinyl	Black on White	1.500 (38.10)	25 (7.62)	1 roll (cont.)	R6000
BMP51, 53	Fig. 33	MC-250-595-YL-BK	B-595	Vinyl	Black on Yellow	0.250 (6.35)	25 (7.62)	1 roll (cont.)	R10000
BMP41, 51, 53	Fig. 33	MC-375-595-YL-BK	B-595	Vinyl	Black on Yellow	0.375 (9.5)	25 (7.62)	1 roll (cont.)	R6000
BMP41, 51, 53	Fig. 33	MC-500-595-YL-BK	B-595	Vinyl	Black on Yellow	0.500 (12.70)	25 (7.62)	1 roll (cont.)	R6000
BMP41, 51, 53	Fig. 33	MC-750-595-YL-BK	B-595	Vinyl	Black on Yellow	0.750 (19.10)	25 (7.62)	1 roll (cont.)	R6000
BMP41, 51, 53	Fig. 33	MC1-1000-595-YL-BK	B-595	Vinyl	Black on Yellow	1.000 (25.40)	25 (7.62)	1 roll (cont.)	R6000
BMP51, 53	Fig. 33	MC-1500-595-YL-BK	B-595	Vinyl	Black on Yellow	1.500 (38.10)	25 (7.62)	1 roll (cont.)	R6000
BMP41, 51, 53	Fig. 33	MC-500-595-OR-BK	B-595	Vinyl	Black on Orange	0.500 (12.70)	25 (7.62)	1 roll (cont.)	R6000
BMP41, 51, 53	Fig. 33	MC-750-595-OR-BK	B-595	Vinyl	Black on Orange	0.750 (19.10)	25 (7.62)	1 roll (cont.)	R6000
BMP41, 51, 53	Fig. 33	MC1-1000-595-OR-BK	B-595	Vinyl	Black on Orange	1.000 (25.40)	25 (7.62)	1 roll (cont.)	R6000
BMP51, 53	Fig. 33	MC-1500-595-OR-BK	B-595	Vinyl	Black on Orange	1.500 (38.10)	25 (7.62)	1 roll (cont.)	R6000
BMP41, 51, 53	Fig. 33	MC-500-595-BL-WT	B-595	Vinyl	White on Blue	0.500 (12.70)	25 (7.62)	1 roll (cont.)	R4400
BMP41, 51, 53	Fig. 33	MC-750-595-BL-WT	B-595	Vinyl	White on Blue	0.750 (19.10)	25 (7.62)	1 roll (cont.)	R4400
BMP41, 51, 53	Fig. 33	MC1-1000-595-BL-WT	B-595	Vinyl	White on Blue	1.000 (25.40)	25 (7.62)	1 roll (cont.)	R4400
BMP51, 53	Fig. 33	MC-1500-595-BL-WT	B-595	Vinyl	White on Blue	1.500 (38.10)	25 (7.62)	1 roll (cont.)	R4400
BMP41, 51, 53	Fig. 33	MC-375-595-RD-WT	B-595	Vinyl	White on Red	0.375 (9.5)	25 (7.62)	1 roll (cont.)	R4400
BMP41, 51, 53	Fig. 33	MC-500-595-RD-WT	B-595	Vinyl	White on Red	0.500 (12.70)	25 (7.62)	1 roll (cont.)	R4400
BMP41, 51, 53	Fig. 33	MC-750-595-RD-WT	B-595	Vinyl	White on Red	0.750 (19.10)	25 (7.62)	1 roll (cont.)	R4400
BMP41, 51, 53	Fig. 33	MC1-1000-595-RD-WT	B-595	Vinyl	White on Red	1.000 (25.40)	25 (7.62)	1 roll (cont.)	R4400
BMP51, 53	Fig. 33	MC-1500-595-RD-WT	B-595	Vinyl	White on Red	1.500 (38.10)	25 (7.62)	1 roll (cont.)	R4400
BMP41, 51, 53	Fig. 33	MC-500-595-GN-WT	B-595	Vinyl	White on Green	0.500 (12.70)	25 (7.62)	1 roll (cont.)	R4400
BMP41, 51, 53	Fig. 33	MC-750-595-GN-WT	B-595	Vinyl	White on Green	0.750 (19.10)	25 (7.62)	1 roll (cont.)	R4400
BMP41, 51, 53	Fig. 33	MC1-1000-595-GN-WT	B-595	Vinyl	White on Green	1.000 (25.40)	25 (7.62)	1 roll (cont.)	R4400
BMP51, 53	Fig. 33	MC-1500-595-GN-WT	B-595	Vinyl	White on Green	1.500 (38.10)	25 (7.62)	1 roll (cont.)	R4400
BMP41, 51, 53	Fig. 33	MC-500-595-WT-RD	B-595	Vinyl	Red on White	0.500 (12.70)	25 (7.62)	1 roll (cont.)	R4400
BMP41, 51, 53	Fig. 33	MC-750-595-WT-RD	B-595	Vinyl	Red on White	0.750 (19.10)	25 (7.62)	1 roll (cont.)	R4400
BMP41, 51, 53	Fig. 33	MC1-1000-595-WT-RD	B-595	Vinyl	Red on White	1.000 (25.40)	25 (7.62)	1 roll (cont.)	R4400
BMP51, 53	Fig. 33	MC-1500-595-WT-RD	B-595	Vinyl	Red on White	1.500 (38.10)	25 (7.62)	1 roll (cont.)	R4400
BMP41, 51, 53	Fig. 33	MC-500-595-BK-WT	B-595	Vinyl	White on Black	0.500 (12.70)	25 (7.62)	1 roll (cont.)	R4400
BMP41, 51, 53	Fig. 33	MC-750-595-BK-WT	B-595	Vinyl	White on Black	0.750 (19.10)	25 (7.62)	1 roll (cont.)	R4400
BMP41, 51, 53	Fig. 33	MC1-1000-595-BK-WT	B-595	Vinyl	White on Black	1.000 (25.40)	25 (7.62)	1 roll (cont.)	R4400
BMP51, 53	Fig. 33	MC-1500-595-BK-WT	B-595	Vinyl	White on Black	1.500 (38.10)	25 (7.62)	1 roll (cont.)	R4400
BMP41, 51, 53	Fig. 33	MC-500-595-CL-BK	B-595	Vinyl	Black on Clear	0.500 (12.70)	20 (6.09)	1 roll (cont.)	R6000
BMP41, 51, 53	Fig. 33	MC-750-595-CL-BK	B-595	Vinyl	Black on Clear	0.750 (19.10)	20 (6.09)	1 roll (cont.)	R6000
BMP41, 51, 53	Fig. 33	MC1-1000-595-CL-BK	B-595	Vinyl	Black on Clear	1.000 (25.40)	20 (6.09)	1 roll (cont.)	R6000
BMP51, 53	Fig. 33	MC-1500-595-CL-BK	B-595	Vinyl	Black on Clear	1.500 (38.10)	20 (6.09)	1 roll (cont.)	R6000
BMP41, 51, 53	Fig. 33	MC-500-595-CL-WT	B-595	Vinyl	White on Clear	0.500 (12.70)	20 (6.09)	1 roll (cont.)	R4400
BMP41, 51, 53	Fig. 33	MC-750-595-CL-WT	B-595	Vinyl	White on Clear	0.750 (19.10)	20 (6.09)	1 roll (cont.)	R4400
BMP41, 51, 53	Fig. 33	MC1-1000-595-CL-WT	B-595	Vinyl	White on Clear	1.000 (25.40)	20 (6.09)	1 roll (cont.)	R4400
BMP51, 53	Fig. 33	MC-1500-595-CL-WT	B-595	Vinyl	White on Clear	1.500 (38.10)	20 (6.09)	1 roll (cont.)	R4400

* Average expected outdoor life of product will depend on user definition of failure, climatic conditions, mounting techniques and material color. The 8-10 year outdoor durability applies to the vinyl label stock only; ribbon durability will vary.

Inside-Panel Component Labels for Electrical, Automation and Data Centers (B-422, B-428, B-483, B-499 and B-595)

Variety of durable materials ideal for marking backer boards, DIN rail, relays, PLCs, switches and solenoids. Create serial or rating plates with barcodes, graphics and more with a flexible high-tack adhesive for easy and long-lasting adhesion.

- **B-422 Polyester Material:** Permanent adhesive, good for powder-coated and textured surfaces. Best on flat surfaces. Temp. range: -40° F to 212° F (-40° C to 100° C). UL recognized.
- **B-428 Metalized Polyester Material:** Permanent adhesive, silver finish. Temp. range: -40° F to 176° F (-40° C to 80° C). UL recognized.
- **B-483 Polyester Material:** Permanent adhesive for powder-coated and textured surfaces. Best on flat surfaces Temp. range: -40° F to 248° F (-40° C to 120° C). UL recognized.
- **B-499 Nylon Cloth Material:** Permanent adhesive. Pliable for rough or smooth surfaces. Temp. range: -94° F to 194° F (-70° C to 90° C). UL recognized.
- **B-595 Indoor / Outdoor Vinyl Material:** Permanent adhesive, very pliable, good for rough surfaces and outdoor use, wide range of colors. Temp. range: -40° F to 180° F (-40° C to 82° C). UL recognized.

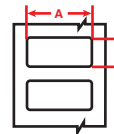

Figure 2

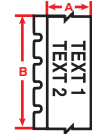

Figure 33

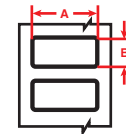

Figure 46 (with border)

Fits Printers	Figure	Catalog #	B#	Material	Color	Label Width A Inch (mm)	Label Height B Inch (mm)	Labels Per Roll	Ribbon in Cartridge
B-422 Gloss Polyester									
BMP41, 51, 53	Fig. 33	MC-375-422	B-422	Gloss Polyester	Black on White	0.375 (9.5)	25 ft. (7.6 m)	1 roll (cont.)	R6000
BMP41, 51, 53	Fig. 33	MC-475-422	B-422	Gloss Polyester	Black on White	0.475 (12.1)	25 ft. (7.6 m)	1 roll (cont.)	R6000
BMP41, 51, 53	Fig. 33	MC-500-422	B-422	Gloss Polyester	Black on White	0.500 (12.7)	25 ft. (7.6 m)	1 roll (cont.)	R6000
BMP41, 51, 53	Fig. 2	M-7-422	B-422	Gloss Polyester	Black on White	0.500 (12.70)	0.500 (12.70)	280	R6000
BMP41, 51, 53	Fig. 2	M-89-422	B-422	Gloss Polyester	Black on White	0.500 (12.70)	1.500 (38.10)	360	R6000
BMP41, 51, 53	Fig. 2	M-47-422	B-422	Gloss Polyester	Black on White	1.000 (25.40)	0.500 (12.70)	360	R6000
BMP41, 51, 53	Fig. 2	M-49-422	B-422	Gloss Polyester	Black on White	1.000 (25.40)	1.000 (25.40)	200	R6000
BMP41, 51, 53	Fig. 33	MC1-1000-422	B-422	Gloss Polyester	Black on White	1.000 (25.40)	25 ft. (7.62 m)	1 roll (cont.)	R6000
BMP41, 51, 53	Fig. 2	M-90-422	B-422	Gloss Polyester	Black on White	1.500 (38.10)	0.750 (19.05)	200	R6000
B-428 Metalized Polyester									
BMP51, 53	Fig. 2	M-29-428	B-428	Metalized Polyester	Light Gray	0.500 (12.70)	1.500 (38.10)	360	R4300
BMP51, 53	Fig. 2	M-30-428	B-428	Metalized Polyester	Light Gray	0.750 (19.05)	1.500 (38.10)	260	R4300
BMP41, 51, 53	Fig. 2	M-47-428	B-428	Metalized Polyester	Light Gray	1.000 (25.40)	0.500 (12.70)	360	R4300
BMP41, 51, 53	Fig. 46	M-92-428-BB	B-428	Metalized Polyester	Light Gray	1.130 (28.70)	0.500 (12.70)	360	R4300
BMP41, 51, 53	Fig. 2	M-60-428	B-428	Metalized Polyester	Light Gray	2.000 (50.80)	1.000 (25.40)	80	R4300
B-483 Ultra-Aggressive Polyester									
BMP41, 51, 53	Fig. 2	M-47-483	B-483	Polyester	Black on White	1.000 (25.4)	0.500 (12.7)	480	R6000
BMP41, 51, 53	Fig. 2	M-61-483	B-483	Polyester	Black on White	2.000 (50.80)	0.500 (12.70)	80	R6000
BMP41, 51, 53	Fig. 2	M-60-483	B-483	Polyester	Black on White	2.000 (50.80)	1.000 (25.40)	80	R6000
B-499 Nylon Cloth									
BMP41, 51, 53	Fig. 2	M-131-499	B-499	Nylon Cloth	Black on White	0.500 (12.7)	1.000 (25.40)	180	R4300
BMP41, 51, 53	Fig. 2	M-11-499	B-499	Nylon Cloth	Black on White	0.500 (12.70)	0.750 (19.05)	220	R4300
BMP41, 51, 53	Fig. 2	M-84-499	B-499	Nylon Cloth	Black on White	0.900 (22.86)	0.500 (12.70)	200	R4300
BMP41, 51, 53	Fig. 2	M-128-499	B-499	Nylon Cloth	Black on White	1.000 (25.40)	1.900 (48.3)	100	R4300
BMP51, 53	Fig. 2	M-132-499	B-499	Nylon Cloth	Black on White	1.500 (38.10)	1.250 (31.75)	160	R4300
B-595 Indoor / Outdoor Vinyl Tape*									
BMP41, 51, 53	Fig. 33	MC-500-595-WT-BK	B-595	Vinyl	Black on White	0.500 (12.70)	25 ft. (7.62 m)	1 roll (cont.)	R6000
BMP41, 51, 53	Fig. 33	MC1-1000-595-WT-BK	B-595	Vinyl	Black on White	1.000 (25.40)	25 ft. (7.62 m)	1 roll (cont.)	R6000
BMP41, 51, 53	Fig. 33	MC-500-595-YL-BK	B-595	Vinyl	Black on Yellow	0.500 (12.70)	25 ft. (7.62 m)	1 roll (cont.)	R6000
BMP41, 51, 53	Fig. 33	MC1-1000-595-YL-BK	B-595	Vinyl	Black on Yellow	1.000 (25.40)	25 ft. (7.62 m)	1 roll (cont.)	R6000
BMP41, 51, 53	Fig. 33	MC-500-595-OR-BK	B-595	Vinyl	Black on Orange	0.500 (12.70)	25 ft. (7.62 m)	1 roll (cont.)	R6000
BMP41, 51, 53	Fig. 33	MC1-1000-595-OR-BK	B-595	Vinyl	Black on Orange	1.000 (25.40)	25 ft. (7.62 m)	1 roll (cont.)	R6000

* For additional vinyl label colors, refer to the B-595 indoor / outdoor grade facility and safety labels on page 116.

Self-Laminating Vinyl Wire and Cable Labels (B-427)

Labels feature a clear, non-printable area that wraps around print-on area to protect text. Vinyl material offers superior resistance to handling, solvents, oil, grease, dirt and water. Temp. range -40° F to 158° F (-40° C to 70° C), UL recognized.

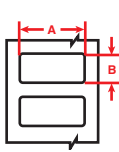

Figure 2

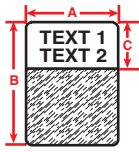

Figure 42

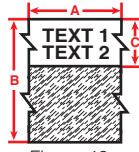

Figure 42a
(continuous)

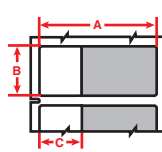

Figure 15c



Fits Printers	Figure	Catalog #	B#	Material	Color	Approx. Wire Gauge	Max. Wire Diameter Inch (mm)	Label Width A Inch (mm)	Label Height B Inch (mm)	Print-On Height C Inch (mm)	Labels Per Roll	Ribbon in Cartridge
B-427 Self-Laminating Vinyl												
BMP51, 53	Fig. 2	M-135-427-AW	B-427	Vinyl	BK on WT	All White	-	1.100 (27.9)	0.250 (6.35)	0.250 (6.35)	240	R4300
BMP41, 51, 53	Fig. 42	M-11-427	B-427	Vinyl	BK on WT	16 to 10	0.160 (4.06)	0.500 (12.70)	0.750 (19.05)	0.375 (9.53)	360	R4300
BMP41, 51, 53	Fig. 42	M-136-427	B-427	Vinyl	BK on WT	16 to 10	0.160 (4.06)	1.000 (25.40)	0.750 (19.05)	0.375 (9.53)	340	R4300
BMP41, 51, 53	Fig. 42	M-49-427	B-427	Vinyl	BK on WT	12 to 10	0.210 (5.33)	1.000 (25.40)	1.000 (25.40)	0.375 (9.53)	260	R4300
BMP51, 53	Fig. 42	M-133-427	B-427	Vinyl	BK on WT	12 to 10	0.210 (5.33)	1.750 (44.4)	1.000 (25.40)	0.375 (9.53)	140	R4300
BMP41, 51, 53	Fig. 42	M-102-427	B-427	Vinyl	BK on WT	10 to 4	0.270 (6.86)	0.500 (12.70)	1.250 (31.75)	0.375 (9.53)	200	R4300
BMP41, 51, 53	Fig. 42	M-143-427	B-427	Vinyl	BK on WT	10 to 4	0.270 (6.86)	1.000 (25.40)	1.250 (31.75)	0.500 (12.70)	200	R4300
BMP51, 53	Fig. 42	M-115-427	B-427	Vinyl	BK on WT	10 to 4	0.270 (6.86)	1.500 (38.10)	1.250 (31.75)	0.500 (12.70)	200	R4300
BMP41, 51, 53	Fig. 42	M-89-427	B-427	Vinyl	BK on WT	10 to 4	0.320 (8.13)	0.500 (12.70)	1.500 (38.10)	0.500 (12.70)	360	R4300
BMP41, 51, 53	Fig. 42	M-90-427	B-427	Vinyl	BK on WT	10 to 4	0.320 (8.13)	0.750 (19.05)	1.500 (38.10)	0.500 (12.70)	200	R4300
BMP41, 51, 53	Fig. 15c	M-47-427	B-427	Vinyl	BK on WT	12 to 10	0.210 (5.33)	1.000 (25.40)	0.500 (12.70)	0.375 (9.53)	360	R4300
BMP41, 51, 53	Fig. 15c	M-48-427	B-427	Vinyl	BK on WT	12 to 10	0.210 (5.33)	1.000 (25.40)	0.750 (19.05)	0.375 (9.53)	200	R4300
BMP41, 51, 53	Fig. 42	M-91-427	B-427	Vinyl	BK on WT	10 to 4	0.320 (8.13)	1.000 (25.40)	1.500 (38.10)	0.500 (12.70)	200	R4300
BMP51, 53	Fig. 42	M-32-427	B-427	Vinyl	BK on WT	10 to 4	0.320 (8.13)	1.500 (38.10)	1.500 (38.10)	0.500 (12.70)	180	R4300
BMP51, 53	Fig. 42	M-134-427	B-427	Vinyl	BK on WT	10 to 4	0.320 (8.13)	1.750 (44.4)	1.500 (38.10)	0.500 (12.70)	140	R4300
BMP41, 51, 53	Fig. 42	M-51-427	B-427	Vinyl	BK on WT	3 to 2/0	0.530 (13.46)	1.000 (25.40)	2.500 (63.50)	0.750 (19.05)	80	R4300
BMP51, 53	Fig. 42	M-116-427	B-427	Vinyl	BK on WT	3 to 2/0	0.530 (13.46)	1.500 (38.10)	2.500 (63.50)	0.750 (19.05)	80	R4300
BMP41, 51, 53	Fig. 42	M-53-427	B-427	Vinyl	BK on WT	3/0-400 kcmil	0.850 (21.59)	1.000 (25.40)	4.000 (101.6)	1.000 (25.40)	70	R4300
BMP51, 53	Fig. 42	M-33-427	B-427	Vinyl	BK on WT	3/0-400 kcmil	0.850 (21.59)	1.500 (38.10)	4.000 (101.6)	1.000 (25.40)	70	R4300
BMP51, 53	Fig. 42	M-34-427	B-427	Vinyl	BK on WT	3/0-400 kcmil	1.300 (33.02)	1.500 (38.10)	6.000 (152.40)	1.500 (38.10)	40	R4300
BMP41, 51, 53	Fig. 42	M-91-427-YL	B-427	Vinyl	BK on YL	10 to 4	0.320 (8.13)	1.000 (25.40)	1.500 (38.10)	0.500 (12.70)	200	R4300
BMP41, 51, 53	Fig. 42	M-51-427-YL	B-427	Vinyl	BK on YL	3 to 2/0	0.530 (13.46)	1.000 (25.40)	2.500 (63.50)	0.750 (19.05)	80	R4300
BMP41, 51, 53	Fig. 42	M-53-427-YL	B-427	Vinyl	BK on YL	3/0-400 kcmil	0.850 (21.59)	1.000 (25.40)	4.000 (101.6)	1.000 (25.40)	70	R4300
B-427 Continuous Self-Laminating Vinyl												
BMP41, 51, 53	Fig. 42a	MC-750-427	B-427	Vinyl	BK on WT	16 to 10	0.270 (6.86)	25 ft. (7.62 m)	0.750 (19.05)	0.375 (9.53)	1 roll (cont.)	R4300
BMP51, 53	Fig. 42a	MC-1000-427	B-427	Vinyl	BK on WT	12 to 10	0.850 (21.59)	25 ft. (7.62 m)	1.000 (25.40)	0.375 (9.53)	1 roll (cont.)	R4300
BMP51, 53	Fig. 42a	MC-1250-427	B-427	Vinyl	BK on WT	10 to 4	0.530 (13.46)	25 ft. (7.62 m)	1.250 (31.75)	0.500 (12.70)	1 roll (cont.)	R4300
BMP51, 53	Fig. 42a	MC-1500-427	B-427	Vinyl	BK on WT	10 to 4	0.270 (6.86)	25 ft. (7.62 m)	1.500 (38.10)	0.500 (12.70)	1 roll (cont.)	R4300

Repositionable Adhesive Vinyl Cloth Wire and Cable Labels (B-498)

Printer automatically repeats your text to fill the label for maximum readability. The adhesive and cloth backing offer excellent holding power, yet allow for clean removal and repositioning if necessary. Temp. range -40° F to 175° F (-40° C to 70° C). UL recognized.

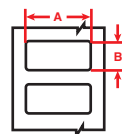

Figure 2



Fits Printers	Figure	Catalog #	B#	Material	Color	Approx. Wire Gauge	Max. Wire Dia. Inch (mm)	Label Width A Inch (mm)	Label Height B Inch (mm)	Labels Per Roll	Ribbon in Cartridge
BMP41, 51, 53	Fig. 2	M-7-498	B-498	Vinyl Cloth	BK on WT	22 to 16	0.110 (2.80)	0.500 (12.70)	0.500 (12.70)	240	R6200
BMP41, 51, 53	Fig. 2	M-11-498	B-498	Vinyl Cloth	BK on WT	16 to 10	0.160 (4.00)	0.750 (19.05)	0.500 (12.70)	220	R6200
BMP41, 51, 53	Fig. 2	M-131-498	B-498	Vinyl Cloth	BK on WT	12 to 10	0.210 (5.00)	0.500 (12.70)	1.000 (25.40)	180	R6200
BMP41, 51, 53	Fig. 2	M-48-498	B-498	Vinyl Cloth	BK on WT	12 to 10	0.210 (5.00)	0.750 (19.05)	1.000 (25.40)	180	R6200
BMP41, 51, 53	Fig. 2	M-163-498	B-498	Vinyl Cloth	BK on WT	12 to 10	0.210 (5.00)	1.000 (25.40)	0.500 (12.70)	180	R6200
BMP41, 51, 53	Fig. 2	M-49-498	B-498	Vinyl Cloth	BK on WT	12 to 10	0.210 (5.00)	1.000 (25.40)	1.000 (25.40)	160	R6200
BMP51, 53	Fig. 2	M-103-498	B-498	Vinyl Cloth	BK on WT	10 to 4	0.270 (7.00)	1.000 (25.40)	1.250 (31.75)	160	R6200
BMP41, 51, 53	Fig. 2	M-91-498	B-498	Vinyl Cloth	BK on WT	10 to 4	0.270 (7.00)	1.000 (25.40)	1.500 (38.10)	160	R6200
BMP51, 53	Fig. 2	M-128-498	B-498	Vinyl Cloth	BK on WT	10 to 4	0.270 (7.00)	1.000 (25.40)	1.900 (48.3)	100	R6200

PermaSleeve® PS Polyolefin Wire Markers (B-342)

Military / industrial grade sleeves offer the ultimate in marker durability, permanence and aesthetic appearance. 3:1 heat-shrinkable markers fit snugly around wires, are fade-resistant and flame-retardant. Temp range: -67° F to 275° F (-55° C to 130° C). RoHS compliant and UL recognized.

Meets specifications:

- SSAE-AS-23053/5
- SAE-AS-81531

Tested per:

- ASTM E162
- ASTM E662
- MIL-STD-202

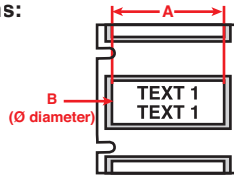

Figure 44

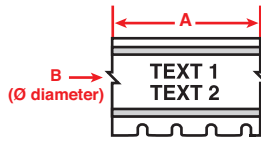

Figure 58



Fits Printers	Figure	Catalog #	B#	Color	Approx. Wire Gauge	For Wire Diameter		Sleeve Width A Inch (mm)	Supplied Diameter B Inch (mm)	Sleeves Per Roll	Ribbon in Cartridge
						Min.	Max				
B-342 Die-Cut Sleeve											
BMP41, 51, 53	Fig. 44	* M-125-075-342	B-342	BK on WT	22 to 16	0.046 - 0.110	(1.20 - 2.80)	0.750 (19.1)	0.235 (5.97)	80	R4300
BMP51, 53	Fig. 44	* M-125-1-342	B-342	BK on WT	22 to 16	0.046 - 0.110	(1.20 - 2.80)	1.000 (25.40)	0.235 (5.97)	80	R4300
BMP41, 51, 53	Fig. 44	* M-187-075-342	B-342	BK on WT	20 to 10	0.062 - 0.150	(1.60 - 3.80)	0.750 (19.1)	0.335 (8.51)	80	R4300
BMP51, 53	Fig. 44	* M-187-1-342	B-342	BK on WT	20 to 10	0.062 - 0.150	(1.60 - 3.80)	1.000 (25.40)	0.335 (8.51)	80	R4300
BMP41, 51, 53	Fig. 44	* M-250-075-342	B-342	BK on WT	16 to 8	0.094 - 0.215	(2.40 - 5.50)	0.750 (19.1)	0.439 (11.15)	80	R4300
BMP51, 53	Fig. 44	* M-250-1-342	B-342	BK on WT	16 to 8	0.094 - 0.215	(2.40 - 5.50)	1.000 (25.40)	0.439 (11.15)	80	R4300
BMP41, 51, 53	Fig. 44	* M-375-075-342	B-342	BK on WT	12 to 4	0.125 - 0.320	(3.20 - 8.10)	0.750 (19.1)	0.645 (16.38)	80	R4300
BMP51, 53	Fig. 44	* M-375-1-342	B-342	BK on WT	12 to 4	0.125 - 0.320	(3.20 - 8.10)	1.000 (25.40)	0.645 (16.38)	80	R4300
B-342 Continuous Sleeve											
BMP41, 51, 53	Fig. 58	* MC-125-342	B-342	BK on WT	22 to 16	0.046 - 0.110	(1.20 - 2.80)	7 ft. (2.13 m)	0.235 (5.97)	1 roll (cont.)	R4300
BMP41, 51, 53	Fig. 58	* MC-187-342	B-342	BK on WT	20 to 10	0.062 - 0.150	(1.60 - 3.80)	7 ft. (2.13 m)	0.335 (8.51)	1 roll (cont.)	R4300
BMP41, 51, 53	Fig. 58	* MC-250-342	B-342	BK on WT	16 to 8	0.094 - 0.215	(2.40 - 5.50)	7 ft. (2.13 m)	0.439 (11.15)	1 roll (cont.)	R4300
BMP41, 51, 53	Fig. 58	* MC1-375-342	B-342	BK on WT	12 to 4	0.125 - 0.320	(3.20 - 8.10)	7 ft. (2.13 m)	0.645 (16.38)	1 roll (cont.)	R4300
BMP41, 51, 53	Fig. 58	* MC-125-342-YL	B-342	BK on YL	22 to 16	0.046 - 0.110	(1.20 - 2.80)	7 ft. (2.13 m)	0.235 (5.97)	1 roll (cont.)	R4300
BMP41, 51, 53	Fig. 58	* MC-187-342-YL	B-342	BK on YL	20 to 10	0.062 - 0.150	(1.60 - 3.80)	7 ft. (2.13 m)	0.335 (8.51)	1 roll (cont.)	R4300
BMP41, 51, 53	Fig. 58	* MC-250-342-YL	B-342	BK on YL	16 to 8	0.094 - 0.215	(2.40 - 5.50)	7 ft. (2.13 m)	0.439 (11.15)	1 roll (cont.)	R4300

* **WARNING:** Cancer www.P65Warnings.ca.gov

Wire and Cable Flags and Tags (B-109, B-145, B-425 and B-499)

Allow more legible information on data cables and smaller diameter wires. Permits you to handle and view labels without touching the wires.

- **B-109 Non-Adhesive Polyethylene Tags:** Multi-purpose tags for identifying multi-conductor cables. Good weatherability and legibility after solvent exposure.
- **B-145 Polyethylene Tag Material:** Multi-purpose matte material for tag applications. Ideal for identifying multi-conductor cable, inventory, equipment, lockout, safety warning repair and work-in progress.
- **B-425 Polypropylene Solvent Resistant Material:** Matte white polypropylene with excellent solvent resistance and print performance; not recommended for long-term outdoor use.
- **B-499 Nylon Cloth Material:** Permanent adhesive. Pliable for rough or smooth surfaces. Temp. range: -94° F to 194° F (-70° C to 90° C). UL recognized.

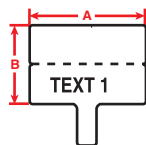

Figure 48

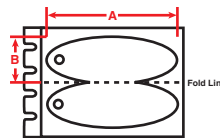

Figure 50

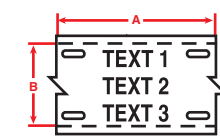

Figure 57

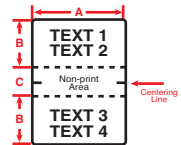

Figure 63

Fits Printers	Figure	Catalog #	B#	Material	Color	Label Width A Inch (mm)	Label Height B Inch (mm)	Label Height C Inch (mm)	Labels Per Roll	Ribbon in Cartridge
B-109 Polyethylene Tag										
BMP51, 53	Fig. 57	M-12-109	B-109	Polypropylene Tag	Black on White	3.000 (76.2)	0.750 (19.05)	-	80	R4300
B-145 Polypropylene Tag										
BMP51, 53	Fig. 50	M-111-145FR-GY	B-145	Polyethylene Tag	Black on Gray	1.206 (30.63)	0.750 (19.05)	-	80	R6000
B-425 Polypropylene Flag										
BMP51, 53	Fig. 48	MFT-01-425	B-425	Polypropylene Flag	Black on White	0.788 (20.01)	1.18 (29.97)	-	200	R4300
B-499 Nylon Cloth										
BMP41, 51, 53	Fig. 63	M-141-499	B-499	Nylon Cloth	Black on White	1.000 (25.40)	1.000 (25.40)	0.250 (6.35)	90	R4300
BMP51, 53	Fig. 63	M-152-499	B-499	Nylon Cloth	Black on White	1.500 (38.10)	0.500 (12.70)	0.250 (6.35)	160	R4300

Terminal Block Repositionable Adhesive Strips (B-498)

When using terminal block mode, printer can serialize and pre-space to your special thin widths to fit terminal blocks. The adhesive and cloth backing offers excellent holding power, yet allow for clean removal and repositioning if necessary. Temp. range -40° F to 175° F (-40° C to 70° C). UL recognized.



Figure 33

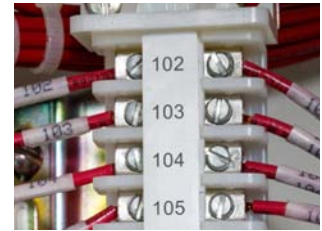

Fits Printers	Figure	Catalog #	B#	Material	Color	Label Width A Inch (mm)	Roll Length B Foot (m)	Labels Per Roll	Ribbon in Cartridge
BMP41, 51, 53	Fig. 33	MC-240-498	B-498	Vinyl Cloth	Black on White	0.240 (6.09)	16 (4.87)	1 roll (cont.)	R6200
BMP41, 51, 53	Fig. 33	MC-318-498	B-498	Vinyl Cloth	Black on White	0.318 (8.07)	16 (4.87)	1 roll (cont.)	R6200
BMP41, 51, 53	Fig. 33	MC-375-498	B-498	Vinyl Cloth	Black on White	0.375 (9.52)	20 (6.1)	1 roll (cont.)	R6200

Patch Panel, Punch Block, Desi Strip and Faceplate Labels (B-412, B-422 and B-483)

Create a fully formatted serialized punch block label to fit your equipment or label your ports, jacks and outlets with adhesive labels or slide-in strips.

- **B-412 Polypropylene Tags:** Non-adhesive slide-in strips.
- **B-422 Polyester Material:** Permanent adhesive, good for powder-coated and textured surfaces. Temp. range: -40° F to 212° F (-40° C to 100° C). UL recognized.
- **B-483 Polyester Material:** Permanent adhesive for powder-coated and textured surfaces. Best on flat surfaces. Temp. range: -40° F to 248° F (-40° C to 120° C). UL recognized.

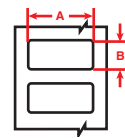

Figure 2

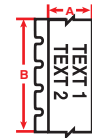
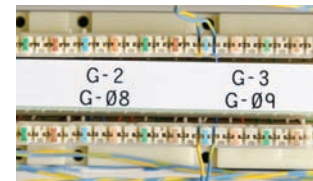

Figure 33



Fits Printers	Figure	Catalog #	B#	Material	Color	Label Width A Inch (mm)	Label Height B Inch (mm)	Labels Per Roll	Material Notes	Ribbon in Cartridge
B-412 Polypropylene Tag										
BMP41, 51, 53	Fig. 33	MC-375-412	B-412	Tag	Black on white	0.375 (9.53)	20 ft. (6.09 m)	1 roll (cont.)	Non-adhesive slide-in strips	R4300
BMP41, 51, 53	Fig. 33	MC-475-412	B-412	Tag	Black on white	0.475 (12.07)	20 ft. (6.09 m)	1 roll (cont.)	Non-adhesive slide-in strips	R4300
BMP41, 51, 53	Fig. 33	MC-625-412	B-412	Tag	Black on white	0.675 (12.07)	20 ft. (6.09 m)	1 roll (cont.)	Non-adhesive slide-in strips	R4300
B-422 Gloss Polyester										
BMP41, 51, 53	Fig. 33	MC-375-422	B-422	Polyester	Black on white	0.375 (9.5)	25 ft. (7.6 m)	1 roll (cont.)	Adhesive strips	R6000
BMP41, 51, 53	Fig. 33	MC-475-422	B-422	Polyester	Black on white	0.475 (12.1)	25 ft. (7.6 m)	1 roll (cont.)	Adhesive strips	R6000
BMP41, 51, 53	Fig. 33	MC-625-422	B-422	Polyester	Black on white	0.675 (12.07)	25 ft. (7.62 m)	1 roll (cont.)	Adhesive strips	R6000
BMP41, 51, 53	Fig. 2	M-7-422	B-422	Polyester	Black on white	0.500 (12.70)	0.500 (12.70)	280	Individual adhesive port labels	R6000
BMP41, 51, 53	Fig. 2	M-89-422	B-422	Polyester	Black on white	0.500 (12.70)	1.500 (38.10)	360	Individual adhesive labels	R6000
BMP41, 51, 53	Fig. 2	M-47-422	B-422	Polyester	Black on white	1.000 (25.40)	0.500 (12.70)	360	Individual adhesive labels	R6000
BMP41, 51, 53	Fig. 2	M-90-422	B-422	Polyester	Black on white	1.500 (38.10)	0.750 (19.05)	200	Individual adhesive labels	R6000
B-483 Ultra-Aggressive Polyester										
BMP41, 51, 53	Fig. 2	M-61-483	B-483	Polyester	Black on white	2.000 (50.80)	0.500 (12.70)	80	Individual adhesive labels	R6000

BMP51 cartridges

The necessary print ribbons for the BMP51 Label Printer are self-contained within the label roll cartridge. No need to order or load separate print ribbons.



Polyester Labels for Rating Plates and General ID (B-422, B-428, B-432 and B-483)

Standard and metallized labels ideal for labeling rating plates, products and general industrial applications.

- B-422 Polyester Material:** Permanent adhesive, good for powder-coated and textured surfaces. Best on flat surfaces. Temp. range: -40° F to 212° F (-40° C to 100° C). UL recognized.
- B-428 Metallized Polyester Material:** Permanent adhesive, silver finish. Temp. range: -40° F to 176° F (-40° C to 80° C). UL recognized.
- B-432 Polyester Material:** Durable glossy white polyester with permanent acrylic adhesive. Labels are chemical, oil and water resistant. Temp. range: -40° F to 212° F (-40° C to 100° C). UL recognized.
- B-483 Polyester Material:** Permanent adhesive for powder-coated and textured surfaces. Best on flat surfaces Temp. range: -40° F to 248° F (-40° C to 120° C). UL recognized.

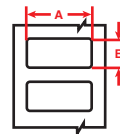

Figure 2



Figure 33

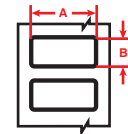

Figure 46 (with border)

Fits Printers	Figure	Catalog #	B#	Material	Color	Label Width A Inch (mm)	Label Height B Inch (mm)	Labels Per Roll	Ribbon in Cartridge
B-422 Gloss Polyester									
BMP41, 51, 53	Fig. 33	MC-375-422	B-422	Gloss Polyester	Black on White	0.375 (9.5)	25 ft. (7.6 m)	1 roll (cont.)	R6000
BMP41, 51, 53	Fig. 33	MC-475-422	B-422	Gloss Polyester	Black on White	0.475 (12.1)	25 ft. (7.6 m)	1 roll (cont.)	R6000
BMP41, 51, 53	Fig. 2	M-7-422	B-422	Gloss Polyester	Black on White	0.500 (12.70)	0.500 (12.70)	280	R6000
BMP41, 51, 53	Fig. 2	M-89-422	B-422	Gloss Polyester	Black on White	0.500 (12.70)	1.500 (38.10)	360	R6000
BMP41, 51, 53	Fig. 33	MC-500-422	B-422	Gloss Polyester	Black on White	0.500 (12.7)	25 ft. (7.6 m)	1 roll (cont.)	R6000
BMP41, 51, 53	Fig. 2	M-47-422	B-422	Gloss Polyester	Black on White	1.000 (25.40)	0.500 (12.70)	360	R6000
BMP41, 51, 53	Fig. 2	M-49-422	B-422	Gloss Polyester	Black on White	1.000 (25.40)	1.000 (25.40)	200	R6000
BMP41, 51, 53	Fig. 33	MC1-1000-422	B-422	Gloss Polyester	Black on White	1.000 (25.40)	25ft. (7.62m)	1 roll (cont.)	R6000
BMP41, 51, 53	Fig. 2	M-90-422	B-422	Gloss Polyester	Black on White	1.500 (38.10)	0.750 (19.05)	200	R6000
B-428 Metallized Polyester									
BMP51, 53	Fig. 2	M-29-428	B-428	Metallized Polyester	Light Gray	0.500 (12.70)	1.500 (38.10)	360	R4300
BMP51, 53	Fig. 2	M-30-428	B-428	Metallized Polyester	Light Gray	0.750 (19.05)	1.500 (38.10)	260	R4300
BMP41, 51, 53	Fig. 46	M-92-428-BB	B-428	Metallized Polyester	Light Gray	1.130 (28.70)	0.500 (12.70)	360	R4300
BMP41, 51, 53	Fig. 2	M-60-428	B-428	Metallized Polyester	Light Gray	2.000 (50.80)	1.000 (25.40)	80	R4300
B-432 Gloss Polyester									
BMP51, 53	Fig. 2	M-17-432-CL-BK	B-432	Gloss Polyester	Black on Clear	1.000 (25.40)	0.500 (12.70)	280	R6000
BMP51, 53	Fig. 2	M-78-432-CL-BK	B-432	Gloss Polyester	Black on Clear	1.900 (48.3)	1.000 (25.40)	100	R6000
B-483 Ultra-Aggressive Polyester									
BMP41, 51, 53	Fig. 2	M-47-483	B-483	Polyester	Black on White	1.000 (25.4)	0.500 (12.7)	360	R6000
BMP41, 51, 53	Fig. 2	M-61-483	B-483	Polyester	Black on White	2.000 (50.80)	0.500 (12.70)	80	R6000
BMP41, 51, 53	Fig. 2	M-60-483	B-483	Polyester	Black on White	2.000 (50.80)	1.000 (25.40)	80	R6000

Reflective Labels (B-584)

Reflective material shines back brightly when struck by light, making it ideal for labeling outdoor utility poles, hard hats, jobsite equipment and roof-top equipment. Meets Federal Spec L-S-300 for reflectivity. Average outdoor durability is 4-6 years. Temp. range: -40° F to 158° F (-40° C to 70° C).

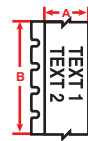

Figure 33



Fits Printers	Figure	Catalog #	B#	Material	Color	Label Width A Inch (mm)	Roll Length B Feet (m)	Labels Per Roll	Ribbon in Cartridge
BMP41, 51, 53	Fig.33	MC-500-584	B-584	Reflective Tape	Black on White	0.500 (12.70)	25 (7.62)	1 roll (cont.)	R6000
BMP41, 51, 53	Fig.33	MC-750-584	B-584	Reflective Tape	Black on White	0.750 (19.05)	25 (7.62)	1 roll (cont.)	R6000
BMP41, 51, 53	Fig.33	MC-1000-584	B-584	Reflective Tape	Black on White	1.000 (25.40)	25 (7.62)	1 roll (cont.)	R6000
BMP51, 53	Fig.33	MC-1500-584	B-584	Reflective Tape	Black on White	1.500 (38.10)	25 (7.62)	1 roll (cont.)	R6000
BMP41, 51, 53	Fig.33	MC-500-584-YL	B-584	Reflective Tape	Black on Yellow	0.500 (12.70)	25 (7.62)	1 roll (cont.)	R6000
BMP41, 51, 53	Fig.33	MC-750-584-YL	B-584	Reflective Tape	Black on Yellow	0.750 (19.05)	25 (7.62)	1 roll (cont.)	R6000
BMP41, 51, 53	Fig.33	MC-1000-584-YL	B-584	Reflective Tape	Black on Yellow	1.000 (25.40)	25 (7.62)	1 roll (cont.)	R6000
BMP51, 53	Fig.33	MC-1500-584-YL	B-584	Reflective Tape	Black on Yellow	1.500 (38.10)	25 (7.62)	1 roll (cont.)	R6000

Bin, Storage and General Industrial Labels (B-483, B-499 and B-595)

Several materials with an aggressive adhesive for use in commercial and industrial applications.

- **B-483 Polyester Material:** Permanent adhesive for powder-coated and textured surfaces. Best on flat surfaces Temp. range: -40° F to 248° F (-40° C to 120° C). UL recognized.
- **B-499 Nylon Cloth Material:** Permanent adhesive. Pliable for rough or smooth surfaces. Temp. range: -94° F to 194° F (-70° C to 90° C). UL recognized.
- **B-595 Indoor / Outdoor Vinyl Material:** Permanent adhesive, very pliable, good for rough surfaces and outdoor use. Temp. range: -40° F to 180° F (-40° C to 82° C). UL recognized.

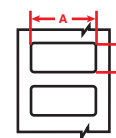

Figure 2



Figure 3

Fits Printers	Figure	Catalog #	B#	Material	Color	Label Width A Inch (mm)	Label Height B Inch (mm)	Labels Per Roll	Ribbon in Cartridge
B-483 Ultra-Aggressive Polyester									
BMP41, 51, 53	Fig. 2	M-47-483	B-483	Polyester	Black on White	1.000 (25.4)	0.500 (12.7)	360	R6000
BMP41, 51, 53	Fig. 2	M-61-483	B-483	Polyester	Black on White	2.000 (50.80)	0.500 (12.70)	80	R6000
BMP41, 51, 53	Fig. 2	M-60-483	B-483	Polyester	Black on White	2.000 (50.80)	1.000 (25.40)	80	R6000
B-499 Nylon Cloth									
BMP41, 51, 53	Fig. 2	M-11-499	B-499	Nylon Cloth	Black on White	0.500 (12.70)	0.750 (19.05)	220	R4300
BMP41, 51, 53	Fig. 2	M-84-499	B-499	Nylon Cloth	Black on White	0.900 (22.86)	0.500 (12.70)	200	R4300
BMP41, 51, 53	Fig. 2	M-128-499	B-499	Nylon Cloth	Black on White	1.000 (25.40)	1.900 (48.3)	100	R4300
BMP51, 53	Fig. 2	M-132-499	B-499	Nylon Cloth	Black on White	1.500 (38.10)	1.250 (31.75)	160	R4300
B-595 Indoor / Outdoor Vinyl Tape*									
BMP41, 51, 53	Fig. 33	MC-750-595-WT-BK	B-595	Vinyl	Black on White	0.750 (19.10)	25 ft. (7.62 m)	1 roll (cont.)	R6000
BMP41, 51, 53	Fig. 33	MC1-1000-595-WT-BK	B-595	Vinyl	Black on White	1.000 (25.40)	25 ft. (7.62 m)	1 roll (cont.)	R6000
BMP51, 53	Fig. 33	MC-1500-595-WT-BK	B-595	Vinyl	Black on White	1.500 (38.10)	25 ft. (7.62 m)	1 roll (cont.)	R6000
BMP41, 51, 53	Fig. 33	MC-750-595-YL-BK	B-595	Vinyl	Black on Yellow	0.750 (19.10)	25 ft. (7.62 m)	1 roll (cont.)	R6000
BMP41, 51, 53	Fig. 33	MC1-1000-595-YL-BK	B-595	Vinyl	Black on Yellow	1.000 (25.40)	25 ft. (7.62 m)	1 roll (cont.)	R6000
BMP51, 53	Fig. 33	MC-1500-595-YL-BK	B-595	Vinyl	Black on Yellow	1.500 (38.10)	25 ft. (7.62 m)	1 roll (cont.)	R6000

* For additional vinyl label colors, refer to the B-595 indoor / outdoor grade facility and safety labels on page 116.

Tamper-Indicating Vinyl Labels (B-351)

Destructible vinyl material prohibits one piece removal of label to indicate if the label has been tampered with.

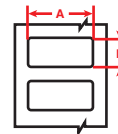

Figure 2



Fits Printers	Figure	Catalog #	B#	Material	Color	Label Width A Inch (mm)	Label Height B Inch (mm)	Labels Per Roll	Ribbon in Cartridge
BMP51, 53	Fig. 2	M-17-351	B-351	Vinyl	Black on White	0.500 (12.70)	1.000 (25.40)	360	R6000
BMP51, 53	Fig. 2	M-20-351	B-351	Vinyl	Black on White	2.000 (50.80)	1.000 (25.40)	160	R6000

Water Dissolvable Paper Labels (B-403)

Paper material completely dissolves in warm water within 30 seconds, leaving no adhesive residue.



Figure 33



Fits Printers	Figure	Catalog #	B#	Material	Color	Label Width A Inch (mm)	Roll Length B Feet (m)	Labels Per Roll	Rec. Ribbon
BMP51, 53	Fig. 33	MC-750-403	B-403	Dissolvable Paper	Black on White	0.750 (19.05)	25 (7.62)	1 roll (cont.)	R4300
BMP51, 53	Fig. 33	MC-1500-403	B-403	Dissolvable Paper	Black on White	1.500 (38.1)	25 (7.62)	1 roll (cont.)	R4300

Cryogenic Tube, Vial and Cane Labels (B-461, B-490 and B-492)

FreezerBondz™ labels can be applied to room temperature or already frozen samples, with a small overlap. The label remains legible and will stick to the tube during processing, even when immersed in liquid- or vapor-phase nitrogen or placed in ultra-low temperature freezer storage.

- **B-461 Self-Laminating Polyester Material:** Ultra-thin polyester label with clear overlaminating tail that protects print and allows liquid levels to be visible.
- **B-490 Polyester Material:** White FreezerBondz label ideal for flat, frozen surfaces. Adheres to frozen tubes and vials when wrapped around itself by at least 0.125 inch.
- **B-492 Polyester Material:** FreezerBondz ultra-thin white polyester label for labeling of frosted/frozen or room temperature vials, tubes and canes. Superior chemical and abrasion resistance.

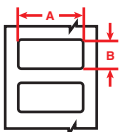

Figure 2

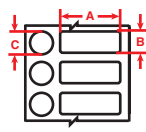

Figure 24

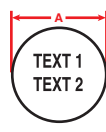

Figure 26

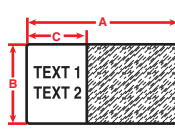

Figure 27

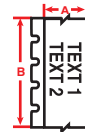

Figure 33

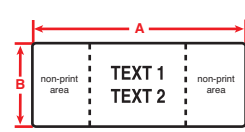

Figure 66

Fits Printers	Figure	Catalog #	B#	Material	Color	Label Width A Inch (mm)	Label Height B Inch (mm)	Print-On Height C Inch (mm)	Labels Per Roll	Ribbon in Cartridge
B-461 Self-Laminating Polyester										
BMP51, 53	Fig. 27	M-123-461	B-461	Self-Lam Polyester	Black on White	1.125 (28.5)	0.375 (9.5)	0.750 (19.0)	360	R4300
BMP51, 53	Fig. 27	M-122-461	B-461	Self-Lam Polyester	Black on White	1.125 (28.5)	0.500 (12.7)	0.750 (19.0)	360	R4300
BMP51, 53	Fig. 27	M-124-461	B-461	Self-Lam Polyester	Black on White	1.650 (41.9)	0.500 (12.7)	0.750 (19.0)	180	R4300
BMP41, 51, 53	Fig. 27	M-72-461	B-461	Self-Lam Polyester	Black on White	1.750 (44.4)	0.500 (12.7)	0.750 (19.0)	180	R4300
BMP51, 53	Fig. 27	M-74-461	B-461	Self-Lam Polyester	Black on White	2.200 (55.8)	0.500 (12.7)	0.750 (19.0)	140	R4300
BMP51, 53	Fig. 27	M-125-461	B-461	Self-Lam Polyester	Black on White	1.750 (44.4)	1.000 (25.4)	1.000 (25.4)	180	R4300
BMP51, 53	Fig. 27	M-126-461	B-461	Self-Lam Polyester	Black on White	1.800 (45.7)	0.600 (45.7)	1.000 (25.4)	180	R4300
BMP51, 53	Fig. 27	M-126-461	B-461	Self-Lam Polyester	Black on White	1.800 (45.7)	0.600 (45.7)	1.000 (25.4)	180	R4300
BMP51, 53	Fig. 27	M-75-461	B-461	Self-Lam Polyester	Black on White	2.625 (66.6)	0.375 (9.5)	1.000 (25.4)	120	R4300
BMP51, 53	Fig. 27	M-86-461	B-461	Self-Lam Polyester	Black on White	2.625 (66.6)	0.600 (45.7)	1.000 (25.4)	120	R4300
BMP51, 53	Fig. 27	M-129-461	B-461	Self-Lam Polyester	Black on White	2.250 (57.1)	1.500 (38.1)	1.250 (31.7)	140	R4300
BMP51, 53	Fig. 27	M-119-461	B-461	Self-Lam Polyester	Black on White	3.750 (95.3)	1.500 (38.1)	1.250 (31.7)	80	R4300
BMP51, 53	Fig. 33	MC-375-461	B-461	Self-Lam Polyester	Black on White	0.375 (9.5)	25 ft. (7.62 m)	-	1 roll (cont.)	R4300
BMP51, 53	Fig. 33	MC-500-461	B-461	Self-Lam Polyester	Black on White	0.500 (12.7)	25 ft. (7.6 m)	-	1 roll (cont.)	R4300
BMP51, 53	Fig. 33	MC-1000-461	B-461	Self-Lam Polyester	Black on White	1.000 (25.4)	25 ft. (7.6 m)	-	1 roll (cont.)	R4300
BMP51, 53	Fig. 33	MC-1250-461	B-461	Self-Lam Polyester	Black on White	1.250 (31.7)	25 ft. (7.6 m)	-	1 roll (cont.)	R4300
B-490 FreezerBondz Polyester										
BMP51, 53	Fig. 2	M-114-490	B-490	Polyester	Black on White	0.500 (12.7)	3.750 (9.2)	-	80	R4300
BMP51, 53	Fig. 2	M-112-490	B-490	Polyester	Black on White	1.250 (31.7)	0.375 (9.5)	-	360	R4300
BMP51, 53	Fig. 2	M-112-490	B-490	Polyester	Black on White	1.250 (31.7)	0.375 (9.5)	-	360	R4300
BMP51, 53	Fig. 2	M-113-490	B-490	Polyester	Black on White	1.500 (38.1)	2.200 (55.9)	-	140	R4300
BMP51, 53	Fig. 2	M-124-490	B-490	Polyester	Black on White	1.650 (41.9)	0.500 (12.7)	-	180	R4300
BMP51, 53	Fig. 2	M-125-490	B-490	Polyester	Black on White	1.750 (44.4)	1.000 (25.4)	-	180	R4300
BMP51, 53	Fig. 2	M-126-490	B-490	Polyester	Black on White	1.800 (45.7)	0.600 (45.7)	-	180	R4300
BMP51, 53	Fig. 2	M-126-490	B-490	Polyester	Black on White	1.800 (45.7)	0.600 (45.7)	-	180	R4300
B-492 FreezerBondz Polyester										
BMP51, 53	Fig. 24	M-118-492	B-492	Polyester	Black on White	1.000 (25.4)	0.375 (9.5)	0.375 (9.5) dia.	240	R6400
BMP51, 53	Fig. 24	M-120-492	B-492	Polyester	Black on White	1.000 (25.4)	0.500 (12.7)	0.375 (9.5) dia.	240	R6400
BMP51, 53	Fig. 24	M-117-492	B-492	Polyester	Black on White	1.000 (25.4)	0.500 (12.7)	0.440 (11.1) dia.	240	R6400
BMP51, 53	Fig. 26	M-82-492	B-492	Polyester	Black on White	0.375 (9.5) dia.	-	-	240	R6400
BMP51, 53	Fig. 26	M-83-492	B-492	Polyester	Black on White	0.500 (12.7) dia.	-	-	240	R6400
BMP51, 53	Fig. 33	MC-500-492	B-492	Polyester	Black on White	0.500 (12.7)	25 ft. (7.6 m)	-	1 roll (cont.)	R6400
BMP51, 53	Fig. 2	M-130-492	B-492	Polyester	Black on White	0.825 (20.9)	0.375 (9.5)	-	220	R6400
BMP51, 53	Fig. 2	M-130-492	B-492	Polyester	Black on White	0.825 (20.9)	0.375 (9.5)	-	220	R6400
BMP51, 53	Fig. 2	M-156-492	B-492	Polyester	Black on White	0.900 (22.8)	1.000 (25.4)	-	180	R6400
BMP51, 53	Fig. 2	M-156-492	B-492	Polyester	Black on White	0.900 (22.8)	1.000 (25.4)	-	180	R6400
BMP51, 53	Fig. 2	M-131-492	B-492	Polyester	Black on White	1.000 (25.4)	0.500 (12.7)	-	180	R6400
BMP51, 53	Fig. 2	M-131-492	B-492	Polyester	Black on White	1.000 (25.4)	0.500 (12.7)	-	180	R6400
BMP51, 53	Fig. 66	M-155-492	B-492	Polyester	Black on White	1.250 (31.7)	0.250 (6.3)	-	180	R6400
BMP51, 53	Fig. 2	M-78-492	B-492	Polyester	Black on White	1.900 (48.2)	1.000 (25.4)	-	100	R6400

Microscope Slide Labels (B-481 and B-488)

StainerBondz™ Labels are designed specifically to identify slides and to resist exposure to harsh chemicals during the slide staining process. They perform well in stains such as hematoxylin and eosin.

- **B-481 StainerBondz Polyester:** White polyester with extreme chemical resistance and withstands the rigors of typical deparaffinization, including ethanol, xylene and H and E staining process.
- **B-488 StainerBondz Polyester:** White polyester with moderate chemical resistance for short-term exposure to xylene, DMSO and ethanol.

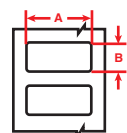

Figure 2



Fits Printers	Figure	Catalog #	B#	Material	Color	Label Width A Inch (mm)	Label Height B Inch (mm)	Labels Per Roll	Ribbon in Cartridge
B-481 Polyester with extreme chemical-resistance									
BMP51, 53	Fig. 2	M-195-481	B-481	Polyester	Black on White	0.900 (22.8)	0.375 (9.5)	320	R6400
BMP51, 53	Fig. 2	M-194-481	B-481	Polyester	Black on White	0.900 (22.8)	0.750 (19.1)	320	R6400
BMP51, 53	Fig. 2	M-97-481	B-481	Polyester	Black on White	0.900 (22.8)	0.900 (22.9)	280	R6400
B-488 Polyester with moderate chemical-resistance									
BMP51, 53	Fig. 2	M-97-488	B-488	Polyester	Black on White	0.900 (22.8)	0.900 (22.9)	280	R4300
BMP51, 53	Fig. 2	M-81-488	B-488	Polyester	Black on White	1.900 (48.2)	0.250 (6.3)	160	R4300

Microcentrifuge and PCR Tube Labels (B-499 and B-7425)

Designed with ultra-thin material that prevents vials from jamming in centrifuges or racks. These labels withstand harsh temperatures and chemicals without falling off, fading or smearing.

- **B-499 Nylon Cloth:** Thick white nylon cloth for easy handling and conformability.
- **B-7425 Polypropylene:** Ideal for labeling dry, room temperature specimen containers. Temp. range: -196° C to 121° C (-320° F to 248° F). Chemical resistance to ethanol, DMSO, IPS, short term xylene, 10% formalin, 50% acetic acid and toluene.

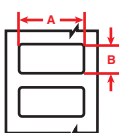

Figure 2

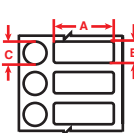

Figure 24

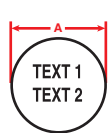

Figure 26

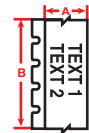

Figure 33



Fits Printers	Figure	Catalog #	B#	Material	Color	Label Width A Inch (mm)	Label Height B Inch (mm)	Label Dia. C Inch (mm)	Labels Per Roll	Ribbon in Cartridge
B-499 Nylon Cloth										
BMP51, 53	Fig. 24	M-118-499	B-499	Nylon Cloth	Black on White	1.000 (25.4)	0.375 (9.5)	0.375 (9.5) dia.	240	R4300
BMP51, 53	Fig. 24	M-120-499	B-499	Nylon Cloth	Black on White	1.000 (25.4)	0.500 (12.7)	0.375 (9.5) dia.	240	R4300
BMP51, 53	Fig. 24	M-117-499	B-499	Nylon Cloth	Black on White	1.000 (25.4)	0.500 (12.7)	0.440 (11.1) dia.	240	R4300
BMP51, 53	Fig. 33	MC-1000-499	B-499	Nylon Cloth	Black on White	1.000 (25.4)	16 ft. (4.8 m)	-	1 roll (cont.)	R4300
BMP51, 53	Fig. 26	M-82-499	B-499	Nylon Cloth	Black on White	0.375 (9.5) dia.	-	-	240	R4300
BMP51, 53	Fig. 26	M-83-499	B-499	Nylon Cloth	Black on White	0.500 (12.7) dia.	-	-	240	R4300
BMP51, 53	Fig. 26	M-82-499-OR-BK	B-499	Nylon Cloth	Black on Orange	0.375 (9.5) dia.	-	-	240	R4300
BMP51, 53	Fig. 26	M-83-499-OR-BK	B-499	Nylon Cloth	Black on Orange	0.500 (12.7) dia.	-	-	240	R4300
BMP51, 53	Fig. 26	M-82-499-RD-BK	B-499	Nylon Cloth	Black on Red	0.375 (9.5) dia.	-	-	240	R4300
BMP51, 53	Fig. 26	M-83-499-RD-BK	B-499	Nylon Cloth	Black on Red	0.500 (12.7) dia.	-	-	240	R4300
BMP51, 53	Fig. 26	M-82-499-YL-BK	B-499	Nylon Cloth	Black on Yellow	0.375 (9.5) dia.	-	-	240	R4300
BMP51, 53	Fig. 26	M-83-499-YL-BK	B-499	Nylon Cloth	Black on Yellow	0.500 (12.7) dia.	-	-	240	R4300
B-7425 Polypropylene										
BMP51, 53	Fig. 24	M-118-7425	B-7425	Polypropylene	Black on White	1.000 (25.4)	0.375 (9.5)	0.375 (9.5) dia.	240	R4300
BMP51, 53	Fig. 2	M-31-7425	B-7425	Polypropylene	Black on White	1.500 (38.10)	1.000 (25.4)	-	250	R4300

Tissue Cassette Labels (B-482 and B-498)

- **B-482 Polyester Material:** White polyester label with superior resistance to tissue processing chemicals and embedding procedures. Use with the BSP™31 Label Attachment System for pre-process tissue cassette ID.
- **B-498 Repositionable Vinyl Cloth Material:** Removable white vinyl cloth for re-identification of post-process tissue cassettes or general lab applications. Can be applied directly onto the cassettes or on top of previous label.

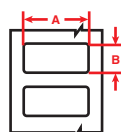

Figure 2



Fits Printers	Figure	Catalog #	B#	Material	Color	Label Width A Inch (mm)	Label Height B Inch (mm)	Labels Per Roll	Ribbon in Cartridge
BMP51, 53	Fig. 2	M-127-482	B-482	Polyester	Black on White	1.05 (26.6)	0.250 (6.3)	360	R6400
BMP41, 51, 53	Fig. 2	M-11-498	B-498	Vinyl Cloth	Black on White	0.750 (12.7)	0.500 (19.1)	220	R6200

Color Polyester Labels (B-494)

Gloss white polyester with a color border printed on the label allows for differentiation of test specimens within user processes. Vial top labels are solid color. Resistant to common lab chemicals like ethanol and xylene.

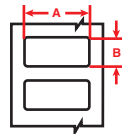

Figure 2

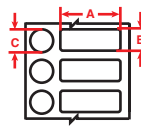

Figure 24



Fits Printers	Figure	Catalog #	B#	Material	Color	Label Width A Inch (mm)	Label Height B Inch (mm)	Secondary Label C Inch (mm)	Labels Per Roll	Ribbon in Cartridge
BMP51	Fig. 24	M-118-494-BL	B-494	Polyester	Black on Blue	1.000 (25.4)	0.375 (9.5)	0.375 (9.5)	240	R6400
BMP51	Fig. 24	M-120-494-BL	B-494	Polyester	Black on Blue	1.000 (25.4)	0.500 (12.7)	0.375 (9.5)	240	R6400
BMP51	Fig. 2	M-131-494-BL	B-494	Polyester	Black on Blue	1.000 (25.4)	0.500 (12.7)	-	180	R6400
BMP51	Fig. 2	M-49-494-BL	B-494	Polyester	Black on Blue	1.000 (25.4)	1.000 (25.4)	-	260	R6400
BMP51	Fig. 24	M-118-494-GN	B-494	Polyester	Black on Green	1.000 (25.4)	0.375 (9.5)	0.375 (9.5)	240	R6400
BMP51	Fig. 24	M-120-494-GN	B-494	Polyester	Black on Green	1.000 (25.4)	0.500 (12.7)	0.375 (9.5)	240	R6400
BMP51	Fig. 2	M-131-494-GN	B-494	Polyester	Black on Green	1.000 (25.4)	0.500 (12.7)	-	180	R6400
BMP51	Fig. 2	M-49-494-GN	B-494	Polyester	Black on Green	1.000 (25.4)	1.000 (25.4)	-	260	R6400
BMP51	Fig. 24	M-118-494-OR	B-494	Polyester	Black on Orange	1.000 (25.4)	0.375 (9.5)	0.375 (9.5)	240	R6400
BMP51	Fig. 24	M-120-494-OR	B-494	Polyester	Black on Orange	1.000 (25.4)	0.500 (12.7)	0.375 (9.5)	240	R6400
BMP51	Fig. 2	M-131-494-OR	B-494	Polyester	Black on Orange	1.000 (25.4)	0.500 (12.7)	-	180	R6400
BMP51	Fig. 2	M-49-494-OR	B-494	Polyester	Black on Orange	1.000 (25.4)	1.000 (25.4)	-	260	R6400
BMP51	Fig. 24	M-118-494-PK	B-494	Polyester	Black on Pink	1.000 (25.4)	0.375 (9.5)	0.375 (9.5)	240	R6400
BMP51	Fig. 24	M-120-494-PK	B-494	Polyester	Black on Pink	1.000 (25.4)	0.500 (12.7)	0.375 (9.5)	240	R6400
BMP51	Fig. 2	M-131-494-PK	B-494	Polyester	Black on Pink	1.000 (25.4)	0.500 (12.7)	-	180	R6400
BMP51	Fig. 2	M-49-494-PK	B-494	Polyester	Black on Pink	1.000 (25.4)	1.000 (25.4)	-	260	R6400
BMP51	Fig. 24	M-118-494-RD	B-494	Polyester	Black on Red	1.000 (25.4)	0.375 (9.5)	0.375 (9.5)	250	R6400
BMP51	Fig. 24	M-120-494-RD	B-494	Polyester	Black on Red	1.000 (25.4)	0.500 (12.7)	0.375 (9.5)	240	R6400
BMP51	Fig. 2	M-131-494-RD	B-494	Polyester	Black on Red	1.000 (25.4)	0.500 (12.7)	-	180	R6400
BMP51	Fig. 2	M-49-494-RD	B-494	Polyester	Black on Red	1.000 (25.4)	1.000 (25.4)	-	260	R6400
BMP51	Fig. 24	M-118-494-YL	B-494	Polyester	Black on Yellow	1.000 (25.4)	0.375 (9.5)	0.375 (9.5)	240	R6400
BMP51	Fig. 24	M-120-494-YL	B-494	Polyester	Black on Yellow	1.000 (25.4)	0.500 (12.7)	0.375 (9.5)	240	R6400
BMP51	Fig. 2	M-131-494-YL	B-494	Polyester	Black on Yellow	1.000 (25.4)	0.500 (12.7)	-	180	R6400
BMP51	Fig. 2	M-49-494-YL	B-494	Polyester	Black on Yellow	1.000 (25.4)	1.000 (25.4)	-	260	R6400



Get the job done for less with a Printer Starter Kit

Voice and DataComm Starter Kit

Kit includes:

- Hard case, USB cable and AC power supply
- Self-laminating cable markers (M-21-427)
- Port, faceplate and general ID labels (M-30-422)
- Non-adhesive slide-in strips for punch blocks (MC-475-412)
- Rack and panel labels (MC-1000-595-YL-BK)
- 1.5 in. white label roll for general ID (MC-1500-595-WT-BK)

Catalog #	Description
BMP51-KIT-VD	Starter Kit with BMP51 Label Printer and Li-Ion Battery

Electrical ID Starter Kit

Kit includes:

- Hard case, USB cable and AC power supply
- Self-laminating wire markers (M-103-427)
- Wrap around wire markers (M-18-498)
- PermaSleeve® PS Heat-Shrink Wire Markers (M-187-1-342)
- Panel identification labels (MC-1500-595-OR-BK)
- 1.5 in. white label roll for general ID (MC-1500-595-WT-BK)

Catalog #	Description
BMP51-KIT-EL	Starter Kit with BMP51 Label Printer and Li-Ion Battery

Facility ID Starter Kit

Kit includes:

- Hard case, USB cable and AC power supply
- 1.5 in. yellow label roll with black ribbon (MC-1500-595-YL-BK)
- 1.5 in. white label roll with red ribbon (MC-1500-595-WT-RD)
- 1.5 in. green label roll with white ribbon (MC-1500-595-GN-WT)
- 1.5 in. white label roll with black ribbon (MC-1500-595-WT-BK)
- 2 in. x 1 in. labels for low surface energy labeling (M-20-483)

Catalog #	Description
BMP51-KIT-GI	Starter Kit with BMP51 Label Printer and Li-Ion Battery

Lab ID Starter Kit

Kit includes:

- Hard case, USB cable and AC power supply
- Vial and tube labels (M-156-492)
- Microplate labels (M-81-488)
- Top and side label set for vials and tubes (M-120-492)
- Removable die-cut labels for bottles, beakers, etc. (M-103-498)
- 1.5 in. white label roll for general ID (MC-1500-595-WT-BK)

Catalog #	Description
BMP51-KIT-LS	Starter Kit with BMP51 Label Printer and Li-Ion Battery

BradyPrinter M611 Label Printer

BradyID.com/s36



BRADY360
2 YEAR
WARRANTY

Learn more at
BradyID.com/m611

Your complete printing solution:

BradyPrinter M611 label rolls .. page 130
BradyPrinter M611 ribbons page 150

BradyPrinter M611 printer and accessories

Catalog #	Description
M611-AM-BT-W	BradyPrinter M611 Bluetooth / Wi-Fi AC*
M611-BC-KIT1**	BradyPrinter M611* with (1) R6010 ribbon and (2) rolls of 1 in. x 2 in. B-432 labels
BMP-MAGNET-2	Magnet for BradyPrinter M611
BMP-HC-2	Hard case for BradyPrinter M611
BMP-PACK-2	Sling pack for BradyPrinter M611
BMP-STRAP-1	Carrying strap
BMP-SC-2	Soft case
M-AC-143110	AC adapter and battery charger
PCK-5	Cleaning kit 5-pack

* Printer ships with AC adapter / battery charger, USB 2.0 cable, utility strap, PTL-97-488 label material, M61-R4310 ribbon and USB flash drive with product information.

Printer requires the Brady Workstation Express Labels Mobile App or Brady Workstation Desktop Software (free downloads)



BradyPrinter M611

MOBILE LABEL PRINTER

Your durable print-from-everywhere solution

The BradyPrinter M611 Mobile Printer, powered by Brady Workstation Software, combines the convenience of your mobile device with the dependable printing capabilities of a Brady printer. This complete solution provides you with a variety of time- and labor-saving advantages, including:

- **Print-from-everywhere capabilities:** Whether you're in the office or in the field, you can easily get your data and keep on printing
- **Fast-to-label software:** Create and edit labels in the field with Brady Workstation Express Labels Mobile App so you can complete the job right the first time
- **On-the-job durability:** Keep printing all day with the long-lasting battery and rugged design
- **Industry-tested materials:** Complete your identification jobs with materials that last

Printer specifications	
Print speed	1.33 in. / sec.
Print and color capabilities	Thermal Transfer / Monochrome
Print resolution	300 dpi
PC compatibility or standalone	Peripheral only, no keyboard
Connectivity options	Bluetooth, Wi-Fi, USB 2.0
Software compatibility	Required. Brady Workstation Express Labels Mobile App (IOS / Android) or Brady Workstation Desktop
Power supply options	Rechargeable Li-Ion, AC power / battery charger / car charger
Standard warranty	2 years
Dimensions	10.974 in. L x 4.459 in. W x 4.553 in. H
Weight	3.52 lbs. (with supplied media and ribbon)
Print features	
Screen size	Custom LCD, color, 3.5 in. QVGA
Backlit screen	Yes
Keyboard style	None
Max print width	1.92 in.
Font types available	Driven by software
Font sizes (pts)	Driven by software
Multi-line label capabilities	Driven by software
Label print rotation	Driven by software
Data serialization	Driven by software
Barcode capabilities and types	Driven by software
Memory capacity	512 MB RAM / 256 MB Flash
Data transfer from PC	Driven by software
Print preview	No
Symbols available	Driven by software
Label supplies	
Label / ribbon supply	Separate label roll and ribbon cartridges
Material formats supported	Continuous, die-cut labels and custom
Media width	0.235 to 2.00 in.
Types of materials	General purpose industrial vinyl, heat-shrink wire ID, self-laminating wire ID, removable cloth wire ID, datacomm cable tags, standard polyester, aggressive adhesive polyester, metallized polyester non-adhesive tag, polyimide / electronics materials, tamper resistant materials, raised panel labels (engraved plate alternative)
Quantity of label parts available	600+ label parts and customs
Cartridge series	BPTL, BPTDS, BPSPT, BPTLTB, PTL, PSHT, PTLEP, PTS, PTLFP, PSPT, PTPSL, PSFR, PTPS, PTLSL, BM71, BM61, M61, M61C, custom available

Your durable print-from-everywhere solution

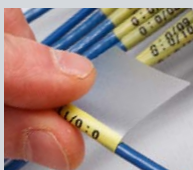

Wire and cable marking



PermaSleeve® wire markers



Control panel labels

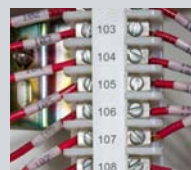

Patch panel and terminal block ID



Circuit board ID



Facility and safety ID and many more

Portable Printers

M611 / BMP61

Keep printing everywhere

Forget the days of wasting time driving back and forth between the office and the jobsite to get new labels for every identification project. The complete BradyPrinter M611 Mobile Label Printer and Brady Workstation Software solution bridges the printing gap between the office and the field. With this combination of mobile software and mobile print connectivity, you get the freedom to push data from the office to the field so your field engineers have everything they need to complete the task at hand. After the job is complete, rely on the high performance of Brady materials to provide long-lasting identification.

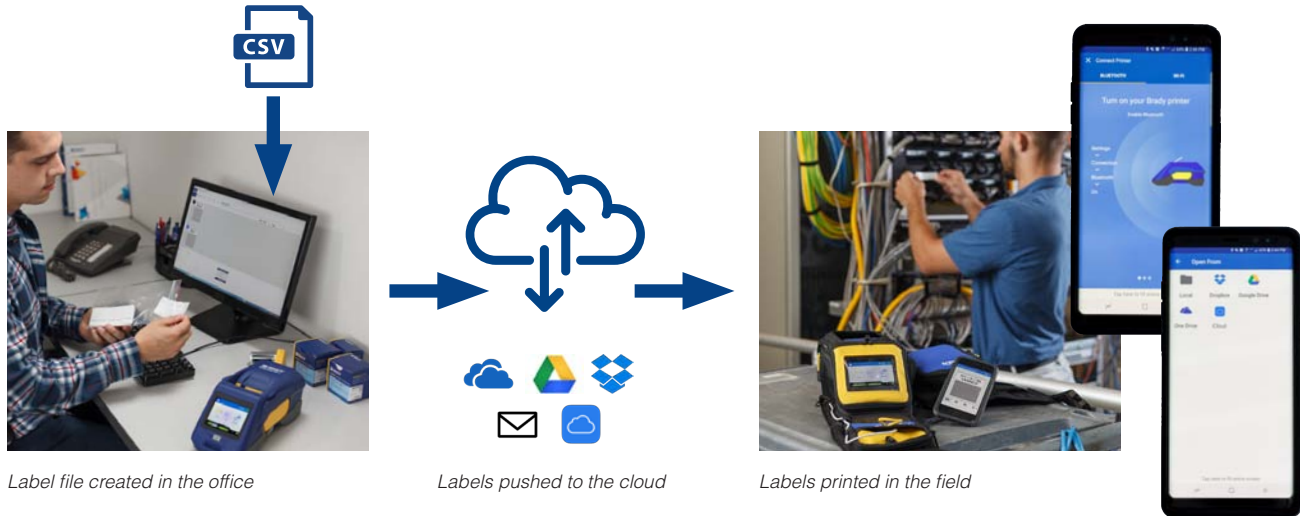

new

**Your one-stop shop
for mobile printing**

The Brady Workstation Express Labels Mobile App makes mobile printing convenient and simple. This intuitively designed software integrates touchscreen technology for fast and easy label creation, including label resizing using touch and a native keyboard for more natural typing. To make label creation even more convenient, the app features auto-save capabilities, tools to help you easily enter data onto your label and easy-to-use editing tools to keep labeling projects moving smoothly.

BradyPrinter M611 Sling Pack

(Catalog Number: BMP-PACK-2)

This convenient carryall can be used as a full on-the-go print station – with compartments sized to fit your phone, materials and cords so you can keep everything you need together.



Portable Printers

M611 / BMP61

BMP®61 Label Printer

BradyID.com/s36

Portable Printers

M611 / BMP61



BMP®61 LABEL PRINTER

Performance that matches your own

The BMP61 Label Printer is designed for quick and efficient identification of wires, cables and components.

- Simple user interface with easy menu, cursor and label navigation
- Large, color touchscreen display to see exactly what the label is going to look like before it's printed
- Die-cut, continuous and custom label supplies up to 2 in. wide (51 mm)
- Data connectivity with a USB 2.0 port (Type A and B) and a USB flash drive so users can save, import and export label files, lists and graphics
- Rugged design with rubber bumpers and tested to survive a 4-foot drop
- Power options include rechargeable NiMH battery or AC power to keep you printing wherever you go

Learn more at BradyID.com/bmp61

Your complete printing solution:

BMP61 label rolls page 130
BMP61 ribbons page 150

BMP61 label printer and accessories

Catalog #	Description
BMP61-W	BMP61 Label Printer* with Wi-Fi
BMP61	BMP61 Label Printer*
M611-BC-KIT1	BMP61 Label Printer* with (1) R6010 ribbon and (2) rolls of 1 in. x 2 in. B-432 labels
Accessories	
BMP-HC-1	Hardcase Accessory
BMP-SC-2	Soft case
BMP-STRAP-1	Carrying Strap
BMP-MAGNET-1	Magnet Accessory
M-AC-143110	AC Adapter / Battery Charger
BMP41-QC	External Battery Quick Charger
BMP41-BATT	Rechargeable NiMH Battery
BMP61-BATCOV	Battery Cover
BMP61-W-BATCOV	Battery Cover for Wi-Fi Printer
BMP61-CUTTER	Cutter Accessory
PCK-5	Cleaning Kit 5-Pack

* Printer ships with AC adapter / battery charger, NiMH rechargeable battery, USB cord, utility strap, hardcase, PTL-19-423 label material, M61-R6010 ribbon, quick start guide and USB flash drive with product information.



Printer specifications	
Print speed	1.33 in. / sec
Print and color capabilities	Thermal Transfer / Monochrome
Print resolution	300 dpi
PC compatibility or standalone	Standalone and PC connect
Connectivity options	USB / Wi-Fi (factory installed)
Software compatibility	Brady Workstation Apps, Brady Mobile Apps w/ Wi-Fi model, LabelMark™ (6.0 or higher)
Power supply options	Rechargeable NiMH battery, AC power / battery changer
Standard warranty	2 years
Dimensions	12.93 in. L x 4.22 in. W x 4.19 in. H
Weight	2.46 lbs. (w/o tape, batteries)
Print features	
Screen size	Touchscreen, LCD, Color, 2.8 in. QVGA
Backlit screen	Yes
Keyboard style	QWERTY
Max print width	1.92 in.
Font types available	(2) Brady Alpine and Brady Fixed Width
Font sizes (pts)	4 through 174, autosizing
Multi-line label capabilities	25
Label print rotation	Yes
Data serialization	Yes, multiple and linked
Barcode capabilities	Code 39, Code 128 and more using Brady Workstation
Memory capacity	512 MB RAM / 256 MB Flash
Data transfer from PC	Yes
Print preview	Yes
Symbols available	450
Label supplies	
Label / ribbon supply	Separate label roll and ribbon cartridges
Material formats supported	Continuous, die-cut labels and custom
Media width	0.235 to 2.00 in.
Types of materials	General purpose industrial vinyl, heat-shrink wire ID, self-laminating wire ID, removable cloth wire ID, datacomm cable tags, standard polyester, aggressive adhesive polyester, metallized polyester, non-adhesive tag, polyimide / electronics materials, tamper resistant materials, raised panel labels (engraved plate alternative)
Quantity of label parts available	600+ label parts and customs
Cartridge series	BPTL, BPTDS, BPSPT, BPTLTB, PTL, PSHT, PTLEP, PTS, PTLFP, PSPT, PTPSL, PSFR, PTPS, PTLSL, BM71, BM61, M61, M61C, custom available

Performance that matches your own



Wire and cable marking



PermaSleeve® wire markers



Asset and equipment ID



Patch panel and terminal block ID



Circuit board ID



Facility and safety ID and many more



Brady Workstation Software

Desktop software for your Brady Printer

Brady Workstation has revolutionized how you design and print labels from your PC. When paired with the high-performance printing capabilities of a Brady printer, you get intuitive label set up for simple, efficient and flexible label creation.

- Suites designed with you in mind, contain apps for common safety and facility label designs, product and wire label creation, printing workflows and more
- Displays real-time information about the material installed for easy label set up
- Apps feature built-in regulations, standards, pictograms, common phrases, data importation guidance, help functions and more

▶ Learn more on page 176 or download a free trial at Workstation.BradylD.com



Brady mobile apps for on-the-go printing

We understand that you don't always have your PC with you to design labels. That's why we also offer two Brady Workstation Mobile Apps to enable you to quickly design labels on any iOS device, Android smartphone or Windows tablet and print those labels with your BMP®61 printer (Wi-Fi model required).



• Brady Workstation Mobile Text Labels

Enables you to design professional text-only labels on the spot with your mobile device.



• Brady Workstation Mobile Print Partner

Enables you to complete pre-defined fields with your mobile device using protected company label templates. Simply create your template on your computer and then open the template on your mobile device within the Brady Workstation Mobile Print Partner app from either a local disk (SD-card) or a cloud location, like Google Drive.



TLS2200® and TLS-PC Link™ Owners:

The TLS2200 and TLS-PC Link printers have been discontinued but Brady continues to manufacture and stock label materials, ribbons and accessories for the TLS2200 printer.

1 label roll design = 3 printers*

Most TLS2200 label rolls are also compatible in the BMP61 and BMP71* label printers.

View all label rolls and compatibility on the following pages.

* Compatibility with BMP71 requires use of the black M71-media adapter and firmware 1.13 or higher. View page 154 for more information.

** Each printer requires its own printer-specific ribbon.



Your TLS2200 Printing Solution:

TLS2200 label rolls page 130
 TLS2200 ribbons page 150

BradyPrinter M611 / BMP®61 Materials

BradyID.com/s36

Wire and Cable Materials

Self-Laminating Vinyl Wire and Cable Labels (B-427)

Labels feature a clear, non-printable area that wraps around print-on area to protect text. Vinyl material offers superior resistance to abrasion, solvents, oil, grease, dirt and water. Temp. range -40° F to 158° F (-40° C to 70° C), UL recognized.

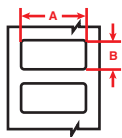

Figure 2

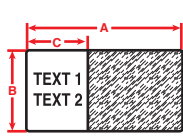

Figure 27

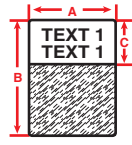

Figure 32

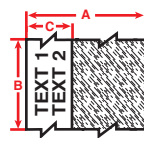

Figure 42b

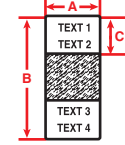

Figure 43



Portable Printers

M611 / BMP61

Fits Printers	Figure	Catalog #	B#	Material	Color	Approx. Wire Gauge	Label Width A Inch (mm)	Label Height B Inch (mm)	Printable Area C Inch (mm)	Labels Per Roll	Rec. Ribbon (M611 / BMP61)
M611, BMP61, 71*, TLS	Fig. 2	PTL-105-427-AW	B-427	Vinyl	White	All White	1.100 (27.9)	0.250 (6.4)	1.100 (27.9)	750	M61-R4310
M611, BMP61, 71*, TLS	Fig. 27	PTL-74-427	B-427	Vinyl	White	Cables	2.200 (55.88)	0.500 (12.7)	0.500 (12.7)	100	M61-R4310
M611, BMP61, 71*, TLS	Fig. 32	PTL-10-427	B-427	Vinyl	White	16 to 10	0.250 (6.35)	0.750 (19.1)	0.250 (6.35)	750	M61-R4310
M611, BMP61, 71*, TLS	Fig. 32	PTL-11-427	B-427	Vinyl	White	16 to 10	0.500 (12.7)	0.750 (19.1)	0.500 (12.7)	500	M61-R4310
M611, BMP61, 71*, TLS	Fig. 32	PTL-96-427	B-427	Vinyl	White	16 to 10	1.000 (25.4)	0.750 (19.1)	1.000 (25.4)	250	M61-R4310
M611, BMP61, 71*, TLS	Fig. 2	PTL-30-427-AW	B-427	Vinyl	White	All White	1.500 (38.1)	0.750 (19.1)	1.500 (38.1)	250	M61-R4310
M611, BMP61, 71*, TLS	Fig. 32	PTL-17-427	B-427	Vinyl	White	12 to 10	0.500 (12.7)	1.000 (25.4)	0.500 (12.7)	500	M61-R4310
M611, BMP61, 71*, TLS	Fig. 32	PTL-18-427	B-427	Vinyl	White	10 to 4	0.750 (19.05)	1.000 (25.4)	0.750 (19.1)	250	M61-R4310
M611, BMP61, 71*, TLS	Fig. 32	PTL-19-427	B-427	Vinyl	White	12 to 10	1.000 (25.4)	1.000 (25.4)	1.000 (25.4)	250	M61-R4310
M611, BMP61, 71*, TLS	Fig. 32	PTL-104-427	B-427	Vinyl	White	12 to 10	1.500 (38.1)	1.000 (25.4)	1.500 (38.1)	250	M61-R4310
M611, BMP61, 71*, TLS	Fig. 32	PTL-87-427	B-427	Vinyl	White	12 to 10	1.750 (44.45)	1.000 (25.4)	1.750 (44.5)	250	M61-R4310
M611, BMP61, 71*, TLS	Fig. 32	PTL-78-427-AW	B-427	Vinyl	White	All White	1.900 (48.26)	1.000 (25.4)	1.900 (48.2)	250	M61-R4310
M611, BMP61, 71*, TLS	Fig. 32	PTL-102-427	B-427	Vinyl	White	10 to 4	0.500 (12.7)	1.250 (31.8)	0.500 (12.7)	250	M61-R4310
M611, BMP61, 71*, TLS	Fig. 32	PTL-103-427	B-427	Vinyl	White	10 to 4	1.000 (25.4)	1.250 (31.8)	1.000 (25.4)	250	M61-R4310
M611, BMP61, 71*, TLS	Fig. 32	PTL-28-427	B-427	Vinyl	White	10 to 4	0.250 (6.35)	1.500 (38.1)	0.250 (6.35)	750	M61-R4310
M611, BMP61, 71*, TLS	Fig. 32	PTL-29-427	B-427	Vinyl	White	10 to 4	0.500 (12.7)	1.500 (38.1)	0.500 (12.7)	500	M61-R4310
M611, BMP61, 71*, TLS	Fig. 32	PTL-30-427	B-427	Vinyl	White	10 to 4	0.750 (19.05)	1.500 (38.1)	0.750 (19.1)	250	M61-R4310
M611, BMP61, 71*, TLS	Fig. 32	PTL-31-427	B-427	Vinyl	White	10 to 4	1.000 (25.4)	1.500 (38.1)	1.000 (25.4)	250	M61-R4310
M611, BMP61, 71*, TLS	Fig. 32	PTL-32-427	B-427	Vinyl	White	10 to 4	1.500 (38.1)	1.500 (38.1)	1.500 (38.1)	250	M61-R4310
M611, BMP61, 71*, TLS	Fig. 32	PTL-88-427	B-427	Vinyl	White	10 to 4	1.750 (44.45)	1.500 (38.1)	1.750 (44.5)	250	M61-R4310
M611, BMP61, 71*, TLS	Fig. 32	PTL-107-427	B-427	Vinyl	White	10 to 4	2.000 (50.8)	1.500 (38.1)	2.000 (50.8)	100	M61-R4310
M611, BMP61, 71*, TLS	Fig. 32	PTL-21-427	B-427	Vinyl	White	Cables	1.000 (25.4)	2.500 (63.5)	1.000 (25.4)	100	M61-R4310
M611, BMP61, 71*, TLS	Fig. 32	PTL-157-427	B-427	Vinyl	White	Cables	1.500 (38.1)	2.500 (63.5)	1.500 (38.1)	100	M61-R4310
M611, BMP61, 71*, TLS	Fig. 32	PTL-75-427	B-427	Vinyl	White	Cables	1.000 (25.4)	2.625 (66.68)	1.000 (25.4)	100	M61-R4310
M611, BMP61, 71*, TLS	Fig. 32	PTL-66-427	B-427	Vinyl	White	Cables	1.938 (49.23)	3.150 (80)	1.938 (49.2)	100	M61-R4310
M611, BMP61, 71*, TLS	Fig. 43	PTL-64-427	B-427	Vinyl	White	Cables	1.000 (25.4)	3.375 (85.7)	1.000 (25.4)	100	M61-R4310
M611, BMP61, 71*, TLS	Fig. 32	PTL-23-427	B-427	Vinyl	White	Cables	1.000 (25.4)	4.000 (101.6)	1.000 (25.4)	100	M61-R4310
M611, BMP61, 71*, TLS	Fig. 32	PTL-33-427	B-427	Vinyl	White	Cables	1.500 (38.1)	4.000 (101.6)	1.000 (25.4)	100	M61-R4310
M611, BMP61, 71*, TLS	Fig. 32	PTL-109-427	B-427	Vinyl	White	Cables	1.500 (38.1)	4.000 (101.6)	1.500 (38.1)	100	M61-R4310
M611, BMP61, 71*, TLS	Fig. 32	PTL-34-427	B-427	Vinyl	White	Cables	1.500 (38.1)	6.000 (152.4)	1.500 (38.1)	50	M61-R4310
M611, BMP61, 71*, TLS	Fig. 42b	PTL-106-427	B-427	Vinyl	White	-	1.500 (38.1)	50 ft. (15.24 m)	-	1 roll (cont.)	M61-R4310
M611, BMP61, 71*, TLS	Fig. 32	PTL-10-427-YL	B-427	Vinyl	Yellow	16 to 10	0.250 (6.35)	0.750 (19.1)	0.250 (6.35)	750	M61-R4310
M611, BMP61, 71*, TLS	Fig. 32	PTL-11-427-YL	B-427	Vinyl	Yellow	16 to 10	0.500 (12.7)	0.750 (19.1)	0.500 (12.7)	500	M61-R4310
M611, BMP61, 71*, TLS	Fig. 32	PTL-17-427-YL	B-427	Vinyl	Yellow	12 to 10	0.500 (12.7)	1.000 (25.4)	0.500 (12.7)	500	M61-R4310
M611, BMP61, 71*, TLS	Fig. 32	PTL-18-427-YL	B-427	Vinyl	Yellow	10 to 4	0.750 (19.05)	1.000 (25.4)	0.750 (19.1)	250	M61-R4310
M611, BMP61, 71*, TLS	Fig. 32	PTL-19-427-YL	B-427	Vinyl	Yellow	12 to 10	1.000 (25.4)	1.000 (25.4)	1.000 (25.4)	250	M61-R4310
M611, BMP61, 71*, TLS	Fig. 32	PTL-28-427-YL	B-427	Vinyl	Yellow	10 to 4	0.250 (6.35)	1.500 (38.1)	0.250 (6.35)	750	M61-R4310
M611, BMP61, 71*, TLS	Fig. 32	PTL-29-427-YL	B-427	Vinyl	Yellow	10 to 4	0.500 (12.7)	1.500 (38.1)	0.500 (12.7)	500	M61-R4310
M611, BMP61, 71*, TLS	Fig. 32	PTL-30-427-YL	B-427	Vinyl	Yellow	10 to 4	0.750 (19.05)	1.500 (38.1)	0.750 (19.1)	250	M61-R4310
M611, BMP61, 71*, TLS	Fig. 32	PTL-31-427-YL	B-427	Vinyl	Yellow	10 to 4	1.000 (25.4)	1.500 (38.1)	1.000 (25.4)	250	M61-R4310
M611, BMP61, 71*, TLS	Fig. 32	PTL-32-427-YL	B-427	Vinyl	Yellow	10 to 4	1.500 (38.1)	1.500 (38.1)	1.500 (38.1)	250	M61-R4310
M611, BMP61, 71*, TLS	Fig. 32	PTL-21-427-YL	B-427	Vinyl	Yellow	Cables	1.000 (25.4)	2.500 (63.5)	1.000 (25.4)	100	M61-R4310
M611, BMP61, 71*, TLS	Fig. 32	PTL-23-427-YL	B-427	Vinyl	Yellow	Cables	1.000 (25.4)	4.000 (101.6)	1.000 (25.4)	100	M61-R4310
M611, BMP61, 71*, TLS	Fig. 32	PTL-33-427-YL	B-427	Vinyl	Yellow	Cables	1.500 (38.1)	4.000 (101.6)	1.000 (25.4)	100	M61-R4310
M611, BMP61, 71*, TLS	Fig. 32	PTL-34-427-YL	B-427	Vinyl	Yellow	Cables	1.500 (38.1)	6.000 (152.4)	1.500 (38.1)	50	M61-R4310

Self-Laminating Labels continue on next page.

Wire and Cable Materials

Self-Laminating Vinyl Wire and Cable Labels (continued)

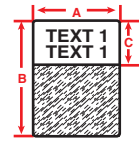

Figure 32

Fits Printers	Figure	Catalog #	B#	Material	Color	Approx. Wire Gauge	Label Width A Inch (mm)	Label Height B Inch (mm)	Printable Area C Inch (mm)	Labels Per Roll	Rec. Ribbon (M611 / BMP61)
M611, BMP61, 71*, TLS	Fig. 32	PTL-19-427-RD	B-427	Vinyl	Red	12 to 10	1.000 (25.4)	1.000 (25.4)	1.000 (25.4)	250	M61-R4310
M611, BMP61, 71*, TLS	Fig. 32	PTL-28-427-RD	B-427	Vinyl	Red	10 to 4	0.250 (6.35)	1.500 (38.1)	0.250 (6.35)	750	M61-R4310
M611, BMP61, 71*, TLS	Fig. 32	PTL-29-427-RD	B-427	Vinyl	Red	10 to 4	0.500 (12.7)	1.500 (38.1)	0.500 (12.7)	500	M61-R4310
M611, BMP61, 71*, TLS	Fig. 32	PTL-30-427-RD	B-427	Vinyl	Red	10 to 4	0.750 (19.05)	1.500 (38.1)	0.750 (19.1)	250	M61-R4310
M611, BMP61, 71*, TLS	Fig. 32	PTL-31-427-RD	B-427	Vinyl	Red	10 to 4	1.000 (25.4)	1.500 (38.1)	1.000 (25.4)	250	M61-R4310
M611, BMP61, 71*, TLS	Fig. 32	PTL-32-427-RD	B-427	Vinyl	Red	10 to 4	1.500 (38.1)	1.500 (38.1)	1.500 (38.1)	250	M61-R4310
M611, BMP61, 71*, TLS	Fig. 32	PTL-21-427-RD	B-427	Vinyl	Red	Cables	1.000 (25.4)	2.500 (63.5)	1.000 (25.4)	100	M61-R4310
M611, BMP61, 71*, TLS	Fig. 32	PTL-23-427-RD	B-427	Vinyl	Red	Cables	1.000 (25.4)	4.000 (101.6)	1.000 (25.4)	100	M61-R4310
M611, BMP61, 71*, TLS	Fig. 32	PTL-33-427-RD	B-427	Vinyl	Red	Cables	1.500 (38.1)	4.000 (101.6)	1.000 (25.4)	100	M61-R4310
M611, BMP61, 71*, TLS	Fig. 32	PTL-34-427-RD	B-427	Vinyl	Red	Cables	1.500 (38.1)	6.000 (152.4)	1.500 (38.1)	50	M61-R4310
M611, BMP61, 71*, TLS	Fig. 32	PTL-19-427-GR	B-427	Vinyl	Green	12 to 10	1.000 (25.4)	1.000 (25.4)	1.000 (25.4)	250	M61-R4310
M611, BMP61, 71*, TLS	Fig. 32	PTL-28-427-GR	B-427	Vinyl	Green	10 to 4	0.250 (6.35)	1.500 (38.1)	0.250 (6.35)	750	M61-R4310
M611, BMP61, 71*, TLS	Fig. 32	PTL-29-427-GR	B-427	Vinyl	Green	10 to 4	0.500 (12.7)	1.500 (38.1)	0.500 (12.7)	500	M61-R4310
M611, BMP61, 71*, TLS	Fig. 32	PTL-30-427-GR	B-427	Vinyl	Green	10 to 4	0.750 (19.05)	1.500 (38.1)	0.750 (19.1)	250	M61-R4310
M611, BMP61, 71*, TLS	Fig. 32	PTL-31-427-GR	B-427	Vinyl	Green	10 to 4	1.000 (25.4)	1.500 (38.1)	1.000 (25.4)	250	M61-R4310
M611, BMP61, 71*, TLS	Fig. 32	PTL-32-427-GR	B-427	Vinyl	Green	10 to 4	1.500 (38.1)	1.500 (38.1)	1.500 (38.1)	250	M61-R4310
M611, BMP61, 71*, TLS	Fig. 32	PTL-21-427-GR	B-427	Vinyl	Green	Cables	1.000 (25.4)	2.500 (63.5)	1.000 (25.4)	100	M61-R4310
M611, BMP61, 71*, TLS	Fig. 32	PTL-23-427-GR	B-427	Vinyl	Green	Cables	1.000 (25.4)	4.000 (101.6)	1.000 (25.4)	100	M61-R4310
M611, BMP61, 71*, TLS	Fig. 32	PTL-33-427-GR	B-427	Vinyl	Green	Cables	1.500 (38.1)	4.000 (101.6)	1.000 (25.4)	100	M61-R4310
M611, BMP61, 71*, TLS	Fig. 32	PTL-34-427-GR	B-427	Vinyl	Green	Cables	1.500 (38.1)	6.000 (152.4)	1.500 (38.1)	50	M61-R4310
M611, BMP61, 71*, TLS	Fig. 32	PTL-19-427-OR	B-427	Vinyl	Orange	10 to 4	1.500 (38.1)	0.750 (19.1)	0.750 (19.1)	250	M61-R4310
M611, BMP61, 71*, TLS	Fig. 32	PTL-19-427-OR	B-427	Vinyl	Orange	12 to 10	1.000 (25.4)	1.000 (25.4)	1.000 (25.4)	250	M61-R4310
M611, BMP61, 71*, TLS	Fig. 32	PTL-28-427-OR	B-427	Vinyl	Orange	10 to 4	0.250 (6.35)	1.500 (38.1)	0.250 (6.35)	750	M61-R4310
M611, BMP61, 71*, TLS	Fig. 32	PTL-29-427-OR	B-427	Vinyl	Orange	10 to 4	0.500 (12.7)	1.500 (38.1)	0.500 (12.7)	500	M61-R4310
M611, BMP61, 71*, TLS	Fig. 32	PTL-31-427-OR	B-427	Vinyl	Orange	10 to 4	1.000 (25.4)	1.500 (38.1)	1.000 (25.4)	250	M61-R4310
M611, BMP61, 71*, TLS	Fig. 32	PTL-32-427-OR	B-427	Vinyl	Orange	10 to 4	1.500 (38.1)	1.500 (38.1)	1.500 (38.1)	250	M61-R4310
M611, BMP61, 71*, TLS	Fig. 32	PTL-21-427-OR	B-427	Vinyl	Orange	Cables	1.000 (25.4)	2.500 (63.5)	1.000 (25.4)	100	M61-R4310
M611, BMP61, 71*, TLS	Fig. 32	PTL-23-427-OR	B-427	Vinyl	Orange	Cables	1.000 (25.4)	4.000 (101.6)	1.000 (25.4)	100	M61-R4310
M611, BMP61, 71*, TLS	Fig. 32	PTL-33-427-OR	B-427	Vinyl	Orange	Cables	1.500 (38.1)	4.000 (101.6)	1.000 (25.4)	100	M61-R4310
M611, BMP61, 71*, TLS	Fig. 32	PTL-34-427-OR	B-427	Vinyl	Orange	Cables	1.500 (38.1)	6.000 (152.4)	1.500 (38.1)	50	M61-R4310

Self-Laminating Labels continue on next page.

Self-Laminating Label Heights

If you know your wire diameter or wire circumference, you can easily determine the correct label height by using the formula below:

Step 1:
$$\frac{\text{wire dia.}}{\times 3.147 (\pi)} = \text{wire circumference}$$

Step 2:
$$\frac{\text{wire circumference}}{\times 1.5} = \text{total label height needed}$$

(Multiplying by 1.5 allows the label to wrap around the wire 1.5 times)



BradyPrinter M611 / BMP®61 Materials

BradyID.com/s36

Wire and Cable Materials

Self-Laminating Vinyl Wire and Cable Labels (continued)

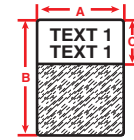

Figure 32

Fits Printers	Figure	Catalog #	B#	Material	Color	Approx. Wire Gauge	Label Width A Inch (mm)	Label Height B Inch (mm)	Printable Area C Inch (mm)	Labels Per Roll	Rec. Ribbon (M611 / BMP61)
M611, BMP61, 71*, TLS	Fig. 32	PTL-19-427-BL	B-427	Vinyl	Blue	12 to 10	1.000 (25.4)	1.000 (25.4)	1.000 (25.4)	250	M61-R4310
M611, BMP61, 71*, TLS	Fig. 32	PTL-28-427-BL	B-427	Vinyl	Blue	10 to 4	0.250 (6.35)	1.500 (38.1)	0.250 (6.35)	750	M61-R4310
M611, BMP61, 71*, TLS	Fig. 32	PTL-29-427-BL	B-427	Vinyl	Blue	10 to 4	0.500 (12.7)	1.500 (38.1)	0.500 (12.7)	500	M61-R4310
M611, BMP61, 71*, TLS	Fig. 32	PTL-30-427-BL	B-427	Vinyl	Blue	10 to 4	0.750 (19.05)	1.500 (38.1)	0.750 (19.1)	250	M61-R4310
M611, BMP61, 71*, TLS	Fig. 32	PTL-31-427-BL	B-427	Vinyl	Blue	10 to 4	1.000 (25.4)	1.500 (38.1)	1.000 (25.4)	250	M61-R4310
M611, BMP61, 71*, TLS	Fig. 32	PTL-32-427-BL	B-427	Vinyl	Blue	10 to 4	1.500 (38.1)	1.500 (38.1)	1.500 (38.1)	250	M61-R4310
M611, BMP61, 71*, TLS	Fig. 32	PTL-21-427-BL	B-427	Vinyl	Blue	Cables	1.000 (25.4)	2.500 (63.5)	1.000 (25.4)	100	M61-R4310
M611, BMP61, 71*, TLS	Fig. 32	PTL-23-427-BL	B-427	Vinyl	Blue	Cables	1.000 (25.4)	4.000 (101.6)	1.000 (25.4)	100	M61-R4310
M611, BMP61, 71*, TLS	Fig. 32	PTL-33-427-BL	B-427	Vinyl	Blue	Cables	1.500 (38.1)	4.000 (101.6)	1.000 (25.4)	100	M61-R4310
M611, BMP61, 71*, TLS	Fig. 32	PTL-34-427-BL	B-427	Vinyl	Blue	Cables	1.500 (38.1)	6.000 (152.4)	1.500 (38.1)	50	M61-R4310
M611, BMP61, 71*, TLS	Fig. 32	PTL-19-427-PL	B-427	Vinyl	Purple	12 to 10	1.000 (25.4)	1.000 (25.4)	1.000 (25.4)	250	M61-R4310
M611, BMP61, 71*, TLS	Fig. 32	PTL-28-427-PL	B-427	Vinyl	Purple	10 to 4	0.250 (6.35)	1.500 (38.1)	0.250 (6.35)	750	M61-R4310
M611, BMP61, 71*, TLS	Fig. 32	PTL-29-427-PL	B-427	Vinyl	Purple	10 to 4	0.500 (12.7)	1.500 (38.1)	0.500 (12.7)	500	M61-R4310
M611, BMP61, 71*, TLS	Fig. 32	PTL-30-427-PL	B-427	Vinyl	Purple	10 to 4	0.750 (19.05)	1.500 (38.1)	0.750 (19.1)	250	M61-R4310
M611, BMP61, 71*, TLS	Fig. 32	PTL-31-427-PL	B-427	Vinyl	Purple	10 to 4	1.000 (25.4)	1.500 (38.1)	1.000 (25.4)	250	M61-R4310
M611, BMP61, 71*, TLS	Fig. 32	PTL-32-427-PL	B-427	Vinyl	Purple	10 to 4	1.500 (38.1)	1.500 (38.1)	1.500 (38.1)	250	M61-R4310
M611, BMP61, 71*, TLS	Fig. 32	PTL-21-427-PL	B-427	Vinyl	Purple	Cables	1.000 (25.4)	2.500 (63.5)	1.000 (25.4)	100	M61-R4310
M611, BMP61, 71*, TLS	Fig. 32	PTL-23-427-PL	B-427	Vinyl	Purple	Cables	1.000 (25.4)	4.000 (101.6)	1.000 (25.4)	100	M61-R4310
M611, BMP61, 71*, TLS	Fig. 32	PTL-33-427-PL	B-427	Vinyl	Purple	Cables	1.500 (38.1)	4.000 (101.6)	1.000 (25.4)	100	M61-R4310
M611, BMP61, 71*, TLS	Fig. 32	PTL-34-427-PL	B-427	Vinyl	Purple	Cables	1.500 (38.1)	6.000 (152.4)	1.500 (38.1)	50	M61-R4310
M611, BMP61, 71*, TLS	Fig. 32	PTL-19-427-BR	B-427	Vinyl	Brown	12 to 10	1.000 (25.4)	1.000 (25.4)	1.000 (25.4)	250	M61-R4310
M611, BMP61, 71*, TLS	Fig. 32	PTL-28-427-BR	B-427	Vinyl	Brown	10 to 4	0.250 (6.35)	1.500 (38.1)	0.250 (6.35)	750	M61-R4310
M611, BMP61, 71*, TLS	Fig. 32	PTL-29-427-BR	B-427	Vinyl	Brown	10 to 4	0.500 (12.7)	1.500 (38.1)	0.500 (12.7)	500	M61-R4310
M611, BMP61, 71*, TLS	Fig. 32	PTL-30-427-BR	B-427	Vinyl	Brown	10 to 4	0.750 (19.05)	1.500 (38.1)	0.750 (19.1)	250	M61-R4310
M611, BMP61, 71*, TLS	Fig. 32	PTL-31-427-BR	B-427	Vinyl	Brown	10 to 4	1.000 (25.4)	1.500 (38.1)	1.000 (25.4)	250	M61-R4310
M611, BMP61, 71*, TLS	Fig. 32	PTL-32-427-BR	B-427	Vinyl	Brown	10 to 4	1.500 (38.1)	1.500 (38.1)	1.500 (38.1)	250	M61-R4310
M611, BMP61, 71*, TLS	Fig. 32	PTL-21-427-BR	B-427	Vinyl	Brown	Cables	1.000 (25.4)	2.500 (63.5)	1.000 (25.4)	100	M61-R4310
M611, BMP61, 71*, TLS	Fig. 32	PTL-23-427-BR	B-427	Vinyl	Brown	Cables	1.000 (25.4)	4.000 (101.6)	1.000 (25.4)	100	M61-R4310
M611, BMP61, 71*, TLS	Fig. 32	PTL-33-427-BR	B-427	Vinyl	Brown	Cables	1.500 (38.1)	4.000 (101.6)	1.000 (25.4)	100	M61-R4310
M611, BMP61, 71*, TLS	Fig. 32	PTL-34-427-BR	B-427	Vinyl	Brown	Cables	1.500 (38.1)	6.000 (152.4)	1.500 (38.1)	50	M61-R4310
M611, BMP61, 71*, TLS	Fig. 32	PTL-19-427-GY	B-427	Vinyl	Gray	12 to 10	1.000 (25.4)	1.000 (25.4)	1.000 (25.4)	250	M61-R4310
M611, BMP61, 71*, TLS	Fig. 32	PTL-28-427-GY	B-427	Vinyl	Gray	10 to 4	0.250 (6.35)	1.500 (38.1)	0.250 (6.35)	750	M61-R4310
M611, BMP61, 71*, TLS	Fig. 32	PTL-29-427-GY	B-427	Vinyl	Gray	10 to 4	0.500 (12.7)	1.500 (38.1)	0.500 (12.7)	500	M61-R4310
M611, BMP61, 71*, TLS	Fig. 32	PTL-30-427-GY	B-427	Vinyl	Gray	10 to 4	0.750 (19.05)	1.500 (38.1)	0.750 (19.1)	250	M61-R4310
M611, BMP61, 71*, TLS	Fig. 32	PTL-31-427-GY	B-427	Vinyl	Gray	10 to 4	1.000 (25.4)	1.500 (38.1)	1.000 (25.4)	250	M61-R4310
M611, BMP61, 71*, TLS	Fig. 32	PTL-32-427-GY	B-427	Vinyl	Gray	10 to 4	1.500 (38.1)	1.500 (38.1)	1.500 (38.1)	250	M61-R4310
M611, BMP61, 71*, TLS	Fig. 32	PTL-21-427-GY	B-427	Vinyl	Gray	Cables	1.000 (25.4)	2.500 (63.5)	1.000 (25.4)	100	M61-R4310
M611, BMP61, 71*, TLS	Fig. 32	PTL-23-427-GY	B-427	Vinyl	Gray	Cables	1.000 (25.4)	4.000 (101.6)	1.000 (25.4)	100	M61-R4310
M611, BMP61, 71*, TLS	Fig. 32	PTL-33-427-GY	B-427	Vinyl	Gray	Cables	1.500 (38.1)	4.000 (101.6)	1.000 (25.4)	100	M61-R4310
M611, BMP61, 71*, TLS	Fig. 32	PTL-34-427-GY	B-427	Vinyl	Gray	Cables	1.500 (38.1)	6.000 (152.4)	1.500 (38.1)	50	M61-R4310

Self-Extinguishing Polyvinylfluoride Labels (B-642)

Clear Polyvinylfluoride film with a white printable zone and a translucent overlaminating area offers excellent flexibility for wrapping around small diameter wires. Material features self-extinguishing properties and is solvent resistant.

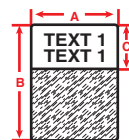

Figure 32



Fits Printers	Figure	Catalog #	B#	Material	Color	Label Width A Inch (mm)	Label Height B Inch (mm)	Printer Area C Inch (mm)	Labels Per Roll	Rec. Ribbon (M611 / BMP61)
M611, BMP61, 71*, TLS	Fig. 32	PTL-19-642	B-642	Polyvinylfluoride	White	1.000 (25.4)	1.000 (25.4)	0.375 (9.5)	250	M61-R4310
M611, BMP61, 71*, TLS	Fig. 32	PTL-31-642	B-642	Polyvinylfluoride	White	1.000 (25.4)	1.500 (38.1)	0.500 (12.7)	250	M61-R4310
M611, BMP61, 71*, TLS	Fig. 32	PTL-21-642	B-642	Polyvinylfluoride	White	1.000 (25.4)	2.500 (63.5)	0.750 (19.1)	100	M61-R4310

Portable Printers

M611 / BMP61

Wire and Cable Materials

Vinyl and Nylon Cloth Wire and Cable Labels (B-498 and B-499)

- **B-498 Repositionable Vinyl Cloth:** Adhesive and cloth backing offers excellent holding power, yet allow for clean removal and repositioning if necessary. Temp. range: -40° F to 175° F (-40° C to 70° C). UL recognized
- **B-499 Nylon Cloth Material:** Permanent adhesive. Pliable for rough or smooth surfaces. Temp. range: -94° F to 194° F (-70° C to 90° C). UL recognized

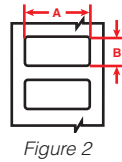

Fits Printers	Figure	Catalog #	B#	Material	Color	Approx. Wire Gauge	Label Width A Inch (mm)	Label Height B Inch (mm)	Labels Per Roll	Rec. Ribbon (M611 / BMP61)
B-498 Repositionable Vinyl Cloth										
M611, BMP61, 71*, TLS	Fig. 2	PTL-7-498	B-498	Vinyl	White	22 to 16	0.500 (12.7)	0.500 (12.7)	500	M61-R4310
M611, BMP61, 71*, TLS	Fig. 2	PTL-15-498	B-498	Vinyl	White	22 to 16	1.000 (25.4)	0.275 (7)	750	M61-R4310
M611, BMP61, 71*, TLS	Fig. 2	PTL-10-498	B-498	Vinyl	White	16 to 10	0.250 (6.35)	0.750 (19.1)	750	M61-R4310
M611, BMP61, 71*, TLS	Fig. 2	PTL-11-498	B-498	Vinyl	White	16 to 10	0.500 (12.7)	0.750 (19.1)	500	M61-R4310
M611, BMP61, 71*, TLS	Fig. 2	PTL-16-498	B-498	Vinyl	White	12 to 10	0.375 (9.53)	1.000 (25.4)	500	M61-R4310
M611, BMP61, 71*, TLS	Fig. 2	PTL-17-498	B-498	Vinyl	White	12 to 10	1.000 (25.4)	0.500 (12.7)	500	M61-R4310
M611, BMP61, 71*, TLS	Fig. 2	PTL-19-498	B-498	Vinyl	White	12 to 10	1.000 (25.4)	1.000 (25.4)	250	M61-R4310
M611, BMP61, 71*, TLS	Fig. 2	PTL-18-498	B-498	Vinyl	White	10 to 4	0.750 (19.05)	1.000 (25.4)	250	M61-R4310
M611, BMP61, 71*, TLS	Fig. 2	PTL-30-498	B-498	Vinyl	White	10 to 4	0.750 (19.05)	1.500 (38.1)	250	M61-R4310
M611, BMP61, 71*, TLS	Fig. 2	PTL-31-498	B-498	Vinyl	White	10 to 4	1.500 (38.1)	1.000 (25.4)	250	M61-R4310
M611, BMP61, 71*, TLS	Fig. 2	PTL-28-498	B-498	Vinyl	White	10 to 4	1.500 (38.1)	0.250 (6.4)	750	M61-R4310
M611, BMP61, 71*, TLS	Fig. 2	PTL-29-498	B-498	Vinyl	White	10 to 4	1.500 (38.1)	0.500 (12.7)	500	M61-R4310
M611, BMP61, 71*, TLS	Fig. 2	PTL-32-498	B-498	Vinyl	White	10 to 4	1.500 (38.1)	1.500 (38.1)	250	M61-R4310
M611, BMP61, 71*, TLS	Fig. 2	PTL-21-498	B-498	Vinyl	White	-	1.000 (25.4)	2.500 (63.5)	100	M61-R4310
M611, BMP61, 71*, TLS	Fig. 2	PTL-23-498	B-498	Vinyl	White	-	1.000 (25.4)	4.000 (101.6)	100	M61-R4310
M611, BMP61, 71*, TLS	Fig. 2	PTL-33-498	B-498	Vinyl	White	-	1.500 (38.1)	4.000 (101.6)	100	M61-R4310
M611, BMP61, 71*, TLS	Fig. 2	PTL-34-498	B-498	Vinyl	White	-	1.500 (38.1)	6.000 (152.4)	50	M61-R4310
B-499 Nylon Cloth										
M611, BMP61, 71*, TLS	Fig. 2	PTL-7-499	B-499	Vinyl	White	22 to 16	0.500 (12.7)	0.500 (12.7)	500	M61-R4310
M611, BMP61, 71*, TLS	Fig. 2	PTL-11-499	B-499	Vinyl	White	16 to 10	0.500 (12.7)	0.750 (19.1)	500	M61-R4310
M611, BMP61, 71*, TLS	Fig. 2	PTL-16-499	B-499	Vinyl	White	12 to 10	0.375 (9.53)	1.000 (25.4)	500	M61-R4310
M611, BMP61, 71*, TLS	Fig. 2	PTL-19-499	B-499	Vinyl	White	12 to 10	1.000 (25.4)	1.000 (25.4)	250	M61-R4310
M611, BMP61, 71*, TLS	Fig. 2	PTL-29-499	B-499	Vinyl	White	10 to 4	0.500 (12.7)	1.500 (38.1)	500	M61-R4310
M611, BMP61, 71*, TLS	Fig. 2	PTL-18-499	B-499	Vinyl	White	10 to 4	0.750 (19.05)	1.000 (25.4)	250	M61-R4310
M611, BMP61, 71*, TLS	Fig. 2	PTL-30-499	B-499	Vinyl	White	10 to 4	0.750 (19.05)	1.500 (38.1)	250	M61-R4310
M611, BMP61, 71*, TLS	Fig. 2	PTL-31-499	B-499	Vinyl	White	10 to 4	1.000 (25.4)	1.500 (38.1)	250	M61-R4310
M611, BMP61, 71*, TLS	Fig. 2	PTL-28-499	B-499	Vinyl	White	10 to 4	1.500 (38.1)	0.250 (6.4)	750	M61-R4310
M611, BMP61, 71*, TLS	Fig. 2	PTL-117-499	B-499	Vinyl	White	-	0.900 (22.86)	0.500 (12.7)	500	M61-R4310
M611, BMP61, 71*, TLS	Fig. 2	PTL-84-499	B-499	Vinyl	White	-	0.900 (22.86)	0.500 (12.7)	500	M61-R4310
M611, BMP61, 71*, TLS	Fig. 2	PTL-98-499	B-499	Vinyl	White	-	1.000 (25.4)	0.375 (9.5)	500	M61-R4310
M611, BMP61, 71*, TLS	Fig. 2	PTL-21-499	B-499	Vinyl	White	-	1.000 (25.4)	2.500 (63.5)	100	M61-R4310
M611, BMP61, 71*, TLS	Fig. 2	PTL-23-499	B-499	Vinyl	White	-	1.000 (25.4)	4.000 (101.6)	100	M61-R4310
M611, BMP61, 71*, TLS	Fig. 2	PTL-81-499	B-499	Vinyl	White	-	1.900 (48.26)	0.250 (6.4)	750	M61-R4310
M611, BMP61, 71*, TLS	Fig. 2	PTL-78-499	B-499	Vinyl	White	-	1.900 (48.26)	1.000 (25.4)	250	M61-R4310

High-Temperature Wire and Cable Labels (B-437)

Polyvinylfluoride material for applications where high temperature and self-extinguishing features are required. Heavy-duty performance with excellent resistance to water, oil and other fluids. Meets MIL-M-87958 Standard. Temp. range: -94° F to 275° F (-70° C to 135° C). ROHS compliant.

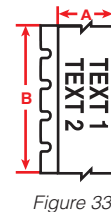
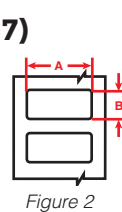

Fits Printers	Figure	Catalog #	B#	Material	Color	Label Width A Inch (mm)	Label Height B Inch (mm)	Labels Per Roll	Rec. Ribbon (M611 / BMP61)
M611, BMP61, 71*, TLS	Fig. 2	PTL-9-437	B-437	Polyvinylfluoride	White	0.650 (16.51)	0.200 (5.1)	750	M61-R4310
M611, BMP61, 71*, TLS	Fig. 2	PTL-10-437	B-437	Polyvinylfluoride	White	0.750 (19.05)	0.250 (6.4)	750	M61-R4310
M611, BMP61, 71*, TLS	Fig. 2	PTL-15-437	B-437	Polyvinylfluoride	White	1.000 (25.4)	0.275 (7)	750	M61-R4310
M611, BMP61, 71*, TLS	Fig. 2	PTL-29-437	B-437	Polyvinylfluoride	White	1.500 (38.1)	0.500 (12.7)	500	M61-R4310
M611, BMP61, 71*, TLS	Fig. 33	PTL-41-437-WT	B-437	Polyvinylfluoride	White	1.500 (38.1)	50 ft. (15.24 m)	1 roll (cont.)	M61-R4310
M611, BMP61, 71*, TLS	Fig. 33	PTL-41-437-YL	B-437	Polyvinylfluoride	Yellow	1.500 (38.1)	50 ft. (15.24 m)	1 roll (cont.)	M61-R4310

BradyPrinter M611 / BMP®61 Materials

BradyID.com/s36

Wire and Cable Materials

Polypropylene Flags (B-425 and B-8425)

- **B-425 Polypropylene Solvent-Resistant Material:** Matte white polypropylene with excellent solvent resistance and print performance; not recommended for long-term outdoor use
- **B-8425 Polypropylene Solvent-Resistant Material:** Glossy white polypropylene with excellent solvent resistance and print performance; not recommended for long-term outdoor use

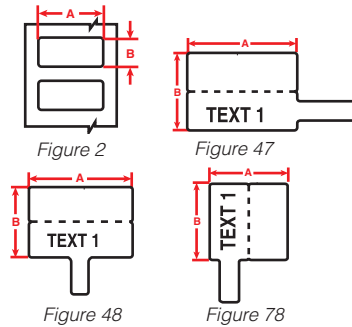

Fits Printers	Figure	Catalog #	B#	Material	Color	Label Width A Inch (mm)	Label Height B Inch (mm)	Labels Per Roll	Rec. Ribbon (M611 / BMP61)
B-425 Permanent Polypropylene									
M611, BMP61, 71*, TLS	Fig. 48	PTLFT-01-425	B-425	Polypropylene	White	1.180 (29.97)	0.788 (20)	250	M61-R6210
M611, BMP61, 71*, TLS	Fig. 47	PTLFP-01-425	B-425	Polypropylene	White	1.180 (29.97)	0.788 (20)	250	M61-R6210
M611, BMP61, 71*, TLS	Fig. 78	PTLFT-54-425	B-425	Polypropylene	White	1.490 (37.85)	1.575 (40)	100	M61-R6210
M611, BMP61, 71*, TLS	Fig. 78	PTLFP-02-425	B-425	Polypropylene	White	1.750 (44.45)	1.000 (25.4)	100	M61-R6210
B-8425 Permanent Polypropylene									
M611, BMP61, 71*, TLS	Fig. 2	PTL-10-8425	B-8425	Polypropylene	White	0.750 (19.05)	0.250 (6.4)	750	M61-R6010
M611, BMP61, 71*, TLS	Fig. 47	PTLFP-01-8425	B-8425	Polypropylene	White	1.180 (29.97)	0.788 (20)	250	M61-R6010
M611, BMP61, 71*, TLS	Fig. 48	PTLFT-01-8425	B-8425	Polypropylene	White	1.180 (29.97)	0.788 (20)	250	M61-R6010

Non-Adhesive Polypropylene Tags (B-109 and B-412)

- **B-109 Non-Adhesive Polyethylene Tags:** Multi-purpose tags for identifying multi-conductor cables. Good weatherability and legibility after solvent exposure
- **B-412 Non-Adhesive Polypropylene Tags:** Thick polypropylene material for hardware identification. High print legibility and high tensile strength

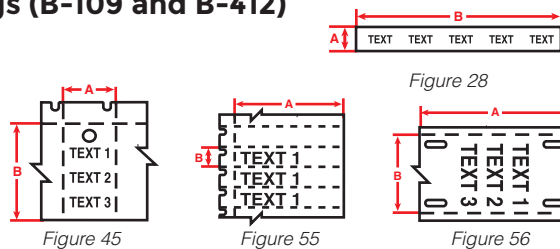

Fits Printers	Figure	Catalog #	B#	Material	Color	Label Width A Inch (mm)	Label Height B Inch (mm)	Labels Per Roll	Rec. Ribbon (M611 / BMP61)
B-109 Non-Adhesive Polyethylene Tag									
M611, BMP61, 71*, TLS	Fig. 56	PTL-12-109	B-109	Polyethylene	White	0.750 (19.05)	3.000 (101.6)	100	M61-R4310
M611, BMP61, 71*, TLS	Fig. 45	PTL-36-109	B-109	Polyethylene	White	1.750 (44.45)	1.125 (28.6)	250	M61-R4310
B-412 Non-Adhesive Polypropylene Tag									
M611, BMP61, 71*, TLS	Fig. 28	PTL-55-412	B-412	Polypropylene	White	0.230 (5.84)	50 ft. (15.24 m)	1 roll (cont.)	M61-R4310
M611, BMP61, 71*, TLS	Fig. 28	PTL-56-412	B-412	Polypropylene	White	0.375 (9.53)	50 ft. (15.24 m)	1 roll (cont.)	M61-R4310
M611, BMP61, 71*, TLS	Fig. 28	PTL-57-412	B-412	Polypropylene	White	0.500 (12.7)	50 ft. (15.24 m)	1 roll (cont.)	M61-R4310
M611, BMP61, 71*, TLS	Fig. 28	PTL-58-412	B-412	Polypropylene	White	0.535 (13.59)	50 ft. (15.24 m)	1 roll (cont.)	M61-R4310
M611, BMP61, 71*, TLS	Fig. 28	PTL-59-412	B-412	Polypropylene	White	0.785 (19.94)	50 ft. (15.24 m)	1 roll (cont.)	M61-R4310
M611, BMP61, 71*, TLS	Fig. 55	PTL-40-412	B-412	Polypropylene	White	1.938 (49.23)	0.375 (9.5)	750	M61-R4310

Polyethylene Tags (B-145 and B-145FR)

Non-adhesive tag material for identifying multi-conductor cable, equipment, safety warning repair and work-in-progress. B-145FR features fire-retardant properties.

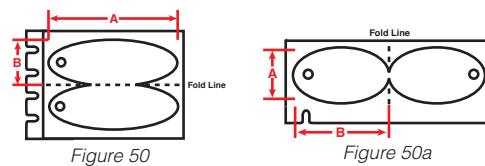

Fits Printers	Figure	Catalog #	B#	Material	Color	Label Width A Inch (mm)	Label Height B Inch (mm)	Labels Per Roll	Rec. Ribbon (M611 / BMP61)
B-145 Polyethylene Tag Material									
M611, BMP61	Fig. 50a	M61-144-145-GY	B-145	Polyethylene	Gray	0.758 (19.3)	1.206 (30.63)	100	M61-R6010
M611, BMP61	Fig. 50a	BM61-144-145-GY	B-145	Polyethylene	Gray	0.758 (19.3)	1.206 (30.63)	900	M61-R6010
M611, BMP61	Fig. 50a	M61-145-145-GY	B-145	Polyethylene	Gray	1.000 (25.4)	1.750 (44.45)	100	M61-R6010
M611, BMP61	Fig. 50a	BM61-145-145-GY	B-145	Polyethylene	Gray	1.000 (25.4)	1.750 (44.45)	650	M61-R6010
B-145FR Flame-Retardant Polyethylene Tag Material									
M611, BMP61	Fig. 50a	M61-144-145FR-GY	B-145FR	Polyethylene	Gray	0.758 (19.3)	1.206 (30.63)	100	M61-R6010
M611, BMP61	Fig. 50a	BM61-144-145FR-GY	B-145FR	Polyethylene	Gray	0.758 (19.3)	1.206 (30.63)	900	M61-R6010
M611, BMP61	Fig. 50a	M61-145-145FR-GY	B-145FR	Polyethylene	Gray	1.000 (25.4)	1.750 (44.45)	100	M61-R6010
M611, BMP61	Fig. 50a	BM61-145-145FR-GY	B-145FR	Polyethylene	Gray	1.000 (25.4)	1.750 (44.45)	650	M61-R6010

The following tags are only compatible with the BMP71 and TLS 2200 printers

BMP71*, TLS ONLY	Fig. 50	PTL-111-145-GY	B-145	Polyethylene	Gray	1.206 (30.63)	0.758 (19.3)	100	R6210 (TLS ribbon)
BMP71*, TLS ONLY	Fig. 50	PTL-110-145-GY	B-145	Polyethylene	Gray	1.750 (44.45)	1.000 (25.4)	100	R6210 (TLS ribbon)
BMP71*, TLS ONLY	Fig. 50	PTL-111-145FR-GY	B-145FR	Polyethylene	Gray	1.206 (30.63)	0.758 (19.3)	100	R6210 (TLS ribbon)
BMP71*, TLS ONLY	Fig. 50	PTL-110-145FR-GY	B-145FR	Polyethylene	Gray	1.750 (44.45)	1.000 (25.4)	100	R6210 (TLS ribbon)

Wire and Cable Materials

Durasleeve® Wire Marking Inserts (B-390)

Matte white polypropylene material is designed to be printed and affixed to a wire using extruded, clear PVC wire-marking carriers (sold separately).

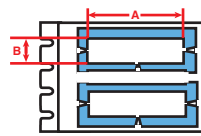
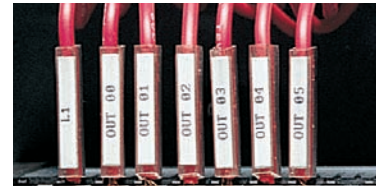

Figure 38



Fits Printers	Figure	Catalog #	B#	Material	Color	Label Width A Inch (mm)	Label Height B Inch (mm)	Labels Per Roll	Rec. Ribbon (M611 / BMP61)
M611, BMP61, 71*, TLS	Fig. 38	BPTDS-15-390	B-390	Polypropylene	White	0.590 (15)	0.163 (4.14)	3000	M61-R6010
M611, BMP61, 71*, TLS	Fig. 38	PTDS-15-390	B-390	Polypropylene	White	0.590 (15)	0.163 (4.14)	300	M61-R6010
M611, BMP61, 71*, TLS	Fig. 38	BPTDS-30-390	B-390	Polypropylene	White	1.181 (30)	0.163 (4.14)	3000	M61-R6010
M611, BMP61, 71*, TLS	Fig. 38	PTDS-30-390	B-390	Polypropylene	White	1.181 (30)	0.163 (4.14)	300	M61-R6010

0.590 in. wide clear carriers

Catalog #	Carrier Width Inch (mm)	Wire Outside Diameter Inch (mm)	Wire Gauge	Qty/ Pkg
DMC-1.3/3-15	0.590 (14.98)	0.051 (1.30) to 0.118 (3.00)	20 to 12	2000
DMC-2.5/5-15	0.590 (14.98)	0.098 (2.50) to 0.197 (5.00)	16 to 10	3000
DMC-4/10-15	0.590 (14.98)	0.157 (4.00) to 0.393 (10.00)	10 to 4	4000
DMC-8/16-15	0.590 (14.98)	0.315 (8.00) to 0.630 (16.00)	6 to 250	7500

1.180 in. wide clear carriers

Catalog #	Carrier Width Inch (mm)	Wire Outside Diameter Inch (mm)	Wire Gauge	Qty/ Pkg
DMC-1.3/3-30	1.180 (29.97)	0.051 (1.30) to 0.118 (3.00)	20 to 12	500
DMC-2.5/5-30	1.180 (29.97)	0.098 (2.50) to 0.197 (5.00)	16 to 10	100
DMC-4/10-30	1.180 (29.97)	0.157 (4.00) to 0.393 (10.00)	10 to 4	200
DMC-8/16-30	1.180 (29.97)	0.315 (8.00) to 0.630 (16.00)	6 to 250	250

BradySleeve™ Wire Markers (B-321)

Heat-shrinkable polyolefin sleeve with excellent resistance to oil and solvents.

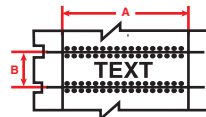

Figure 36



Fits Printers	Figure	Catalog #	B#	Material	Color	Approx. Wire Gauge	Minimum Wire Dia. Inch (mm)	Maximum Wire Dia. Inch (mm)	Diameter as Supplied B Inch (mm)	Sleeve Width A Inch (mm)	Labels Per Roll	Rec. Ribbon (M611 / BMP61)
M611, BMP61, TLS	Fig. 36	PTS-0.45-350-321	B-321	Polyolefin	White	16 to 10	0.075 (1.91)	0.160 (4.06)	0.450 (11.43)	0.350 (8.9)	500	M61-R6210
M611, BMP61, TLS	Fig. 36	PTS-0.95-350-321	B-321	Polyolefin	White	16 to 10	0.075 (1.91)	0.160 (4.06)	0.950 (24.13)	0.350 (8.9)	500	M61-R6210
M611, BMP61, TLS	Fig. 36	PTS-1.90-350-321	B-321	Polyolefin	White	16 to 10	0.075 (1.91)	0.160 (4.06)	1.900 (48.26)	0.350 (8.9)	500	M61-R6210
M611, BMP61, TLS	Fig. 36	PTS-0.45-500-321	B-321	Polyolefin	White	10 to 8	0.160 (4.06)	0.235 (5.97)	0.450 (11.43)	0.500 (12.7)	500	M61-R6210
M611, BMP61, TLS	Fig. 36	PTS-0.95-500-321	B-321	Polyolefin	White	10 to 8	0.160 (4.06)	0.235 (5.97)	0.950 (24.13)	0.500 (12.7)	500	M61-R6210
M611, BMP61, TLS	Fig. 36	PTS-1.90-500-321	B-321	Polyolefin	White	10 to 8	0.160 (4.06)	0.235 (5.97)	1.900 (48.26)	0.500 (12.7)	250	M61-R6210
M611, BMP61, TLS	Fig. 36	PTS-0.95-750-321	B-321	Polyolefin	White	4 to 2	0.335 (8.51)	0.390 (9.91)	0.950 (24.13)	0.750 (19.1)	250	M61-R6210
M611, BMP61, TLS	Fig. 36	PTS-1.90-750-321	B-321	Polyolefin	White	4 to 2	0.335 (8.51)	0.390 (9.91)	1.900 (48.26)	0.750 (19.1)	250	M61-R6210
M611, BMP61, TLS	Fig. 36	PTS-0.95-1000-321	B-321	Polyolefin	White	1 to 0	0.375 (9.53)	0.540 (13.72)	0.950 (24.13)	1.000 (25.4)	250	M61-R6210
M611, BMP61, TLS	Fig. 36	PTS-1.90-1000-321	B-321	Polyolefin	White	1 to 0	0.375 (9.5)	0.540 (13.72)	1.900 (48.26)	1.000 (25.4)	250	M61-R6210

PermaSleeve® FR Fluid-Resistant Wire Markers (B-344)

3:1 heat-shrinkable wire marking sleeves fit snugly around wires for identification and protection and offer greater resistance to harsh chemicals such as fuels, lubricants and cleaning solvents. Temp. range: -67° F to 275° F (-55° C to 135° C).

Meets specifications:

- SAE-AMS-DTL23053/6 (Class 1)
- SAE-AS-81531
- MIL-STD-202G, method 215K

Tested per:

- ASTM E162
- ASTM E662
- MIL-STD-202G

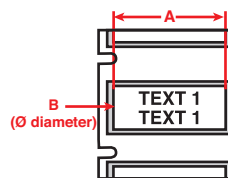

Figure 44



Fits Printers	Figure	Catalog #	Color	Approx. Wire Gauge	Minimum Wire Dia. Inch (mm)	Maximum Wire Dia. Inch (mm)	Diameter as Supplied B Inch (mm)	Recovered Diameter Inch (mm)	Sleeve Width A Inch (mm)	Qty. Per Roll	Rec. Ribbon (M611 / BMP61)
M611, BMP61, 71*, TLS	Fig. 44	** PSFR-187-175-WT	White	18 to 12	0.062 (1.6)	0.150 (3.8)	0.187 (4.8)	0.062 (1.6)	1.750 (44.5)	100	M61-R6610
M611, BMP61, 71*, TLS	Fig. 44	** PSFR-250-1-WT	White	20 to 10	0.083 (2.1)	0.215 (5.5)	0.250 (6.4)	0.083 (2.1)	1.000 (25.4)	100	M61-R6610
M611, BMP61, 71*, TLS	Fig. 44	** PSFR-500-1-WT	White	8 to 1	0.166 (4.2)	0.450 (11.4)	0.500 (12.7)	0.166 (4.2)	1.000 (25.4)	100	M61-R6610
M611, BMP61, 71*, TLS	Fig. 44	** PSFR-250-1-YL	Yellow	20 to 10	0.083 (2.1)	0.215 (5.5)	0.250 (6.4)	0.083 (2.1)	1.000 (25.4)	100	M61-R6610
M611, BMP61, 71*, TLS	Fig. 44	** PSFR-250-175-YL	Yellow	20 to 10	0.083 (2.1)	0.215 (5.5)	0.250 (6.4)	0.083 (2.1)	1.750 (44.5)	100	M61-R6610
M611, BMP61, 71*, TLS	Fig. 44	** PSFR-750-175-BK	Black	8 to 1	0.250 (6.4)	0.700 (17.8)	0.750 (19.1)	0.250 (6.4)	1.750 (44.5)	100	M61-R6710-WT

** ⚠️ **WARNING:** Cancer www.P65Warnings.ca.gov

BradyPrinter M611 / BMP®61 Materials

BradyID.com/s36

Wire and Cable Materials

PermaSleeve® PS Polyolefin Wire Markers (B-342)

Military / industrial grade sleeves offer the ultimate in marker durability, permanence and aesthetic appearance. 3:1 heat-shrinkable markers fit snugly around wires, are fade-resistant and flame-retardant. Temp range: -67° F to 275° F (-55° C to 130° C). RoHS compliant and UL recognized.

Meets specifications:

- SSAE-AS-23053/5
- SAE-AS-81531

Tested per:

- ASTM E162
- ASTM E662
- MIL-STD-202

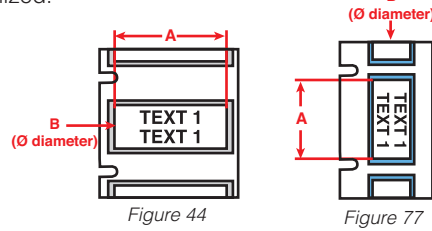

Fits Printers	Figure	Catalog #	Color	Approx. Wire Gauge	Minimum Wire Dia. Inch (mm)	Maximum Wire Dia. Inch (mm)	Diameter as Supplied B Inch (mm)	Recovered Diameter Inch (mm)	Sleeve Width A Inch (mm)	Qty. Per Roll	Rec. Ribbon (M611 / BMP61)
M611, BMP61, 71*, TLS	Fig. 44	** PSPT-094-1-WT	White	28 to 18	0.023 (0.6)	0.080 (2)	0.094 (2.4)	0.023 (0.6)	1.000 (25.4)	100	M61-R6610
M611, BMP61, 71*, TLS	Fig. 44	** PSPT-094-175-WT	White	28 to 18	0.023 (0.6)	0.080 (2)	0.094 (2.4)	0.023 (0.6)	1.750 (44.5)	100	M61-R6610
M611, BMP61, 71*, TLS	Fig. 77	** PSPT-094-2-WT-R	White	28 to 18	0.023 (0.6)	0.080 (2)	0.094 (2.4)	0.023 (0.6)	2.000 (50.8)	70	M61-R6610
M611, BMP61, 71*, TLS	Fig. 44	** PSPT-125-1-WT	White	22 to 16	0.046 (1.2)	0.110 (2.8)	0.125 (3.2)	0.046 (1.2)	1.000 (25.4)	100	M61-R6610
M611, BMP61, 71*, TLS	Fig. 44	** PSPT-125-175-WT	White	22 to 16	0.046 (1.2)	0.110 (2.8)	0.125 (3.2)	0.046 (1.2)	1.750 (44.5)	100	M61-R6610
M611, BMP61, 71*, TLS	Fig. 77	** PSPT-125-2-WT-R	White	22 to 16	0.046 (1.2)	0.110 (2.8)	0.125 (3.2)	0.046 (1.2)	2.000 (50.8)	70	M61-R6610
M611, BMP61, 71*, TLS	Fig. 44	** PSPT-187-1-WT	White	18 to 12	0.062 (1.6)	0.150 (3.8)	0.187 (4.8)	0.062 (1.6)	1.000 (25.4)	100	M61-R6610
M611, BMP61, 71*, TLS	Fig. 44	** PSPT-187-175-WT	White	18 to 12	0.062 (1.6)	0.150 (3.8)	0.187 (4.8)	0.062 (1.6)	1.750 (44.5)	100	M61-R6610
M611, BMP61, 71*, TLS	Fig. 77	** PSPT-187-2-WT-R	White	18 to 12	0.062 (1.6)	0.150 (3.8)	0.187 (4.8)	0.062 (1.6)	2.000 (50.8)	70	M61-R6610
M611, BMP61, 71*, TLS	Fig. 44	** PSPT-250-1-WT	White	16 to 10	0.094 (2.4)	0.215 (5.5)	0.250 (6.4)	0.094 (2.4)	1.000 (25.4)	100	M61-R6610
M611, BMP61, 71*, TLS	Fig. 44	** PSPT-250-175-WT	White	16 to 10	0.094 (2.4)	0.215 (5.5)	0.250 (6.4)	0.094 (2.4)	1.750 (44.5)	100	M61-R6610
M611, BMP61, 71*, TLS	Fig. 77	** PSPT-250-2-WT-R	White	16 to 10	0.094 (2.4)	0.215 (5.5)	0.250 (6.4)	0.094 (2.4)	2.000 (50.8)	70	M61-R6610
M611, BMP61, 71*, TLS	Fig. 44	** PSPT-375-1-WT	White	12 to 6	0.125 (3.2)	0.320 (8.1)	0.375 (9.5)	0.125 (3.2)	1.000 (25.4)	100	M61-R6610
M611, BMP61, 71*, TLS	Fig. 44	** PSPT-375-175-WT	White	12 to 6	0.125 (3.2)	0.320 (8.1)	0.375 (9.5)	0.125 (3.2)	1.750 (44.5)	100	M61-R6610
M611, BMP61, 71*, TLS	Fig. 77	** PSPT-375-2-WT-R	White	12 to 6	0.125 (3.2)	0.320 (8.1)	0.375 (9.5)	0.125 (3.2)	2.000 (50.8)	70	M61-R6610
M611, BMP61, 71*, TLS	Fig. 44	** PSPT-500-1-WT	White	8 to 1	0.187 (4.8)	0.450 (11.4)	0.500 (12.7)	0.187 (4.8)	1.000 (25.4)	100	M61-R6610
M611, BMP61, 71*, TLS	Fig. 44	** PSPT-500-175-WT	White	8 to 1	0.187 (4.8)	0.450 (11.4)	0.500 (12.7)	0.187 (4.8)	1.750 (44.5)	100	M61-R6610
M611, BMP61, 71*, TLS	Fig. 77	** PSPT-500-2-WT-R	White	8 to 1	0.187 (4.8)	0.450 (11.4)	0.500 (12.7)	0.187 (4.8)	2.000 (50.8)	70	M61-R6610
M611, BMP61, 71*, TLS	Fig. 44	** PSPT-750-1-WT	White	8 to 1	0.250 (6.4)	0.700 (17.8)	0.750 (19.1)	0.250 (6.4)	1.000 (25.4)	100	M61-R6610
M611, BMP61, 71*, TLS	Fig. 44	** PSPT-750-175-WT	White	8 to 1	0.250 (6.4)	0.700 (17.8)	0.750 (19.1)	0.250 (6.4)	1.750 (44.5)	100	M61-R6610
M611, BMP61, 71*, TLS	Fig. 77	** PSPT-750-2-WT-R	White	8 to 1	0.250 (6.4)	0.700 (17.8)	0.750 (19.1)	0.250 (6.4)	2.000 (50.8)	70	M61-R6610
M611, BMP61, 71*, TLS	Fig. 44	** PSPT-1000-1-WT	White	500 to 1	0.375 (9.5)	0.950 (24.1)	1.000 (25.4)	0.375 (9.5)	1.000 (25.4)	50	M61-R6610
M611, BMP61, 71*, TLS	Fig. 44	** PSPT-1000-175-WT	White	500 to 1	0.375 (9.5)	0.950 (24.1)	1.000 (25.4)	0.375 (9.5)	1.750 (44.5)	50	M61-R6610
M611, BMP61, 71*, TLS	Fig. 77	** PSPT-1000-2-WT-R	White	500 to 1	0.375 (9.5)	0.950 (24.1)	1.000 (25.4)	0.375 (9.5)	2.000 (50.8)	70	M61-R6610
M611, BMP61, 71*, TLS	Fig. 44	** PSPT-094-1-YL	Yellow	28 to 18	0.023 (0.6)	0.080 (2)	0.094 (2.4)	0.023 (0.6)	1.000 (25.4)	100	M61-R6610
M611, BMP61, 71*, TLS	Fig. 44	** PSPT-094-175-YL	Yellow	28 to 18	0.023 (0.6)	0.080 (2)	0.094 (2.4)	0.023 (0.6)	1.750 (44.5)	100	M61-R6610
M611, BMP61, 71*, TLS	Fig. 77	** PSPT-094-2-YL-R	Yellow	28 to 18	0.023 (0.6)	0.080 (2)	0.094 (2.4)	0.023 (0.6)	2.000 (50.8)	70	M61-R6610
M611, BMP61, 71*, TLS	Fig. 44	** PSPT-125-1-YL	Yellow	22 to 16	0.046 (1.2)	0.110 (2.8)	0.125 (3.2)	0.046 (1.2)	1.000 (25.4)	100	M61-R6610
M611, BMP61, 71*, TLS	Fig. 44	** PSPT-125-175-YL	Yellow	22 to 16	0.046 (1.2)	0.110 (2.8)	0.125 (3.2)	0.046 (1.2)	1.750 (44.5)	100	M61-R6610
M611, BMP61, 71*, TLS	Fig. 77	** PSPT-125-2-YL-R	Yellow	22 to 16	0.046 (1.2)	0.110 (2.8)	0.125 (3.2)	0.046 (1.2)	2.000 (50.8)	70	M61-R6610
M611, BMP61, 71*, TLS	Fig. 44	** PSPT-187-1-YL	Yellow	18 to 12	0.062 (1.6)	0.150 (3.8)	0.187 (4.8)	0.062 (1.6)	1.000 (25.4)	100	M61-R6610
M611, BMP61, 71*, TLS	Fig. 44	** PSPT-187-175-YL	Yellow	18 to 12	0.062 (1.6)	0.150 (3.8)	0.187 (4.8)	0.062 (1.6)	1.750 (44.5)	100	M61-R6610
M611, BMP61, 71*, TLS	Fig. 77	** PSPT-187-2-YL-R	Yellow	18 to 12	0.062 (1.6)	0.150 (3.8)	0.187 (4.8)	0.062 (1.6)	2.000 (50.8)	70	M61-R6610
M611, BMP61, 71*, TLS	Fig. 44	** PSPT-250-1-YL	Yellow	16 to 10	0.094 (2.4)	0.215 (5.5)	0.250 (6.4)	0.094 (2.4)	1.000 (25.4)	100	M61-R6610
M611, BMP61, 71*, TLS	Fig. 44	** PSPT-250-175-YL	Yellow	16 to 10	0.094 (2.4)	0.215 (5.5)	0.250 (6.4)	0.094 (2.4)	1.750 (44.5)	100	M61-R6610
M611, BMP61, 71*, TLS	Fig. 77	** PSPT-250-2-YL-R	Yellow	16 to 10	0.094 (2.4)	0.215 (5.5)	0.250 (6.4)	0.094 (2.4)	2.000 (50.8)	70	M61-R6610
M611, BMP61, 71*, TLS	Fig. 44	** PSPT-375-1-YL	Yellow	12 to 6	0.125 (3.2)	0.320 (8.1)	0.375 (9.5)	0.125 (3.2)	1.000 (25.4)	100	M61-R6610
M611, BMP61, 71*, TLS	Fig. 44	** PSPT-375-175-YL	Yellow	12 to 6	0.125 (3.2)	0.320 (8.1)	0.375 (9.5)	0.125 (3.2)	1.750 (44.5)	100	M61-R6610
M611, BMP61, 71*, TLS	Fig. 77	** PSPT-375-2-YL-R	Yellow	12 to 6	0.125 (3.2)	0.320 (8.1)	0.375 (9.5)	0.125 (3.2)	2.000 (50.8)	70	M61-R6610
M611, BMP61, 71*, TLS	Fig. 44	** PSPT-500-1-YL	Yellow	8 to 1	0.187 (4.8)	0.450 (11.4)	0.500 (12.7)	0.187 (4.8)	1.000 (25.4)	100	M61-R6610
M611, BMP61, 71*, TLS	Fig. 44	** PSPT-500-175-YL	Yellow	8 to 1	0.187 (4.8)	0.450 (11.4)	0.500 (12.7)	0.187 (4.8)	1.750 (44.5)	100	M61-R6610
M611, BMP61, 71*, TLS	Fig. 77	** PSPT-500-2-YL-R	Yellow	8 to 1	0.187 (4.8)	0.450 (11.4)	0.500 (12.7)	0.187 (4.8)	2.000 (50.8)	70	M61-R6610
M611, BMP61, 71*, TLS	Fig. 44	** PSPT-750-1-YL	Yellow	8 to 1	0.250 (6.4)	0.700 (17.8)	0.750 (19.1)	0.250 (6.4)	1.000 (25.4)	100	M61-R6610
M611, BMP61, 71*, TLS	Fig. 44	** PSPT-750-175-YL	Yellow	8 to 1	0.250 (6.4)	0.700 (17.8)	0.750 (19.1)	0.250 (6.4)	1.750 (44.5)	100	M61-R6610
M611, BMP61, 71*, TLS	Fig. 77	** PSPT-750-2-YL-R	Yellow	8 to 1	0.250 (6.4)	0.700 (17.8)	0.750 (19.1)	0.250 (6.4)	2.000 (50.8)	70	M61-R6610
M611, BMP61, 71*, TLS	Fig. 44	** PSPT-1000-1-YL	Yellow	500 to 1	0.375 (9.5)	0.950 (24.1)	1.000 (25.4)	0.375 (9.5)	1.000 (25.4)	50	M61-R6610
M611, BMP61, 71*, TLS	Fig. 44	** PSPT-1000-175-YL	Yellow	500 to 1	0.375 (9.5)	0.950 (24.1)	1.000 (25.4)	0.375 (9.5)	1.750 (44.5)	50	M61-R6610
M611, BMP61, 71*, TLS	Fig. 77	** PSPT-1000-2-YL-R	Yellow	500 to 1	0.375 (9.5)	0.950 (24.1)	1.000 (25.4)	0.375 (9.5)	2.000 (50.8)	70	M61-R6610

** ⚠️ WARNING: Cancer www.P65Warnings.ca.gov

Portable Printers

M611 / BMP61

Wire and Cable Materials

PSPT PermaSleeves (continued)

Fits Printers	Figure	Catalog #	Color	Approx. Wire Gauge	Minimum Wire Dia. Inch (mm)	Maximum Wire Dia. Inch (mm)	Diameter as Supplied B Inch (mm)	Recovered Diameter Inch (mm)	Sleeve Width A Inch (mm)	Qty. Per Roll	Rec. Ribbon (M611 / BMP61)
M611, BMP61, 71*, TLS	Fig. 77	** PSPT-094-2-BK-R	Black	28 to 18	0.023 (0.6)	0.080 (2)	0.094 (2.4)	0.023 (0.6)	2.000 (50.8)	70	M61-R6710-WT
M611, BMP61, 71*, TLS	Fig. 44	** PSPT-125-1-BK	Black	22 to 16	0.046 (1.2)	0.110 (2.8)	0.125 (3.2)	0.046 (1.2)	1.000 (25.4)	100	M61-R6710-WT
M611, BMP61, 71*, TLS	Fig. 77	** PSPT-125-2-BK-R	Black	22 to 16	0.046 (1.2)	0.110 (2.8)	0.125 (3.2)	0.046 (1.2)	2.000 (50.8)	70	M61-R6710-WT
M611, BMP61, 71*, TLS	Fig. 44	** PSPT-187-1-BK	Black	18 to 12	0.062 (1.6)	0.150 (3.8)	0.187 (4.8)	0.062 (1.6)	1.000 (25.4)	100	M61-R6710-WT
M611, BMP61, 71*, TLS	Fig. 44	** PSPT-187-175-BK	Black	18 to 12	0.062 (1.6)	0.150 (3.8)	0.187 (4.8)	0.062 (1.6)	1.750 (44.5)	100	M61-R6710-WT
M611, BMP61, 71*, TLS	Fig. 44	** PSPT-187-2-BK-R	Black	18 to 12	0.062 (1.6)	0.150 (3.8)	0.187 (4.8)	0.062 (1.6)	2.000 (50.8)	70	M61-R6710-WT
M611, BMP61, 71*, TLS	Fig. 44	** PSPT-250-1-BK	Black	16 to 10	0.094 (2.4)	0.215 (5.5)	0.250 (6.4)	0.094 (2.4)	1.000 (25.4)	100	M61-R6710-WT
M611, BMP61, 71*, TLS	Fig. 44	** PSPT-250-2-BK-R	Black	16 to 10	0.094 (2.4)	0.215 (5.5)	0.250 (6.4)	0.094 (2.4)	2.000 (50.8)	70	M61-R6710-WT
M611, BMP61, 71*, TLS	Fig. 44	** PSPT-375-2-BK-R	Black	12 to 6	0.125 (3.2)	0.320 (8.1)	0.375 (9.5)	0.125 (3.2)	2.000 (50.8)	70	M61-R6710-WT
M611, BMP61, 71*, TLS	Fig. 44	** PSPT-500-175-BK	Black	8 to 1	0.187 (4.8)	0.450 (11.4)	0.500 (12.7)	0.187 (4.8)	1.750 (44.5)	100	M61-R6710-WT
M611, BMP61, 71*, TLS	Fig. 77	** PSPT-500-2-BK-R	Black	8 to 1	0.187 (4.8)	0.450 (11.4)	0.500 (12.7)	0.187 (4.8)	2.000 (50.8)	70	M61-R6710-WT
M611, BMP61, 71*, TLS	Fig. 77	** PSPT-750-2-BK-R	Black	8 to 1	0.250 (6.4)	0.700 (17.8)	0.750 (19.1)	0.250 (6.4)	2.000 (50.8)	70	M61-R6710-WT
M611, BMP61, 71*, TLS	Fig. 44	** PSPT-1000-2-BK-R	Black	500 to 1	0.375 (9.5)	0.950 (24.1)	1.000 (25.4)	0.375 (9.5)	2.000 (50.8)	70	M61-R6710-WT
M611, BMP61, 71*, TLS	Fig. 44	** PSPT-1000-175-BK	Black	500 to 1	0.375 (9.5)	0.950 (24.1)	1.000 (25.4)	0.375 (9.5)	1.750 (44.5)	50	M61-R6710-WT
M611, BMP61, 71*, TLS	Fig. 44	** PSPT-094-1-BL	Blue	28 to 18	0.023 (0.6)	0.080 (2)	0.094 (2.4)	0.023 (0.6)	1.000 (25.4)	100	M61-R6710-WT
M611, BMP61, 71*, TLS	Fig. 44	** PSPT-094-175-BL	Blue	28 to 18	0.023 (0.6)	0.080 (2)	0.094 (2.4)	0.023 (0.6)	1.750 (44.5)	100	M61-R6710-WT
M611, BMP61, 71*, TLS	Fig. 44	** PSPT-125-1-BL	Blue	22 to 16	0.046 (1.2)	0.110 (2.8)	0.125 (3.2)	0.046 (1.2)	1.000 (25.4)	100	M61-R6710-WT
M611, BMP61, 71*, TLS	Fig. 44	** PSPT-187-1-BL	Blue	18 to 12	0.062 (1.6)	0.150 (3.8)	0.187 (4.8)	0.062 (1.6)	1.000 (25.4)	100	M61-R6710-WT
M611, BMP61, 71*, TLS	Fig. 44	** PSPT-375-1-BL	Blue	12 to 6	0.125 (3.2)	0.320 (8.1)	0.375 (9.5)	0.125 (3.2)	1.000 (25.4)	100	M61-R6710-WT
M611, BMP61, 71*, TLS	Fig. 44	** PSPT-375-175-BL	Blue	12 to 6	0.125 (3.2)	0.320 (8.1)	0.375 (9.5)	0.125 (3.2)	1.750 (44.5)	100	M61-R6710-WT
M611, BMP61, 71*, TLS	Fig. 44	** PSPT-500-175-BL	Blue	8 to 1	0.187 (4.8)	0.450 (11.4)	0.500 (12.7)	0.187 (4.8)	1.750 (44.5)	100	M61-R6710-WT
M611, BMP61, 71*, TLS	Fig. 44	** PSPT-1000-175-BL	Blue	500 to 1	0.375 (9.5)	0.950 (24.1)	1.000 (25.4)	0.375 (9.5)	1.750 (44.5)	50	M61-R6710-WT
M611, BMP61, 71*, TLS	Fig. 44	** PSPT-094-1-GR	Green	28 to 18	0.023 (0.6)	0.080 (2)	0.094 (2.4)	0.023 (0.6)	1.000 (25.4)	100	M61-R6710-WT
M611, BMP61, 71*, TLS	Fig. 44	** PSPT-125-175-GR	Green	22 to 16	0.046 (1.2)	0.110 (2.8)	0.125 (3.2)	0.046 (1.2)	1.750 (44.5)	100	M61-R6710-WT
M611, BMP61, 71*, TLS	Fig. 44	** PSPT-187-1-GR	Green	18 to 12	0.062 (1.6)	0.150 (3.8)	0.187 (4.8)	0.062 (1.6)	1.000 (25.4)	100	M61-R6710-WT
M611, BMP61, 71*, TLS	Fig. 44	** PSPT-187-175-GR	Green	18 to 12	0.062 (1.6)	0.150 (3.8)	0.187 (4.8)	0.062 (1.6)	1.750 (44.5)	100	M61-R6710-WT
M611, BMP61, 71*, TLS	Fig. 44	** PSPT-250-175-GR	Green	16 to 10	0.094 (2.4)	0.215 (5.5)	0.250 (6.4)	0.094 (2.4)	1.750 (44.5)	100	M61-R6710-WT
M611, BMP61, 71*, TLS	Fig. 44	** PSPT-375-175-GR	Green	12 to 6	0.125 (3.2)	0.320 (8.1)	0.375 (9.5)	0.125 (3.2)	1.750 (44.5)	100	M61-R6710-WT
M611, BMP61, 71*, TLS	Fig. 44	** PSPT-500-175-GR	Green	8 to 1	0.187 (4.8)	0.450 (11.4)	0.500 (12.7)	0.187 (4.8)	1.750 (44.5)	100	M61-R6710-WT
M611, BMP61, 71*, TLS	Fig. 44	** PSPT-1000-175-GR	Green	500 to 1	0.375 (9.5)	0.950 (24.1)	1.000 (25.4)	0.375 (9.5)	1.750 (44.5)	50	M61-R6710-WT
M611, BMP61, 71*, TLS	Fig. 44	** PSPT-094-1-OR	Orange	28 to 18	0.023 (0.6)	0.080 (2)	0.094 (2.4)	0.023 (0.6)	1.000 (25.4)	100	M61-R6610
M611, BMP61, 71*, TLS	Fig. 44	** PSPT-094-175-OR	Orange	28 to 18	0.023 (0.6)	0.080 (2)	0.094 (2.4)	0.023 (0.6)	1.750 (44.5)	100	M61-R6610
M611, BMP61, 71*, TLS	Fig. 44	** PSPT-125-175-OR	Orange	22 to 16	0.046 (1.2)	0.110 (2.8)	0.125 (3.2)	0.046 (1.2)	1.750 (44.5)	100	M61-R6610
M611, BMP61, 71*, TLS	Fig. 44	** PSPT-187-175-OR	Orange	18 to 12	0.062 (1.6)	0.150 (3.8)	0.187 (4.8)	0.062 (1.6)	1.750 (44.5)	100	M61-R6610
M611, BMP61, 71*, TLS	Fig. 44	** PSPT-250-1-OR	Orange	16 to 10	0.094 (2.4)	0.215 (5.5)	0.250 (6.4)	0.094 (2.4)	1.000 (25.4)	100	M61-R6610
M611, BMP61, 71*, TLS	Fig. 44	** PSPT-250-175-OR	Orange	16 to 10	0.094 (2.4)	0.215 (5.5)	0.250 (6.4)	0.094 (2.4)	1.750 (44.5)	100	M61-R6610
M611, BMP61, 71*, TLS	Fig. 44	** PSPT-375-1-OR	Orange	12 to 6	0.125 (3.2)	0.320 (8.1)	0.375 (9.5)	0.125 (3.2)	1.000 (25.4)	100	M61-R6610
M611, BMP61, 71*, TLS	Fig. 44	** PSPT-375-175-OR	Orange	12 to 6	0.125 (3.2)	0.320 (8.1)	0.375 (9.5)	0.125 (3.2)	1.750 (44.5)	100	M61-R6610
M611, BMP61, 71*, TLS	Fig. 44	** PSPT-500-1-OR	Orange	8 to 1	0.187 (4.8)	0.450 (11.4)	0.500 (12.7)	0.187 (4.8)	1.000 (25.4)	100	M61-R6610
M611, BMP61, 71*, TLS	Fig. 44	** PSPT-1000-175-OR	Orange	500 to 1	0.375 (9.5)	0.950 (24.1)	1.000 (25.4)	0.375 (9.5)	1.750 (44.5)	50	M61-R6610
M611, BMP61, 71*, TLS	Fig. 44	** PSPT-094-1-RD	Red	28 to 18	0.023 (0.6)	0.080 (2)	0.094 (2.4)	0.023 (0.6)	1.000 (25.4)	100	M61-R6710-WT
M611, BMP61, 71*, TLS	Fig. 44	** PSPT-125-1-RD	Red	22 to 16	0.046 (1.2)	0.110 (2.8)	0.125 (3.2)	0.046 (1.2)	1.000 (25.4)	100	M61-R6710-WT
M611, BMP61, 71*, TLS	Fig. 44	** PSPT-187-1-RD	Red	18 to 12	0.062 (1.6)	0.150 (3.8)	0.187 (4.8)	0.062 (1.6)	1.000 (25.4)	100	M61-R6710-WT
M611, BMP61, 71*, TLS	Fig. 44	** PSPT-187-175-RD	Red	18 to 12	0.062 (1.6)	0.150 (3.8)	0.187 (4.8)	0.062 (1.6)	1.750 (44.5)	100	M61-R6710-WT
M611, BMP61, 71*, TLS	Fig. 44	** PSPT-250-1-RD	Red	16 to 10	0.094 (2.4)	0.215 (5.5)	0.250 (6.4)	0.094 (2.4)	1.000 (25.4)	100	M61-R6710-WT
M611, BMP61, 71*, TLS	Fig. 44	** PSPT-250-175-RD	Red	16 to 10	0.094 (2.4)	0.215 (5.5)	0.250 (6.4)	0.094 (2.4)	1.750 (44.5)	100	M61-R6710-WT
M611, BMP61, 71*, TLS	Fig. 44	** PSPT-375-1-RD	Red	12 to 6	0.125 (3.2)	0.320 (8.1)	0.375 (9.5)	0.125 (3.2)	1.000 (25.4)	100	M61-R6710-WT
M611, BMP61, 71*, TLS	Fig. 44	** PSPT-375-175-RD	Red	12 to 6	0.125 (3.2)	0.320 (8.1)	0.375 (9.5)	0.125 (3.2)	1.750 (44.5)	100	M61-R6710-WT
M611, BMP61, 71*, TLS	Fig. 44	** PSPT-500-175-RD	Red	8 to 1	0.187 (4.8)	0.450 (11.4)	0.500 (12.7)	0.187 (4.8)	1.750 (44.5)	100	M61-R6710-WT
M611, BMP61, 71*, TLS	Fig. 44	** PSPT-1000-175-RD	Red	500 to 1	0.375 (9.5)	0.950 (24.1)	1.000 (25.4)	0.375 (9.5)	1.750 (44.5)	50	M61-R6710-WT
M611, BMP61, 71*, TLS	Fig. 44	** PSPT-250-1-PK	Pink	16 to 10	0.094 (2.4)	0.215 (5.5)	0.250 (6.4)	0.094 (2.4)	1.000 (25.4)	100	M61-R6610
M611, BMP61, 71*, TLS	Fig. 44	** PSPT-375-175-PK	Pink	12 to 6	0.125 (3.2)	0.320 (8.1)	0.375 (9.5)	0.125 (3.2)	1.750 (44.5)	100	M61-R6610
M611, BMP61, 71*, TLS	Fig. 44	** PSPT-1000-175-PK	Pink	500 to 1	0.375 (9.5)	0.950 (24.1)	1.000 (25.4)	0.375 (9.5)	1.750 (44.5)	50	M61-R6610
M611, BMP61, 71*, TLS	Fig. 44	** PSPT-187-1-VT	Violet	18 to 12	0.062 (1.6)	0.150 (3.8)	0.187 (4.8)	0.062 (1.6)	1.000 (25.4)	100	M61-R6710-WT
M611, BMP61, 71*, TLS	Fig. 44	** PSPT-1000-175-VT	Violet	500 to 1	0.375 (9.5)	0.950 (24.1)	1.000 (25.4)	0.375 (9.5)	1.750 (44.5)	50	M61-R6710-WT
M611, BMP61, 71*, TLS	Fig. 44	** PSPT-375-1-GY	Gray	12 to 6	0.125 (3.2)	0.320 (8.1)	0.375 (9.5)	0.125 (3.2)	1.000 (25.4)	100	M61-R6710-WT
M611, BMP61, 71*, TLS	Fig. 44	** PSPT-1000-175-GY	Gray	500 to 1	0.375 (9.5)	0.950 (24.1)	1.000 (25.4)	0.375 (9.5)	1.750 (44.5)	50	M61-R6710-WT
M611, BMP61, 71*, TLS	Fig. 44	** PSPT-500-175-BR	Brown	8 to 1	0.187 (4.8)	0.450 (11.4)	0.500 (12.7)	0.187 (4.8)	1.750 (44.5)	100	M61-R6710-WT
M611, BMP61, 71*, TLS	Fig. 44	** PSPT-1000-175-BR	Brown	500 to 1	0.375 (9.5)	0.950 (24.1)	1.000 (25.4)	0.375 (9.5)	1.750 (44.5)	50	M61-R6710-WT

** ⚠️ **WARNING:** Cancer www.P65Warnings.ca.gov

BradyPrinter M611 / BMP®61 Materials

BradyID.com/s36

Wire and Cable Materials

PermaSleeve® PSHT High-Heat Wire Markers (B-345)

2:1 heat-shrinkable wire marking sleeves specifically designed for high-temperature and low-vacuum outgassing applications. Made from irradiated high-temperature PVDF. Temp. range: -67° F to 437° F (-55° C to 225° C). RoHS compliant and UL recognized.

Meets specifications:

- NASA SP-R-0022A Outgassing Performance
- SAE-AS-81531
- MIL-STD-202

Tested per:

- SAE-AMS-DTL-23053/18, Class 2
- ASTM E162
- ASTM E662

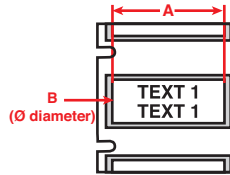

Figure 44



Fits Printers	Figure	Catalog #	Color	Approx. Wire Gauge	Minimum Wire Dia. Inch (mm)	Maximum Wire Dia. Inch (mm)	Diameter as Supplied B Inch (mm)	Recovered Diameter Inch (mm)	Sleeve Width A Inch (mm)	Qty. Per Roll	Rec. Ribbon (M611 / BMP61)
M611, BMP61, 71*, TLS	Fig. 44	PSHT-094-1-WT	White	26 to 18	0.031 (0.8)	0.080 (2)	0.094 (2.4)	0.031 (0.8)	1.000 (25.4)	100	M61-R6610
M611, BMP61, 71*, TLS	Fig. 44	PSHT-094-175-WT	White	26 to 18	0.031 (0.8)	0.080 (2)	0.094 (2.4)	0.031 (0.8)	1.750 (44.5)	100	M61-R6610
M611, BMP61, 71*, TLS	Fig. 44	PSHT-125-1-WT	White	20 to 16	0.063 (1.6)	0.110 (2.8)	0.125 (3.2)	0.063 (1.6)	1.000 (25.4)	100	M61-R6610
M611, BMP61, 71*, TLS	Fig. 44	PSHT-125-175-WT	White	20 to 16	0.063 (1.6)	0.110 (2.8)	0.125 (3.2)	0.063 (1.6)	1.750 (44.5)	100	M61-R6610
M611, BMP61, 71*, TLS	Fig. 44	PSHT-187-1-WT	White	16 to 12	0.094 (2.4)	0.150 (3.8)	0.187 (4.8)	0.094 (2.4)	1.000 (25.4)	100	M61-R6610
M611, BMP61, 71*, TLS	Fig. 44	PSHT-187-175-WT	White	16 to 12	0.094 (2.4)	0.150 (3.8)	0.187 (4.8)	0.094 (2.4)	1.750 (44.5)	100	M61-R6610
M611, BMP61, 71*, TLS	Fig. 44	PSHT-250-1-WT	White	14 to 8	0.125 (3.2)	0.215 (5.5)	0.250 (6.4)	0.125 (3.2)	1.000 (25.4)	100	M61-R6610
M611, BMP61, 71*, TLS	Fig. 44	PSHT-250-175-WT	White	14 to 8	0.125 (3.2)	0.215 (5.5)	0.250 (6.4)	0.125 (3.2)	1.750 (44.5)	100	M61-R6610
M611, BMP61, 71*, TLS	Fig. 44	PSHT-375-1-WT	White	10 to 6	0.187 (4.7)	0.320 (8.1)	0.375 (9.5)	0.187 (4.7)	1.000 (25.4)	100	M61-R6610
M611, BMP61, 71*, TLS	Fig. 44	PSHT-375-175-WT	White	10 to 6	0.187 (4.7)	0.320 (8.1)	0.375 (9.5)	0.187 (4.7)	1.750 (44.5)	100	M61-R6610
M611, BMP61, 71*, TLS	Fig. 44	PSHT-500-1-WT	White	8 to 1	0.250 (6.4)	0.450 (11.4)	0.500 (12.7)	0.250 (6.4)	1.000 (25.4)	100	M61-R6610
M611, BMP61, 71*, TLS	Fig. 44	PSHT-500-175-WT	White	8 to 1	0.250 (6.4)	0.450 (11.4)	0.500 (12.7)	0.250 (6.4)	1.750 (44.5)	100	M61-R6610
M611, BMP61, 71*, TLS	Fig. 44	PSHT-750-1-WT	White	4	0.375 (9.5)	0.700 (17.8)	0.750 (19.1)	0.375 (9.5)	1.000 (25.4)	100	M61-R6610
M611, BMP61, 71*, TLS	Fig. 44	PSHT-750-175-WT	White	4	0.375 (9.5)	0.700 (17.8)	0.750 (19.1)	0.375 (9.5)	1.750 (44.5)	100	M61-R6610
M611, BMP61, 71*, TLS	Fig. 44	PSHT-1000-1-WT	White	-	0.450 (11.4)	0.950 (24.1)	1.000 (25.4)	0.450 (11.4)	1.000 (25.4)	50	M61-R6610
M611, BMP61, 71*, TLS	Fig. 44	PSHT-1000-175-WT	White	-	0.450 (11.4)	0.950 (24.1)	1.000 (25.4)	0.450 (11.4)	1.750 (44.5)	50	M61-R6610
M611, BMP61, 71*, TLS	Fig. 44	PSHT-094-1-YL	Yellow	26 to 18	0.031 (0.8)	0.080 (2)	0.094 (2.4)	0.031 (0.8)	1.000 (25.4)	100	M61-R6610
M611, BMP61, 71*, TLS	Fig. 44	PSHT-094-175-YL	Yellow	26 to 18	0.031 (0.8)	0.080 (2)	0.094 (2.4)	0.031 (0.8)	1.750 (44.5)	100	M61-R6610
M611, BMP61, 71*, TLS	Fig. 44	PSHT-125-1-YL	Yellow	20 to 16	0.063 (1.6)	0.110 (2.8)	0.125 (3.2)	0.063 (1.6)	1.000 (25.4)	100	M61-R6610
M611, BMP61, 71*, TLS	Fig. 44	PSHT-125-175-YL	Yellow	20 to 16	0.063 (1.6)	0.110 (2.8)	0.125 (3.2)	0.063 (1.6)	1.750 (44.5)	100	M61-R6610
M611, BMP61, 71*, TLS	Fig. 44	PSHT-250-1-YL	Yellow	14 to 8	0.125 (3.2)	0.215 (5.5)	0.250 (6.4)	0.125 (3.2)	1.000 (25.4)	100	M61-R6610
M611, BMP61, 71*, TLS	Fig. 44	PSHT-250-175-YL	Yellow	14 to 8	0.125 (3.2)	0.215 (5.5)	0.250 (6.4)	0.125 (3.2)	1.750 (44.5)	100	M61-R6610
M611, BMP61, 71*, TLS	Fig. 44	PSHT-187-1-YL	Yellow	16 to 12	0.094 (2.4)	0.150 (3.8)	0.187 (4.8)	0.094 (2.4)	1.000 (25.4)	100	M61-R6610
M611, BMP61, 71*, TLS	Fig. 44	PSHT-187-175-YL	Yellow	16 to 12	0.094 (2.4)	0.150 (3.8)	0.187 (4.8)	0.094 (2.4)	1.750 (44.5)	100	M61-R6610
M611, BMP61, 71*, TLS	Fig. 44	PSHT-375-1-YL	Yellow	10 to 6	0.187 (4.7)	0.320 (8.1)	0.375 (9.5)	0.187 (4.7)	1.000 (25.4)	100	M61-R6610
M611, BMP61, 71*, TLS	Fig. 44	PSHT-375-175-YL	Yellow	10 to 6	0.187 (4.7)	0.320 (8.1)	0.375 (9.5)	0.187 (4.7)	1.750 (44.5)	100	M61-R6610
M611, BMP61, 71*, TLS	Fig. 44	PSHT-500-1-YL	Yellow	8 to 1	0.250 (6.4)	0.450 (11.4)	0.500 (12.7)	0.250 (6.4)	1.000 (25.4)	100	M61-R6610
M611, BMP61, 71*, TLS	Fig. 44	PSHT-500-175-YL	Yellow	8 to 1	0.250 (6.4)	0.450 (11.4)	0.500 (12.7)	0.250 (6.4)	1.750 (44.5)	100	M61-R6610
M611, BMP61, 71*, TLS	Fig. 44	PSHT-750-1-YL	Yellow	4	0.375 (9.5)	0.700 (17.8)	0.750 (19.1)	0.375 (9.5)	1.000 (25.4)	100	M61-R6610
M611, BMP61, 71*, TLS	Fig. 44	PSHT-750-175-YL	Yellow	4	0.375 (9.5)	0.700 (17.8)	0.750 (19.1)	0.375 (9.5)	1.750 (44.5)	100	M61-R6610
M611, BMP61, 71*, TLS	Fig. 44	PSHT-1000-1-YL	Yellow	-	0.450 (11.4)	0.950 (24.1)	1.000 (25.4)	0.450 (11.4)	1.000 (25.4)	50	M61-R6610
M611, BMP61, 71*, TLS	Fig. 44	PSHT-1000-175-YL	Yellow	-	0.450 (11.4)	0.950 (24.1)	1.000 (25.4)	0.450 (11.4)	1.750 (44.5)	50	M61-R6610
M611, BMP61, 71*, TLS	Fig. 44	PSHT-125-1-BK	Black	20 to 16	0.063 (1.6)	0.110 (2.8)	0.125 (3.2)	0.063 (1.6)	1.000 (25.4)	100	M61-R4410-WT
M611, BMP61, 71*, TLS	Fig. 44	PSHT-125-1-BL	Blue	20 to 16	0.063 (1.6)	0.110 (2.8)	0.125 (3.2)	0.063 (1.6)	1.000 (25.4)	100	M61-R4410-WT
M611, BMP61, 71*, TLS	Fig. 44	PSHT-125-175-BL	Blue	20 to 16	0.063 (1.6)	0.110 (2.8)	0.125 (3.2)	0.063 (1.6)	1.750 (44.5)	100	M61-R4410-WT
M611, BMP61, 71*, TLS	Fig. 44	PSHT-187-175-BL	Blue	16 to 12	0.094 (2.4)	0.150 (3.8)	0.187 (4.8)	0.094 (2.4)	1.750 (44.5)	100	M61-R4410-WT
M611, BMP61, 71*, TLS	Fig. 44	PSHT-125-1-PK	Pink	20 to 16	0.063 (1.6)	0.110 (2.8)	0.125 (3.2)	0.063 (1.6)	1.000 (25.4)	100	M61-R6610

Portable Printers

M611 / BMP61

Wire and Cable Materials

Terminal Block and Patch Panel Adhesive Strips (B-422, B-428, B-430, B-483 and B-498)

When using terminal block mode, printer can serialize and pre-space to your special thin widths to fit terminal blocks.

- **B-422 Glossy Polyester Material:** Permanent adhesive, good for powder-coated and textured surfaces. Best on flat surfaces. Temp. range: -40° F to 212° F (-40° C to 100° C). UL recognized
- **B-428 Metallized Polyester Material:** Permanent adhesive, silver finish. Temp. range: -40° F to 176° F (-40° C to 80° C). UL recognized
- **B-430 Clear Glossy Polyester Material:** Translucent, high performance polyester material with a glossy finish. Non-colored label with permanent adhesive. Good for general purpose thermal transfer printing
- **B-483 Polyester Material:** Permanent adhesive for powder-coated and textured surfaces. Best on flat surfaces. Temp. range: -40° F to 248° F (-40° C to 120° C). UL recognized
- **B-498 Repositionable Vinyl Cloth:** Adhesive and cloth backing offers excellent holding power, yet allow for clean removal and repositioning if necessary. Temp. range -40° F to 175° F (-40° C to 70° C). UL recognized

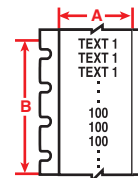
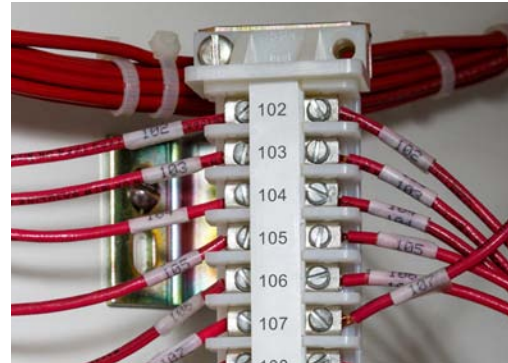

Figure 30

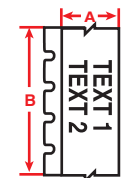

Figure 33

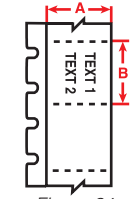

Figure 34
w/ perforations

Improved registration! The M61C- parts below come on a notched liner which helps the BMP61 printer achieve improved registration.

Fits Printers	Figure	Catalog #	B#	Material	Color	Label Width A Inch (mm)	Roll Length B Inch (mm)	Labels Per Roll	Rec. Ribbon (M611 / BMP61)
B-422 Polyester									
M611, BMP61, 71*	Fig. 33	M61C-375-422	B-422	Polyester	White	0.375 (9.53)	50 (15.24)	1 roll (cont.)	M61-R6010
M611, BMP61, 71*	Fig. 33	M61C-475-422	B-422	Polyester	White	0.475 (12.07)	50 (15.24)	1 roll (cont.)	M61-R6010
M611, BMP61, 71*	Fig. 33	M61C-500-422	B-422	Polyester	White	0.500 (12.7)	50 (15.24)	1 roll (cont.)	M61-R6010
M611, BMP61, 71*	Fig. 33	M61C-625-422	B-422	Polyester	White	0.625 (15.88)	50 (15.24)	1 roll (cont.)	M61-R6010
B-428 Metallized Polyester									
M611, BMP61, 71*	Fig. 33	M61C-500-428	B-428	Polyester	Light Gray	0.500 (12.7)	50 (15.24)	1 roll (cont.)	M61-R4310
B-430 Clear Polyester									
M611, BMP61, 71*	Fig. 33	M61C-375-430	B-430	Polyester	Clear	0.375 (9.53)	50 (15.24)	1 roll (cont.)	M61-R6010
M611, BMP61, 71*	Fig. 33	M61C-500-430	B-430	Polyester	Clear	0.500 (12.7)	50 (15.24)	1 roll (cont.)	M61-R6010
B-483 Ultra-Aggressive Polyester									
M611, BMP61, 71*	Fig. 30	M61C-500-483	B-483	Polyester	White	0.500 (12.7)	50 (15.24)	1 roll (cont.)	M61-R6010
B-498 Repositionable Vinyl Cloth									
M611, BMP61, 71*	Fig. 30	M61C-240-498	B-498	Vinyl Cloth	White	0.240 (6.1)	30 (9.14)	1 roll (cont.)	M61-R4310
M611, BMP61, 71*, TLS	Fig. 30	PTLTB-498-240	B-498	Vinyl Cloth	White	0.240 (6.1)	30 (9.14)	1 roll (cont.)	M61-R4310
M611, BMP61, 71*, TLS	Fig. 30	BPTLTB-498-240	B-498	Vinyl Cloth	White	0.240 (6.1)	300 (91.44)	1 roll (cont.)	M61-R4310
M611, BMP61, 71*	Fig. 30	M61C-318-498	B-498	Vinyl Cloth	White	0.318 (8.08)	30 (9.14)	1 roll (cont.)	M61-R4310
M611, BMP61, 71*, TLS	Fig. 30	PTLTB-498-318	B-498	Vinyl Cloth	White	0.318 (8.08)	30 (9.14)	1 roll (cont.)	M61-R4310
M611, BMP61, 71*, TLS	Fig. 30	BPTLTB-498-318	B-498	Vinyl Cloth	White	0.318 (8.08)	300 (91.44)	1 roll (cont.)	M61-R4310
M611, BMP61, 71*	Fig. 30	M61C-375-498	B-498	Vinyl Cloth	White	0.375 (9.53)	30 (9.14)	1 roll (cont.)	M61-R4310
M611, BMP61, 71*, TLS	Fig. 30	PTLTB-498-375	B-498	Vinyl Cloth	White	0.375 (9.53)	30 (9.14)	1 roll (cont.)	M61-R4310
M611, BMP61, 71*, TLS	Fig. 30	BPTLTB-498-375	B-498	Vinyl Cloth	White	0.375 (9.53)	300 (91.44)	1 roll (cont.)	M61-R4310
M611, BMP61, 71*, TLS	Fig. 30	PTL-8-498	B-498	Vinyl Cloth	White	0.500 (12.7)	30 (9.14)	1 roll (cont.)	M61-R4310

BradyPrinter M611 / BMP®61 Materials

BradyID.com/s36

Raised Panel Materials

Raised Panel and Push-Button Labels (B-593)

Glossy, foam-backed polyester with permanent adhesive and solvent resistance makes them a great replacement for engraved tags. Ideal for external push buttons, switches and internal connection points. Total label thickness: 0.0256 in. (0.650 mm). RoHS compliant and UL approved.

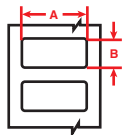

Figure 2

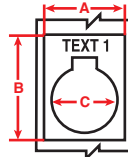

Figure 49



Portable Printers

M611 / BMP61

Fits Printers	Figure	Catalog #	B#	Material	Color	Label Width A Inch (mm)	Label Height B Inch (mm)	Hole Dia Inch (mm)	Labels Per Roll	Rec. Ribbon (M611 / BMP61)
Push button format										
M611, BMP61, 71*, TLS	Fig. 49	PTLEP-167-593	B-593	Polyester	White	1.200 (30.48)	1.500 (38.1)	0.886 (22.5)	100	M61-R6010
M611, BMP61, 71*, TLS	Fig. 49	PTLEP-168-593	B-593	Polyester	White	1.200 (30.48)	1.900 (48.3)	0.886 (22.5)	100	M61-R6010
M611, BMP61, 71*, TLS	Fig. 49	PTLEP-169-593	B-593	Polyester	White	1.800 (45.72)	1.800 (45.7)	1.201 (30.5)	100	M61-R6010
M611, BMP61, 71*, TLS	Fig. 49	PTLEP-167-593-YL	B-593	Polyester	Yellow	1.200 (30.48)	1.500 (38.1)	0.886 (22.5)	100	M61-R6010
M611, BMP61, 71*, TLS	Fig. 49	PTLEP-168-593-YL	B-593	Polyester	Yellow	1.200 (30.48)	1.900 (48.3)	0.886 (22.5)	100	M61-R6010
M611, BMP61, 71*, TLS	Fig. 49	PTLEP-169-593-YL	B-593	Polyester	Yellow	1.800 (45.72)	1.800 (45.7)	1.201 (30.5)	100	M61-R6010
M611, BMP61, 71*, TLS	Fig. 49	PTLEP-167-593-RD	B-593	Polyester	Red	1.200 (30.48)	1.500 (38.1)	0.886 (22.5)	100	M61-R4410-WT
M611, BMP61, 71*, TLS	Fig. 49	PTLEP-168-593-RD	B-593	Polyester	Red	1.200 (30.48)	1.900 (48.3)	0.886 (22.5)	100	M61-R4410-WT
M611, BMP61, 71*, TLS	Fig. 49	PTLEP-169-593-RD	B-593	Polyester	Red	1.800 (45.72)	1.800 (45.7)	1.201 (30.5)	100	M61-R4410-WT
M611, BMP61, 71*, TLS	Fig. 49	PTLEP-167-593-GN	B-593	Polyester	Green	1.200 (30.48)	1.500 (38.1)	0.886 (22.5)	100	M61-R4410-WT
M611, BMP61, 71*, TLS	Fig. 49	PTLEP-168-593-GN	B-593	Polyester	Green	1.200 (30.48)	1.900 (48.3)	0.886 (22.5)	100	M61-R4410-WT
M611, BMP61, 71*, TLS	Fig. 49	PTLEP-169-593-GN	B-593	Polyester	Green	1.800 (45.72)	1.800 (45.7)	1.201 (30.5)	100	M61-R4410-WT
M611, BMP61, 71*, TLS	Fig. 49	PTLEP-167-593-BK	B-593	Polyester	Black	1.200 (30.48)	1.500 (38.1)	0.886 (22.5)	100	M61-R4410-WT
M611, BMP61, 71*, TLS	Fig. 49	PTLEP-168-593-BK	B-593	Polyester	Black	1.200 (30.48)	1.900 (48.3)	0.886 (22.5)	100	M61-R4410-WT
M611, BMP61, 71*, TLS	Fig. 49	PTLEP-169-593-BK	B-593	Polyester	Black	1.800 (45.72)	1.800 (45.7)	1.201 (30.5)	100	M61-R4410-WT
Rectangular format										
M611, BMP61, 71*, TLS	Fig. 2	PTLEP-173-593	B-593	Polyester	White	1.000 (25.4)	2.000 (50.8)	-	100	M61-R6010
M611, BMP61, 71*, TLS	Fig. 2	PTLEP-176-593	B-593	Polyester	White	1.000 (25.4)	3.000 (76.2)	-	50	M61-R6010
M611, BMP61, 71*, TLS	Fig. 2	PTLEP-174-593	B-593	Polyester	White	1.000 (25.4)	4.000 (101.6)	-	50	M61-R6010
M611, BMP61, 71*, TLS	Fig. 2	PTLEP-171-593	B-593	Polyester	White	1.060 (26.9)	0.490 (12.4)	-	200	M61-R6010
M611, BMP61, 71*, TLS	Fig. 2	PTLEP-173-593-YL	B-593	Polyester	Yellow	1.000 (25.4)	2.000 (50.8)	-	100	M61-R6010
M611, BMP61, 71*, TLS	Fig. 2	PTLEP-176-593-YL	B-593	Polyester	Yellow	1.000 (25.4)	3.000 (76.2)	-	50	M61-R6010
M611, BMP61, 71*, TLS	Fig. 2	PTLEP-174-593-YL	B-593	Polyester	Yellow	1.000 (25.4)	4.000 (101.6)	-	50	M61-R6010
M611, BMP61, 71*, TLS	Fig. 2	PTLEP-171-593-YL	B-593	Polyester	Yellow	1.060 (26.9)	0.490 (12.4)	-	200	M61-R6010
M611, BMP61, 71*, TLS	Fig. 2	PTLEP-173-593-RD	B-593	Polyester	Red	1.000 (25.4)	2.000 (50.8)	-	100	M61-R4410-WT
M611, BMP61, 71*, TLS	Fig. 2	PTLEP-176-593-RD	B-593	Polyester	Red	1.000 (25.4)	3.000 (76.2)	-	50	M61-R4410-WT
M611, BMP61, 71*, TLS	Fig. 2	PTLEP-174-593-RD	B-593	Polyester	Red	1.000 (25.4)	4.000 (101.6)	-	50	M61-R4410-WT
M611, BMP61, 71*, TLS	Fig. 2	PTLEP-171-593-RD	B-593	Polyester	Red	1.060 (26.9)	0.490 (12.4)	-	200	M61-R4410-WT
M611, BMP61, 71*, TLS	Fig. 2	PTLEP-173-593-GN	B-593	Polyester	Green	1.000 (25.4)	2.000 (50.8)	-	100	M61-R4410-WT
M611, BMP61, 71*, TLS	Fig. 2	PTLEP-176-593-GN	B-593	Polyester	Green	1.000 (25.4)	3.000 (76.2)	-	50	M61-R4410-WT
M611, BMP61, 71*, TLS	Fig. 2	PTLEP-174-593-GN	B-593	Polyester	Green	1.000 (25.4)	4.000 (101.6)	-	50	M61-R4410-WT
M611, BMP61, 71*, TLS	Fig. 2	PTLEP-171-593-GN	B-593	Polyester	Green	1.060 (26.9)	0.490 (12.4)	-	200	M61-R4410-WT
M611, BMP61, 71*, TLS	Fig. 2	PTLEP-173-593-SL	B-593	Polyester	Silver	1.000 (25.4)	2.000 (50.8)	-	100	M61-R6010
M611, BMP61, 71*, TLS	Fig. 2	PTLEP-174-593-SL	B-593	Polyester	Silver	1.000 (25.4)	4.000 (101.6)	-	50	M61-R6010
M611, BMP61, 71*, TLS	Fig. 2	PTLEP-171-593-SL	B-593	Polyester	Silver	1.060 (26.9)	0.490 (12.4)	-	200	M61-R6010
M611, BMP61, 71*, TLS	Fig. 2	PTLEP-173-593-BK	B-593	Polyester	Black	1.000 (25.4)	2.000 (50.8)	-	100	M61-R4410-WT
M611, BMP61, 71*, TLS	Fig. 2	PTLEP-176-593-BK	B-593	Polyester	Black	1.000 (25.4)	3.000 (76.2)	-	50	M61-R4410-WT
M611, BMP61, 71*, TLS	Fig. 2	PTLEP-174-593-BK	B-593	Polyester	Black	1.000 (25.4)	4.000 (101.6)	-	50	M61-R4410-WT
M611, BMP61, 71*, TLS	Fig. 2	PTLEP-171-593-BK	B-593	Polyester	Black	1.060 (26.9)	0.490 (12.4)	-	200	M61-R4410-WT

Due to the rigid nature of B-593 material, labels feed into the printer through the bulk media slot at the top.



Asset Tracking Materials

Metallized Asset Tracking Labels (B-428, B-435 and B-486)

- **B-428 Metallized Polyester Material:** Permanent adhesive, silver finish. Temp. range: -40° F to 176° F (-40° C to 80° C). UL recognized
- **B-435 Glossy Metallized Polyester Material:** Withstands numerous solvents and variable temps. Ideal for serial and rating plate applications with name-plate quality and a metal looking finish
- **B-486 Ultra-Aggressive Metallized Polyester Material:** High adhesion to textured metals, powder-coated surfaces and low-surface energy plastics. Withstands numerous solvents and variable temps
- **B-8591 Outdoor Polyester Material:** Permanent adhesive, 12-year outdoor durability, resists UV, abrasion and fluids

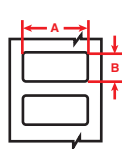
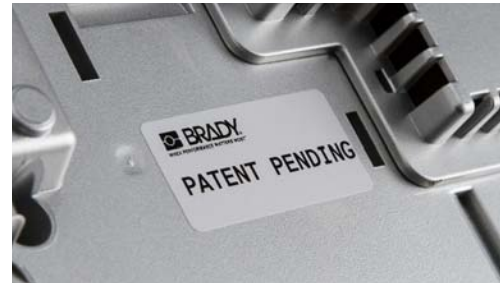

Figure 2

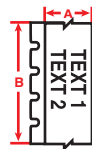

Figure 33

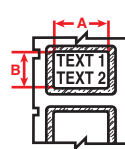

Figure 40
w/ overlaminate

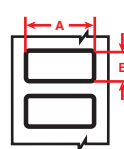

Figure 46
w/ black border

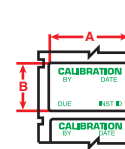

Figure 51

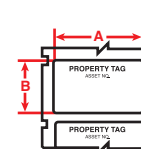

Figure 54

Fits Printers	Figure	Catalog #	B#	Material	Color	Label Width A Inch (mm)	Label Height B Inch (mm)	Labels Per Roll	Rec. Ribbon (M611 / BMP61)
B-428 Metallized Polyester									
M611, BMP61, 71*, TLS	Fig. 33	PTL-8-428	B-428	Polyester	Light Gray	0.500 (12.7)	50 ft. (15.24 m)	1 roll (cont.)	M61-R4310
M611, BMP61, 71*, TLS	Fig. 51	PTL-30-428-CALI	B-428	Polyester	Light Gray	0.750 (19.05)	1.500 (38.1)	250	M61-R4310
M611, BMP61, 71*, TLS	Fig. 2	PTL-15-428	B-428	Polyester	Light Gray	1.000 (25.4)	0.275 (7)	750	M61-R4310
M611, BMP61, 71*, TLS	Fig. 2	PTL-17-428	B-428	Polyester	Light Gray	1.000 (25.4)	0.500 (12.7)	500	M61-R4310
M611, BMP61, 71*, TLS	Fig. 40	PTPSL-17-428	B-428	Polyester	Light Gray	1.000 (25.4)	0.500 (12.7)	500	M61-R4310
M611, BMP61, 71*, TLS	Fig. 2	PTL-22-428	B-428	Polyester	Light Gray	1.000 (25.4)	3.000 (76.2)	100	M61-R4310
M611, BMP61, 71*, TLS	Fig. 46	PTL-24-428-BK	B-428	Polyester	Light Gray	1.130 (28.7)	0.500 (12.7)	500	M61-R4310
M611, BMP61, 71*, TLS	Fig. 2	PTL-26-428	B-428	Polyester	Light Gray	1.250 (31.75)	2.750 (69.9)	100	M61-R4310
M611, BMP61, 71*, TLS	Fig. 40	PTPSL-26-428	B-428	Polyester	Light Gray	1.250 (31.8)	2.750 (69.85)	100	M61-R4310
M611, BMP61, 71*, TLS	Fig. 2	PTL-29-428	B-428	Polyester	Light Gray	1.500 (38.1)	0.500 (12.7)	500	M61-R4310
M611, BMP61, 71*, TLS	Fig. 54	PTL-35-428-PROP	B-428	Polyester	Light Gray	1.630 (41.4)	0.750 (19.1)	250	M61-R4310
M611, BMP61, 71*, TLS	Fig. 40	PTPSL-50-428	B-428	Polyester	Light Gray	1.650 (41.9)	3.000 (76.2)	100	M61-R4310
M611, BMP61, 71*, TLS	Fig. 2	PTL-37-428	B-428	Polyester	Light Gray	1.900 (48.3)	3.000 (76.2)	100	M61-R4310
M611, BMP61, 71*, TLS	Fig. 2	PTL-38-428	B-428	Polyester	Light Gray	1.900 (48.3)	4.000 (101.6)	100	M61-R4310
M611, BMP61, 71*, TLS	Fig. 40	PTPSL-20-428	B-428	Polyester	Light Gray	2.000 (50.8)	1.000 (25.4)	100	M61-R4310
M611, BMP61, 71*, TLS	Fig. 2	PTL-20-428	B-428	Polyester	Light Gray	2.000 (50.8)	1.000 (25.4)	100	M61-R4310
B-435 Glossy Metallized Polyester									
M611, BMP61, 71*, TLS	Fig. 2	PTL-16-435	B-435	Polyester	Silver	1.000 (25.4)	0.375 (9.5)	500	M61-R6010
M611, BMP61, 71*, TLS	Fig. 2	PTL-17-435	B-435	Polyester	Silver	1.000 (25.4)	0.500 (12.7)	500	M61-R6010
M611, BMP61, 71*, TLS	Fig. 2	PTL-29-435	B-435	Polyester	Silver	1.500 (38.1)	0.500 (12.7)	500	M61-R6010
M611, BMP61, 71*, TLS	Fig. 2	PTL-30-435	B-435	Polyester	Silver	1.500 (38.1)	0.750 (19.1)	250	M61-R6010
M611, BMP61, 71*, TLS	Fig. 2	PTL-31-435	B-435	Polyester	Silver	1.500 (38.1)	1.000 (25.4)	250	M61-R6010
M611, BMP61, 71*, TLS	Fig. 2	PTL-32-435	B-435	Polyester	Silver	1.500 (38.1)	1.500 (38.1)	250	M61-R6010
M611, BMP61, 71*, TLS	Fig. 2	PTL-37-435	B-435	Polyester	Silver	1.900 (48.3)	3.000 (76.2)	100	M61-R6010
M611, BMP61, 71*, TLS	Fig. 2	PTL-38-435	B-435	Polyester	Silver	1.900 (48.3)	4.000 (101.6)	100	M61-R6010
M611, BMP61, 71*, TLS	Fig. 2	PTL-20-435	B-435	Polyester	Silver	2.000 (50.8)	1.000 (25.4)	100	M61-R6010
B-486 Ultra-Aggressive Metallized Polyester									
M611, BMP61, 71*, TLS	Fig. 2	PTL-16-486	B-486	Polyester	Light Gray	1.000 (25.4)	0.375 (9.5)	500	M61-R4310
M611, BMP61, 71*, TLS	Fig. 2	PTL-17-486	B-486	Polyester	Light Gray	1.000 (25.4)	0.500 (12.7)	500	M61-R4310
M611, BMP61, 71*, TLS	Fig. 2	PTL-19-486	B-486	Polyester	Light Gray	1.000 (25.4)	1.000 (25.4)	250	M61-R4310
M611, BMP61, 71*, TLS	Fig. 46	PTL-24-486-BK	B-486	Polyester	Light Gray	1.130 (28.7)	0.500 (12.7)	500	M61-R4310
M611, BMP61, 71*, TLS	Fig. 2	PTL-29-486	B-486	Polyester	Light Gray	1.500 (38.1)	0.500 (12.7)	500	M61-R4310
M611, BMP61, 71*, TLS	Fig. 2	PTL-30-486	B-486	Polyester	Light Gray	1.500 (38.1)	0.750 (19.1)	250	M61-R4310
M611, BMP61, 71*, TLS	Fig. 2	PTL-31-486	B-486	Polyester	Light Gray	1.500 (38.1)	1.000 (25.4)	250	M61-R4310
M611, BMP61, 71*, TLS	Fig. 2	PTL-32-486	B-486	Polyester	Light Gray	1.500 (38.1)	1.500 (38.1)	250	M61-R4310
M611, BMP61, 71*, TLS	Fig. 2	PTL-37-486	B-486	Polyester	Light Gray	1.900 (48.3)	3.000 (76.2)	100	M61-R4310
M611, BMP61, 71*, TLS	Fig. 2	PTL-38-486	B-486	Polyester	Light Gray	1.900 (48.3)	4.000 (101.6)	100	M61-R4310
M611, BMP61, 71*, TLS	Fig. 2	PTL-20-486	B-486	Polyester	Light Gray	2.000 (50.8)	1.000 (25.4)	100	M61-R4310
B-8591 Outdoor Polyester									
M611, BMP61	Fig. 2	M61-196-8591-SL	B-8591	Polyester	Silver	1.180 (30.0)	1.970 (50.0)	100	M61-R6610

BradyPrinter M611 / BMP®61 Materials

BradyID.com/s36

Asset Tracking Materials

Non-Metallized Asset Tracking Labels (B-422, B-423, B-430 and B-483)

- **B-422 Polyester Material:** Permanent adhesive, good for powder-coated and textured surfaces. Temp. range: -40° F to 212° F (-40° C to 100° C). UL recognized
- **B-423 Glossy White Polyester Material:** UL recognized for outdoor use on glass, thermoset polyester plastic and polyvinyl fluoride plastic
- **B-430 Clear Polyester Material:** High-performance glossy polyester material with permanent adhesive. Good for general purpose thermal transfer printing
- **B-483 Ultra-Aggressive Polyester Material:** Permanent adhesive for powder-coated and textured surfaces. Temp. range: -40° F to 248° F (-40° C to 120° C). UL recognized
- **B-8459 Polyester Material:** Permanent adhesive, excellent resistance to most chemicals, oils and water. Temp. range: -40° F to 212° F (-40° C to 100° C). UL recognized
- **B-8591 Outdoor Polyester Material:** Permanent adhesive, 12-year outdoor durability, resists UV, abrasion and fluids

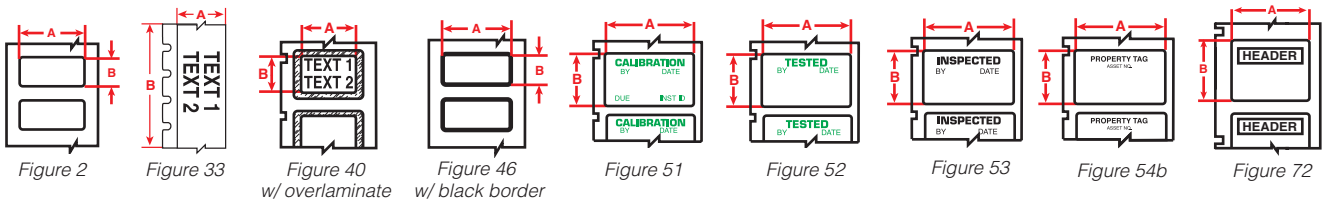

Fits Printers	Figure	Catalog #	B#	Material	Color	Label Width A Inch (mm)	Label Height B Inch (mm)	Labels Per Roll	Rec. Ribbon (M611 / BMP61)
B-422 Permanent Polyester									
M611, BMP61, 71*, TLS	Fig. 2	PTL-39-422	B-422	Polyester	White	0.375 (9.53)	0.600 (15.2)	750	M61-R6010
M611, BMP61, 71*, TLS	Fig. 33	PTL-46-422	B-422	Polyester	White	0.375 (9.53)	50 ft. (15.24 m)	1 roll (cont.)	M61-R6010
M611, BMP61, 71*, TLS	Fig. 2	PTL-5-422	B-422	Polyester	White	0.500 (12.7)	0.200 (5.1)	750	M61-R6010
M611, BMP61, 71*, TLS	Fig. 2	PTL-44-422	B-422	Polyester	White	0.500 (12.7)	0.375 (9.5)	500	M61-R6010
M611, BMP61, 71*, TLS	Fig. 2	PTL-7-422	B-422	Polyester	White	0.500 (12.7)	0.500 (12.7)	500	M61-R6010
M611, BMP61, 71*, TLS	Fig. 33	PTL-8-422	B-422	Polyester	White	0.500 (12.7)	50 ft. (15.24 m)	1 roll (cont.)	M61-R6010
M611, BMP61, 71*, TLS	Fig. 2	PTL-16-422	B-422	Polyester	White	1.000 (25.4)	0.375 (9.5)	500	M61-R6010
M611, BMP61, 71*, TLS	Fig. 2	PTL-17-422	B-422	Polyester	White	1.000 (25.4)	0.500 (12.7)	500	M61-R6010
M611, BMP61, 71*, TLS	Fig. 2	PTL-19-422	B-422	Polyester	White	1.000 (25.4)	1.000 (25.4)	250	M61-R6010
M611, BMP61, 71*, TLS	Fig. 2	PTL-22-422	B-422	Polyester	White	1.000 (25.4)	3.000 (76.2)	100	M61-R6010
M611, BMP61, 71*, TLS	Fig. 2	PTL-23-422	B-422	Polyester	White	1.000 (25.4)	4.000 (101.6)	100	M61-R6010
M611, BMP61, 71*, TLS	Fig. 33	PTL-42-422	B-422	Polyester	White	1.000 (25.4)	50 ft. (15.24 m)	1 roll (cont.)	M61-R6010
M611, BMP61, 71*, TLS	Fig. 2	PTL-45-422	B-422	Polyester	White	1.500 (38.1)	0.375 (9.5)	500	M61-R6010
M611, BMP61, 71*, TLS	Fig. 2	PTL-29-422	B-422	Polyester	White	1.500 (38.1)	0.500 (12.7)	500	M61-R6010
M611, BMP61, 71*, TLS	Fig. 2	PTL-30-422	B-422	Polyester	White	1.500 (38.1)	0.750 (19.1)	250	M61-R6010
M611, BMP61, 71*, TLS	Fig. 2	PTL-32-422	B-422	Polyester	White	1.500 (38.1)	1.500 (38.1)	250	M61-R6010
M611, BMP61, 71*, TLS	Fig. 54	PTL-35-422-PROP	B-422	Polyester	White	1.630 (41.4)	0.750 (19.1)	250	M61-R6010
M611, BMP61, 71*, TLS	Fig. 33	PTL-43-422	B-422	Polyester	White	1.900 (48.26)	50 ft. (15.24 m)	1 roll (cont.)	M61-R6010
M611, BMP61, 71*, TLS	Fig. 2	PTL-37-422	B-422	Polyester	White	1.900 (48.3)	3.000 (76.2)	100	M61-R6010
M611, BMP61, 71*, TLS	Fig. 2	PTL-38-422	B-422	Polyester	White	1.900 (48.3)	4.000 (101.6)	100	M61-R6010
M611, BMP61, 71*, TLS	Fig. 2	PTL-20-422	B-422	Polyester	White	2.000 (50.8)	1.000 (25.4)	100	M61-R6010
B-422 PermsShield Polyester with overlaminated layer									
M611, BMP61, 71*, TLS	Fig. 40	PTPSL-17-422	B-422	Polyester	White	1.000 (25.4)	0.500 (12.7)	500	M61-R6010
M611, BMP61, 71*, TLS	Fig. 40	PTPSL-26-422	B-422	Polyester	White	1.250 (31.8)	2.750 (69.85)	100	M61-R6010
M611, BMP61, 71*, TLS	Fig. 40	PTPSL-50-422	B-422	Polyester	White	1.650 (41.9)	3.000 (76.2)	100	M61-R6010
M611, BMP61, 71*, TLS	Fig. 40	PTPSL-20-422	B-422	Polyester	White	2.000 (50.8)	1.000 (25.4)	100	M61-R6010
B-423 Glossy Permanent Polyester									
M611, BMP61, 71*, TLS	Fig. 2	PTL-1-423	B-423	Polyester	White	0.250 (6.35)	0.250 (6.4)	750	M61-R6010
M611, BMP61, 71*, TLS	Fig. 2	PTL-3-423	B-423	Polyester	White	0.375 (9.53)	0.375 (9.5)	500	M61-R6010
M611, BMP61, 71*, TLS	Fig. 2	PTL-4-423	B-423	Polyester	White	0.400 (10.2)	0.400 (10.2)	500	M61-R6010
M611, BMP61, 71*, TLS	Fig. 2	PTL-5-423	B-423	Polyester	White	0.500 (12.7)	0.200 (5.1)	750	M61-R6010
M611, BMP61, 71*, TLS	Fig. 2	PTL-6-423	B-423	Polyester	White	0.500 (12.7)	0.275 (7)	750	M61-R6010
M611, BMP61, 71*, TLS	Fig. 2	PTL-7-423	B-423	Polyester	White	0.500 (12.7)	0.500 (12.7)	500	M61-R6010
M611, BMP61, 71*, TLS	Fig. 33	PTL-8-423	B-423	Polyester	White	0.500 (12.7)	50 ft. (15.24 m)	1 roll (cont.)	M61-R6010
M611, BMP61, 71*, TLS	Fig. 2	PTL-9-423	B-423	Polyester	White	0.650 (16.51)	0.200 (5.1)	750	M61-R6010
M611, BMP61, 71*, TLS	Fig. 2	PTL-10-423	B-423	Polyester	White	0.750 (19.05)	0.250 (6.4)	750	M61-R6010
M611, BMP61, 71*, TLS	Fig. 2	PTL-13-423	B-423	Polyester	White	0.900 (22.86)	0.250 (6.4)	750	M61-R6010
M611, BMP61, 71*, TLS	Fig. 2	PTL-14-423	B-423	Polyester	White	1.000 (25.4)	0.187 (4.7)	750	M61-R6010
M611, BMP61, 71*, TLS	Fig. 2	PTL-15-423	B-423	Polyester	White	1.000 (25.4)	0.275 (7)	750	M61-R6010
M611, BMP61, 71*, TLS	Fig. 2	PTL-16-423	B-423	Polyester	White	1.000 (25.4)	0.375 (9.5)	500	M61-R6010
M611, BMP61, 71*, TLS	Fig. 51	PTL-30-423-CALI	B-423	Polyester	White	1.500 (38.1)	0.750 (19.05)	250	M61-R6010
M611, BMP61, 71*, TLS	Fig. 52	PTL-30-423-TEST	B-423	Polyester	White	1.500 (38.1)	0.750 (19.05)	250	M61-R6010
M611, BMP61, 71*, TLS	Fig. 53	PTL-30-423-INSP	B-423	Polyester	White	1.500 (38.1)	0.750 (19.05)	250	M61-R6010
M611, BMP61, 71*, TLS	Fig. 2	PTL-17-423	B-423	Polyester	White	1.000 (25.4)	0.500 (12.7)	500	M61-R6010
M611, BMP61, 71*, TLS	Fig. 2	PTL-19-423	B-423	Polyester	White	1.000 (25.4)	1.000 (25.4)	250	M61-R6010
M611, BMP61, 71*, TLS	Fig. 2	PTL-22-423	B-423	Polyester	White	1.000 (25.4)	3.000 (76.2)	100	M61-R6010

Portable Printers

M611 / BMP61

Non-Metalized Asset Tracking Labels (continued)

Fits Printers	Figure	Catalog #	B#	Material	Color	Label Width A Inch (mm)	Label Height B Inch (mm)	Labels Per Roll	Rec. Ribbon (M611 / BMP61)
M611, BMP61, 71*, TLS	Fig. 2	PTL-23-423	B-423	Polyester	White	1.000 (25.4)	4.000 (101.6)	100	M61-R6010
M611, BMP61, 71*, TLS	Fig. 46	PTL-24-423-BK	B-423	Polyester	White	1.130 (28.7)	0.500 (12.7)	500	M61-R6010
M611, BMP61, 71*, TLS	Fig. 2	PTL-25-423	B-423	Polyester	White	1.250 (31.75)	0.250 (6.4)	750	M61-R6010
M611, BMP61, 71*, TLS	Fig. 2	PTL-26-423	B-423	Polyester	White	1.250 (31.75)	2.750 (69.9)	100	M61-R6010
M611, BMP61, 71*, TLS	Fig. 2	PTL-27-423	B-423	Polyester	White	1.500 (38.1)	0.125 (3.2)	750	M61-R6010
M611, BMP61, 71*, TLS	Fig. 2	PTL-28-423	B-423	Polyester	White	1.500 (38.1)	0.250 (6.4)	750	M61-R6010
M611, BMP61, 71*, TLS	Fig. 2	PTL-29-423	B-423	Polyester	White	1.500 (38.1)	0.500 (12.7)	500	M61-R6010
M611, BMP61	Fig. 2	M61-30-423	B-423	Polyester	White	1.500 (38.1)	0.750 (19.05)	250	M61-R6010
M611, BMP61, 71*, TLS	Fig. 2	PTL-31-423	B-423	Polyester	White	1.500 (38.1)	1.000 (25.4)	250	M61-R6010
M611, BMP61, 71*, TLS	Fig. 2	PTL-32-423	B-423	Polyester	White	1.500 (38.1)	1.500 (38.1)	250	M61-R6010
M611, BMP61, 71*, TLS	Fig. 54	PTL-35-423-PROP	B-423	Polyester	White	1.630 (41.4)	0.750 (19.1)	250	M61-R6010
M611, BMP61	Fig. 2	M61-52-423	B-423	Polyester	White	1.900 (48.3)	0.600 (15.2)	250	M61-R6010
M611, BMP61, 71*, TLS	Fig. 2	PTL-37-423	B-423	Polyester	White	1.900 (48.3)	3.000 (76.2)	100	M61-R6010
M611, BMP61, 71*, TLS	Fig. 2	PTL-38-423	B-423	Polyester	White	1.900 (48.3)	4.000 (101.6)	100	M61-R6010
M611, BMP61, 71*, TLS	Fig. 2	PTL-2-423	B-423	Polyester	White	2.000 (50.8)	0.250 (6.4)	100	M61-R6010
M611, BMP61	Fig. 2	M61-61-423	B-423	Polyester	White	2.000 (50.8)	0.500 (12.7)	100	M61-R6010
M611, BMP61, 71*, TLS	Fig. 2	PTL-20-423	B-423	Polyester	White	2.000 (50.8)	1.000 (25.4)	100	M61-R6010
B-430 Clear Polyester									
M611, BMP61, 71*, TLS	Fig. 2	PTL-71-430	B-430	Polyester	Clear	0.350 (8.89)	0.200 (5.1)	750	M61-R6010
M611, BMP61, 71*, TLS	Fig. 34	PTL-39-430	B-430	Polyester	Clear	0.375 (9.53)	0.600 (15.2)	750	M61-R6010
M611, BMP61	Fig. 33	M61C-375-430	B-430	Polyester	Clear	0.375 (9.53)	50 ft. (15.24 m)	1 roll (cont.)	M61-R6010
M611, BMP61, 71*, TLS	Fig. 33	PTL-46-430	B-430	Polyester	Clear	0.375 (9.53)	50 ft. (15.24 m)	1 roll (cont.)	M61-R6010
M611, BMP61, 71*, TLS	Fig. 2	PTL-6-430	B-430	Polyester	Clear	0.500 (12.7)	0.275 (7)	750	M61-R6010
M611, BMP61, 71*, TLS	Fig. 2	PTL-44-430	B-430	Polyester	Clear	0.500 (12.7)	0.375 (9.5)	500	M61-R6010
M611, BMP61, 71*, TLS	Fig. 2	PTL-7-430	B-430	Polyester	Clear	0.500 (12.7)	0.500 (12.7)	500	M61-R6010
M611, BMP61	Fig. 33	M61C-500-430	B-430	Polyester	Clear	0.500 (12.7)	50 ft. (15.24 m)	1 roll (cont.)	M61-R6010
M611, BMP61, 71*, TLS	Fig. 33	PTL-8-430	B-430	Polyester	Clear	0.500 (12.7)	50 ft. (15.24 m)	1 roll (cont.)	M61-R6010
M611, BMP61	Fig. 2	M61-9-430	B-430	Polyester	Clear	0.650 (16.51)	0.200 (5.1)	750	M61-R6010
M611, BMP61	Fig. 2	M61-10-430	B-430	Polyester	Clear	0.750 (19.05)	0.250 (6.4)	750	M61-R6010
M611, BMP61, 71*, TLS	Fig. 2	PTL-16-430	B-430	Polyester	Clear	1.000 (25.4)	0.375 (9.5)	500	M61-R6010
M611, BMP61	Fig. 2	M61-98-430	B-430	Polyester	Clear	1.000 (25.4)	0.375 (9.5)	500	M61-R6010
M611, BMP61, 71*, TLS	Fig. 2	PTL-17-430	B-430	Polyester	Clear	1.000 (25.4)	0.500 (12.7)	500	M61-R6010
M611, BMP61	Fig. 2	M61-22-430	B-430	Polyester	Clear	1.000 (25.4)	1.000 (25.4)	100	M61-R6010
M611, BMP61	Fig. 2	M61-37-430	B-430	Polyester	Clear	1.000 (25.4)	3.000 (76.2)	100	M61-R6010
M611, BMP61, 71*, TLS	Fig. 33	PTL-42-430	B-430	Polyester	Clear	1.000 (25.4)	50 ft. (15.24 m)	1 roll (cont.)	M61-R6010
M611, BMP61	Fig. 2	M61-198-430	B-430	Polyester	Clear	1.250 (31.75)	2.750 (69.9)	100	M61-R6010
M611, BMP61, 71*, TLS	Fig. 2	PTL-28-430	B-430	Polyester	Clear	1.500 (38.1)	0.250 (6.4)	750	M61-R6010
M611, BMP61, 71*, TLS	Fig. 2	PTL-45-430	B-430	Polyester	Clear	1.500 (38.1)	0.375 (9.5)	500	M61-R6010
M611, BMP61, 71*, TLS	Fig. 2	PTL-29-430	B-430	Polyester	Clear	1.500 (38.1)	0.500 (12.7)	500	M61-R6010
M611, BMP61	Fig. 2	M61-30-430	B-430	Polyester	Clear	1.500 (38.1)	0.750 (19.05)	250	M61-R6010
M611, BMP61	Fig. 2	M61-52-430	B-430	Polyester	Clear	1.900 (48.26)	0.600 (15.2)	250	M61-R6010
M611, BMP61	Fig. 2	M61-78-430	B-430	Polyester	Clear	1.900 (48.26)	1.000 (25.4)	250	M61-R6010
M611, BMP61, 71*, TLS	Fig. 33	PTL-43-430	B-430	Polyester	Clear	1.900 (48.26)	50 ft. (15.24 m)	1 roll (cont.)	M61-R6010
M611, BMP61	Fig. 2	M61-61-430	B-430	Polyester	Clear	2.000 (50.8)	0.500 (12.7)	100	M61-R6010
B-483 Ultra-Aggressive Polyester									
M611, BMP61, 71*, TLS	Fig. 33	PTL-101-483	B-483	Polyester	White	0.250 (6.35)	50 ft. (15.24 m)	1 roll (cont.)	M61-R6010
M611, BMP61, 71*, TLS	Fig. 2	PTL-61-483	B-483	Polyester	White	0.500 (12.7)	2.000 (50.8)	100	M61-R6010
M611, BMP61, 71*, TLS	Fig. 33	PTL-8-483	B-483	Polyester	White	0.500 (12.7)	50 ft. (15.24 m)	1 roll (cont.)	M61-R6010
M611, BMP61, 71*, TLS	Fig. 2	PTL-62-483	B-483	Polyester	White	0.750 (19.05)	4.000 (101.6)	50	M61-R6010
M611, BMP61, 71*, TLS	Fig. 2	PTL-63-483	B-483	Polyester	White	0.750 (19.05)	8.000 (203.2)	50	M61-R6010
M611, BMP61, 71*, TLS	Fig. 2	PTL-16-483	B-483	Polyester	White	1.000 (25.4)	0.375 (9.5)	500	M61-R6010
M611, BMP61, 71*, TLS	Fig. 2	PTL-17-483	B-483	Polyester	White	1.000 (25.4)	0.500 (12.7)	500	M61-R6010
M611, BMP61, 71*, TLS	Fig. 2	PTL-19-483	B-483	Polyester	White	1.000 (25.4)	1.000 (25.4)	250	M61-R6010
M611, BMP61, 71*, TLS	Fig. 33	PTL-42-483	B-483	Polyester	White	1.000 (25.4)	50 ft. (15.24 m)	1 roll (cont.)	M61-R6010
M611, BMP61, 71*, TLS	Fig. 46	PTL-24-483-BK	B-483	Polyester	White	1.130 (28.7)	0.500 (12.7)	500	M61-R6010
M611, BMP61, 71*, TLS	Fig. 33	PTL-100-483	B-483	Polyester	White	1.300 (33.02)	50 ft. (15.24 m)	1 roll (cont.)	M61-R6010
M611, BMP61, 71*, TLS	Fig. 2	PTL-65-483	B-483	Polyester	White	1.375 (34.93)	1.000 (25.4)	250	M61-R6010
M611, BMP61, 71*, TLS	Fig. 2	PTL-29-483	B-483	Polyester	White	1.500 (38.1)	0.500 (12.7)	500	M61-R6010
M611, BMP61, 71*, TLS	Fig. 2	PTL-30-483	B-483	Polyester	White	1.500 (38.1)	0.750 (19.1)	250	M61-R6010
M611, BMP61, 71*, TLS	Fig. 2	PTL-31-483	B-483	Polyester	White	1.500 (38.1)	1.000 (25.4)	250	M61-R6010
M611, BMP61, 71*, TLS	Fig. 2	PTL-32-483	B-483	Polyester	White	1.500 (38.1)	1.500 (38.1)	250	M61-R6010
M611, BMP61, 71*, TLS	Fig. 33	PTL-43-483	B-483	Polyester	White	1.900 (48.26)	50 ft. (15.24 m)	1 roll (cont.)	M61-R6010
M611, BMP61, 71*, TLS	Fig. 2	PTL-20-483	B-483	Polyester	White	2.000 (50.8)	1.000 (25.4)	100	M61-R6010
M611, BMP61, 71*, TLS	Fig. 2	PTL-37-483	B-483	Polyester	White	1.900 (48.3)	3.000 (76.2)	100	M61-R6010
M611, BMP61, 71*, TLS	Fig. 72	PTL-37-483-WARNING	B-483	Polyester	White	1.900 (48.3)	3.000 (76.2)	100	M61-R6010
M611, BMP61, 71*, TLS	Fig. 2	PTL-23-483	B-483	Polyester	White	1.000 (25.4)	4.000 (101.6)	100	M61-R6010
M611, BMP61, 71*, TLS	Fig. 2	PTL-38-483	B-483	Polyester	White	1.900 (48.3)	4.000 (101.6)	100	M61-R6010
M611, BMP61, 71*, TLS	Fig. 72	PTL-38-483-WARNING	B-483	Polyester	White	1.900 (48.3)	4.000 (101.6)	100	M61-R6010
B-8459 Adhesive Polyester									
M611, BMP61	Fig. 2	M61-9-8459	B-8459	Polyester	White	0.650 (16.51)	0.200 (5.1)	750	M61-R6010
M611, BMP61	Fig. 2	M61-17-8459	B-8459	Polyester	White	1.000 (25.4)	0.500 (12.7)	500	M61-R6010
M611, BMP61	Fig. 2	M61-29-8459	B-8459	Polyester	White	1.500 (38.10)	0.500 (12.7)	500	M61-R6010
M611, BMP61	Fig. 2	M61-30-8459	B-8459	Polyester	White	1.500 (38.10)	0.750 (19.05)	250	M61-R6010
B-8591 Outdoor Polyester									
M611, BMP61	Fig. 2	M61-196-8591	B-8591	Polyester	White	1.180 (30.0)	1.970 (50.0)	100	M61-R6610
M611, BMP61	Fig. 33	M61C-1900-8591	B-8591	Polyester	White	1.900 (48.3)	50 ft. (15.24 m)	1 roll (cont.)	M61-R6610
M611, BMP61	Fig. 33	M61C-1000-8591	B-8591	Polyester	White	1.000 (25.4)	50 ft. (15.24 m)	1 roll (cont.)	M61-R6610

Portable Printers

M611 / BMP61

BradyPrinter M611 / BMP®61 Materials

BradyID.com/s36

Circuit Board Materials

Static Dissipative Labels (B-473, B-717, B-718 and B-719)

Low-profile polyimide and polyester materials that have static dissipative properties. Primarily used for circuit board and electronic components labeling.

- **B-473 Electrostatic Dissipative Polyester Material:** White glossy polyester with a permanent static dissipative adhesive and liner
- **B-717 Electrostatic Dissipative Polyimide Material:** High-temperature white glossy polyimide material (2 mil) with a permanent static dissipative adhesive and liner for PCB identification
- **B-718 Glossy Low Profile Electrostatic Dissipative Polyimide Material:** High-temperature, low-profile white glossy polyimide material (1 mil) with a permanent static dissipative adhesive and liner for PCB identification
- **B-719 Matte Low-Profile Electrostatic Dissipative Polyimide Material:** High-temperature, low-profile white matte polyimide material (1 mil) with a permanent static dissipative adhesive and liner

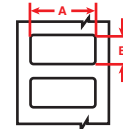

Figure 2

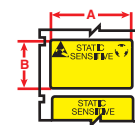

Figure 41

Fits Printers	Figure	Catalog #	B#	Material	Color	Label Width A Inch (mm)	Label Height B Inch (mm)	Labels Per Roll	Rec. Ribbon (M611 / BMP61)
B-473 Glossy White Electrostatic Dissipative Polyester									
M611, BMP61, 71*, TLS	Fig. 2	** PTL-1-473	B-473	Polyester	White	0.250 (6.35)	0.250 (6.4)	750	M61-R6010
M611, BMP61, 71*, TLS	Fig. 2	** PTL-5-473	B-473	Polyester	White	0.500 (12.7)	0.200 (5.1)	750	M61-R6010
M611, BMP61, 71*, TLS	Fig. 2	** PTL-6-473	B-473	Polyester	White	0.500 (12.7)	0.275 (7)	750	M61-R6010
M611, BMP61, 71*, TLS	Fig. 2	** PTL-9-473	B-473	Polyester	White	0.650 (16.51)	0.200 (5.1)	750	M61-R6010
M611, BMP61, 71*, TLS	Fig. 2	** PTL-10-473	B-473	Polyester	White	0.750 (19.05)	0.250 (6.4)	750	M61-R6010
M611, BMP61, 71*, TLS	Fig. 2	** PTL-16-473	B-473	Polyester	White	1.000 (25.4)	0.375 (9.5)	500	M61-R6010
M611, BMP61, 71*, TLS	Fig. 41	** PTL-17-473	B-473	Polyester	Black on Yellow	1.000 (25.4)	0.500 (12.7)	500	M61-R6010
M611, BMP61, 71*, TLS	Fig. 2	** PTL-17-473	B-473	Polyester	White	1.000 (25.4)	0.500 (12.7)	500	M61-R6010
M611, BMP61, 71*, TLS	Fig. 2	** PTL-28-473	B-473	Polyester	White	1.500 (38.1)	0.250 (6.4)	750	M61-R6010
B-717 Glossy White Static Dissipative Polyimide									
M611, BMP61, 71*, TLS	Fig. 2	** PTL-10-717	B-717	Polyimide	White	0.250 (6.35)	0.750 (19.1)	750	M61-R6010
M611, BMP61, 71*, TLS	Fig. 2	** PTL-3-717	B-717	Polyimide	White	0.375 (9.53)	0.375 (9.53)	500	M61-R6010
M611, BMP61, 71*, TLS	Fig. 2	** PTL-1-717	B-717	Polyimide	White	0.375 (9.53)	1.000 (25.4)	750	M61-R6010
M611, BMP61, 71*, TLS	Fig. 2	** PTL-9-717	B-717	Polyimide	White	0.650 (16.51)	0.200 (5.1)	750	M61-R6010
M611, BMP61, 71*, TLS	Fig. 2	** PTL-25-717	B-717	Polyimide	White	1.250 (31.75)	0.250 (6.4)	750	M61-R6010
M611, BMP61, 71*, TLS	Fig. 2	** PTL-27-717	B-717	Polyimide	White	1.500 (38.1)	0.125 (3.2)	750	M61-R6010
M611, BMP61, 71*, TLS	Fig. 2	** PTL-28-717	B-717	Polyimide	White	1.500 (38.1)	0.250 (6.4)	750	M61-R6010
M611, BMP61, 71*, TLS	Fig. 2	** PTL-14-717	B-717	Polyimide	White	2.000 (50.8)	0.187 (4.7)	750	M61-R6010
M611, BMP61, 71*, TLS	Fig. 2	** PTL-2-717	B-717	Polyimide	White	2.000 (50.8)	0.250 (6.35)	100	M61-R6010
B-718 Glossy White Low-Profile Static Dissipative Polyimide									
M611, BMP61, 71*, TLS	Fig. 2	** PTL-14-718	B-718	Polyimide	White	0.187 (4.7)	3.000 (76.2)	750	M61-R6010
M611, BMP61, 71*, TLS	Fig. 2	** PTL-10-718	B-718	Polyimide	White	0.250 (6.35)	0.750 (19.1)	750	M61-R6010
M611, BMP61, 71*, TLS	Fig. 2	** PTL-3-718	B-718	Polyimide	White	0.375 (9.53)	0.375 (9.53)	500	M61-R6010
M611, BMP61, 71*, TLS	Fig. 2	** PTL-1-718	B-718	Polyimide	White	0.375 (9.53)	1.000 (25.4)	750	M61-R6010
M611, BMP61, 71*, TLS	Fig. 2	** PTL-16-718	B-718	Polyimide	White	0.375 (9.53)	1.000 (25.4)	500	M61-R6010
M611, BMP61, 71*, TLS	Fig. 2	** PTL-4-718	B-718	Polyimide	White	0.400 (10.2)	0.400 (10.2)	500	M61-R6010
M611, BMP61, 71*, TLS	Fig. 2	** PTL-6-718	B-718	Polyimide	White	0.500 (12.7)	0.275 (6.98)	750	M61-R6010
M611, BMP61, 71*, TLS	Fig. 2	** PTL-9-718	B-718	Polyimide	White	0.650 (16.51)	0.200 (5.1)	750	M61-R6010
M611, BMP61, 71*, TLS	Fig. 2	** PTL-13-718	B-718	Polyimide	White	0.900 (22.86)	0.250 (6.4)	750	M61-R6010
M611, BMP61, 71*, TLS	Fig. 2	** PTL-28-718	B-718	Polyimide	White	1.500 (38.1)	0.250 (6.4)	750	M61-R6010
B-719 Matte White Low-Profile Static Dissipative Polyimide									
M611, BMP61, 71*, TLS	Fig. 2	** PTL-10-719	B-719	Polyimide	White	0.250 (6.35)	0.750 (19.1)	750	M61-R6010
M611, BMP61, 71*, TLS	Fig. 2	** PTL-16-719	B-719	Polyimide	White	0.375 (9.53)	1.000 (25.4)	500	M61-R6010
M611, BMP61, 71*, TLS	Fig. 2	** PTL-4-719	B-719	Polyimide	White	0.400 (10.2)	0.400 (10.2)	500	M61-R6010
M611, BMP61, 71*, TLS	Fig. 2	** PTL-6-719	B-719	Polyimide	White	0.500 (12.7)	0.275 (6.98)	750	M61-R6010
M611, BMP61, 71*, TLS	Fig. 2	** PTL-17-719	B-719	Polyimide	White	0.500 (12.7)	3.000 (76.2)	500	M61-R6010
M611, BMP61, 71*, TLS	Fig. 2	** PTL-9-719	B-719	Polyimide	White	0.650 (16.51)	0.200 (5.1)	750	M61-R6010
M611, BMP61, 71*, TLS	Fig. 2	** PTL-13-719	B-719	Polyimide	White	0.900 (22.86)	0.250 (6.4)	750	M61-R6010
M611, BMP61, 71*, TLS	Fig. 2	** PTL-28-719	B-719	Polyimide	White	1.500 (38.1)	0.250 (6.4)	750	M61-R6010

** ⚠️ **WARNING:** Cancer www.P65Warnings.ca.gov

Circuit Board Materials

High-Temperature Polyimide Labels (B-724 and B-727)

Low-profile polyimide and polyester materials that have static dissipative properties. Primarily used for circuit board and electronic component labeling.

- **B-724 Amber Polyimide Material:** Matte polyimide with permanent adhesive; can survive on the top or bottom side of PCBs through the solder process
- **B-727 White Polyimide Material:** Glossy polyimide with permanent adhesive; withstands wave solder environments for printed circuit board and electronic component preprocess labeling

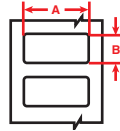

Figure 2



Fits Printers	Figure	Catalog #	B#	Material	Color	Label Width A Inch (mm)	Label Height B Inch (mm)	Labels Per Roll	Rec. Ribbon (M611 / BMP61)
B-724 Matte Polyimide Material									
M611, BMP61, 71*, TLS	Fig. 2	PTL-10-724	B-724	Polyimide	Amber	0.250 (6.35)	0.750 (19.1)	750	M61-R4310
M611, BMP61, 71*, TLS	Fig. 2	PTL-3-724	B-724	Polyimide	Amber	0.375 (9.53)	0.375 (9.53)	500	M61-R4310
M611, BMP61, 71*, TLS	Fig. 2	PTL-1-724	B-724	Polyimide	Amber	0.375 (9.53)	1.000 (25.4)	750	M61-R4310
M611, BMP61, 71*, TLS	Fig. 2	PTL-16-724	B-724	Polyimide	Amber	0.375 (9.53)	1.000 (25.4)	500	M61-R4310
M611, BMP61, 71*, TLS	Fig. 2	PTL-4-724	B-724	Polyimide	Amber	0.400 (10.2)	0.400 (10.2)	500	M61-R4310
M611, BMP61, 71*, TLS	Fig. 2	PTL-6-724	B-724	Polyimide	Amber	0.500 (12.7)	0.275 (6.98)	750	M61-R4310
M611, BMP61, 71*, TLS	Fig. 2	PTL-17-724	B-724	Polyimide	Amber	0.500 (12.7)	4.000 (101.6)	500	M61-R4310
M611, BMP61, 71*, TLS	Fig. 2	PTL-9-724	B-724	Polyimide	Amber	0.650 (16.51)	0.200 (5.1)	750	M61-R4310
M611, BMP61, 71*, TLS	Fig. 2	PTL-13-724	B-724	Polyimide	Amber	0.900 (22.86)	0.250 (6.4)	750	M61-R4310
M611, BMP61, 71*, TLS	Fig. 2	PTL-25-724	B-724	Polyimide	Amber	1.250 (31.75)	0.250 (6.4)	750	M61-R4310
M611, BMP61, 71*, TLS	Fig. 2	PTL-27-724	B-724	Polyimide	Amber	1.500 (38.1)	0.125 (3.2)	750	M61-R4310
M611, BMP61, 71*, TLS	Fig. 2	PTL-28-724	B-724	Polyimide	Amber	1.500 (38.1)	0.250 (6.4)	750	M61-R4310
M611, BMP61, 71*, TLS	Fig. 2	PTL-2-724	B-724	Polyimide	Amber	2.000 (50.8)	0.250 (6.35)	100	M61-R4310
B-727 Glossy Polyimide Material									
M611, BMP61, 71*, TLS	Fig. 2	PTL-14-727	B-727	Polyimide	White	0.187 (4.7)	4.000 (101.6)	750	M61-R6010
M611, BMP61, 71*, TLS	Fig. 2	PTL-10-727	B-727	Polyimide	White	0.250 (6.35)	0.750 (19.1)	750	M61-R6010
M611, BMP61, 71*, TLS	Fig. 2	PTL-3-727	B-727	Polyimide	White	0.375 (9.53)	0.375 (9.53)	500	M61-R6010
M611, BMP61, 71*, TLS	Fig. 2	PTL-1-727	B-727	Polyimide	White	0.375 (9.53)	1.000 (25.4)	750	M61-R6010
M611, BMP61, 71*, TLS	Fig. 2	PTL-16-727	B-727	Polyimide	White	0.375 (9.53)	1.000 (25.4)	500	M61-R6010
M611, BMP61, 71*, TLS	Fig. 2	PTL-4-727	B-727	Polyimide	White	0.400 (10.2)	0.400 (10.2)	500	M61-R6010
M611, BMP61, 71*, TLS	Fig. 2	PTL-6-727	B-727	Polyimide	White	0.500 (12.7)	0.275 (6.98)	750	M61-R6010
M611, BMP61, 71*, TLS	Fig. 2	PTL-9-727	B-727	Polyimide	White	0.650 (16.51)	0.200 (5.1)	750	M61-R6010
M611, BMP61, 71*, TLS	Fig. 2	PTL-13-727	B-727	Polyimide	White	0.900 (22.86)	0.250 (6.4)	750	M61-R6010
M611, BMP61, 71*, TLS	Fig. 2	PTL-28-727	B-727	Polyimide	White	1.500 (38.1)	0.250 (6.4)	750	M61-R6010
M611, BMP61, 71*, TLS	Fig. 2	PTL-2-727	B-727	Polyimide	White	2.000 (50.8)	0.250 (6.35)	100	M61-R6010

Bulk parts for high volume printing

Bulk label parts offer a cost-effective solution for high volume printing with the BMP®61 printer. Look for material catalog numbers that begin with "BM71-" or "BPTL".

**Bulk label printing requires the media feeder and smart cell spool which are included in the bulk material packaging.*



BradyPrinter M611 / BMP®61 Materials

BradyID.com/s36

General ID Materials

General ID Polyester Labels (B-432, B-459, B-488 and B-489)

- **B-432 Clear Polyester Material:** High-performance glossy polyester, good adherence for rough surface applications.
- **B-459 Permanent Polyester Material:** White matte polyester with permanent adhesive
- **B-488 Ultra-Aggressive Polyester Material:** White matte polyester with an aggressive adhesive
- **B-489 Ultra-Aggressive Polyester Material:** White matte polyester with an aggressive adhesive

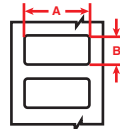

Figure 2

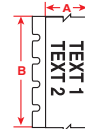
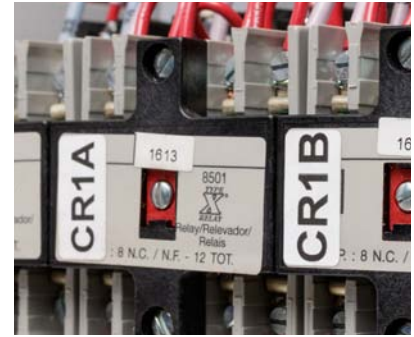

Figure 3



Portable Printers

M611 / BMP61

Fits Printers	Figure	Catalog #	B#	Material	Color	Label Width A Inch (mm)	Label Height B Inch (mm)	Labels Per Roll	Rec. Ribbon (M611 / BMP61)
B-432 Clear Polyester									
M611, BMP61, 71*, TLS	Fig. 33	PTL-101-432	B-432	Polyester	Clear	0.250 (6.35)	50 ft. (15.24 m)	1 roll (cont.)	M61-R6010
M611, BMP61, 71*, TLS	Fig. 2	PTL-11-432	B-432	Polyester	Clear	0.500 (12.7)	0.750 (19.1)	500	M61-R6010
M611, BMP61, 71*, TLS	Fig. 33	PTL-8-432	B-432	Polyester	Clear	0.500 (12.7)	50 ft. (15.24 m)	1 roll (cont.)	M61-R6010
M611, BMP61, 71*, TLS	Fig. 2	PTL-10-432	B-432	Polyester	Clear	0.750 (19.05)	0.250 (6.4)	750	M61-R6010
M611, BMP61, 71*, TLS	Fig. 2	PTL-17-432	B-432	Polyester	Clear	1.000 (25.4)	0.500 (12.7)	500	M61-R6010
M611, BMP61, 71*, TLS	Fig. 33	PTL-42-432	B-432	Polyester	Clear	1.000 (25.4)	50 ft. (15.24 m)	1 roll (cont.)	M61-R6010
M611, BMP61, 71*, TLS	Fig. 33	PTL-43-432	B-432	Polyester	Clear	1.900 (48.26)	50 ft. (15.24 m)	1 roll (cont.)	M61-R6010
B-459 Permanent Polyester									
M611, BMP61, 71*, TLS	Fig. 2	PTL-29-459	B-459	Polyester	White	1.500 (38.1)	0.500 (12.7)	500	M61-R4310
M611, BMP61, 71*, TLS	Fig. 2	PTL-30-459	B-459	Polyester	White	1.500 (38.1)	0.750 (19.1)	250	M61-R4310
M611, BMP61, 71*, TLS	Fig. 2	PTL-20-459	B-459	Polyester	White	2.000 (50.8)	1.000 (25.4)	100	M61-R4310
B-488 Ultra-Aggressive Polyester									
M611, BMP61, 71*, TLS	Fig. 2	PTL-80-488	B-488	Polyester	White	0.750 (19.05)	0.900 (22.9)	250	M61-R4310
M611, BMP61, 71*, TLS	Fig. 2	PTL-97-488	B-488	Polyester	White	0.900 (22.86)	0.900 (22.9)	250	M61-R4310
M611, BMP61, 71*, TLS	Fig. 2	PTL-81-488	B-488	Polyester	White	1.900 (48.26)	0.250 (6.4)	750	M61-R4310
M611, BMP61, 71*, TLS	Fig. 2	PTL-78-488	B-488	Polyester	White	1.900 (48.26)	1.000 (25.4)	250	M61-R4310
B-489 Ultra-Aggressive Polyester									
M611, BMP61, 71*, TLS	Fig. 33	PTL-101-489	B-489	Polyester	White	0.250 (6.35)	50 ft. (15.24 m)	1 roll (cont.)	M61-R4310
M611, BMP61, 71*, TLS	Fig. 33	PTL-8-489	B-489	Polyester	White	0.500 (12.7)	50 ft. (15.24 m)	1 roll (cont.)	M61-R4310
M611, BMP61, 71*, TLS	Fig. 2	PTL-16-489	B-489	Polyester	White	1.000 (25.4)	0.375 (9.5)	500	M61-R4310
M611, BMP61, 71*, TLS	Fig. 2	PTL-17-489	B-489	Polyester	White	1.000 (25.4)	0.500 (12.7)	500	M61-R4310
M611, BMP61, 71*, TLS	Fig. 2	PTL-19-489	B-489	Polyester	White	1.000 (25.4)	1.000 (25.4)	250	M61-R4310
M611, BMP61, 71*, TLS	Fig. 33	PTL-42-489	B-489	Polyester	White	1.000 (25.4)	50 ft. (15.24 m)	1 roll (cont.)	M61-R4310
M611, BMP61, 71*, TLS	Fig. 33	PTL-100-489	B-489	Polyester	White	1.300 (33.02)	50 ft. (15.24 m)	1 roll (cont.)	M61-R4310
M611, BMP61, 71*, TLS	Fig. 2	PTL-29-489	B-489	Polyester	White	1.500 (38.1)	0.500 (12.7)	500	M61-R4310
M611, BMP61, 71*, TLS	Fig. 2	PTL-30-489	B-489	Polyester	White	1.500 (38.1)	0.750 (19.1)	250	M61-R4310
M611, BMP61, 71*, TLS	Fig. 2	PTL-31-489	B-489	Polyester	White	1.500 (38.1)	1.000 (25.4)	250	M61-R4310
M611, BMP61, 71*, TLS	Fig. 2	PTL-32-489	B-489	Polyester	White	1.500 (38.1)	1.500 (38.1)	250	M61-R4310
M611, BMP61, 71*, TLS	Fig. 2	PTL-37-489	B-489	Polyester	White	1.900 (48.26)	3.000 (76.2)	100	M61-R4310
M611, BMP61, 71*, TLS	Fig. 2	PTL-38-489	B-489	Polyester	White	1.900 (48.26)	4.000 (101.6)	100	M61-R4310
M611, BMP61, 71*, TLS	Fig. 33	PTL-43-489	B-489	Polyester	White	1.900 (48.26)	50 ft. (15.24 m)	1 roll (cont.)	M61-R4310
M611, BMP61, 71*, TLS	Fig. 2	PTL-20-489	B-489	Polyester	White	2.000 (50.8)	1.000 (25.4)	100	M61-R4310

Paper Labels (B-424)

White paper material with matte finish. Good contrast and smear resistance for thermal barcode printing. Used for general purpose labeling applications.

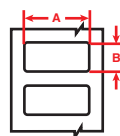

Figure 2

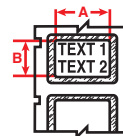

Figure 40
w/ overlaminate



Fits Printers	Figure	Catalog #	B#	Material	Color	Label Width A Inch (mm)	Label Height B Inch (mm)	Labels Per Roll	Rec. Ribbon (M611 / BMP61)
M611, BMP61, 71*, TLS	Fig. 2	PTL-80-424	B-424	Paper	White	0.750 (19.05)	0.900 (22.9)	250	M61-R4310
M611, BMP61, 71*, TLS	Fig. 40	PTPSL-17-424	B-424	Paper	White	1.000 (25.4)	0.500 (12.7)	500	M61-R4310
M611, BMP61, 71*, TLS	Fig. 2	PTL-22-424	B-424	Paper	White	1.000 (25.4)	3.000 (76.2)	100	M61-R4310
M611, BMP61, 71*, TLS	Fig. 2	PTL-37-424	B-424	Paper	White	1.900 (48.3)	3.000 (76.2)	100	M61-R4310
M611, BMP61, 71*, TLS	Fig. 2	PTL-38-424	B-424	Paper	White	1.900 (48.3)	4.000 (101.6)	100	M61-R4310
M611, BMP61, 71*, TLS	Fig. 2	PTL-20-424	B-424	Paper	White	2.000 (50.8)	1.000 (25.4)	100	M61-R4310
M611, BMP61, 71*, TLS	Fig. 40	PTPSL-20-424	B-424	Paper	White	2.000 (50.8)	1.000 (25.4)	100	M61-R4310

General ID Materials

General ID Vinyl Labels (B-439 and B-595)

Ideal for applications needing various colors such as lean / 5S, pipe markers, equipment and production area identification.

- **B-439 Vinyl:** Designed for use in ambient conditions with limited solvent exposure
- **B-595 Indoor / Outdoor Vinyl:** High-performance vinyl with permanent adhesive is very pliable and good for rough surfaces and outdoor use. 8-10 years average outdoor durability* Temp. range: -40° F to 180° F (-40° C to 82° C). UL recognized.

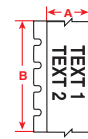

Figure 33



Fits Printers	Figure	Catalog #	B#	Material	Color	Label Width A Inch (mm)	Roll Length B Feet (m)	Labels Per Roll	Rec. Ribbon (M611 / BMP61)
B-439 Vinyl									
M611, BMP61, 71*, TLS	Fig. 33	M61C-250-439	B-439	Vinyl	White	0.250 (6.35)	50 (15.24)	1 roll (cont.)	M61-R6010
M611, BMP61	Fig. 33	M61C-375-439	B-439	Vinyl	White	0.375 (9.52)	50 (15.24)	1 roll (cont.)	M61-R6010
M611, BMP61, 71*, TLS	Fig. 33	PTL-8-439	B-439	Vinyl	White	0.500 (12.7)	50 (15.24)	1 roll (cont.)	M61-R6010
M611, BMP61, 71*, TLS	Fig. 33	PTL-42-439	B-439	Vinyl	White	1.000 (25.4)	50 (15.24)	1 roll (cont.)	M61-R6010
M611, BMP61, 71*, TLS	Fig. 33	PTL-43-439	B-439	Vinyl	White	1.900 (48.26)	50 (15.24)	1 roll (cont.)	M61-R6010
M611, BMP61, 71*, TLS	Fig. 33	M61C-250-439-YL	B-439	Vinyl	Yellow	0.250 (6.35)	50 (15.24)	1 roll (cont.)	M61-R6010
M611, BMP61	Fig. 33	M61C-375-439-YL	B-439	Vinyl	Yellow	0.375 (9.52)	50 (15.24)	1 roll (cont.)	M61-R6010
M611, BMP61, 71*, TLS	Fig. 33	PTL-8-439-YL	B-439	Vinyl	Yellow	0.500 (12.7)	50 (15.24)	1 roll (cont.)	M61-R6010
M611, BMP61, 71*, TLS	Fig. 33	PTL-42-439-YL	B-439	Vinyl	Yellow	1.000 (25.4)	50 (15.24)	1 roll (cont.)	M61-R6010
M611, BMP61, 71*, TLS	Fig. 33	PTL-43-439-YL	B-439	Vinyl	Yellow	1.900 (48.26)	50 (15.24)	1 roll (cont.)	M61-R6010
M611, BMP61, 71*, TLS	Fig. 33	PTL-8-439-OR	B-439	Vinyl	Orange	0.500 (12.7)	50 (15.24)	1 roll (cont.)	M61-R6010
M611, BMP61, 71*, TLS	Fig. 33	PTL-42-439-OR	B-439	Vinyl	Orange	1.000 (25.4)	50 (15.24)	1 roll (cont.)	M61-R6010
M611, BMP61, 71*, TLS	Fig. 33	PTL-43-439-OR	B-439	Vinyl	Orange	1.900 (48.26)	50 (15.24)	1 roll (cont.)	M61-R6010
M611, BMP61, 71*, TLS	Fig. 33	PTL-8-439-RD	B-439	Vinyl	Red	0.500 (12.7)	50 (15.24)	1 roll (cont.)	M61-R4410-WT
M611, BMP61, 71*, TLS	Fig. 33	PTL-42-439-RD	B-439	Vinyl	Red	1.000 (25.4)	50 (15.24)	1 roll (cont.)	M61-R4410-WT
M611, BMP61, 71*, TLS	Fig. 33	PTL-43-439-RD	B-439	Vinyl	Red	1.900 (48.26)	50 (15.24)	1 roll (cont.)	M61-R4410-WT
M611, BMP61, 71*, TLS	Fig. 33	PTL-8-439-BL	B-439	Vinyl	Blue	0.500 (12.7)	50 (15.24)	1 roll (cont.)	M61-R4410-WT
M611, BMP61, 71*, TLS	Fig. 33	PTL-42-439-BL	B-439	Vinyl	Blue	1.000 (25.4)	50 (15.24)	1 roll (cont.)	M61-R4410-WT
M611, BMP61, 71*, TLS	Fig. 33	PTL-43-439-BL	B-439	Vinyl	Blue	1.900 (48.26)	50 (15.24)	1 roll (cont.)	M61-R4410-WT
M611, BMP61, 71*, TLS	Fig. 33	PTL-8-439-GR	B-439	Vinyl	Green	0.500 (12.7)	50 (15.24)	1 roll (cont.)	M61-R4410-WT
M611, BMP61, 71*, TLS	Fig. 33	PTL-42-439-GR	B-439	Vinyl	Green	1.000 (25.4)	50 (15.24)	1 roll (cont.)	M61-R4410-WT
M611, BMP61, 71*, TLS	Fig. 33	PTL-43-439-GR	B-439	Vinyl	Green	1.900 (48.26)	50 (15.24)	1 roll (cont.)	M61-R4410-WT
M611, BMP61, 71*, TLS	Fig. 33	PTL-8-439-BK	B-439	Vinyl	Black	0.500 (12.7)	50 (15.24)	1 roll (cont.)	M61-R4410-WT
M611, BMP61, 71*, TLS	Fig. 33	PTL-42-439-BK	B-439	Vinyl	Black	1.000 (25.4)	50 (15.24)	1 roll (cont.)	M61-R4410-WT
M611, BMP61, 71*, TLS	Fig. 33	PTL-43-439-BK	B-439	Vinyl	Black	1.900 (48.26)	50 (15.24)	1 roll (cont.)	M61-R4410-WT
B-595 Indoor / Outdoor Vinyl									
M611, BMP61	Fig. 33	M61C-500-595-WT	B-595	Vinyl	White	0.500 (12.7)	50 (15.24)	1 roll (cont.)	M61-R6010
M611, BMP61	Fig. 33	M61C-1000-595-WT	B-595	Vinyl	White	1.000 (25.4)	50 (15.24)	1 roll (cont.)	M61-R6010
M611, BMP61	Fig. 33	M61C-2000-595-WT	B-595	Vinyl	White	2.000 (50.8)	50 (15.24)	1 roll (cont.)	M61-R6010
M611, BMP61	Fig. 33	M61C-500-595-CL	B-595	Vinyl	Clear	0.500 (12.7)	50 (15.24)	1 roll (cont.)	M61-R6010
M611, BMP61	Fig. 33	M61C-1000-595-CL	B-595	Vinyl	Clear	1.000 (25.4)	50 (15.24)	1 roll (cont.)	M61-R6010
M611, BMP61	Fig. 33	M61C-2000-595-CL	B-595	Vinyl	Clear	2.000 (50.8)	50 (15.24)	1 roll (cont.)	M61-R6010
M611, BMP61	Fig. 33	M61C-500-595-YL	B-595	Vinyl	Yellow	0.500 (12.7)	50 (15.24)	1 roll (cont.)	M61-R6010
M611, BMP61	Fig. 33	M61C-1000-595-YL	B-595	Vinyl	Yellow	1.000 (25.4)	50 (15.24)	1 roll (cont.)	M61-R6010
M611, BMP61	Fig. 33	M61C-2000-595-YL	B-595	Vinyl	Yellow	2.000 (50.8)	50 (15.24)	1 roll (cont.)	M61-R6010
M611, BMP61	Fig. 33	M61C-500-595-RD	B-595	Vinyl	Red	0.500 (12.7)	50 (15.24)	1 roll (cont.)	M61-R6010
M611, BMP61	Fig. 33	M61C-1000-595-RD	B-595	Vinyl	Red	1.000 (25.4)	50 (15.24)	1 roll (cont.)	M61-R6010
M611, BMP61	Fig. 33	M61C-2000-595-RD	B-595	Vinyl	Red	2.000 (50.8)	50 (15.24)	1 roll (cont.)	M61-R6010
M611, BMP61	Fig. 33	M61C-500-595-OR	B-595	Vinyl	Orange	0.500 (12.7)	50 (15.24)	1 roll (cont.)	M61-R6010
M611, BMP61	Fig. 33	M61C-1000-595-OR	B-595	Vinyl	Orange	1.000 (25.4)	50 (15.24)	1 roll (cont.)	M61-R6010
M611, BMP61	Fig. 33	M61C-2000-595-OR	B-595	Vinyl	Orange	2.000 (50.8)	50 (15.24)	1 roll (cont.)	M61-R6010
M611, BMP61	Fig. 33	M61C-500-595-GN	B-595	Vinyl	Green	0.500 (12.7)	50 (15.24)	1 roll (cont.)	M61-R6010
M611, BMP61	Fig. 33	M61C-1000-595-GN	B-595	Vinyl	Green	1.000 (25.4)	50 (15.24)	1 roll (cont.)	M61-R6010
M611, BMP61	Fig. 33	M61C-2000-595-GN	B-595	Vinyl	Green	2.000 (50.8)	50 (15.24)	1 roll (cont.)	M61-R6010
M611, BMP61	Fig. 33	M61C-500-595-BL	B-595	Vinyl	Blue	0.500 (12.7)	50 (15.24)	1 roll (cont.)	M61-R6010
M611, BMP61	Fig. 33	M61C-1000-595-BL	B-595	Vinyl	Blue	1.000 (25.4)	50 (15.24)	1 roll (cont.)	M61-R6010
M611, BMP61	Fig. 33	M61C-2000-595-BL	B-595	Vinyl	Blue	2.000 (50.8)	50 (15.24)	1 roll (cont.)	M61-R6010
M611, BMP61	Fig. 33	M61C-500-595-BK	B-595	Vinyl	Black	0.500 (12.7)	50 (15.24)	1 roll (cont.)	M61-R6010
M611, BMP61	Fig. 33	M61C-1000-595-BK	B-595	Vinyl	Black	1.000 (25.4)	50 (15.24)	1 roll (cont.)	M61-R6010
M611, BMP61	Fig. 33	M61C-2000-595-BK	B-595	Vinyl	Black	2.000 (50.8)	50 (15.24)	1 roll (cont.)	M61-R6010
M611, BMP61	Fig. 33	M61C-2000-595-LB	B-595	Vinyl	Light Blue	2.000 (50.8)	50 (15.24)	1 roll (cont.)	M61-R6010
M611, BMP61	Fig. 33	M61C-1000-595-GY	B-595	Vinyl	Gray	1.000 (25.4)	50 (15.24)	1 roll (cont.)	M61-R6010
M611, BMP61	Fig. 33	M61C-2000-595-GD	B-595	Vinyl	Gold	2.000 (50.8)	50 (15.24)	1 roll (cont.)	M61-R6010
M611, BMP61	Fig. 33	M61C-2000-595-BR	B-595	Vinyl	Brown	2.000 (50.8)	50 (15.24)	1 roll (cont.)	M61-R6010
M611, BMP61	Fig. 33	M61C-2000-595-PL	B-595	Vinyl	Purple	2.000 (50.8)	50 (15.24)	1 roll (cont.)	M61-R6010

* Average expected outdoor life of product will depend on user definition of failure, climatic conditions, mounting techniques and material color. The 8-10 year outdoor durability applies to the label stock only; ribbon durability will vary. Refer to the Technical Data Sheet at BradyID.com for performance characteristics.

BradyPrinter M611 / BMP®61 Materials

BradyID.com/s36

General ID Materials

Reflective Material (B-584)

Reflective material shines back brightly when struck by light, making it ideal for labeling outdoor utility poles, hard hats, jobsite equipment and roof-top equipment. Meets Federal Spec L-S-300 for reflectivity. Average outdoor durability is 4-6 years.* Temp. range: -40° F to 158° F (-40° C to 70° C).

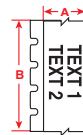

Figure 33



Fits Printers	Figure	Catalog #	B#	Material	Color	Label Width A Inch (mm)	Roll Length Feet (m)	Labels Per Roll	Rec. Ribbon (M611 / BMP61)
M611, BMP61	Fig. 33	M61C-1000-584-OR	B-584	Reflective	Orange	1.000 (25.4)	30 (9.14)	1 roll (cont.)	M61-R6010
M611, BMP61	Fig. 33	M61C-2000-584-OR	B-584	Reflective	Orange	2.000 (50.8)	30 (9.14)	1 roll (cont.)	M61-R6010
M611, BMP61	Fig. 33	M61C-2000-584-YL	B-584	Reflective	Yellow	2.000 (50.8)	30 (9.14)	1 roll (cont.)	M61-R6010
M611, BMP61	Fig. 33	M61C-2000-584-SL	B-584	Reflective	Silver	2.000 (50.8)	30 (9.14)	1 roll (cont.)	M61-R6010

* Outdoor durability applies to the label stock only; ribbon durability will vary. Refer to the Technical Data Sheet at BradyID.com for performance characteristics.

Tamper-Indicating Labels (B-351, B-7546 and B-7576)

- B-351 Destructible Vinyl Material:**
 Destructible vinyl material prohibits one piece removal of label to indicate if the label has been tampered with
- B-7546 VOID Footprint Polyester Material:**
 Glossy white polyester leaves a "VOID" footprint when the label is removed to prevent it from being reused
- B-7576 Metallized VOID Polyester Material:**
 Matte white polyester leaves a "VOID" footprint when the label is removed. A "VOID" pattern will appear on the top surface of the label to prevent reuse

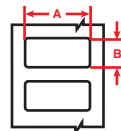

Figure 2



Fits Printers	Figure	Catalog #	B#	Material	Color	Label Width A Inch (mm)	Label Height B Inch (mm)	Labels Per Roll	Rec. Ribbon (M611 / BMP61)
B-351 Destructible Vinyl									
M611, BMP61, 71*, TLS	Fig. 2	PTL-17-351	B-351	Vinyl	White	1.000 (25.4)	0.500 (12.7)	500	M61-R6210
M611, BMP61, 71*, TLS	Fig. 2	PTL-20-351	B-351	Vinyl	White	1.000 (25.4)	2.000 (50.8)	100	M61-R6210
M611, BMP61, 71*, TLS	Fig. 2	PTL-31-351	B-351	Vinyl	White	1.500 (38.1)	1.000 (25.4)	250	M61-R6210
M611, BMP61, 71*, TLS	Fig. 2	PTL-37-351	B-351	Vinyl	White	1.900 (48.3)	3.000 (76.2)	100	M61-R6210
B-7546 VOID Footprint Polyester									
M611, BMP61, 71*, TLS	Fig. 2	PTL-17-7546	B-7546	Polyester	White	1.000 (25.4)	0.500 (12.7)	500	M61-R6010
M611, BMP61, 71*, TLS	Fig. 2	PTL-31-7546	B-7546	Polyester	White	1.500 (38.1)	1.000 (25.4)	250	M61-R6010
M611, BMP61, 71*, TLS	Fig. 2	PTL-20-7546	B-7546	Polyester	White	2.000 (50.8)	1.000 (25.4)	100	M61-R6010
B-7576 Metallized VOID Polyester									
M611, BMP61, 71*, TLS	Fig. 2	PTL-20-7576	B-7576	Polyester	Silver	1.000 (25.4)	2.000 (50.8)	100	M61-R6010
M611, BMP61, 71*, TLS	Fig. 2	PTL-31-7576	B-7576	Polyester	Silver	1.500 (38.1)	1.000 (25.4)	250	M61-R6010
M611, BMP61, 71*, TLS	Fig. 2	PTL-37-7576	B-7576	Polyester	Silver	1.900 (48.3)	3.000 (76.2)	100	M61-R6010

Water-Dissolvable Paper Labels (B-403)

Labels completely dissolve in warm water within 30 seconds, leaving no adhesive residue, eliminating labor required for label removal and allows for easy re-identification.

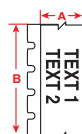
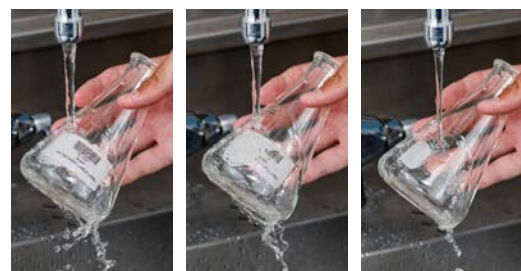

Figure 33



Fits Printers	Figure	Catalog #	B#	Material	Color	Label Width A Inch (mm)	Label Height B Inch (mm)	Labels Per Roll	Rec. Ribbon (M611 / BMP61)
M611, BMP61	Fig. 33	M61C-750-403	B-403	Paper	White	0.750 (19.05)	50 (15.24)	1 roll (cont.)	M61-R4310
M611, BMP61	Fig. 33	M61C-1500-403	B-403	Paper	White	1.500 (38.1)	50 (15.24)	1 roll (cont.)	M61-R4310

Portable Printers

M611 / BMP61

Laboratory Materials

Color Polyester Labels (B-494)

Glossy white polyester with a color border printed on the label allows for differentiation of test specimens within user processes. Vial top labels are solid color. Material is resistant to common lab chemicals such as ethanol and xylene.

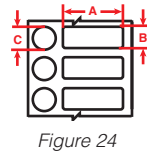
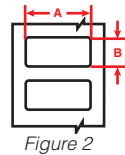

Fits Printers	Figure	Catalog #	B#	Material	Color	Label Width A Inch (mm)	Label Height B Inch (mm)	Secondary Label Inch (mm)	Labels Per Roll	Rec. Ribbon (M611 / BMP61)
M611, BMP61	Fig. 24	M61-98-494-BL	B-494	Polyester	Blue	1.000 (25.4)	0.375 (9.5)	0.375 (9.5) dia.	500	M61-R6410
M611, BMP61	Fig. 2	M61-17-494-BL	B-494	Polyester	Blue	1.000 (25.4)	0.500 (12.7)	-	500	M61-R6410
M611, BMP61	Fig. 2	M61-19-494-BL	B-494	Polyester	Blue	1.000 (25.4)	1.000 (25.4)	-	250	M61-R6410
M611, BMP61	Fig. 24	M61-98-494-GN	B-494	Polyester	Green	1.000 (25.4)	0.375 (9.5)	0.375 (9.5) dia.	500	M61-R6410
M611, BMP61	Fig. 2	M61-17-494-GN	B-494	Polyester	Green	1.000 (25.4)	0.500 (12.7)	-	500	M61-R6410
M611, BMP61	Fig. 2	M61-19-494-GN	B-494	Polyester	Green	1.000 (25.4)	1.000 (25.4)	-	250	M61-R6410
M611, BMP61	Fig. 24	M61-98-494-OR	B-494	Polyester	Orange	1.000 (25.4)	0.375 (9.5)	0.375 (9.5) dia.	500	M61-R6410
M611, BMP61	Fig. 2	M61-17-494-OR	B-494	Polyester	Orange	1.000 (25.4)	0.500 (12.7)	-	500	M61-R6410
M611, BMP61	Fig. 2	M61-19-494-OR	B-494	Polyester	Orange	1.000 (25.4)	1.000 (25.4)	-	250	M61-R6410
M611, BMP61	Fig. 24	M61-98-494-PK	B-494	Polyester	Pink	1.000 (25.4)	0.375 (9.5)	0.375 (9.5) dia.	500	M61-R6410
M611, BMP61	Fig. 2	M61-17-494-PK	B-494	Polyester	Pink	1.000 (25.4)	0.500 (12.7)	-	500	M61-R6410
M611, BMP61	Fig. 2	M61-19-494-PK	B-494	Polyester	Pink	1.000 (25.4)	1.000 (25.4)	-	250	M61-R6410
M611, BMP61	Fig. 24	M61-98-494-RD	B-494	Polyester	Red	1.000 (25.4)	0.375 (9.5)	0.375 (9.5) dia.	500	M61-R6410
M611, BMP61	Fig. 2	M61-17-494-RD	B-494	Polyester	Red	1.000 (25.4)	0.500 (12.7)	-	500	M61-R6410
M611, BMP61	Fig. 2	M61-19-494-RD	B-494	Polyester	Red	1.000 (25.4)	1.000 (25.4)	-	250	M61-R6410
M611, BMP61	Fig. 24	M61-98-494-YL	B-494	Polyester	Yellow	1.000 (25.4)	0.375 (9.5)	0.375 (9.5) dia.	500	M61-R6410
M611, BMP61	Fig. 2	M61-17-494-YL	B-494	Polyester	Yellow	1.000 (25.4)	0.500 (12.7)	-	500	M61-R6410
M611, BMP61	Fig. 2	M61-19-494-YL	B-494	Polyester	Yellow	1.000 (25.4)	1.000 (25.4)	-	250	M61-R6410

Nylon Cloth Lab Labels (B-499)

White nylon cloth designed for easy handling and conformability to tubes and vials. These labels withstand harsh temperatures and chemicals without falling off, fading or smearing.

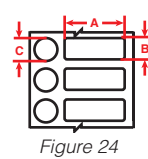
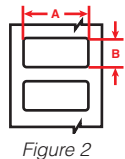

Fits Printers	Figure	Catalog #	B#	Material	Color	Label Width A Inch (mm)	Label Height B Inch (mm)	Secondary Label Inch (mm)	Labels Per Roll	Rec. Ribbon (M611 / BMP61)
M611, BMP61, 71*, TLS	Fig. 2	PTL-11-499	B-499	Vinyl	White	0.500 (12.7)	0.750 (19.1)	-	500	M61-R4310
M611, BMP61, 71*, TLS	Fig. 2	PTL-16-499	B-499	Vinyl	White	0.375 (9.53)	1.000 (25.4)	-	500	M61-R4310
M611, BMP61, 71*, TLS	Fig. 2	PTL-29-499	B-499	Vinyl	White	0.500 (12.7)	1.500 (38.1)	-	500	M61-R4310
M611, BMP61, 71*, TLS	Fig. 24	PTL-117-499	B-499	Vinyl	White	0.900 (22.86)	0.500 (12.7)	0.500 (12.7) dia.	500	M61-R4310
M611, BMP61, 71*, TLS	Fig. 2	PTL-84-499	B-499	Vinyl	White	0.900 (22.86)	0.500 (12.7)	-	500	M61-R4310
M611, BMP61, 71*, TLS	Fig. 24	PTL-98-499	B-499	Vinyl	White	1.000 (25.4)	0.375 (9.5)	0.375 (9.5) dia.	500	M61-R4310
M611, BMP61, 71*, TLS	Fig. 2	PTL-81-499	B-499	Vinyl	White	1.900 (48.26)	0.250 (6.4)	-	750	M61-R4310

Polypropylene Lab Labels (B-7425)

Material features moderate chemical resistance and is ideal for labeling dry, room temperature specimen containers. Chemical resistance to ethanol, DMSO, IPS, short term xylene, 10% formalin, 50% acetic acid and toluene. Temp. range: -196° C to 121° C (-320° F to 248° F).

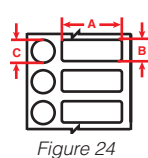
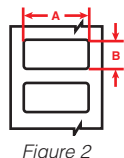

Fits Printers	Figure	Catalog #	B#	Material	Color	Label Width A Inch (mm)	Label Height B Inch (mm)	Secondary Label Inch (mm)	Labels Per Roll	Rec. Ribbon (M611 / BMP61)
M611, BMP61	Fig. 2	M61-2-7425	B-7425	Polypropylene	White	0.250 (6.35)	2.000 (50.8)	-	100	M61-R4310
M611, BMP61	Fig. 2	M61-7-7425	B-7425	Polypropylene	White	0.500 (12.7)	0.500 (12.7)	-	500	M61-R4310
M611, BMP61	Fig. 2	M61-18-7425	B-7425	Polypropylene	White	0.750 (19.1)	1.000 (25.4)	-	250	M61-R4310
M611, BMP61	Fig. 2	M61-17-7425	B-7425	Polypropylene	White	1.000 (25.4)	0.500 (12.7)	-	500	M61-R4310
M611, BMP61	Fig. 24	M61-98-7425	B-7425	Polypropylene	White	1.000 (25.4)	0.375 (9.5)	0.375 (9.5) dia.	500	M61-R4310
M611, BMP61	Fig. 2	M61-199-7425	B-7425	Polypropylene	White	1.300 (33.0)	0.600 (15.2)	-	250	M61-R4310
M611, BMP61	Fig. 2	M61-31-7425	B-7425	Polypropylene	White	1.500 (38.1)	1.000 (25.4)	-	250	M61-R4310
M611, BMP61	Fig. 2	M61-121-7425	B-7425	Polypropylene	White	1.900 (48.3)	1.500 (38.1)	-	100	M61-R4310

BradyPrinter M611 / BMP®61 Ribbons

BradyID.com/s36



BradyPrinter M611 and BMP61 Print Ribbons

Print ribbons are supplied in cartridge form and easily fit into the side of the printer and do not unravel or roll away when outside the printer.

Using the correct material and ribbon pair is critical in creating durable, long-lasting and smear-proof print. Use the ribbon compatibility guide on the next page to help determine which ribbon is best suited for your label material.

Fits Printers	Catalog #	Color	Description	Ribbon Size
M611, BMP61	M61-R4310	Black	R4300 Series	2 in. x 75 ft. (50.8 mm x 22.85 m)
M611, BMP61	M61-R6010	Black	R6000 Series	2 in. x 75 ft. (50.8 mm x 22.85 m)
M611, BMP61	M61-R6210	Black	R6200 Series	2 in. x 75 ft. (50.8 mm x 22.85 m)
M611, BMP61	M61-R6410	Black	R6410 Series	2 in. x 75 ft. (50.8 mm x 22.85 m)
M611, BMP61	M61-R6610	Black	R6600 Series	2 in. x 75 ft. (50.8 mm x 22.85 m)
M611, BMP61	M61-R6710-WT	White	R6710 Series	2 in. x 75 ft. (50.8 mm x 22.85 m)
M611, BMP61	M61-R6810-WT	White	R6800 Series	2 in. x 75 ft. (50.8 mm x 22.85 m)
M611, BMP61	M61-R4410-RD	Red	R4400 Series	2 in. x 75 ft. (50.8 mm x 22.85 m)
M611, BMP61	M61-R4410-BL	Blue	R4400 Series	2 in. x 75 ft. (50.8 mm x 22.85 m)

Portable Printers



How many labels can be printed per ribbon?

Have you ever wondered approximately how many labels you can print from one BMP61 ribbon? Try this formula:

Note: Our standard ribbons are 900 in. (75 ft.) long.

- Step 1:** label height + 0.10 = X
Step 2: 900 inches ÷ X = total labels per ribbon

Example: PLT-19-422 is a 1.0 inch tall label
 1.0 inch label height + 0.10 = 1.10
 900 inches ÷ 1.10 = 818 labels per ribbon

M611 / BMP61

TLS®2200 Print Ribbons

Although the TLS2200 and the BMP61 share label rolls, each printer requires its own printer-specific ribbon.



Fits Printers	Catalog #	Color	Description	Ribbon Size
TLS2200 Only	R4310	Black	R4300 Series	2 in. x 75 ft. (50.8 mm x 22.85 m)
TLS2200 Only	R6010	Black	R6000 Series	2 in. x 75 ft. (50.8 mm x 22.85 m)
TLS2200 Only	R6210	Black	R6200 Series	2 in. x 75 ft. (50.8 mm x 22.85 m)
TLS2200 Only	R6410	Black	R6400 Series	2 in. x 75 ft. (50.8 mm x 22.85 m)
TLS2200 Only	R4410-WT	White	R4400 Series	2 in. x 75 ft. (50.8 mm x 22.85 m)
TLS2200 Only	R6810-WT	White	R6800 Series	2 in. x 75 ft. (50.8 mm x 22.85 m)
TLS2200 Only	R4410-BL	Red	R4400 Series	2 in. x 75 ft. (50.8 mm x 22.85 m)
TLS2200 Only	R4410-RD	Blue	R4400 Series	2 in. x 75 ft. (50.8 mm x 22.85 m)

Material and Ribbon Compatibility

B-# Material		M61-R4310 (Black)	M61-R6010 (Black)	M61-R6210 (Black)	M61-R6410 (Black)	M61-R6610 (Black)	M61-R4410-WT (White)	M61-R6710-WT (White)	M61-R6810-WT (White)	M61-R4410-RED (Red)	M61-R4410-BL (Blue)
B-109	Polyethylene tag	●		●							
B-145	Polyethylene tag		●								
B-145FR	Polyethylene tag		●	▲							
B-321	Polyolefin			●							
B-342	PermaSleeve® polyolefin	●				●			▲		
B-344	PermaSleeve® polyolefin		●			●			▲		
B-345	PermaSleeve® high-temp polyolefin		●			●					
B-351	Destructible vinyl		●	●			▲		▲		
B-352	Destructible vinyl		●								
B-362	Destructible vinyl		●								
B-390	Durasleeve® polypropylene		●	▲		●					
B-403	Dissolvable paper	●									
B-412	Polypropylene tag	●		●							
B-422	Polyester		●				●			▲	▲
B-423	Polyester		●				●			▲	▲
B-424	Paper	●									
B-425	Polypropylene	●		●							
B-427	Self-laminating vinyl	●									
B-428	Polyester	●									
B-430	Polyester		●	●			▲			▲	▲
B-432	Polyester		●				●			▲	▲
B-435	Polyester		●								
B-437	Self-extinguishing polyvinylfluoride	●		●							
B-439	Vinyl		●				●			▲	▲
B-459	Polyester		●								
B-461	Self-laminating polyester	●		●							
B-473	Polyester		●								
B-483	Polyester		●								
B-486	Polyester	●									
B-488	Polyester	●									
B-489	Polyester	●									
B-490	Freezerbondz™ polyester	●									
B-494	Color polyester				●						
B-498	Vinyl cloth	●	▲	▲		●					
B-499	Nylon cloth	●		●							
B-593	Polyester - eprep		●				●			▲	▲
B-642	Self-extinguishing polyvinylfluoride	●		●							
B-717	Polyimide		●								
B-718	Polyimide		●								
B-719	Polyimide		●								
B-724	Polyimide	●									
B-727	Polyimide		●								
B-7351	Void print vinyl		●								
B-7425	Polypropylene	●									
B-7546	Void print polyester		●								
B-7551-CL	Polyester			●							
B-7576	Void print polyester		●								
B-7593	Polyethylene - eprep		●				●				
B-7597	Polyethylene	●								▲	
B-7599-YL	Polyethylene tag			●							
B-7643	Thermoplastic polyether polyurethane		●								
B-7696	Vinyl tag		●	●							
B-8425	Polypropylene		●								
B-8451	Polyester		●								
B-8459	Polyester					●					

View BradyID.com/techdata for TDS sheets on ribbon performance specifications.

Note: Colored ribbon choice dependent upon material color.

- Recommended ribbon for use with respective material
- ▲ Acceptable ribbon for use with respective material

BMP®71 Label Printer

BradyID.com/s36



Portable Printers

BMP71

BMP®71 LABEL PRINTER

**Thousands of applications
Hundreds of labels
One label printer**

The most versatile portable printer in our offering. Painless setup, robust label offering and intuitive interface come together in our top-of-the-line portable printer.

Text and print options:

- 100's of symbols
- Reverse print
- Subscripts
- Auto font size
- Barcodes
- Serialization
- Time and date stamps
- Underline
- Italics and bold
- Vertical printing
- And more

▶ Watch the demo video at BradyID.com/bmp71

Your complete printing solution:

BMP71 label rolls page 154
BMP71 print ribbons page 170

BMP71 label printer and accessories

Catalog #	Description
BMP71	BMP71 Printer*
BMP71-QC	BMP71 Printer* w/ Quick Charger
BMP71-SC	BMP71 Printer* w/ Soft Case
BMP71-SC-QC	BMP71 Printer* w/ Soft Case and Quick Charger
M-AC-143110	BMP71 AC / Battery Adapter
M71-ADAPT-BK	Media Adapter
M71-BATT	BMP71 Battery Pack
M-USB-103788	BMP71 USB Cable
M71-CLEAN	BMP71 Cleaning Kit
M71-HC	BMP71 Hardcase
M71-QC	BMP71 Quick Charger
BMP-SC-3	BMP71 Soft Case

*Printer ships with hardcase, charger / AC adapter, (1) roll of 1.0 x 1.5 in. white die-cut labels, (1) black ribbon cartridge, media adapter, rechargeable battery, USB cable, quickstart guide, drivers CD, users guide, tutorial and 2-year limited warranty.

U.S. Patent No. 7,999,836; 8,328,442; 8,333,524.



Printer specifications	
Print speed	1.5 in. / sec
Print and color capabilities	Thermal Transfer / Monochrome
Print resolution	300 dpi
PC compatibility or standalone	Standalone and PC connect
Connectivity options	USB Port B
Software compatibility	Brady Workstation Apps, LabelMark™ Software
Power supply options	NiMH battery, AC adapter
Standard warranty	2 years
Dimensions	9.5 in. W x 13.0 in. H x 4.6 in. D
Weight	4.9 lbs. (w/o tape, batteries)
Print features	
Screen size	LCD, Color, 3.5 in. QVGA
Backlit screen	Yes
Keyboard style	QWERTY, Number Keypad
Max print width	1.92 in.
Font types available	(2) Brady Alpine and Brady Fixed Width
Font sizes (pts)	4 through 174, autosizing
Multi-line label capabilities	25
Label print rotation	Yes
Data serialization	Yes, multiple and linked
Barcode capabilities and types	Code 39, Code 128 and more using Brady Workstation
Memory capacity	200 MB
Data transfer from PC	Yes
Print preview	Yes
Symbols available	500+
Label supplies	
Label / ribbon supply	Separate label roll and ribbon cartridges
Material formats supported	Continuous, die-cut labels and custom
Media width	0.235 to 2.00 in.
Types of materials	Outdoor vinyl, nylon cloth wire ID, heat-shrink wire ID, self-laminating wire ID, removable cloth wire ID, Teclur wire ID, datacomm cable tags, standard polyester, aggressive adhesive polyester, metallized polyester, non-adhesive tag, polyimide / electronics materials, tamper resistant materials, outdoor reflective, glow-in-the-dark, ToughStripe floor tape, ToughWash, repositionable vinyl, raised panel labels (engraved plate alternative)
Quantity of label parts available	300+ label parts and customs
Cartridge series	M71 series, BM71, PTL series with adapter and some BMP61 labels with adapter (TLS and BMP61 ribbons not compatible)

The one way to faster, easier label printing



Electrical labeling



Voice and data communications



Rating plates and general ID



PermaSleeve® wire markers



Self-laminating labels



Safety labels and more



Brady Workstation Software

Desktop software for your Brady Printer

Brady Workstation has revolutionized how you design and print labels from your PC. When paired with the high-performance printing capabilities of a Brady printer, you get intuitive label set up for simple, efficient and flexible label creation.

- Suites designed with you in mind, contain apps for common safety and facility label designs, product and wire label creation, printing workflows and more
- Displays real-time information about the material installed for easy label set up
- Apps feature built-in regulations, standards, pictograms, common phrases, data importation guidance, help functions and more



Learn more on page 176 or download a free trial at Workstation.BradylD.com

Expand your label options with the BMP71 media adapter

Your BMP71 printer includes a black media adapter that allows you to convert many BMP®61 label rolls to fit your BMP71 printer. (Requires BMP71 printer firmware upgrade 1.13 or higher.)

View BMP61 label rolls on page 130–148.

Need additional adapters? Order catalog # M71-ADAPT-BK



BMP61 label roll

BMP61 label roll with black media adapter attached



Indoor and Outdoor Vinyl Labels for Safety, Facility and Lean 5S (B-595)

Continuous vinyl material is ideal for lean 5S labels, pipe markers, equipment and production area identification. These labels offer excellent resistance to oils, detergents, dirt, grime and many solvents. Permanent adhesive, very pliable, good for rough surfaces and outdoor use. 8-10 years average outdoor durability.* Temp. range: -40° F to 180° F (-40° C to 82° C). UL recognized.



Figure 33



Figure	Catalog #	B#	Material	Color	Label Width A Inch (mm)	Roll Length B Feet (m)	Labels Per Roll	Rec. Ribbon
Fig. 33	M71C-250-595-WT	B-595	Vinyl	White	0.250 (6.4)	50 (15.2)	1 roll (cont.)	M71-R6000
Fig. 33	M71C-500-595-WT	B-595	Vinyl	White	0.500 (12.7)	50 (15.2)	1 roll (cont.)	M71-R6000
Fig. 33	M71C-1000-595-WT	B-595	Vinyl	White	1.000 (25.4)	50 (15.2)	1 roll (cont.)	M71-R6000
Fig. 33	M71C-2000-595-WT	B-595	Vinyl	White	2.000 (50.8)	50 (15.2)	1 roll (cont.)	M71-R6000
Fig. 33	M71C-250-595-YL	B-595	Vinyl	Yellow	0.250 (6.4)	50 (15.2)	1 roll (cont.)	M71-R6000
Fig. 33	M71C-500-595-YL	B-595	Vinyl	Yellow	0.500 (12.7)	50 (15.2)	1 roll (cont.)	M71-R6000
Fig. 33	M71C-1000-595-YL	B-595	Vinyl	Yellow	1.000 (25.4)	50 (15.2)	1 roll (cont.)	M71-R6000
Fig. 33	M71C-2000-595-YL	B-595	Vinyl	Yellow	2.000 (50.8)	50 (15.2)	1 roll (cont.)	M71-R6000
Fig. 33	M71C-500-595-BK	B-595	Vinyl	Black	0.500 (12.7)	50 (15.2)	1 roll (cont.)	M71-R4400-WT
Fig. 33	M71C-1000-595-BK	B-595	Vinyl	Black	1.000 (25.4)	50 (15.2)	1 roll (cont.)	M71-R4400-WT
Fig. 33	M71C-2000-595-BK	B-595	Vinyl	Black	2.000 (50.8)	50 (15.2)	1 roll (cont.)	M71-R4400-WT
Fig. 33	M71C-500-595-BL	B-595	Vinyl	Blue	0.500 (12.7)	50 (15.2)	1 roll (cont.)	M71-R4400-WT
Fig. 33	M71C-1000-595-BL	B-595	Vinyl	Blue	1.000 (25.4)	50 (15.2)	1 roll (cont.)	M71-R4400-WT
Fig. 33	M71C-2000-595-BL	B-595	Vinyl	Blue	2.000 (50.8)	50 (15.2)	1 roll (cont.)	M71-R4400-WT
Fig. 33	M71C-500-595-BR	B-595	Vinyl	Brown	0.500 (12.7)	50 (15.2)	1 roll (cont.)	M71-R4400-WT
Fig. 33	M71C-1000-595-BR	B-595	Vinyl	Brown	1.000 (25.4)	50 (15.2)	1 roll (cont.)	M71-R4400-WT
Fig. 33	M71C-2000-595-BR	B-595	Vinyl	Brown	2.000 (50.8)	50 (15.2)	1 roll (cont.)	M71-R4400-WT
Fig. 33	M71C-500-595-CL	B-595	Vinyl	Clear	0.500 (12.7)	50 (15.2)	1 roll (cont.)	M71-R6000
Fig. 33	M71C-1000-595-CL	B-595	Vinyl	Clear	1.000 (25.4)	50 (15.2)	1 roll (cont.)	M71-R6000
Fig. 33	M71C-2000-595-CL	B-595	Vinyl	Clear	2.000 (50.8)	50 (15.2)	1 roll (cont.)	M71-R6000
Fig. 33	M71C-500-595-GD	B-595	Vinyl	Gold	0.500 (12.7)	50 (15.2)	1 roll (cont.)	M71-R6000
Fig. 33	M71C-1000-595-GD	B-595	Vinyl	Gold	1.000 (25.4)	50 (15.2)	1 roll (cont.)	M71-R6000
Fig. 33	M71C-2000-595-GD	B-595	Vinyl	Gold	2.000 (50.8)	50 (15.2)	1 roll (cont.)	M71-R6000
Fig. 33	M71C-500-595-GN	B-595	Vinyl	Green	0.500 (12.7)	50 (15.2)	1 roll (cont.)	M71-R4400-WT
Fig. 33	M71C-1000-595-GN	B-595	Vinyl	Green	1.000 (25.4)	50 (15.2)	1 roll (cont.)	M71-R4400-WT
Fig. 33	M71C-2000-595-GN	B-595	Vinyl	Green	2.000 (50.8)	50 (15.2)	1 roll (cont.)	M71-R4400-WT
Fig. 33	M71C-500-595-GY	B-595	Vinyl	Gray	0.500 (12.7)	50 (15.2)	1 roll (cont.)	M71-R6000
Fig. 33	M71C-1000-595-GY	B-595	Vinyl	Gray	1.000 (25.4)	50 (15.2)	1 roll (cont.)	M71-R6000
Fig. 33	M71C-2000-595-GY	B-595	Vinyl	Gray	2.000 (50.8)	50 (15.2)	1 roll (cont.)	M71-R6000
Fig. 33	M71C-500-595-LB	B-595	Vinyl	Light Blue	0.500 (12.7)	50 (15.2)	1 roll (cont.)	M71-R6000
Fig. 33	M71C-1000-595-LB	B-595	Vinyl	Light Blue	1.000 (25.4)	50 (15.2)	1 roll (cont.)	M71-R6000
Fig. 33	M71C-2000-595-LB	B-595	Vinyl	Light Blue	2.000 (50.8)	50 (15.2)	1 roll (cont.)	M71-R6000
Fig. 33	M71C-500-595-OC	B-595	Vinyl	Ochre	0.500 (12.7)	50 (15.2)	1 roll (cont.)	M71-R6000
Fig. 33	M71C-1000-595-OC	B-595	Vinyl	Ochre	1.000 (25.4)	50 (15.2)	1 roll (cont.)	M71-R6000
Fig. 33	M71C-2000-595-OC	B-595	Vinyl	Ochre	2.000 (50.8)	50 (15.2)	1 roll (cont.)	M71-R6000
Fig. 33	M71C-500-595-OR	B-595	Vinyl	Orange	0.500 (12.7)	50 (15.2)	1 roll (cont.)	M71-R6000
Fig. 33	M71C-1000-595-OR	B-595	Vinyl	Orange	1.000 (25.4)	50 (15.2)	1 roll (cont.)	M71-R6000
Fig. 33	M71C-2000-595-OR	B-595	Vinyl	Orange	2.000 (50.8)	50 (15.2)	1 roll (cont.)	M71-R6000
Fig. 33	M71C-500-595-PK	B-595	Vinyl	Pink	0.500 (12.7)	50 (15.2)	1 roll (cont.)	M71-R6000
Fig. 33	M71C-1000-595-PK	B-595	Vinyl	Pink	1.000 (25.4)	50 (15.2)	1 roll (cont.)	M71-R6000
Fig. 33	M71C-2000-595-PK	B-595	Vinyl	Pink	2.000 (50.8)	50 (15.2)	1 roll (cont.)	M71-R6000
Fig. 33	M71C-500-595-PL	B-595	Vinyl	Purple	0.500 (12.7)	50 (15.2)	1 roll (cont.)	M71-R4400-WT
Fig. 33	M71C-1000-595-PL	B-595	Vinyl	Purple	1.000 (25.4)	50 (15.2)	1 roll (cont.)	M71-R4400-WT
Fig. 33	M71C-2000-595-PL	B-595	Vinyl	Purple	2.000 (50.8)	50 (15.2)	1 roll (cont.)	M71-R4400-WT
Fig. 33	M71C-500-595-RD	B-595	Vinyl	Red	0.500 (12.7)	50 (15.2)	1 roll (cont.)	M71-R4400-WT
Fig. 33	M71C-1000-595-RD	B-595	Vinyl	Red	1.000 (25.4)	50 (15.2)	1 roll (cont.)	M71-R4400-WT
Fig. 33	M71C-2000-595-RD	B-595	Vinyl	Red	2.000 (50.8)	50 (15.2)	1 roll (cont.)	M71-R4400-WT
Fig. 33	M71C-500-595-SB	B-595	Vinyl	Sky Blue	0.500 (12.7)	50 (15.2)	1 roll (cont.)	M71-R6000
Fig. 33	M71C-1000-595-SB	B-595	Vinyl	Sky Blue	1.000 (25.4)	50 (15.2)	1 roll (cont.)	M71-R6000
Fig. 33	M71C-2000-595-SB	B-595	Vinyl	Sky Blue	2.000 (50.8)	50 (15.2)	1 roll (cont.)	M71-R6000
Fig. 33	M71C-500-595-TN	B-595	Vinyl	Tan	0.500 (12.7)	50 (15.2)	1 roll (cont.)	M71-R6000
Fig. 33	M71C-1000-595-TN	B-595	Vinyl	Tan	1.000 (25.4)	50 (15.2)	1 roll (cont.)	M71-R6000
Fig. 33	M71C-2000-595-TN	B-595	Vinyl	Tan	2.000 (50.8)	50 (15.2)	1 roll (cont.)	M71-R6000

* Average expected outdoor life of product will depend on user definition of failure, climatic conditions, mounting techniques and material color. The 8 to 10 year outdoor durability applies to the vinyl label stock only; ribbon durability will vary.

ToughWash[®] Harsh Washdown Labels (B-854 and B-855)

Specially formulated material for the Food and Beverage Processing industry with the ability to withstand washdowns up to 175° F (80° C) and pressure up to 1500 PSI.

- **B-854 ToughWash Metal Detectable Polyester:** Polyester material with aggressive adhesive. Capable of being detected by commercially available metal detectors
- **B-855 ToughWash Polyester:** Polyester material with aggressive acrylic adhesive

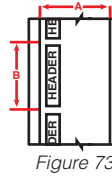
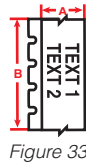

Figure	Catalog #	B#	Legend	Label Width A Inch (mm)	Length B Inch (mm)	Labels Per Roll	Rec. Ribbon
B-854 ToughWash[®] Metal Detectable Material							
Fig. 33	BM71C-1000-854-WT	B-854		1.000 (25.4)	75ft. (22.8 m)	1 roll (cont.)	M71-R6000
Fig. 33	BM71C-2000-854-WT	B-854		2.000 (50.8)	75ft. (22.8 m)	1 roll (cont.)	M71-R6000
Fig. 33	BM71C-1000-854-YL	B-854		1.000 (25.4)	75ft. (22.8 m)	1 roll (cont.)	M71-R6000
Fig. 33	BM71C-2000-854-YL	B-854		2.000 (50.8)	75ft. (22.8 m)	1 roll (cont.)	M71-R6000
Fig. 73	BM71C-2000-854-CAU	B-854		2.000 (50.8)	4.125 (104.8)	225	M71-R6000
Fig. 73	BM71C-2000-854-DAN	B-854		2.000 (50.8)	4.125 (104.8)	225	M71-R6000
Fig. 73	BM71C-2000-854-WAR	B-854		2.000 (50.8)	4.125 (104.8)	225	M71-R6000
B-855 ToughWash[®] Material							
Fig. 33	BM71C-1000-855-WT	B-855		1.000 (25.4)	75ft. (22.8 m)	1 roll (cont.)	M71-R6000
Fig. 33	BM71C-2000-855-WT	B-855		2.000 (50.8)	75ft. (22.8 m)	1 roll (cont.)	M71-R6000
Fig. 33	BM71C-1000-855-YL	B-855		1.000 (25.4)	75ft. (22.8 m)	1 roll (cont.)	M71-R6000
Fig. 33	BM71C-2000-855-YL	B-855		2.000 (50.8)	75ft. (22.8 m)	1 roll (cont.)	M71-R6000
Fig. 73	BM71C-2000-855-CAU	B-855		2.000 (50.8)	4.125 (104.8)	225	M71-R6000
Fig. 73	BM71C-2000-855-DAN	B-855		2.000 (50.8)	4.125 (104.8)	225	M71-R6000
Fig. 73	BM71C-2000-855-WAR	B-855		2.000 (50.8)	4.125 (104.8)	225	M71-R6000

ToughStripe[®] Floor Marking Labels (B-483)

Print on demand ToughStripe polyester floor marking material features the same durability and performance as ToughStripe tape with its high-adhesion to flat, non-coated concrete. Includes a roll of B-634 clear overlamine to protect printing. Temp. range: -40° F to 248° F (-40° C to 120° C).

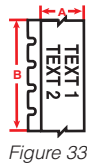

Figure	Catalog #	B#	Material	Color	Label Width A Inch (mm)	Roll Length B Feet (m)	Labels Per Roll	Rec. Ribbon
Fig. 33	M71-1000-483-WT-KT	B-483	Polyester	White	1.0 (25.4)	50 (15.2)	1 roll (cont.)	M71-R6000
Fig. 33	M71-2000-483-WT-KT	B-483	Polyester	White	2.0 (50.8)	50 (15.2)	1 roll (cont.)	M71-R6000
Fig. 33	M71-1000-483-YL-KT	B-483	Polyester	Yellow	1.0 (25.4)	50 (15.2)	1 roll (cont.)	M71-R6000
Fig. 33	M71-2000-483-YL-KT	B-483	Polyester	Yellow	2.0 (50.8)	50 (15.2)	1 roll (cont.)	M71-R6000
Fig. 33	M71-1000-483-BK-KT	B-483	Polyester	Black	1.0 (25.4)	50 (15.2)	1 roll (cont.)	M71-R4400-WT
Fig. 33	M71-2000-483-BK-KT	B-483	Polyester	Black	2.0 (50.8)	50 (15.2)	1 roll (cont.)	M71-R4400-WT
Fig. 33	M71-1000-483-BL-KT	B-483	Polyester	Blue	1.0 (25.4)	50 (15.2)	1 roll (cont.)	M71-R4400-WT
Fig. 33	M71-2000-483-BL-KT	B-483	Polyester	Blue	2.0 (50.8)	50 (15.2)	1 roll (cont.)	M71-R4400-WT
Fig. 33	M71-1000-483-GN-KT	B-483	Polyester	Green	1.0 (25.4)	50 (15.2)	1 roll (cont.)	M71-R4400-WT
Fig. 33	M71-2000-483-GN-KT	B-483	Polyester	Green	2.0 (50.8)	50 (15.2)	1 roll (cont.)	M71-R4400-WT
Fig. 33	M71-1000-483-OR-KT	B-483	Polyester	Orange	1.0 (25.4)	50 (15.2)	1 roll (cont.)	M71-R6000
Fig. 33	M71-2000-483-OR-KT	B-483	Polyester	Orange	2.0 (50.8)	50 (15.2)	1 roll (cont.)	M71-R6000
Fig. 33	M71-1000-483-RD-KT	B-483	Polyester	Red	1.0 (25.4)	50 (15.2)	1 roll (cont.)	M71-R6000
Fig. 33	M71-2000-483-RD-KT	B-483	Polyester	Red	2.0 (50.8)	50 (15.2)	1 roll (cont.)	M71-R6000

General Identification and Rating Plate Labels (B-424, B-430, B-459, B-483, B-486, B-488, B-489 and B-8591)

Choose from several materials with aggressive adhesives for use in commercial and industrial applications.

- **B-424 Paper Material:** White matte paper material
- **B-430 Polyester Material:** Clear glossy polyester
- **B-459 Polyester Material:** White matte polyester
- **B-483 Polyester Material:** White glossy polyester with an aggressive rubber-based adhesive
- **B-486 Polyester Material:** Metallized matte polyester with an aggressive adhesive
- **B-488 Polyester Material:** White matte polyester with an aggressive adhesive
- **B-489 Polyester Material:** White matte polyester with an aggressive adhesive
- **B-8591 Outdoor Polyester Material:** Permanent adhesive, 12-year outdoor durability, resists UV, abrasion and fluids

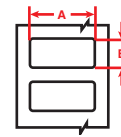

Figure 2



Figure 33

Figure	Catalog #	B#	Material	Color	Label Width A Inch (mm)	Label Height B Inch (mm)	Labels Per Roll	Rec. Ribbon
B-424 Paper								
Fig. 2	BM71-20-424	B-424	Paper	Matte White	2.000 (50.8)	1.000 (25.4)	1,000	M71-R4300
Fig. 2	M71-20-424	B-424	Paper	Matte White	2.000 (50.8)	1.000 (25.4)	100	M71-R4300
B-430 Clear Glossy Polyester								
Fig. 2	M71-68-430	B-430	Polyester	Glossy Clear	0.240 (6.0)	0.150 (3.8)	750	M71-R6000
Fig. 2	M71-71-430	B-430	Polyester	Glossy Clear	0.350 (8.9)	0.200 (5.1)	750	M71-R6000
Fig. 33	M71C-375-430	B-430	Polyester	Glossy Clear	0.375 (9.5)	50 ft. (15.2 m)	1 roll (cont.)	M71-R6000
Fig. 33	M71C-500-430	B-430	Polyester	Glossy Clear	0.500 (12.7)	50 ft. (15.2 m)	1 roll (cont.)	M71-R6000
Fig. 2	M71-16-430	B-430	Polyester	Glossy Clear	1.000 (25.4)	0.375 (9.5)	500	M71-R6000
Fig. 2	M71-17-430	B-430	Polyester	Glossy Clear	1.000 (25.4)	0.500 (12.7)	500	M71-R6000
Fig. 33	M71C-1000-430	B-430	Polyester	Glossy Clear	1.000 (25.4)	50 ft. (15.2 m)	1 roll (cont.)	M71-R6000
Fig. 2	M71-45-430	B-430	Polyester	Glossy Clear	1.050 (38.1)	0.375 (9.5)	500	M71-R6000
Fig. 33	M71C-1900-430	B-430	Polyester	Glossy Clear	1.900 (48.3)	50 ft. (15.2 m)	1 roll (cont.)	M71-R6000
B-459 Matte Polyester								
Fig. 2	M71-29-459	B-459	Polyester	Matte White	1.500 (38.1)	0.500 (12.7)	500	M71-R6000
Fig. 2	M71-30-459	B-459	Polyester	Matte White	1.500 (38.1)	0.750 (19.1)	250	M71-R6000
Fig. 2	M71-20-459	B-459	Polyester	Matte White	2.000 (50.8)	1.000 (25.4)	100	M71-R6000
B-483 Gloss Polyester								
Fig. 33	M71C-500-483	B-483	Polyester	Glossy Clear	0.500 (12.7)	50 ft. (15.2 m)	1 roll (cont.)	M71-R6000
Fig. 2	M71-16-483	B-483	Polyester	Glossy Clear	1.000 (25.4)	0.375 (9.5)	500	M71-R6000
Fig. 2	M71-17-483	B-483	Polyester	Glossy Clear	1.000 (25.4)	0.500 (12.7)	500	M71-R6000
Fig. 2	M71-19-483	B-483	Polyester	Glossy Clear	1.000 (25.4)	1.000 (25.4)	250	M71-R6000
Fig. 33	M71C-1000-483	B-483	Polyester	Glossy Clear	1.000 (25.4)	50 ft. (15.2 m)	1 roll (cont.)	M71-R6000
Fig. 2	M71-65-483	B-483	Polyester	Glossy Clear	1.375 (34.9)	1.000 (25.4)	250	M71-R6000
Fig. 2	M71-29-483	B-483	Polyester	Glossy Clear	1.500 (38.1)	0.500 (12.7)	500	M71-R6000
Fig. 2	M71-30-483	B-483	Polyester	Glossy Clear	1.500 (38.1)	0.750 (19.1)	250	M71-R6000
Fig. 2	M71-31-483	B-483	Polyester	Glossy Clear	1.500 (38.1)	1.000 (25.4)	250	M71-R6000
Fig. 33	M71C-1900-483	B-483	Polyester	Glossy Clear	1.900 (48.3)	50 ft. (15.2 m)	1 roll (cont.)	M71-R6000
Fig. 2	M71-61-483	B-483	Polyester	Glossy Clear	2.000 (50.8)	0.500 (12.7)	100	M71-R6000
Fig. 2	M71-20-483	B-483	Polyester	Glossy Clear	2.000 (50.8)	1.000 (25.4)	100	M71-R6000
Fig. 2	M71-37-483	B-483	Polyester	Glossy Clear	3.000 (76.2)	1.900 (48.3)	100	M71-R6000
Fig. 2	M71-23-483	B-483	Polyester	Glossy Clear	4.000 (101.6)	1.000 (25.4)	100	M71-R6000
Fig. 2	M71-38-483	B-483	Polyester	Glossy Clear	4.000 (101.6)	1.900 (48.3)	100	M71-R6000
B-486 Metallized Polyester								
Fig. 2	M71-17-486	B-486	Polyester	Silver	1.000 (25.4)	0.500 (12.7)	500	M71-R4300
Fig. 2	M71-29-486	B-486	Polyester	Silver	1.500 (38.1)	0.500 (12.7)	500	M71-R4300
Fig. 2	M71-30-486	B-486	Polyester	Silver	1.500 (38.1)	0.750 (19.1)	250	M71-R4300
Fig. 2	M71-20-486	B-486	Polyester	Silver	2.000 (50.8)	1.000 (25.4)	100	M71-R4300
Fig. 2	M71-37-486	B-486	Polyester	Silver	3.000 (76.2)	1.900 (48.3)	100	M71-R4300
B-488 Matte Polyester								
Fig. 2	M71-80-488	B-488	Polyester	Matte White	0.750 (19.1)	0.900 (22.9)	250	M71-R4300
Fig. 2	M71-97-488	B-488	Polyester	Matte White	0.900 (22.9)	0.900 (22.9)	250	M71-R4300
Fig. 2	M71-81-488	B-488	Polyester	Matte White	1.900 (48.3)	0.250 (6.4)	750	M71-R4300
B-489 Matte Polyester								
Fig. 2	M71-17-489	B-489	Polyester	Matte White	1.000 (25.4)	0.500 (12.7)	500	M71-R4300
Fig. 2	M71-29-489	B-489	Polyester	Matte White	1.500 (38.1)	0.500 (12.7)	500	M71-R4300
Fig. 2	M71-32-489	B-489	Polyester	Matte White	1.500 (38.1)	1.500 (38.1)	250	M71-R4300
Fig. 2	M71-38-489	B-489	Polyester	White	4.000 (101.6)	1.900 (48.3)	100	M71-R4300
B-8591 Outdoor Glossy Polyester								
Fig. 33	M71C-1000-8591	B-8591	Polyester	Glossy White	1.000 (25.4)	50 ft (15.24 m)	1 roll (cont.)	M71-R6600
Fig. 33	M71C-1900-8591	B-8591	Polyester	Glossy White	1.900 (48.3)	50 ft (15.24 m)	1 roll (cont.)	M71-R6600

Repositionable Vinyl Material (B-581)

Indoor / outdoor vinyl is a high-gloss, durable, flexible material designed with special adhesive to easily remove and re-apply.



Figure 33



Figure	Catalog #	B#	Material	Color	Label Width A Inch (mm)	Roll Length B Feet (m)	Labels Per Roll	Rec. Ribbon
Fig. 33	M71C-500-581-WT	B-581	Vinyl	White	0.500 (12.7)	50 (15.2)	1 roll (cont.)	M71-R6000
Fig. 33	M71C-1000-581-WT	B-581	Vinyl	White	1.000 (25.4)	50 (15.2)	1 roll (cont.)	M71-R6000
Fig. 33	M71C-2000-581-WT	B-581	Vinyl	White	2.000 (50.8)	50 (15.2)	1 roll (cont.)	M71-R6000
Fig. 33	M71C-500-581-YL	B-581	Vinyl	Yellow	0.500 (12.7)	50 (15.2)	1 roll (cont.)	M71-R6000
Fig. 33	M71C-1000-581-YL	B-581	Vinyl	Yellow	1.000 (25.4)	50 (15.2)	1 roll (cont.)	M71-R6000
Fig. 33	M71C-2000-581-YL	B-581	Vinyl	Yellow	2.000 (50.8)	50 (15.2)	1 roll (cont.)	M71-R6000

BradyGlo™ Phosphorescent Polyester Material (B-582)

Glow-in-the-dark pressure sensitive polyester is ideal for identification of fire alarms, extinguishers and emergency evacuation routes. Photoluminescent material charges in 5 minutes at 1000 Lux for 10+ hours of glow time. Temp range: -40° F to 176° F (-40° C to 80° C).



Figure 33



Figure	Catalog #	B#	Material	Color	Label Width A Inch (mm)	Roll Length B Feet (m)	Labels Per Roll	Rec. Ribbon
Fig. 33	BM71C-1000-582	B-582	Polyester	Phosphorescent	1.000 (25.4)	75 (22.8)	1 roll (cont.)	M71-R6000
Fig. 33	BM71C-2000-582	B-582	Polyester	Phosphorescent	2.000 (50.8)	75 (22.8)	1 roll (cont.)	M71-R6000

Reflective Material (B-584)

Reflective material shines back brightly when struck by light, making it ideal for labeling outdoor utility poles, hard hats, jobsite equipment and roof-top equipment. Meets Federal Spec L-S-300 for reflectivity. Average outdoor durability is 4-6 years. Temp. range: -40° F to 158° F (-40° C to 70° C).



Figure 33



Figure	Catalog #	B#	Material	Color	Label Width A Inch (mm)	Roll Length B Feet (m)	Labels Per Roll	Rec. Ribbon
Fig. 33	BM71C-1000-584-YL	B-584	Reflective Tape	Yellow	1.000 (25.4)	75 (22.8)	1 roll (cont.)	M71-R6000
Fig. 33	BM71C-2000-584-YL	B-584	Reflective Tape	Yellow	2.000 (50.8)	75 (22.8)	1 roll (cont.)	M71-R6000
Fig. 33	BM71C-1000-584-OR	B-584	Reflective Tape	Orange	1.000 (25.4)	75 (22.8)	1 roll (cont.)	M71-R6000
Fig. 33	BM71C-2000-584-OR	B-584	Reflective Tape	Orange	2.000 (50.8)	75 (22.8)	1 roll (cont.)	M71-R6000
Fig. 33	BM71C-1000-584-WT	B-584	Reflective Tape	Silver	1.000 (25.4)	75 (22.8)	1 roll (cont.)	M71-R6000
Fig. 33	BM71C-2000-584-WT	B-584	Reflective Tape	Silver	2.000 (50.8)	75 (22.8)	1 roll (cont.)	M71-R6000

Water-Dissolvable Paper Material (B-403)

Completely dissolves in warm water within 30 seconds, leaving no adhesive residue, eliminating labor required for label removal and allows for easy re-identification.

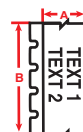

Figure 33



Figure	Catalog #	B#	Material	Color	Label Width A Inch (mm)	Roll Length B Feet (m)	Labels Per Roll	Rec. Ribbon
Fig. 33	M71C-750-403	B-403	Dissolvable Paper	White	0.750 (19.05)	50 (15.2)	1 roll (cont.)	M71-R4300
Fig. 33	M71C-1500-403	B-403	Dissolvable Paper	White	1.500 (38.1)	50 (15.2)	1 roll (cont.)	M71-R4300

Pre-Printed Calibration and Testing Labels (B-423, B-428 and B-483)

- **B-423 Polyester Material:** UL recognized for outdoor use on glass, thermoset polyester plastic and polyvinyl fluoride plastic.
- **B-428 Metallized Polyester Material:** For barcodes, alphanumerics and graphics that require nameplate-like quality
- **B-483 Gloss Polyester Material:** Permanent rubber-based adhesive for powder-coated and textured surfaces

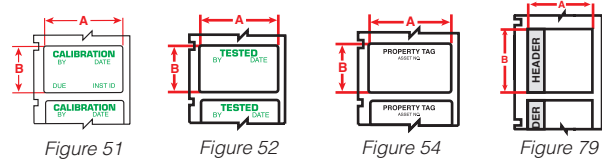

Portable Printers

Figure	Catalog #	B#	Material	Color	Label Width A Inch (mm)	Label Height B Inch (mm)	Labels Per Roll	Rec. Ribbon
B-423 Permanent Polyester								
Fig. 52	M71-30-423-TEST	B-423	Polyester	White	1.500 (38.1)	0.750 (19.1)	250	M71-R6000
B-428 Metallized Polyester								
Fig. 51	M71-30-428-CALI	B-428	Polyester	Light Gray	1.500 (38.1)	0.750 (19.1)	250	M71-R4300
Fig. 53	M71-35-428-PROP	B-428	Polyester	Light Gray	1.630 (41.4)	0.750 (19.1)	250	M71-R4300
B-483 Gloss Polyester								
Fig. 79	M71-38-483-CAUT	B-483	Polyester	White	4.000 (101.6)	1.900 (48.7)	100	M71-R6000
Fig. 79	M71-38-483-DANG	B-483	Polyester	White	4.000 (101.6)	1.900 (48.7)	100	M71-R6000
Fig. 79	M71-38-483-NOTI	B-483	Polyester	White	4.000 (101.6)	1.900 (48.7)	100	M71-R6000
Fig. 79	M71-38-483-WARN	B-483	Polyester	White	4.000 (101.6)	1.900 (48.7)	100	M71-R6000

Push-Button Style Raised Panel Labels (B-593)

Glossy, foam-backed polyester with permanent adhesive and solvent resistance makes them a great replacement for engraved tags. Ideal for external push buttons, switches and internal connection points. Total label thickness: 0.0256 in. (0.650 mm). RoHS compliant and UL approved.

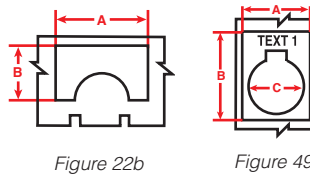

Figure	Catalog #	B#	Material	Color	Label Width A Inch (mm)	Label Height B Inch (mm)	Hole Diameter C Inch (mm)	Labels Per Roll	Rec. Ribbon
Fig. 22b	M71EP-180-593	B-593	Polyester	White	1.890 (48.01)	1.300 (33.02)	-	50	M71-R6000
Fig. 22b	M71EP-182-593	B-593	Polyester	White	2.400 (60.96)	1.900 (48.26)	-	50	M71-R6000
Fig. 49	M71EP-167-593	B-593	Polyester	White	1.200 (30.480)	1.500 (38.1)	0.890 (22.5)	100	M71-R6000
Fig. 49	M71EP-168-593	B-593	Polyester	White	1.200 (30.480)	1.900 (48.3)	0.890 (22.5)	100	M71-R6000
Fig. 49	M71EP-169-593	B-593	Polyester	White	1.800 (45.720)	1.800 (45.7)	1.200 (30.5)	100	M71-R6000
Fig. 49	M71EP-189-593	B-593	Polyester	White	1.800 (45.72)	2.400 (60.96)	0.445 (11.3)	50	M71-R6000
Fig. 49	M71EP-167-593-YL	B-593	Polyester	Yellow	1.200 (30.480)	1.500 (38.1)	0.890 (22.5)	100	M71-R6000
Fig. 49	M71EP-168-593-YL	B-593	Polyester	Yellow	1.200 (30.480)	1.900 (48.3)	0.890 (22.5)	100	M71-R6000
Fig. 49	M71EP-169-593-YL	B-593	Polyester	Yellow	1.800 (45.720)	1.800 (45.7)	1.200 (30.5)	100	M71-R6000
Fig. 49	M71EP-189-593-YL	B-593	Polyester	Yellow	1.800 (45.72)	2.400 (60.96)	0.445 (11.3)	50	M71-R6000
Fig. 49	M71EP-167-593-BK	B-593	Polyester	Black	1.200 (30.480)	1.500 (38.1)	0.890 (22.5)	100	M71-R4400-WT
Fig. 49	M71EP-168-593-BK	B-593	Polyester	Black	1.200 (30.480)	1.900 (48.3)	0.890 (22.5)	100	M71-R4400-WT
Fig. 49	M71EP-169-593-BK	B-593	Polyester	Black	1.800 (45.720)	1.800 (45.7)	1.200 (30.5)	100	M71-R4400-WT
Fig. 49	M71EP-189-593-BK	B-593	Polyester	Black	1.800 (45.72)	2.400 (60.96)	0.445 (11.3)	50	M71-R4400-WT
Fig. 49	M71EP-167-593-GN	B-593	Polyester	Green	1.200 (30.480)	1.500 (38.1)	0.890 (22.5)	100	M71-R4400-WT
Fig. 49	M71EP-168-593-GN	B-593	Polyester	Green	1.200 (30.480)	1.900 (48.3)	0.890 (22.5)	100	M71-R4400-WT
Fig. 49	M71EP-169-593-GN	B-593	Polyester	Green	1.800 (45.720)	1.800 (45.7)	1.200 (30.5)	100	M71-R4400-WT
Fig. 49	M71EP-189-593-GN	B-593	Polyester	Green	1.800 (45.72)	2.400 (60.96)	0.445 (11.3)	50	M71-R4400-WT
Fig. 49	M71EP-167-593-RD	B-593	Polyester	Red	1.200 (30.480)	1.500 (38.1)	0.890 (22.5)	100	M71-R4400-WT
Fig. 49	M71EP-168-593-RD	B-593	Polyester	Red	1.200 (30.480)	1.900 (48.3)	0.890 (22.5)	100	M71-R4400-WT
Fig. 49	M71EP-169-593-RD	B-593	Polyester	Red	1.800 (45.720)	1.800 (45.7)	1.200 (30.5)	100	M71-R4400-WT
Fig. 49	M71EP-189-593-RD	B-593	Polyester	Red	1.800 (45.72)	2.400 (60.96)	0.445 (11.3)	50	M71-R4400-WT

BMP71

Rectangular Raised Panel Labels (B-593)

Glossy, foam-backed polyester with permanent adhesive and solvent resistance makes them a great replacement for engraved tags. Ideal for external push buttons, switches and internal connection points. Total label thickness is 0.0256 in. (0.650 mm). RoHS compliant and UL approved.

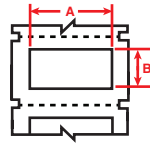

Figure 18

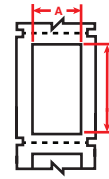

Figure 20



Figure	Catalog #	B#	Material	Color	Label Width A Inch (mm)	Label Height B Inch (mm)	Labels Per Roll	Rec. Ribbon
Fig. 18	M71EP-171-593	B-593	Polyester	White	1.060 (26.9)	0.490 (12.5)	200	M71-R6000
Fig. 18	M71EP-172-593	B-593	Polyester	White	1.770 (44.96)	0.590 (14.99)	100	M71-R6000
Fig. 20	M71EP-173-593	B-593	Polyester	White	1.000 (25.4)	2.000 (50.8)	100	M71-R6000
Fig. 20	M71EP-176-593	B-593	Polyester	White	1.000 (25.4)	3.000 (76.2)	50	M71-R6000
Fig. 20	M71EP-190-593	B-593	Polyester	White	1.900 (48.26)	3.000 (76.2)	50	M71-R6000
Fig. 20	M71EP-174-593	B-593	Polyester	White	1.000 (25.4)	4.000 (101.6)	50	M71-R6000
Fig. 20	M71EP-191-593	B-593	Polyester	White	1.900 (48.26)	4.000 (101.6)	25	M71-R6000
Fig. 20	M71EP-186-593	B-593	Polyester	White	1.000 (25.4)	6.000 (152.4)	25	M71-R6000
Fig. 20	M71EP-192-593	B-593	Polyester	White	1.900 (48.26)	6.000 (152.4)	25	M71-R6000
Fig. 18	M71EP-171-593-YL	B-593	Polyester	Yellow	1.060 (26.9)	0.490 (12.5)	200	M71-R6000
Fig. 18	M71EP-172-593-YL	B-593	Polyester	Yellow	1.770 (44.96)	0.590 (14.99)	100	M71-R6000
Fig. 20	M71EP-173-593-YL	B-593	Polyester	Yellow	1.000 (25.4)	2.000 (50.8)	100	M71-R6000
Fig. 20	M71EP-176-593-YL	B-593	Polyester	Yellow	1.000 (25.4)	3.000 (76.2)	50	M71-R6000
Fig. 20	M71EP-190-593-YL	B-593	Polyester	Yellow	1.900 (48.26)	3.000 (76.2)	50	M71-R6000
Fig. 20	M71EP-174-593-YL	B-593	Polyester	Yellow	1.000 (25.4)	4.000 (101.6)	50	M71-R6000
Fig. 20	M71EP-191-593-YL	B-593	Polyester	Yellow	1.900 (48.26)	4.000 (101.6)	25	M71-R6000
Fig. 20	M71EP-186-593-YL	B-593	Polyester	Yellow	1.000 (25.4)	6.000 (152.4)	25	M71-R6000
Fig. 20	M71EP-192-593-YL	B-593	Polyester	Yellow	1.900 (48.26)	6.000 (152.4)	25	M71-R4400-WT
Fig. 18	M71EP-171-593-BK	B-593	Polyester	Black	1.060 (26.9)	0.490 (12.5)	200	M71-R4400-WT
Fig. 18	M71EP-172-593-BK	B-593	Polyester	Black	1.770 (44.96)	0.590 (14.99)	100	M71-R4400-WT
Fig. 20	M71EP-173-593-BK	B-593	Polyester	Black	1.000 (25.4)	2.000 (50.8)	100	M71-R4400-WT
Fig. 20	M71EP-176-593-BK	B-593	Polyester	Black	1.000 (25.4)	3.000 (76.2)	50	M71-R4400-WT
Fig. 20	M71EP-190-593-BK	B-593	Polyester	Black	1.900 (48.26)	3.000 (76.2)	50	M71-R4400-WT
Fig. 20	M71EP-174-593-BK	B-593	Polyester	Black	1.000 (25.4)	4.000 (101.6)	50	M71-R4400-WT
Fig. 20	M71EP-191-593-BK	B-593	Polyester	Black	1.900 (48.26)	4.000 (101.6)	25	M71-R4400-WT
Fig. 20	M71EP-186-593-BK	B-593	Polyester	Black	1.000 (25.4)	6.000 (152.4)	25	M71-R4400-WT
Fig. 20	M71EP-192-593-BK	B-593	Polyester	Black	1.900 (48.26)	6.000 (152.4)	25	M71-R4400-WT
Fig. 18	M71EP-171-593-GN	B-593	Polyester	Green	1.060 (26.9)	0.490 (12.5)	200	M71-R4400-WT
Fig. 18	M71EP-172-593-GN	B-593	Polyester	Green	1.770 (44.96)	0.590 (14.99)	100	M71-R4400-WT
Fig. 20	M71EP-173-593-GN	B-593	Polyester	Green	1.000 (25.4)	2.000 (50.8)	100	M71-R4400-WT
Fig. 20	M71EP-176-593-GN	B-593	Polyester	Green	1.000 (25.4)	3.000 (76.2)	50	M71-R4400-WT
Fig. 20	M71EP-190-593-GN	B-593	Polyester	Green	1.900 (48.26)	3.000 (76.2)	50	M71-R4400-WT
Fig. 20	M71EP-174-593-GN	B-593	Polyester	Green	1.000 (25.4)	4.000 (101.6)	50	M71-R4400-WT
Fig. 20	M71EP-191-593-GN	B-593	Polyester	Green	1.900 (48.26)	4.000 (101.6)	25	M71-R4400-WT
Fig. 20	M71EP-186-593-GN	B-593	Polyester	Green	1.000 (25.4)	6.000 (152.4)	25	M71-R4400-WT
Fig. 20	M71EP-192-593-GN	B-593	Polyester	Green	1.900 (48.26)	6.000 (152.4)	25	M71-R4400-WT
Fig. 18	M71EP-171-593-RD	B-593	Polyester	Red	1.060 (26.9)	0.490 (12.5)	200	M71-R4400-WT
Fig. 18	M71EP-172-593-RD	B-593	Polyester	Red	1.770 (44.96)	0.590 (14.99)	100	M71-R4400-WT
Fig. 20	M71EP-173-593-RD	B-593	Polyester	Red	1.000 (25.4)	2.000 (50.8)	100	M71-R4400-WT
Fig. 20	M71EP-176-593-RD	B-593	Polyester	Red	1.000 (25.4)	3.000 (76.2)	50	M71-R4400-WT
Fig. 20	M71EP-190-593-RD	B-593	Polyester	Red	1.900 (48.26)	3.000 (76.2)	50	M71-R4400-WT
Fig. 20	M71EP-174-593-RD	B-593	Polyester	Red	1.000 (25.4)	4.000 (101.6)	50	M71-R4400-WT
Fig. 20	M71EP-191-593-RD	B-593	Polyester	Red	1.900 (48.26)	4.000 (101.6)	25	M71-R4400-WT
Fig. 20	M71EP-186-593-RD	B-593	Polyester	Red	1.000 (25.4)	6.000 (152.4)	25	M71-R4400-WT
Fig. 20	M71EP-192-593-RD	B-593	Polyester	Red	1.900 (48.26)	6.000 (152.4)	25	M71-R4400-WT
Fig. 18	M71EP-171-593-SL	B-593	Polyester	Silver	1.060 (26.9)	0.490 (12.5)	200	M71-R6000
Fig. 18	M71EP-172-593-SL	B-593	Polyester	Silver	1.770 (44.96)	0.590 (14.99)	100	M71-R6000
Fig. 20	M71EP-173-593-SL	B-593	Polyester	Silver	1.000 (25.4)	2.000 (50.8)	100	M71-R6000
Fig. 20	M71EP-190-593-SL	B-593	Polyester	Silver	1.900 (48.26)	3.000 (76.2)	50	M71-R6000
Fig. 20	M71EP-174-593-SL	B-593	Polyester	Silver	1.000 (25.4)	4.000 (101.6)	50	M71-R6000
Fig. 20	M71EP-191-593-SL	B-593	Polyester	Silver	1.900 (48.26)	4.000 (101.6)	25	M71-R6000
Fig. 20	M71EP-186-593-SL	B-593	Polyester	Silver	1.000 (25.4)	6.000 (152.4)	25	M71-R6000
Fig. 20	M71EP-192-593-SL	B-593	Polyester	Silver	1.900 (48.26)	6.000 (152.4)	25	M71-R6000

Patch Panel Strips (B-412 and B-422)

- **B-412 Non-Adhesive Polypropylene Strips:**
Designed for high legibility and tensile strength
- **B-422 Polyester Material:** Permanent aggressive adhesive, good for powder-coated and textured surfaces. Best on flat surfaces. Temp. range: -40°F to 212°F (-40°C to 100°C). UL recognized.

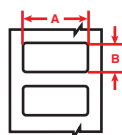

Figure 2



Figure 33



Figure	Catalog #	B#	Material	Color	Label Width A Inch (mm)	Label Height B Inch (mm)	Labels Per Roll	Rec. Ribbon
B-412 Non-Adhesive Polypropylene Material								
Fig. 33	M71C-230-412	B-412	Polyethylene Non-Adhesive Strip	White	0.230 (5.8)	50 ft. (15.2 m)	1 roll (cont.)	M71-R6200
Fig. 33	M71C-375-412	B-412	Polyethylene Non-Adhesive Strip	White	0.375 (9.5)	50 ft. (15.2 m)	1 roll (cont.)	M71-R6200
Fig. 33	M71C-475-412	B-412	Polyethylene Non-Adhesive Strip	White	0.475 (12.1)	50 ft. (15.2 m)	1 roll (cont.)	M71-R6200
Fig. 33	M71C-500-412	B-412	Polyethylene Non-Adhesive Strip	White	0.500 (12.7)	50 ft. (15.2 m)	1 roll (cont.)	M71-R6200
Fig. 33	M71C-625-412	B-412	Polyethylene Non-Adhesive Strip	White	0.625 (15.9)	50 ft. (15.2 m)	1 roll (cont.)	M71-R6200
Fig. 33	M71C-785-412	B-412	Polyethylene Non-Adhesive Strip	White	0.785 (19.9)	50 ft. (15.2 m)	1 roll (cont.)	M71-R6200
B-422 Permanent Adhesive Polyester Material								
Fig. 33	M71C-375-422	B-422	Polyester Adhesive Strip	White	0.375 (9.5)	50 ft. (15.2 m)	1 roll (cont.)	M71-R6000
Fig. 33	M71C-475-422	B-422	Polyester Adhesive Strip	White	0.475 (12.1)	50 ft. (15.2 m)	1 roll (cont.)	M71-R6000
Fig. 33	M71C-500-422	B-422	Polyester Adhesive Strip	White	0.500 (12.7)	50 ft. (15.2 m)	1 roll (cont.)	M71-R6000
Fig. 33	M71C-625-422	B-422	Polyester Adhesive Strip	White	0.625 (15.9)	50 ft. (15.2 m)	1 roll (cont.)	M71-R6000
Fig. 33	M71C-1000-422	B-422	Polyester Adhesive Strip	White	1.000 (25.4)	50 ft. (15.2 m)	1 roll (cont.)	M71-R6000
Fig. 33	M71C-1900-422	B-422	Polyester Adhesive Strip	White	1.900 (48.3)	50 ft. (15.2 m)	1 roll (cont.)	M71-R6000
Fig. 2	M71-45-422	B-422	Polyester Individual Labels	White	1.500 (38.1)	0.375 (9.5)	500	M71-R6000
Fig. 2	M71-30-422	B-422	Polyester Individual Labels	White	1.500 (38.1)	0.750 (19.1)	250	M71-R6000
Fig. 2	BM71-20-422	B-422	Polyester Individual Labels	White	2.000 (50.8)	1.000 (25.4)	1,000	M71-R6000
Fig. 2	M71-37-422	B-422	Polyester Individual Labels	White	3.000 (76.2)	1.900 (48.3)	100	M71-R6000

Faceplate, Outlet and Port Labels (B-412, B-423 and B-595)

- **B-412 Non-Adhesive Polypropylene Tag Material:**
Designed for high legibility and tensile strength.
- **B-423 Polyester Material:** White glossy polyester with aggressive adhesive
- **B-595 Indoor / Outdoor Vinyl Material:**
Aggressive permanent adhesive, very pliable, conforms to rough surfaces, excellent resistance to oils, detergents, dirt and many solvents

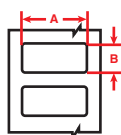

Figure 2

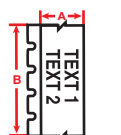

Figure 33

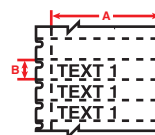

Figure 55



Figure	Catalog #	B#	Material	Color	Label Width A Inch (mm)	Label Height B Inch (mm)	Labels Per Roll	Rec. Ribbon
B-412 Non-Adhesive Polypropylene								
Fig. 55	BM71-40-412	B-412	Non-adhesive Strip	White	1.938 (49.2)	0.375 (9.5)	5,000	M71-R6200
Fig. 55	M71-40-412	B-412	Non-adhesive Strip	White	1.938 (49.2)	0.375 (9.5)	750	M71-R6200
B-423 Permanent Polyester								
Fig. 2	M71-7-423	B-423	Polyester	White	0.500 (12.700)	0.500 (12.700)	500	M71-R6000
Fig. 33	M71C-500-423	B-423	Polyester Strip	White	0.500 (12.700)	50 ft. (15.24 m)	1 roll (cont.)	M71-R6000
Fig. 2	M71-16-423	B-423	Polyester Individual Labels	White	1.000 (25.400)	0.375 (9.530)	500	M71-R6000
Fig. 2	M71-17-423	B-423	Polyester Individual Labels	White	1.000 (25.400)	0.500 (12.700)	500	M71-R6000
Fig. 2	M71-29-423	B-423	Polyester Individual Labels	White	1.500 (38.100)	0.500 (12.700)	500	M71-R6000
B-595 Indoor / Outdoor Vinyl								
Fig. 33	M71C-500-595-WT	B-595	Vinyl Strip	White	0.500 (12.7)	50 ft. (15.2 m)	1 roll (cont.)	M71-R6000

Non-Adhesive Tags (B-109 and B-145)

- **B-109 Polyethylene Tags:** Multipurpose tag that can be used for a variety of applications including identification of multi-conductor cables, inventory, equipment, lockout and work-in-progress. Extremely tear resistant and superior cold-weather tag
- **B-145 Polyethylene and B-145FR Fire Retardant Polyethylene Tags:** Hang tags are made of 9.5 mil cross laminated polyethylene film with a thermal transfer printable topcoat. Used for a variety of tag applications including on multiconductor cables and equipment

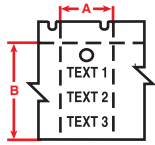

Figure 45

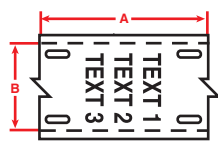

Figure 56

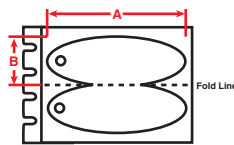

Figure 50



Figure	Catalog #	B#	Material	Color	Label Width A Inch (mm)	Label Height B Inch (mm)	Labels Per Roll	Rec. Ribbon
B-109 Polyethylene Tags								
Fig. 45	M71-36-109	B-109	Polyethylene	White	1.125 (28.6)	1.750 (44.5)	250	M71-R4300
Fig. 56	M71-12-109	B-109	Polyethylene	White	3.000 (76.2)	0.750 (19.1)	100	M71-R4300
Fig. 56	BM71-12-109	B-109	Polyethylene	White	3.000 (76.2)	0.750 (19.1)	1,000	M71-R4300
B-145 Polyethylene Tags								
Fig. 50	BM71-111-145-GY	B-145	Polyethylene	Light Gray	1.206 (30.6)	0.758 (19.3)	1,000	M71-R6000
Fig. 50	M71-111-145-GY	B-145	Polyethylene	Light Gray	1.206 (30.6)	0.758 (19.3)	100	M71-R6000
Fig. 50	BM71-110-145-GY	B-145	Polyethylene	Light Gray	1.750 (44.5)	1.000 (25.4)	1,000	M71-R6000
Fig. 50	M71-110-145-GY	B-145	Polyethylene	Light Gray	1.750 (44.5)	1.000 (25.4)	100	M71-R6000
B-145FR Fire Retardant Polyethylene Tags								
Fig. 50	M71-111-145FR-GY	B-145FR	Polyethylene	Light Gray	1.206 (30.6)	0.758 (19.3)	100	M71-R6000
Fig. 50	M71-110-145FR-GY	B-145FR	Polyethylene	Light Gray	1.750 (44.5)	1.000 (25.4)	100	M71-R6000

Fiber Optic Cable Flags (B-425)

Flags allows more legible information on smaller diameter wires and permits you to handle and view labels without touching the wires. Matte white polypropylene with excellent solvent resistance and print performance; not recommended for long-term outdoor use.

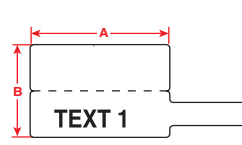

Figure 47

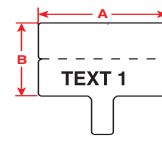

Figure 48



Figure	Catalog #	B#	Material	Color	Label Width A Inch (mm)	Label Height B Inch (mm)	Labels Per Roll	Rec. Ribbon
Fig. 47	M71FP-1-425	B-425	Polypropylene	White	1.180 (30.0)	0.788 (20.0)	250	M71-R4300
Fig. 48	M71FT-1-425	B-425	Polypropylene	White	1.180 (30.0)	0.788 (20.0)	250	M71-R4300
Fig. 47	M71FP-2-425	B-425	Polypropylene	White	1.750 (44.5)	1.000 (25.4)	100	M71-R4300

Terminal Block Repositionable Adhesive Strips (B-498)

The adhesive and cloth backing offers excellent holding power, yet allows for clean removal and repositioning if necessary. Temp. range -40° F to 175° F (-40° C to 70° C). UL recognized.



Figure 33

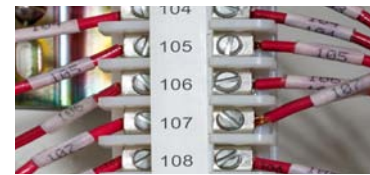

Figure	Catalog #	B#	Material	Color	Label Width A Inch (mm)	Roll Length B Feet (m)	Labels Per Roll	Rec. Ribbon
Fig. 33	M71C-240-498	B-498	Vinyl Cloth	White	0.240 (6.1)	30 (9.1)	1 roll (cont.)	M71-R6200
Fig. 33	M71C-318-498	B-498	Vinyl Cloth	White	0.318 (8.1)	30 (9.1)	1 roll (cont.)	M71-R6200
Fig. 33	M71C-375-498	B-498	Vinyl Cloth	White	0.375 (9.5)	30 (9.1)	1 roll (cont.)	M71-R6200
Fig. 33	BM71C-240-498	B-498	Vinyl Cloth	White	0.240 (6.1)	275 (83.8)	1 roll (cont.)	M71-R6200
Fig. 33	BM71C-318-498	B-498	Vinyl Cloth	White	0.318 (8.1)	275 (83.8)	1 roll (cont.)	M71-R6200
Fig. 33	BM71C-375-498	B-498	Vinyl Cloth	White	0.375 (9.5)	275 (83.8)	1 roll (cont.)	M71-R6200

Adhesive Cloth Wire and Cable Labels (B-498 and B-499)

- **B-498 Repositionable Vinyl Cloth:** Adhesive and cloth backing offers excellent holding power, yet allow for removal and repositioning. Temp. range -40° F to 175° F (-40° C to 70° C). UL recognized.
- **B-499 Permanent Nylon Cloth:** Durable industrial strength and designed to conform to curved surfaces

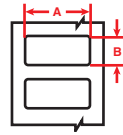

Figure 2



Figure 33

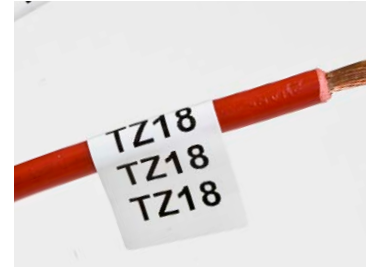

Figure	Catalog #	Material	Color	Approx. Wire Gauge	Label Width A Inch (mm)	Label Height B Inch (mm)	Labels Per Roll	Rec. Ribbon
B-498 Repositionable Vinyl Cloth Labels								
Fig. 2	M71-7-498	B-498	White	16 to 10	0.500 (12.7)	0.500 (12.7)	500	M71-R6200
Fig. 2	M71-17-498	B-498	White	16 to 10	1.000 (25.4)	0.500 (12.7)	500	M71-R6200
Fig. 2	M71-10-498	B-498	White	16 to 10	0.250 (6.4)	0.750 (19.1)	750	M71-R6200
Fig. 2	BM71-11-498	B-498	White	16 to 10	0.500 (12.7)	0.750 (19.1)	5,000	M71-R6200
Fig. 2	M71-11-498	B-498	White	16 to 10	0.500 (12.7)	0.750 (19.1)	500	M71-R6200
Fig. 2	M71-16-498	B-498	White	12 to 10	0.375 (9.5)	1.000 (25.4)	500	M71-R6200
Fig. 2	BM71-18-498	B-498	White	12 to 10	0.750 (19.1)	1.000 (25.4)	2,500	M71-R6200
Fig. 2	M71-18-498	B-498	White	12 to 10	0.750 (19.1)	1.000 (25.4)	250	M71-R6200
Fig. 2	BM71-19-498	B-498	White	12 to 10	1.000 (25.4)	1.000 (25.4)	2,500	M71-R6200
Fig. 2	M71-19-498	B-498	White	12 to 10	1.000 (25.4)	1.000 (25.4)	250	M71-R6200
Fig. 2	BM71-29-498	B-498	White	10 to 4	0.500 (12.7)	1.500 (38.1)	5,000	M71-R6200
Fig. 2	M71-29-498	B-498	White	10 to 4	0.500 (12.7)	1.500 (38.1)	500	M71-R6200
Fig. 2	M71-30-498	B-498	White	10 to 4	0.750 (19.1)	1.500 (38.1)	250	M71-R6200
Fig. 2	M71-31-498	B-498	White	10 to 4	1.000 (25.4)	1.500 (38.1)	250	M71-R6200
Fig. 2	M71-32-498	B-498	White	10 to 4	1.500 (38.1)	1.500 (38.1)	250	M71-R6200
Fig. 2	M71-21-498	B-498	White	Cables	1.000 (25.4)	2.500 (63.5)	100	M71-R6200
Fig. 2	M71-33-498	B-498	White	Cables	1.500 (38.1)	4.000 (101.6)	100	M71-R6200
Fig. 33	M71C-500-498	B-498	White	-	0.500 (12.7)	30 ft. (9.1 m)	1 roll (cont.)	M71-R6200
Fig. 33	M71C-1000-498	B-498	White	-	1.000 (25.4)	30 ft. (9.1 m)	1 roll (cont.)	M71-R6200
Fig. 33	M71C-1900-498	B-498	White	-	1.900 (48.3)	30 ft. (9.1 m)	1 roll (cont.)	M71-R6200
B-499 Nylon Cloth Labels								
Fig. 2	M71-7-499	B-499	White	16 to 10	0.500 (12.7)	0.500 (12.7)	500	M71-R4300
Fig. 2	BM71-11-499	B-499	White	16 to 10	0.500 (12.7)	0.750 (19.1)	5,000	M71-R4300
Fig. 2	M71-11-499	B-499	White	16 to 10	0.500 (12.7)	0.750 (19.1)	500	M71-R4300
Fig. 2	M71-16-499	B-499	White	12 to 10	0.375 (9.5)	1.000 (25.4)	500	M71-R4300
Fig. 2	M71-18-499	B-499	White	12 to 10	0.750 (19.1)	1.000 (25.4)	250	M71-R4300
Fig. 2	M71-19-499	B-499	White	12 to 10	1.000 (25.4)	1.000 (25.4)	250	M71-R4300
Fig. 2	M71-78-499	B-499	White	12 to 10	1.900 (48.3)	1.000 (25.4)	250	M71-R4300
Fig. 2	M71-28-499	B-499	White	10 to 4	0.250 (6.4)	1.500 (38.1)	750	M71-R4300
Fig. 2	M71-29-499	B-499	White	10 to 4	0.500 (12.7)	1.500 (38.1)	500	M71-R4300
Fig. 2	M71-30-499	B-499	White	10 to 4	0.750 (19.1)	1.500 (38.1)	250	M71-R4300
Fig. 2	M71-31-499	B-499	White	10 to 4	1.000 (25.4)	1.500 (38.1)	250	M71-R4300
Fig. 2	M71-21-499	B-499	White	Cables	1.000 (25.4)	2.500 (63.5)	100	M71-R4300
Fig. 33	M71C-500-499	B-499	White	-	0.500 (12.7)	30 ft. (9.1 m)	1 roll (cont.)	M71-R4300
Fig. 33	M71C-1000-499	B-499	White	-	1.000 (25.4)	30 ft. (9.1 m)	1 roll (cont.)	M71-R4300
Fig. 33	M71C-1900-499	B-499	White	-	1.900 (48.3)	30 ft. (9.1 m)	1 roll (cont.)	M71-R4300

High Temp Wire and Cable Labels (B-437, B-472)

- **B-437 Polyvinylfluoride Material:** Permanent acrylic adhesive and has excellent resistance to water, oil and other common fluids. Meets the requirements of MIL-M-87958. UL approved.
- **B-472 Polyimide Material:** Specifically designed to self-extinguish and prevent flames from propagating

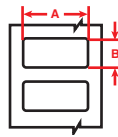

Figure 2



Figure 33



Figure	Catalog #	B#	Material	Color	Approx. Wire Gauge	Label Width A Inch (mm)	Label Height B Inch (mm)	Labels Per Roll	Rec. Ribbon
B-437 Polyvinylfluoride									
Fig. 2	M71-10-437	B-437	Polyvinylfluoride	White	16 to 10	0.250 (6.4)	0.750 (25.4)	750	M71-R4300
Fig. 2	M71-15-437	B-437	Polyvinylfluoride	White	12 to 10	0.275 (7.0)	1.000 (25.4)	750	M71-R4300
Fig. 2	M71-29-437	B-437	Polyvinylfluoride	White	10 to 4	0.500 (12.7)	1.500 (19.1)	500	M71-R4300
B-472 Polyimide									
Fig. 2	M71-10-472	B-472	Polyimide	White	16 to 10	0.250 (6.4)	0.750 (25.4)	750	M71-R4300
Fig. 2	M71-30-472	B-472	Polyimide	White	16 to 10	1.500 (38.1)	0.750 (38.1)	250	M71-R4300
Fig. 2	M71-15-472	B-472	Polyimide	White	12 to 10	0.275 (7.0)	1.000 (25.4)	750	M71-R4300
Fig. 2	M71-17-472	B-472	Polyimide	White	12 to 10	0.500 (12.7)	1.000 (25.4)	500	M71-R4300
Fig. 2	M71-19-472	B-472	Polyimide	White	12 to 10	1.000 (25.4)	1.000 (25.4)	250	M71-R4300
Fig. 2	M71-21-472	B-472	Polyimide	White	12 to 10	2.500 (63.5)	1.000 (38.1)	100	M71-R4300
Fig. 2	M71-29-472	B-472	Polyimide	White	10 to 4	0.500 (12.7)	1.500 (19.1)	500	M71-R4300
Fig. 2	M71-31-472	B-472	Polyimide	White	10 to 4	1.000 (25.4)	1.500 (16.5)	250	M71-R4300
Fig. 33	M71C-1000-472	B-472	Polyimide	White	-	1.000 (25.4)	50 ft. (15.2 m)	1 roll (cont.)	M71-R4300
Fig. 33	M71C-1500-472	B-472	Polyimide	White	-	1.500 (38.1)	50 ft. (15.2 m)	1 roll (cont.)	M71-R4300
Fig. 33	M71C-2000-472	B-472	Polyimide	White	-	2.000 (50.8)	50 ft. (15.2 m)	1 roll (cont.)	M71-R4300
Fig. 33	M71C-1000-472-YL	B-472	Polyimide	Yellow	-	1.000 (38.1)	50 ft. (15.2 m)	1 roll (cont.)	M71-R4300
Fig. 33	M71C-1500-472-YL	B-472	Polyimide	Yellow	-	1.500 (50.8)	50 ft. (15.2 m)	1 roll (cont.)	M71-R4300
Fig. 33	M71C-2000-472-YL	B-472	Polyimide	Yellow	-	2.000 (38.1)	50 ft. (15.2 m)	1 roll (cont.)	M71-R4300

Self-Extinguishing Polyvinylfluoride Labels (B-642)

Clear polyvinylfluoride film with a white printable zone and a translucent overlaminating area offers excellent flexibility for wrapping around small diameter wires. Material features self-extinguishing properties and is solvent resistant.

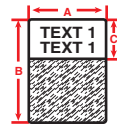

Figure 32



Figure	Catalog #	B#	Material	Color	Approx. Wire Gauge	Label Width A Inch (mm)	Label Height B Inch (mm)	Print-On Height C Inch (mm)	Labels Per Roll	Rec. Ribbon
Fig. 32	M71-19-642	B-642	Polyvinylfluoride	White	12 to 10	1.000 (25.400)	1.000 (25.400)	0.375 (9.530)	250	M71-R4300
Fig. 32	M71-31-642	B-642	Polyvinylfluoride	White	10 to 4	1.000 (25.400)	1.500 (38.100)	0.500 (12.700)	250	M71-R6200
Fig. 32	M71-21-642	B-642	Polyvinylfluoride	White	25 Pair Copper	1.000 (25.400)	2.500 (63.500)	0.750 (38.1)	100	M71-R6200

Self-Laminating Vinyl Wire and Cable Labels (B-427)

Labels feature a clear, non-printable area that wraps around print-on area to protect text. Vinyl material offers superior resistance to solvents, oil, grease, dirt and water. Temp. range -40° F to 158° F (-40° C to 70° C), UL recognized.

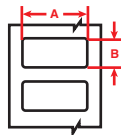

Figure 2

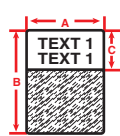

Figure 32

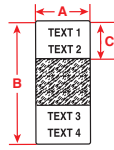

Figure 43

Figure	Catalog #	B#	Color	Approx. Wire Gauge	Label Width A Inch (mm)	Label Height B Inch (mm)	Print-On Height C Inch (mm)	Labels Per Roll	Rec. Ribbon
Fig. 32	M71-10-427	B-427	White	16 to 10	0.250 (6.350)	0.750 (19.050)	0.375 (9.530)	750	M71-R4300
Fig. 32	M71-11-427	B-427	White	16 to 10	0.500 (12.700)	0.750 (19.050)	0.375 (9.530)	500	M71-R4300
Fig. 32	BM71-11-427	B-427	White	16 to 10	0.500 (12.700)	0.750 (19.050)	0.375 (9.530)	5,000	M71-R4300
Fig. 32	M71-96-427	B-427	White	16 to 10	1.000 (25.400)	0.750 (19.050)	0.375 (9.530)	250	M71-R4300
Fig. 2	M71-30-427-AW	B-427	White	10 to 4	1.500 (38.100)	0.750 (19.050)	-	250	M71-R4300
Fig. 32	M71-17-427	B-427	White	12 to 10	0.500 (12.700)	1.000 (25.400)	0.375 (9.530)	500	M71-R4300
Fig. 32	BM71-17-427	B-427	White	12 to 10	0.500 (12.700)	1.000 (25.400)	0.375 (9.530)	5,000	M71-R4300
Fig. 32	M71-18-427	B-427	White	10 to 4	0.750 (19.050)	1.000 (25.400)	0.375 (9.530)	250	M71-R4300
Fig. 32	BM71-18-427	B-427	White	10 to 4	0.750 (19.050)	1.000 (25.400)	0.375 (9.530)	2,500	M71-R4300
Fig. 32	M71-19-427	B-427	White	12 to 10	1.000 (25.400)	1.000 (25.400)	0.375 (9.530)	250	M71-R4300
Fig. 32	BM71-19-427	B-427	White	12 to 10	1.000 (25.400)	1.000 (25.400)	0.375 (9.530)	2,500	M71-R4300
Fig. 32	M71-104-427	B-427	White	12 to 10	1.500 (38.100)	1.000 (25.400)	0.375 (9.530)	250	M71-R4300
Fig. 32	M71-103-427	B-427	White	10 to 4	1.000 (25.400)	1.250 (31.750)	0.500 (12.700)	250	M71-R4300
Fig. 32	M71-28-427	B-427	White	10 to 4	0.250 (6.350)	1.500 (38.100)	0.500 (12.700)	750	M71-R4300
Fig. 32	M71-29-427	B-427	White	10 to 4	0.500 (12.700)	1.500 (38.100)	0.500 (12.700)	500	M71-R4300
Fig. 32	BM71-29-427	B-427	White	10 to 4	0.500 (12.700)	1.500 (38.100)	0.500 (12.700)	5,000	M71-R4300
Fig. 32	M71-30-427	B-427	White	10 to 4	0.750 (19.050)	1.500 (38.100)	0.500 (12.700)	250	M71-R4300
Fig. 32	BM71-30-427	B-427	White	10 to 4	0.750 (19.050)	1.500 (38.100)	0.500 (12.700)	2,500	M71-R4300
Fig. 32	M71-31-427	B-427	White	10 to 4	1.000 (25.400)	1.500 (38.100)	0.500 (12.700)	250	M71-R4300
Fig. 32	BM71-31-427	B-427	White	10 to 4	1.000 (25.400)	1.500 (38.100)	0.500 (12.700)	2,500	M71-R4300
Fig. 32	M71-32-427	B-427	White	10 to 4	1.500 (38.100)	1.500 (38.100)	0.500 (12.700)	250	M71-R4300
Fig. 32	BM71-32-427	B-427	White	10 to 4	1.500 (38.100)	1.500 (38.100)	0.500 (12.700)	1,000	M71-R4300
Fig. 32	M71-88-427	B-427	White	10 to 4	1.750 (44.450)	1.500 (38.100)	0.500 (12.700)	250	M71-R4300
Fig. 32	M71-107-427	B-427	White	10 to 4	2.000 (50.800)	1.500 (38.100)	0.500 (12.700)	100	M71-R4300
Fig. 32	BM71-107-427	B-427	White	10 to 4	2.000 (50.800)	1.500 (38.100)	0.500 (12.700)	1,000	M71-R4300
Fig. 32	M71-21-427	B-427	White	Cables	1.000 (25.400)	2.500 (63.500)	0.750 (19.050)	100	M71-R4300
Fig. 32	BM71-21-427	B-427	White	Cables	1.000 (25.400)	2.500 (63.500)	0.750 (19.050)	1,000	M71-R4300
Fig. 32	M71-66-427	B-427	White	Cables	1.938 (49.230)	3.150 (80.000)	1.000 (25.400)	100	M71-R4300
Fig. 43	M71-64-427	B-427	White	Cables	1.000 (25.400)	3.375 (85.730)	1.125 (28.580)	100	M71-R4300
Fig. 43	BM71-64-427	B-427	White	Cables	1.000 (25.400)	3.375 (85.730)	1.125 (28.580)	1,000	M71-R4300
Fig. 32	M71-23-427	B-427	White	Cables	1.000 (25.400)	4.000 (101.600)	1.000 (25.400)	100	M71-R4300
Fig. 32	BM71-23-427	B-427	White	Cables	1.000 (25.400)	4.000 (101.600)	1.000 (25.400)	1,000	M71-R4300
Fig. 32	M71-109-427	B-427	White	Cables	1.500 (38.100)	4.000 (101.600)	1.500 (38.100)	100	M71-R4300
Fig. 32	M71-33-427	B-427	White	Cables	1.500 (38.100)	4.000 (101.600)	1.000 (25.400)	100	M71-R4300
Fig. 32	BM71-109-427	B-427	White	Cables	1.500 (38.100)	4.000 (101.600)	1.500 (38.100)	500	M71-R4300
Fig. 32	BM71-33-427	B-427	White	Cables	1.500 (38.100)	4.000 (101.600)	1.000 (25.400)	500	M71-R4300
Fig. 32	M71-34-427	B-427	White	Cables	1.500 (38.100)	6.000 (152.400)	1.500 (38.100)	50	M71-R4300
Fig. 32	BM71-34-427	B-427	White	Cables	1.500 (38.100)	6.000 (152.400)	1.500 (38.100)	500	M71-R4300
Fig. 32	M71-19-427-YL	B-427	Yellow	12 to 10	1.000 (25.400)	1.000 (25.400)	0.375 (9.530)	250	M71-R4300
Fig. 32	M71-31-427-YL	B-427	Yellow	10 to 4	1.000 (25.400)	1.500 (38.100)	0.500 (12.700)	250	M71-R4300
Fig. 32	M71-32-427-YL	B-427	Yellow	10 to 4	1.500 (38.100)	1.500 (38.100)	0.500 (12.700)	250	M71-R4300
Fig. 32	M71-21-427-YL	B-427	Yellow	Cables	1.000 (25.400)	2.500 (63.500)	0.750 (19.050)	100	M71-R4300
Fig. 32	M71-33-427-YL	B-427	Yellow	Cables	1.500 (38.100)	4.000 (101.600)	1.000 (25.400)	100	M71-R4300
Fig. 32	M71-30-427-BL	B-427	Blue	10 to 4	0.750 (19.050)	1.500 (38.100)	0.500 (12.700)	250	M71-R4300
Fig. 32	M71-30-427-PL	B-427	Purple	10 to 4	0.750 (19.050)	1.500 (38.100)	0.500 (12.700)	250	M71-R4300
Fig. 32	M71-31-427-GN	B-427	Green	10 to 4	1.000 (25.400)	1.500 (38.100)	0.500 (12.700)	250	M71-R4300
Fig. 32	M71-30-427-RD	B-427	Red	10 to 4	0.750 (19.050)	1.500 (38.100)	0.500 (12.700)	250	M71-R4300
Fig. 32	M71-31-427-RD	B-427	Red	10 to 4	1.000 (25.400)	1.500 (38.100)	0.500 (12.700)	250	M71-R4300

PermaSleeve[®] PS Polyolefin Wire Markers (B-342)

Military / industrial grade sleeves offer the ultimate in marker durability, permanence and aesthetic appearance. 3:1 heat-shrinkable markers fit snugly around wires, are fade-resistant and flame-retardant. Temp range: -67° F to 275° F (-55° C to 130° C). RoHS compliant and UL recognized.

Meets specifications:

- SSAE-AS-23053/5
- SAE-AS-81531

Tested per:

- ASTM E162
- ASTM E662
- MIL-STD-202

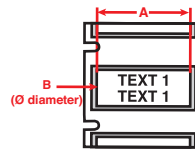

Figure 44

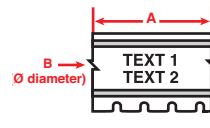

Figure 58



Figure	Catalog #	Color	Approx. Wire Gauge	Wire Diameter Range Inch (mm)	Supplied Diameter B Inch (mm)	Recovered Diameter Inch (mm)	Sleeve Width A Inch (mm)	Sleeves Per Row	Sleeves Per Roll	Rec. Ribbon
1.00 inch sleeve width (dimension A):										
Fig. 44	* BM71-94-1-342	White	28 to 20	0.023-0.080 (0.6-2.0)	0.094 (2.4)	0.024 (0.6)	1.000 (25.4)	1	1,000	M71-R4300
Fig. 44	* M71-94-1-342	White	28 to 20	0.023-0.080 (0.6-2.0)	0.094 (2.4)	0.024 (0.6)	1.000 (25.4)	1	100	M71-R4300
Fig. 44	* BM71-125-1-342	White	22 to 16	0.046-0.110 (1.2-2.8)	0.125 (3.2)	0.047 (1.2)	1.000 (25.4)	1	1,000	M71-R4300
Fig. 44	* M71-125-1-342	White	22 to 16	0.046-0.110 (1.2-2.8)	0.125 (3.2)	0.047 (1.2)	1.000 (25.4)	1	100	M71-R4300
Fig. 44	* BM71-187-1-342	White	20 to 10	0.062-0.150 (1.6-3.8)	0.187 (4.7)	0.062 (1.6)	1.000 (25.4)	1	1,000	M71-R4300
Fig. 44	* M71-187-1-342	White	20 to 10	0.062-0.150 (1.6-3.8)	0.187 (4.7)	0.062 (1.6)	1.000 (25.4)	1	100	M71-R4300
Fig. 44	* BM71-250-1-342	White	16 to 8	0.094-0.215 (2.4-5.5)	0.250 (6.4)	0.093 (2.4)	1.000 (25.4)	1	1,000	M71-R4300
Fig. 44	* M71-250-1-342	White	16 to 8	0.094-0.215 (2.4-5.5)	0.250 (6.4)	0.093 (2.4)	1.000 (25.4)	1	100	M71-R4300
Fig. 44	* BM71-375-1-342	White	12 to 4	0.125-0.320 (3.2-8.1)	0.375 (9.5)	0.125 (3.1)	1.000 (25.4)	1	1,000	M71-R4300
Fig. 44	* M71-375-1-342	White	12 to 4	0.125-0.320 (3.2-8.1)	0.375 (9.5)	0.125 (3.1)	1.000 (25.4)	1	100	M71-R4300
Fig. 44	* BM71-500-1-342	White	8 to 1	0.187-0.450 (4.8-11.4)	0.500 (12.7)	0.187 (4.7)	1.000 (25.4)	1	1,000	M71-R4300
Fig. 44	* M71-500-1-342	White	8 to 1	0.187-0.450 (4.8-11.4)	0.500 (12.7)	0.187 (4.7)	1.000 (25.4)	1	100	M71-R4300
Fig. 44	* M71-1000-1-342	White	2 to 0.950 dia.	0.333-0.950 (8.5-24.1)	1.000 (25.4)	0.375 (9.5)	1.000 (25.4)	1	50	M71-R4300
Fig. 44	* M71-94-1-342YL	Yellow	28 to 20	0.023-0.080 (0.6-2.0)	0.094 (2.4)	0.024 (0.6)	1.000 (25.4)	1	100	M71-R4300
Fig. 44	* BM71-125-1-342YL	Yellow	22 to 16	0.046-0.110 (1.2-2.8)	0.125 (3.2)	0.047 (1.2)	1.000 (25.4)	1	1,000	M71-R4300
Fig. 44	* M71-125-1-342YL	Yellow	22 to 16	0.046-0.110 (1.2-2.8)	0.125 (3.2)	0.047 (1.2)	1.000 (25.4)	1	100	M71-R4300
Fig. 44	* BM71-187-1-342YL	Yellow	20 to 10	0.062-0.150 (1.6-3.8)	0.187 (4.7)	0.062 (1.6)	1.000 (25.4)	1	1,000	M71-R4300
Fig. 44	* M71-187-1-342YL	Yellow	20 to 10	0.062-0.150 (1.6-3.8)	0.187 (4.7)	0.062 (1.6)	1.000 (25.4)	1	100	M71-R4300
Fig. 44	* BM71-250-1-342YL	Yellow	16 to 8	0.094-0.215 (2.4-5.5)	0.250 (6.4)	0.093 (2.4)	1.000 (25.4)	1	1,000	M71-R4300
Fig. 44	* M71-250-1-342YL	Yellow	16 to 8	0.094-0.215 (2.4-5.5)	0.250 (6.4)	0.093 (2.4)	1.000 (25.4)	1	100	M71-R4300
Fig. 44	* BM71-375-1-342YL	Yellow	12 to 4	0.125-0.320 (3.2-8.1)	0.375 (9.5)	0.125 (3.1)	1.000 (25.4)	1	1,000	M71-R4300
Fig. 44	* M71-375-1-342YL	Yellow	12 to 4	0.125-0.320 (3.2-8.1)	0.375 (9.5)	0.125 (3.1)	1.000 (25.4)	1	100	M71-R4300
Fig. 44	* BM71-500-1-342YL	Yellow	8 to 1	0.187-0.450 (4.8-11.4)	0.500 (12.7)	0.187 (4.7)	1.000 (25.4)	1	1,000	M71-R4300
Fig. 44	* M71-500-1-342YL	Yellow	8 to 1	0.187-0.450 (4.8-11.4)	0.500 (12.7)	0.187 (4.7)	1.000 (25.4)	1	100	M71-R4300
Fig. 44	* M71-1000-1-342YL	Yellow	2 to 0.950 dia.	0.333-0.950 (8.5-24.1)	1.000 (25.4)	0.375 (9.5)	1.000 (25.4)	1	50	M71-R4300
1.75 inch sleeve width (dimension A):										
Fig. 44	* BM71-94-175-342	White	28 to 20	0.023-0.080 (0.6-2.0)	0.094 (2.4)	0.024 (0.6)	1.750 (44.5)	1	1,000	M71-R4300
Fig. 44	* M71-94-175-342	White	28 to 20	0.023-0.080 (0.6-2.0)	0.094 (2.4)	0.024 (0.6)	1.750 (44.5)	1	100	M71-R4300
Fig. 44	* BM71-125-175-342	White	22 to 16	0.046-0.110 (1.2-2.8)	0.125 (3.2)	0.047 (1.2)	1.750 (44.5)	1	1,000	M71-R4300
Fig. 44	* M71-125-175-342	White	22 to 16	0.046-0.110 (1.2-2.8)	0.125 (3.2)	0.047 (1.2)	1.750 (44.5)	1	100	M71-R4300
Fig. 44	* BM71-187-175-342	White	20 to 10	0.062-0.150 (1.6-3.8)	0.187 (4.7)	0.062 (1.6)	1.750 (44.5)	1	1,000	M71-R4300
Fig. 44	* M71-187-175-342	White	20 to 10	0.062-0.150 (1.6-3.8)	0.187 (4.7)	0.062 (1.6)	1.750 (44.5)	1	100	M71-R4300
Fig. 44	* BM71-250-175-342	White	16 to 8	0.094-0.215 (2.4-5.5)	0.250 (6.4)	0.093 (2.4)	1.750 (44.5)	1	1,000	M71-R4300
Fig. 44	* M71-250-175-342	White	16 to 8	0.094-0.215 (2.4-5.5)	0.250 (6.4)	0.093 (2.4)	1.750 (44.5)	1	100	M71-R4300
Fig. 44	* BM71-375-175-342	White	12 to 4	0.125-0.320 (3.2-8.1)	0.375 (9.5)	0.125 (3.1)	1.750 (44.5)	1	1,000	M71-R4300
Fig. 44	* M71-375-175-342	White	12 to 4	0.125-0.320 (3.2-8.1)	0.375 (9.5)	0.125 (3.1)	1.750 (44.5)	1	100	M71-R4300
Fig. 44	* BM71-500-175-342	White	8 to 1	0.187-0.450 (4.8-11.4)	0.500 (12.7)	0.187 (4.7)	1.750 (44.5)	1	1,000	M71-R4300
Fig. 44	* M71-500-175-342	White	8 to 1	0.187-0.450 (4.8-11.4)	0.500 (12.7)	0.187 (4.7)	1.750 (44.5)	1	100	M71-R4300
Fig. 44	* BM71-1000-175-342	White	2 to 0.950 dia.	0.333-0.950 (8.5-24.1)	1.000 (25.4)	0.375 (9.5)	1.750 (44.5)	1	500	M71-R4300
Fig. 44	* M71-1000-175-342	White	2 to 0.950 dia.	0.333-0.950 (8.5-24.1)	1.000 (25.4)	0.375 (9.5)	1.750 (44.5)	1	50	M71-R4300
Fig. 44	* BM71-94-175-342YL	Yellow	28 to 20	0.023-0.080 (0.6-2.0)	0.094 (2.4)	0.024 (0.6)	1.750 (44.5)	1	2,500	M71-R4300
Fig. 44	* M71-94-175-342YL	Yellow	28 to 20	0.023-0.080 (0.6-2.0)	0.094 (2.4)	0.024 (0.6)	1.750 (44.5)	1	100	M71-R4300
Fig. 44	* BM71-125-175-342YL	Yellow	22 to 16	0.046-0.110 (1.2-2.8)	0.125 (3.2)	0.047 (1.2)	1.750 (44.5)	1	1,000	M71-R4300
Fig. 44	* M71-125-175-342YL	Yellow	22 to 16	0.046-0.110 (1.2-2.8)	0.125 (3.2)	0.047 (1.2)	1.750 (44.5)	1	100	M71-R4300
Fig. 44	* BM71-187-175-342YL	Yellow	20 to 10	0.062-0.150 (1.6-3.8)	0.187 (4.7)	0.062 (1.6)	1.750 (44.5)	1	1,000	M71-R4300
Fig. 44	* M71-187-175-342YL	Yellow	20 to 10	0.062-0.150 (1.6-3.8)	0.187 (4.7)	0.062 (1.6)	1.750 (44.5)	1	100	M71-R4300
Fig. 44	* BM71-250-175-342YL	Yellow	16 to 8	0.094-0.215 (2.4-5.5)	0.250 (6.4)	0.093 (2.4)	1.750 (44.5)	1	1,000	M71-R4300
Fig. 44	* M71-250-175-342YL	Yellow	16 to 8	0.094-0.215 (2.4-5.5)	0.250 (6.4)	0.093 (2.4)	1.750 (44.5)	1	100	M71-R4300
Fig. 44	* BM71-375-175-342YL	Yellow	12 to 4	0.125-0.320 (3.2-8.1)	0.375 (9.5)	0.125 (3.1)	1.750 (44.5)	1	1,000	M71-R4300
Fig. 44	* M71-375-175-342YL	Yellow	12 to 4	0.125-0.320 (3.2-8.1)	0.375 (9.5)	0.125 (3.1)	1.750 (44.5)	1	100	M71-R4300
Fig. 44	* BM71-500-175-342YL	Yellow	8 to 1	0.187-0.450 (4.8-11.4)	0.500 (12.7)	0.187 (4.7)	1.750 (44.5)	1	1,000	M71-R4300
Fig. 44	* M71-500-175-342YL	Yellow	8 to 1	0.187-0.450 (4.8-11.4)	0.500 (12.7)	0.187 (4.7)	1.750 (44.5)	1	100	M71-R4300
Fig. 44	* M71-1000-175-342YL	Yellow	2 to 0.950 dia.	0.333-0.950 (8.5-24.1)	1.000 (25.4)	0.375 (9.5)	1.750 (44.5)	1	50	M71-R4300
Continuous cut-to-length sleeve width (dimension A):										
Fig. 58	* BM71C-125-342	White	22 to 16	0.046-0.110 (1.2-2.8)	0.125 (3.2)	0.047 (1.2)	50 ft. (15.2 m)	1 roll (cont.)		M71-R4300
Fig. 58	* BM71C-187-342	White	20 to 10	0.062-0.150 (1.6-3.8)	0.187 (4.7)	0.062 (1.6)	50 ft. (15.2 m)	1 roll (cont.)		M71-R4300
Fig. 58	* BM71C-250-342	White	16 to 8	0.094-0.215 (2.4-5.5)	0.250 (6.4)	0.093 (2.4)	50 ft. (15.2 m)	1 roll (cont.)		M71-R4300
Fig. 58	* BM71C-375-342	White	12 to 4	0.125-0.320 (3.2-8.1)	0.375 (9.5)	0.125 (3.1)	50 ft. (15.2 m)	1 roll (cont.)		M71-R4300
Fig. 58	* BM71C-500-342	White	8 to 1	0.187-0.450 (4.8-11.4)	0.500 (12.7)	0.187 (4.7)	50 ft. (15.2 m)	1 roll (cont.)		M71-R4300
Fig. 58	* BM71C-1000-342	White	2 to 0.950 dia.	0.333-0.950 (8.5-24.1)	1.000 (25.4)	0.375 (9.5)	50 ft. (15.2 m)	1 roll (cont.)		M71-R4300

* **WARNING:** Cancer www.P65Warnings.ca.gov

PermaSleeve® FR Fluid-Resistant Wire Markers (B-344)

3:1 heat-shrinkable wire marking sleeves fit snugly around wires for identification and protection and offer greater resistance to harsh chemicals such as fuels, lubricants and cleaning solvents.
Temp Range: -67° F to 275° F (-55° C to 135° C).

Meets specifications:

- SAE-AMS-DTL23053/6 (Class 1)
- SAE-AS-81531
- MIL-STD-202G, method 215K

Tested per:

- ASTM E 162
- ASTM E 662
- MIL-STD-202G

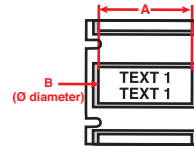

Figure 44



Figure	Catalog #	Color	Approx. Wire Gauge	Wire Diameter Range Inch (mm)	Supplied Diameter B Inch (mm)	Recovered Diameter Inch (mm)	Sleeve Width A Inch (mm)	Sleeves Per Row	Sleeves Per Roll	Rec. Ribbon
1.00 inch sleeve width (dimension A):										
Fig. 44	* BM71-094-1-344	White	28 to 20	0.023-0.080 (0.6-2.0)	0.094 (2.4)	0.023 (0.6)	1.000 (25.4)	1	2,500	M71-R6600
Fig. 44	* M71-094-1-344	White	28 to 20	0.023-0.080 (0.6-2.0)	0.094 (2.4)	0.023 (0.6)	1.000 (25.4)	1	100	M71-R6600
Fig. 44	* M71-125-1-344	White	22 to 16	0.046-0.110 (1.2-2.8)	0.125 (3.2)	0.046 (1.2)	1.000 (25.4)	1	100	M71-R6600
Fig. 44	* BM71-125-1-344	White	22 to 16	0.046-0.110 (1.2-2.8)	0.125 (3.2)	0.046 (1.2)	1.000 (25.4)	1	1,000	M71-R6600
Fig. 44	* BM71-187-1-344	White	20 to 10	0.062-0.150 (1.6-3.8)	0.187 (4.8)	0.062 (1.6)	1.000 (25.4)	1	1,000	M71-R6600
Fig. 44	* M71-187-1-344	White	20 to 10	0.062-0.150 (1.6-3.8)	0.187 (4.8)	0.062 (1.6)	1.000 (25.4)	1	100	M71-R6600
Fig. 44	* BM71-250-1-344	White	16 to 8	0.083-0.215 (2.1-5.5)	0.250 (6.4)	0.083 (2.1)	1.000 (25.4)	1	1,000	M71-R6600
Fig. 44	* M71-250-1-344	White	16 to 8	0.083-0.215 (2.1-5.5)	0.250 (6.4)	0.083 (2.1)	1.000 (25.4)	1	100	M71-R6600
Fig. 44	* BM71-375-1-344	White	12 to 4	0.125-0.320 (3.2-8.1)	0.375 (9.5)	0.125 (3.2)	1.000 (25.4)	1	1,000	M71-R6600
Fig. 44	* M71-375-1-344	White	12 to 4	0.125-0.320 (3.2-8.1)	0.375 (9.5)	0.125 (3.2)	1.000 (25.4)	1	100	M71-R6600
Fig. 44	* M71-500-1-344	White	8 to 1	0.166-0.450 (4.2-11.4)	0.500 (12.7)	0.166 (4.2)	1.000 (25.4)	1	100	M71-R6600
Fig. 44	* BM71-500-1-344	White	8 to 1	0.166-0.450 (4.2-11.4)	0.500 (12.7)	0.166 (4.2)	1.000 (25.4)	1	1,000	M71-R6600
Fig. 44	* M71-750-1-344	White	8 to 1	0.250-0.700 (6.4-17.8)	0.750 (19.1)	0.250 (6.4)	1.000 (25.4)	1	100	M71-R6600
Fig. 44	* BM71-094-1-344YL	Yellow	28 to 20	0.023-0.080 (0.6-2.0)	0.094 (2.4)	0.023 (0.6)	1.000 (25.4)	1	2,500	M71-R6600
Fig. 44	* M71-094-1-344YL	Yellow	28 to 20	0.023-0.080 (0.6-2.0)	0.094 (2.4)	0.023 (0.6)	1.000 (25.4)	1	100	M71-R6600
Fig. 44	* M71-125-1-344YL	Yellow	22 to 16	0.046-0.110 (1.2-2.8)	0.125 (3.2)	0.046 (1.2)	1.000 (25.4)	1	100	M71-R6600
Fig. 44	* BM71-125-1-344YL	Yellow	22 to 16	0.046-0.110 (1.2-2.8)	0.125 (3.2)	0.046 (1.2)	1.000 (25.4)	1	1,000	M71-R6600
Fig. 44	* M71-187-1-344YL	Yellow	20 to 10	0.062-0.150 (1.6-3.8)	0.187 (4.8)	0.062 (1.6)	1.000 (25.4)	1	100	M71-R6600
Fig. 44	* BM71-187-1-344YL	Yellow	20 to 10	0.062-0.150 (1.6-3.8)	0.187 (4.8)	0.062 (1.6)	1.000 (25.4)	1	1,000	M71-R6600
Fig. 44	* M71-250-1-344YL	Yellow	16 to 8	0.083-0.215 (2.1-5.5)	0.250 (6.4)	0.083 (2.1)	1.000 (25.4)	1	100	M71-R6600
Fig. 44	* BM71-250-1-344YL	Yellow	16 to 8	0.083-0.215 (2.1-5.5)	0.250 (6.4)	0.083 (2.1)	1.000 (25.4)	1	1,000	M71-R6600
Fig. 44	* M71-375-1-344YL	Yellow	12 to 4	0.125-0.320 (3.2-8.1)	0.375 (9.5)	0.125 (3.2)	1.000 (25.4)	1	100	M71-R6600
Fig. 44	* BM71-375-1-344YL	Yellow	12 to 4	0.125-0.320 (3.2-8.1)	0.375 (9.5)	0.125 (3.2)	1.000 (25.4)	1	1,000	M71-R6600
Fig. 44	* M71-500-1-344YL	Yellow	8 to 1	0.166-0.450 (4.2-11.4)	0.500 (12.7)	0.166 (4.2)	1.000 (25.4)	1	100	M71-R6600
Fig. 44	* BM71-500-1-344YL	Yellow	8 to 1	0.166-0.450 (4.2-11.4)	0.500 (12.7)	0.166 (4.2)	1.000 (25.4)	1	1,000	M71-R6600
Fig. 44	* M71-750-1-344YL	Yellow	8 to 1	0.250-0.700 (6.4-17.8)	0.750 (19.1)	0.250 (6.4)	1.000 (25.4)	1	100	M71-R6600
1.75 inch sleeve width (dimension A):										
Fig. 44	* M71-094-175-344	White	28 to 20	0.023-0.080 (0.6-2.0)	0.094 (2.4)	0.023 (0.6)	1.750 (44.5)	1	100	M71-R6600
Fig. 44	* BM71-94-175-344	White	28 to 20	0.023-0.080 (0.6-2.0)	0.094 (2.4)	0.023 (0.6)	1.750 (44.5)	1	2,500	M71-R6600
Fig. 44	* M71-125-175-344	White	22 to 16	0.046-0.110 (1.2-2.8)	0.125 (3.2)	0.046 (1.2)	1.750 (44.5)	1	100	M71-R6600
Fig. 44	* BM71-125-175-344	White	22 to 16	0.046-0.110 (1.2-2.8)	0.125 (3.2)	0.046 (1.2)	1.750 (44.5)	1	1,000	M71-R6600
Fig. 44	* M71-187-175-344	White	20 to 10	0.062-0.150 (1.6-3.8)	0.187 (4.8)	0.062 (1.6)	1.750 (44.5)	1	100	M71-R6600
Fig. 44	* BM71-187-175-344	White	20 to 10	0.062-0.150 (1.6-3.8)	0.187 (4.8)	0.062 (1.6)	1.750 (44.5)	1	1,000	M71-R6600
Fig. 44	* M71-250-175-344	White	16 to 8	0.083-0.215 (2.1-5.5)	0.250 (6.4)	0.083 (2.1)	1.750 (44.5)	1	100	M71-R6600
Fig. 44	* BM71-250-175-344	White	16 to 8	0.083-0.215 (2.1-5.5)	0.250 (6.4)	0.083 (2.1)	1.750 (44.5)	1	1,000	M71-R6600
Fig. 44	* M71-375-175-344	White	12 to 4	0.125-0.320 (3.2-8.1)	0.375 (9.5)	0.125 (3.2)	1.750 (44.5)	1	100	M71-R6600
Fig. 44	* BM71-375-175-344	White	12 to 4	0.125-0.320 (3.2-8.1)	0.375 (9.5)	0.125 (3.2)	1.750 (44.5)	1	1,000	M71-R6600
Fig. 44	* M71-500-175-344	White	8 to 1	0.166-0.450 (4.2-11.4)	0.500 (12.7)	0.166 (4.2)	1.750 (44.5)	1	100	M71-R6600
Fig. 44	* BM71-500-175-344	White	8 to 1	0.166-0.450 (4.2-11.4)	0.500 (12.7)	0.166 (4.2)	1.750 (44.5)	1	1,000	M71-R6600
Fig. 44	* M71-750-175-344	White	8 to 1	0.250-0.700 (6.4-17.8)	0.750 (19.1)	0.250 (6.4)	1.750 (44.5)	1	100	M71-R6600
Fig. 44	* M71-094-175-344YL	Yellow	28 to 20	0.023-0.080 (0.6-2.0)	0.094 (2.4)	0.023 (0.6)	1.750 (44.5)	1	100	M71-R6600
Fig. 44	* BM71-94-175-344YL	Yellow	28 to 20	0.023-0.080 (0.6-2.0)	0.094 (2.4)	0.023 (0.6)	1.750 (44.5)	1	2,500	M71-R6600
Fig. 44	* M71-125-175-344YL	Yellow	22 to 16	0.046-0.110 (1.2-2.8)	0.125 (3.2)	0.046 (1.2)	1.750 (44.5)	1	100	M71-R6600
Fig. 44	* BM71-125-175-344YL	Yellow	22 to 16	0.046-0.110 (1.2-2.8)	0.125 (3.2)	0.046 (1.2)	1.750 (44.5)	1	1,000	M71-R6600
Fig. 44	* M71-187-175-344YL	Yellow	20 to 10	0.062-0.150 (1.6-3.8)	0.187 (4.8)	0.062 (1.6)	1.750 (44.5)	1	100	M71-R6600
Fig. 44	* BM71-187-175-344YL	Yellow	20 to 10	0.062-0.150 (1.6-3.8)	0.187 (4.8)	0.062 (1.6)	1.750 (44.5)	1	1,000	M71-R6600
Fig. 44	* M71-250-175-344YL	Yellow	16 to 8	0.083-0.215 (2.1-5.5)	0.250 (6.4)	0.083 (2.1)	1.750 (44.5)	1	100	M71-R6600
Fig. 44	* BM71-250-175-344YL	Yellow	16 to 8	0.083-0.215 (2.1-5.5)	0.250 (6.4)	0.083 (2.1)	1.750 (44.5)	1	1,000	M71-R6600
Fig. 44	* M71-375-175-344YL	Yellow	12 to 4	0.125-0.320 (3.2-8.1)	0.375 (9.5)	0.125 (3.2)	1.750 (44.5)	1	100	M71-R6600
Fig. 44	* BM71-375-175-344YL	Yellow	12 to 4	0.125-0.320 (3.2-8.1)	0.375 (9.5)	0.125 (3.2)	1.750 (44.5)	1	1,000	M71-R6600
Fig. 44	* M71-500-175-344YL	Yellow	8 to 1	0.166-0.450 (4.2-11.4)	0.500 (12.7)	0.166 (4.2)	1.750 (44.5)	1	100	M71-R6600
Fig. 44	* BM71-500-175-344YL	Yellow	8 to 1	0.166-0.450 (4.2-11.4)	0.500 (12.7)	0.166 (4.2)	1.750 (44.5)	1	1,000	M71-R6600
Fig. 44	* M71-750-175-344YL	Yellow	8 to 1	0.250-0.700 (6.4-17.8)	0.750 (19.1)	0.250 (6.4)	1.750 (44.5)	1	100	M71-R6600

* **WARNING:** Cancer www.P65Warnings.ca.gov

PermaSleeve® LSZH Low-Smoke Zero-Halogen Polyolefin Wire Markers (B-7641)

2:1 heat-shrinkable, low halogen wire marking sleeves offer outstanding fire safety properties and minimal smoke emission. These low-smoke zero-halogen materials have an operating temperature of -22° F to 221° F (-30° C to 105° C).

Meets specifications:

- SAE-AS-81531
- EN45545-2
- RoHS compliant

Tested per:

- ASTM E162
- ASTM E662
- MIL-STD-202

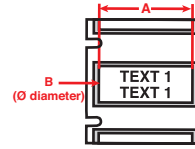

Figure 44



Figure	Catalog #	Color	Approx. Wire Gauge	Wire Diameter Range Inch (mm)	Supplied Diameter B Inch (mm)	Recovered Diameter Inch (mm)	Sleeve Width A Inch (mm)	Sleeves Per Row	Sleeves Per Roll	Rec. Ribbon
1.00 inch sleeve width (dimension A):										
Fig. 44	M71-94-1-7641	White	28 to 20	0.047-0.080 (1.2-2.0)	0.094 (2.4)	0.047 (1.2)	1.000 (25.4)	1	100	M71-R6600
Fig. 44	BM71-94-1-7641	White	28 to 20	0.047-0.080 (1.2-2.0)	0.094 (2.4)	0.047 (1.2)	1.000 (25.4)	1	2,500	M71-R6600
Fig. 44	M71-125-1-7641	White	22 to 16	0.062-0.150 (1.6-3.8)	0.125 (3.2)	0.062 (1.6)	1.000 (25.4)	1	100	M71-R6600
Fig. 44	BM71-125-1-7641	White	22 to 16	0.062-0.150 (1.6-3.8)	0.125 (3.2)	0.062 (1.6)	1.000 (25.4)	1	1,000	M71-R6600
Fig. 44	BM71-187-1-7641	White	20 to 10	0.062-0.150 (1.6-3.8)	0.187 (4.8)	0.062 (1.6)	1.000 (25.4)	1	1,000	M71-R6600
Fig. 44	M71-187-1-7641	White	20 to 10	0.062-0.150 (1.6-3.8)	0.187 (4.8)	0.062 (1.6)	1.000 (25.4)	1	100	M71-R6600
Fig. 44	M71-250-1-7641	White	16 to 8	0.125-0.215 (3.2-5.5)	0.250 (6.4)	0.125 (3.2)	1.000 (25.4)	1	100	M71-R6600
Fig. 44	BM71-250-1-7641	White	16 to 8	0.125-0.215 (3.2-5.5)	0.250 (6.4)	0.125 (3.2)	1.000 (25.4)	1	1,000	M71-R6600
Fig. 44	M71-375-1-7641	White	12 to 4	0.188-0.320 (4.8-8.1)	0.375 (9.5)	0.188 (4.8)	1.000 (25.4)	1	100	M71-R6600
Fig. 44	BM71-375-1-7641	White	12 to 4	0.188-0.320 (4.8-8.1)	0.375 (9.5)	0.188 (4.8)	1.000 (25.4)	1	1,000	M71-R6600
Fig. 44	M71-500-1-7641	White	8 to 1	0.250-0.450 (6.4-11.4)	0.500 (12.7)	0.250 (6.4)	1.000 (25.4)	1	100	M71-R6600
Fig. 44	BM71-500-1-7641	White	8 to 1	0.250-0.450 (6.4-11.4)	0.500 (12.7)	0.250 (6.4)	1.000 (25.4)	1	600	M71-R6600
Fig. 44	M71-750-1-7641	White	8 to 1	0.375-0.700 (9.5-17.8)	0.750 (19.1)	0.375 (9.5)	1.000 (25.4)	1	75	M71-R6600
Fig. 44	BM71-750-1-7641	White	8 to 1	0.375-0.700 (9.5-17.8)	0.750 (19.1)	0.375 (9.5)	1.000 (25.4)	1	600	M71-R6600
Fig. 44	M71-94-1-7641Y	Yellow	28 to 20	0.047-0.080 (1.2-2.0)	0.094 (2.4)	0.047 (1.2)	1.000 (25.4)	1	100	M71-R6600
Fig. 44	BM71-94-1-7641Y	Yellow	28 to 20	0.047-0.080 (1.2-2.0)	0.094 (2.4)	0.047 (1.2)	1.000 (25.4)	1	2,500	M71-R6600
Fig. 44	M71-125-1-7641Y	Yellow	22 to 16	0.062-0.150 (1.6-3.8)	0.125 (3.2)	0.062 (1.6)	1.000 (25.4)	1	100	M71-R6600
Fig. 44	BM71-125-1-7641Y	Yellow	22 to 16	0.062-0.150 (1.6-3.8)	0.125 (3.2)	0.062 (1.6)	1.000 (25.4)	1	1,000	M71-R6600
Fig. 44	BM71-187-1-7641Y	Yellow	20 to 10	0.062-0.150 (1.6-3.8)	0.187 (4.8)	0.062 (1.6)	1.000 (25.4)	1	1,000	M71-R6600
Fig. 44	M71-187-1-7641Y	Yellow	20 to 10	0.062-0.150 (1.6-3.8)	0.187 (4.8)	0.062 (1.6)	1.000 (25.4)	1	100	M71-R6600
Fig. 44	M71-250-1-7641Y	Yellow	16 to 8	0.125-0.215 (3.2-5.5)	0.250 (6.4)	0.125 (3.2)	1.000 (25.4)	1	100	M71-R6600
Fig. 44	BM71-250-1-7641Y	Yellow	16 to 8	0.125-0.215 (3.2-5.5)	0.250 (6.4)	0.125 (3.2)	1.000 (25.4)	1	1,000	M71-R6600
Fig. 44	M71-375-1-7641Y	Yellow	12 to 4	0.188-0.320 (4.8-8.1)	0.375 (9.5)	0.188 (4.8)	1.000 (25.4)	1	100	M71-R6600
Fig. 44	BM71-375-1-7641Y	Yellow	12 to 4	0.188-0.320 (4.8-8.1)	0.375 (9.5)	0.188 (4.8)	1.000 (25.4)	1	1,000	M71-R6600
Fig. 44	M71-500-1-7641Y	Yellow	8 to 1	0.250-0.450 (6.4-11.4)	0.500 (12.7)	0.250 (6.4)	1.000 (25.4)	1	100	M71-R6600
Fig. 44	BM71-500-1-7641Y	Yellow	8 to 1	0.250-0.450 (6.4-11.4)	0.500 (12.7)	0.250 (6.4)	1.000 (25.4)	1	600	M71-R6600
Fig. 44	M71-750-1-7641Y	Yellow	8 to 1	0.375-0.700 (9.5-17.8)	0.750 (19.1)	0.375 (9.5)	1.000 (25.4)	1	75	M71-R6600
Fig. 44	BM71-750-1-7641Y	Yellow	8 to 1	0.375-0.700 (9.5-17.8)	0.750 (19.1)	0.375 (9.5)	1.000 (25.4)	1	600	M71-R6600
1.75 inch sleeve width (dimension A):										
Fig. 44	M71-94-175-7641	White	28 to 20	0.047-0.080 (1.2-2.0)	0.094 (2.4)	0.047 (1.2)	1.750 (44.5)	1	100	M71-R6600
Fig. 44	BM71-94-175-7641	White	28 to 20	0.047-0.080 (1.2-2.0)	0.094 (2.4)	0.047 (1.2)	1.750 (44.5)	1	2,500	M71-R6600
Fig. 44	M71-125-175-7641	White	22 to 16	0.062-0.150 (1.6-3.8)	0.125 (3.2)	0.062 (1.6)	1.750 (44.5)	1	100	M71-R6600
Fig. 44	BM71-125-175-7641	White	22 to 16	0.062-0.150 (1.6-3.8)	0.125 (3.2)	0.062 (1.6)	1.750 (44.5)	1	1,000	M71-R6600
Fig. 44	M71-187-175-7641	White	20 to 10	0.062-0.150 (1.6-3.8)	0.187 (4.8)	0.062 (1.6)	1.750 (44.5)	1	100	M71-R6600
Fig. 44	BM71-187-175-7641	White	20 to 10	0.062-0.150 (1.6-3.8)	0.187 (4.8)	0.062 (1.6)	1.750 (44.5)	1	1,000	M71-R6600
Fig. 44	M71-250-175-7641	White	16 to 8	0.125-0.215 (3.2-5.5)	0.250 (6.4)	0.125 (3.2)	1.750 (44.5)	1	100	M71-R6600
Fig. 44	BM71-250-175-7641	White	16 to 8	0.125-0.215 (3.2-5.5)	0.250 (6.4)	0.125 (3.2)	1.750 (44.5)	1	1,000	M71-R6600
Fig. 44	M71-375-175-7641	White	12 to 4	0.188-0.320 (4.8-8.1)	0.375 (9.5)	0.188 (4.8)	1.750 (44.5)	1	100	M71-R6600
Fig. 44	BM71-375-175-7641	White	12 to 4	0.188-0.320 (4.8-8.1)	0.375 (9.5)	0.188 (4.8)	1.750 (44.5)	1	1,000	M71-R6600
Fig. 44	M71-500-175-7641	White	8 to 1	0.250-0.450 (6.4-11.4)	0.500 (12.7)	0.250 (6.4)	1.750 (44.5)	1	100	M71-R6600
Fig. 44	BM71-500-175-7641	White	8 to 1	0.250-0.450 (6.4-11.4)	0.500 (12.7)	0.250 (6.4)	1.750 (44.5)	1	600	M71-R6600
Fig. 44	M71-750-175-7641	White	8 to 1	0.375-0.700 (9.5-17.8)	0.750 (19.1)	0.375 (9.5)	1.750 (44.5)	1	75	M71-R6600
Fig. 44	BM71-750-175-7641	White	8 to 1	0.375-0.700 (9.5-17.8)	0.750 (19.1)	0.375 (9.5)	1.750 (44.5)	1	600	M71-R6600
Fig. 44	M71-94-175-7641Y	Yellow	28 to 20	0.047-0.080 (1.2-2.0)	0.094 (2.4)	0.047 (1.2)	1.750 (44.5)	1	100	M71-R6600
Fig. 44	BM71-94-175-7641Y	Yellow	28 to 20	0.047-0.080 (1.2-2.0)	0.094 (2.4)	0.047 (1.2)	1.750 (44.5)	1	2,500	M71-R6600
Fig. 44	M71-125-175-7641Y	Yellow	22 to 16	0.062-0.150 (1.6-3.8)	0.125 (3.2)	0.062 (1.6)	1.750 (44.5)	1	100	M71-R6600
Fig. 44	BM71-125-175-7641Y	Yellow	22 to 16	0.062-0.150 (1.6-3.8)	0.125 (3.2)	0.062 (1.6)	1.750 (44.5)	1	1,000	M71-R6600
Fig. 44	M71-187-175-7641Y	Yellow	20 to 10	0.062-0.150 (1.6-3.8)	0.187 (4.8)	0.062 (1.6)	1.750 (44.5)	1	100	M71-R6600
Fig. 44	BM71-187-175-7641Y	Yellow	20 to 10	0.062-0.150 (1.6-3.8)	0.187 (4.8)	0.062 (1.6)	1.750 (44.5)	1	1,000	M71-R6600
Fig. 44	M71-250-175-7641Y	Yellow	16 to 8	0.125-0.215 (3.2-5.5)	0.250 (6.4)	0.125 (3.2)	1.750 (44.5)	1	100	M71-R6600
Fig. 44	BM71-250-175-7641Y	Yellow	16 to 8	0.125-0.215 (3.2-5.5)	0.250 (6.4)	0.125 (3.2)	1.750 (44.5)	1	1,000	M71-R6600
Fig. 44	M71-375-175-7641Y	Yellow	12 to 4	0.188-0.320 (4.8-8.1)	0.375 (9.5)	0.188 (4.8)	1.750 (44.5)	1	100	M71-R6600
Fig. 44	BM71-375-175-7641Y	Yellow	12 to 4	0.188-0.320 (4.8-8.1)	0.375 (9.5)	0.188 (4.8)	1.750 (44.5)	1	1,000	M71-R6600
Fig. 44	M71-500-175-7641Y	Yellow	8 to 1	0.250-0.450 (6.4-11.4)	0.500 (12.7)	0.250 (6.4)	1.750 (44.5)	1	100	M71-R6600
Fig. 44	BM71-500-175-7641Y	Yellow	8 to 1	0.250-0.450 (6.4-11.4)	0.500 (12.7)	0.250 (6.4)	1.750 (44.5)	1	600	M71-R6600
Fig. 44	M71-750-175-7641Y	Yellow	8 to 1	0.375-0.700 (9.5-17.8)	0.750 (19.1)	0.375 (9.5)	1.750 (44.5)	1	75	M71-R6600
Fig. 44	BM71-750-175-7641Y	Yellow	8 to 1	0.375-0.700 (9.5-17.8)	0.750 (19.1)	0.375 (9.5)	1.750 (44.5)	1	600	M71-R6600

Component ID Labels (B-423 and B-428)

Various materials for relays, solenoids, PCBs, electronic components and more.

- **B-423 Polyester Material:** White glossy polyester
- **B-428 Polyester Material:** Metallized matte polyester

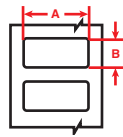

Figure 2



Figure 33

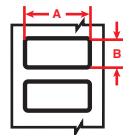

Figure 46
w/ black border



Figure	Catalog #	B#	Material	Color	Label Width A Inch (mm)	Label Height B Inch (mm)	Labels Per Roll	Rec. Ribbon
B-423 Permanent Polyester Material								
Fig. 2	M71-1-423	B-423	Polyester	White	0.250 (6.35)	0.250 (6.4)	750	M71-R6000
Fig. 2	M71-3-423	B-423	Polyester	White	0.375 (9.53)	0.375 (9.5)	500	M71-R6000
Fig. 2	M71-4-423	B-423	Polyester	White	0.400 (10.2)	0.400 (10.2)	500	M71-R6000
Fig. 33	M71C-500-423	B-423	Polyester	White	0.500 (12.7)	50 ft. (15.24 m)	1 roll (cont.)	M71-R6000
Fig. 2	M71-5-423	B-423	Polyester	White	0.500 (12.7)	0.200 (5.1)	750	M71-R6000
Fig. 2	M71-6-423	B-423	Polyester	White	0.500 (12.7)	0.280 (7.0)	750	M71-R6000
Fig. 2	BM71-7-423	B-423	Polyester	White	0.500 (12.7)	0.500 (12.7)	5,000	M71-R6000
Fig. 2	M71-7-423	B-423	Polyester	White	0.500 (12.7)	0.500 (12.7)	500	M71-R6000
Fig. 2	M71-9-423	B-423	Polyester	White	0.650 (16.5)	0.200 (5.1)	750	M71-R6000
Fig. 2	M71-10-423	B-423	Polyester	White	0.750 (19.0)	0.250 (6.4)	750	M71-R6000
Fig. 2	M71-13-423	B-423	Polyester	White	0.900 (22.8)	0.250 (6.4)	750	M71-R6000
Fig. 2	M71-14-423	B-423	Polyester	White	1.000 (25.4)	0.187 (4.8)	750	M71-R6000
Fig. 2	M71-15-423	B-423	Polyester	White	1.000 (25.4)	0.275 (7.0)	750	M71-R6000
Fig. 2	BM71-16-423	B-423	Polyester	White	1.000 (25.4)	0.375 (9.53)	5000	M71-R6000
Fig. 2	M71-16-423	B-423	Polyester	White	1.000 (25.4)	0.375 (9.53)	500	M71-R6000
Fig. 2	BM71-17-423	B-423	Polyester	White	1.000 (25.4)	0.500 (12.7)	5,000	M71-R6000
Fig. 2	M71-17-423	B-423	Polyester	White	1.000 (25.4)	0.500 (12.7)	500	M71-R6000
Fig. 2	BM71-19-423	B-423	Polyester	White	1.000 (25.4)	1.000 (25.4)	2,500	M71-R6000
Fig. 2	M71-19-423	B-423	Polyester	White	1.000 (25.4)	1.000 (25.4)	250	M71-R6000
Fig. 46	M71-24-423-BK	B-423	Polyester	Black Border	1.130 (28.7)	0.500 (12.7)	500	M71-R6000
Fig. 2	M71-25-423	B-423	Polyester	White	1.250 (31.8)	0.250 (6.4)	750	M71-R6000
Fig. 2	M71-27-423	B-423	Polyester	White	1.500 (38.1)	0.125 (3.2)	750	M71-R6000
Fig. 2	M71-28-423	B-423	Polyester	White	1.500 (38.1)	0.250 (6.4)	750	M71-R6000
Fig. 2	BM71-29-423	B-423	Polyester	White	1.500 (38.1)	0.500 (12.7)	5,000	M71-R6000
Fig. 2	M71-29-423	B-423	Polyester	White	1.500 (38.1)	0.500 (12.7)	500	M71-R6000
Fig. 2	M71-31-423	B-423	Polyester	White	1.500 (38.1)	1.000 (25.4)	250	M71-R6000
Fig. 2	M71-32-423	B-423	Polyester	White	1.500 (38.1)	1.500 (38.1)	250	M71-R6000
Fig. 2	M71-2-423	B-423	Polyester	White	2.000 (50.8)	0.250 (6.4)	100	M71-R6000
Fig. 2	BM71-20-423	B-423	Polyester	White	2.000 (50.8)	1.000 (25.4)	1,000	M71-R6000
Fig. 2	M71-20-423	B-423	Polyester	White	2.000 (50.8)	1.000 (25.4)	100	M71-R6000
Fig. 2	M71-26-423	B-423	Polyester	White	2.750 (69.9)	1.250 (31.8)	100	M71-R6000
Fig. 2	M71-22-423	B-423	Polyester	White	3.000 (76.2)	1.000 (25.4)	100	M71-R6000
Fig. 2	M71-37-423	B-423	Polyester	White	3.000 (76.2)	1.900 (48.3)	100	M71-R6000
Fig. 2	M71-23-423	B-423	Polyester	White	4.000 (101.6)	1.000 (25.4)	100	M71-R6000
Fig. 2	M71-38-423	B-423	Polyester	White	4.000 (101.6)	1.900 (48.3)	100	M71-R6000
B-428 Metallized Polyester Material								
Fig. 2	M71-15-428	B-428	Polyester	Lt Gray	1.000 (25.4)	0.275 (7.0)	750	M71-R4300
Fig. 2	BM71-17-428	B-428	Polyester	Lt Gray	1.000 (25.4)	0.500 (12.7)	5,000	M71-R4300
Fig. 2	M71-17-428	B-428	Polyester	Lt Gray	1.000 (25.4)	0.500 (12.7)	500	M71-R4300
Fig. 2	M71-29-428	B-428	Polyester	Lt Gray	1.500 (38.1)	0.500 (12.7)	500	M71-R4300
Fig. 2	BM71-20-428	B-428	Polyester	Lt Gray	2.000 (50.8)	1.000 (25.4)	1,000	M71-R4300
Fig. 2	M71-20-428	B-428	Polyester	Lt Gray	2.000 (50.8)	1.000 (25.4)	100	M71-R4300
Fig. 2	M71-26-428	B-428	Polyester	Lt Gray	2.750 (69.9)	1.250 (31.8)	100	M71-R4300
Fig. 2	M71-22-428	B-428	Polyester	Lt Gray	3.000 (76.2)	1.000 (25.4)	100	M71-R4300
Fig. 2	M71-38-428	B-428	Polyester	Lt Gray	4.000 (101.6)	1.900 (48.3)	100	M71-R4300

Polyimide Circuit Board Labels (B-724 and B-727)

Various materials for PCBs, electronic components and more.

- **B-724 Polyimide Material:** Amber matte polyimide with permanent adhesive; can survive on the top or bottom side of PCBs through the solder process
- **B-727 Polyimide Material:** White glossy polyimide with permanent adhesive; can survive through the solder process

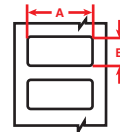

Figure 2



Figure	Catalog #	B#	Material	Color	Label Width A Inch (mm)	Label Height B Inch (mm)	Labels Per Roll	Rec. Ribbon
B-724 Matte Polyimide Material								
Fig. 2	M71-9-724	B-724	Polyimide	Amber	0.650 (16.5)	0.200 (5.1)	750	M71-R4300
Fig. 2	M71-13-724	B-724	Polyimide	Amber	0.900 (22.9)	0.250 (6.4)	750	M71-R4300
Fig. 2	M71-16-724	B-724	Polyimide	Amber	1.000 (25.4)	0.375 (9.5)	500	M71-R4300
Fig. 2	M71-17-724	B-724	Polyimide	Amber	1.000 (25.4)	0.500 (12.7)	500	M71-R4300
Fig. 2	M71-28-724	B-724	Polyimide	Amber	1.500 (38.1)	0.250 (6.4)	750	M71-R4300
B-727 Glossy Polyimide Material								
Fig. 2	M71-10-727	B-727	Polyimide	White	0.750 (19.1)	0.250 (6.4)	750	M71-R6000
Fig. 2	M71-16-727	B-727	Polyimide	White	1.000 (25.4)	0.375 (9.5)	500	M71-R6000

Electrostatic Dissipative Labels (B-473, B-717 and B-718)

Low-profile polyimide and polyester materials that have static dissipative properties. Primarily used for circuit board and electronic component labeling.

- **B-473 Electrostatic Dissipative Polyester Material:** White glossy polyester with a permanent static dissipative adhesive and liner
- **B-717 Electrostatic Dissipative Polyimide Material:** High-temperature white glossy polyimide material (2 mil) with a permanent static dissipative adhesive and liner for PCB identification
- **B-718 Electrostatic Dissipative Polyimide Material:** High-temperature low-profile white glossy polyimide material (1 mil) with a permanent static dissipative adhesive and liner for PCB identification

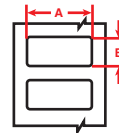

Figure 2



Figure	Catalog #	B#	Material	Color	Label Width A Inch (mm)	Label Height B Inch (mm)	Labels Per Roll	Rec. Ribbon
B-473 Glossy White Polyester								
Fig. 2	* M71-6-473	B-473	Polyester	White	0.500 (12.7)	0.275 (7.0)	750	M71-R6000
Fig. 2	* M71-9-473	B-473	Polyester	White	0.650 (16.5)	0.200 (5.1)	750	M71-R6000
Fig. 2	* M71-10-473	B-473	Polyester	White	0.750 (19.1)	0.250 (6.4)	750	M71-R6000
Fig. 2	* M71-16-473	B-473	Polyester	White	1.000 (25.4)	0.375 (9.5)	500	M71-R6000
Fig. 2	* M71-17-473	B-473	Polyester	White	1.000 (25.4)	0.500 (12.7)	500	M71-R6000
Fig. 2	* M71-28-473	B-473	Polyester	White	1.500 (38.1)	0.250 (6.4)	750	M71-R6000
B-717 Glossy White Static Dissipative Polyimide								
Fig. 2	* M71-14-717	B-717	Polyimide	White	1.000 (25.4)	0.187 (4.8)	750	M71-R6000
Fig. 2	* M71-2-717	B-717	Polyimide	White	2.000 (50.8)	0.250 (6.4)	100	M71-R6000
B-718 Glossy White Low Profile Static Dissipative Polyimide								
Fig. 2	* M71-4-718	B-718	Polyimide	White	0.400 (10.2)	0.400 (10.2)	500	M71-R6000
Fig. 2	* M71-9-718	B-718	Polyimide	White	0.650 (16.5)	0.200 (5.1)	750	M71-R6000
Fig. 2	* M71-25-718	B-718	Polyimide	White	1.250 (31.8)	0.250 (6.4)	750	M71-R6000

* **WARNING:** Cancer www.P65Warnings.ca.gov

Technical Data Sheets

Technical Data Sheets for all Brady materials are available online at

BradyID.com/TechData

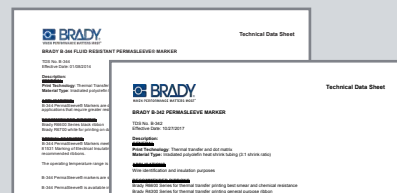

Tamper-Indicating Labels (B-351, B-362 and B-530)

Labels fracture to show signs of product tampering and prevent one-piece label removal. Use caution when removing from liner as material is fragile.

- **B-351 Destructible Vinyl Material:** Matte white material with permanent adhesive
- **B-362 Destructible Vinyl Material:** Metallized vinyl material with permanent adhesive has great fuel and oil resistance
- **B-530 Tamper-Resistant Vinyl Material:** White material with permanent adhesive

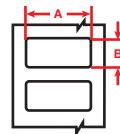

Figure 2



Figure 3



Figure	Catalog #	B#	Material	Color	Label Width A Inch (mm)	Label Height B Inch (mm)	Labels Per Roll	Rec. Ribbon
B-351 Destructible Vinyl Labels								
Fig. 2	M71-17-351	B-351	Vinyl	White	1.000 (25.4)	0.500 (12.7)	500	M71-R6200
Fig. 2	M71-31-351	B-351	Vinyl	White	1.500 (38.1)	1.000 (25.4)	250	M71-R6200
Fig. 2	M71-20-351	B-351	Vinyl	White	2.000 (50.8)	1.000 (25.4)	100	M71-R6200
Fig. 2	M71-37-351	B-351	Vinyl	White	3.000 (76.2)	1.900 (48.3)	100	M71-R6200
B-362 Destructible Vinyl Labels								
Fig. 2	* M71-17-362	B-362	Vinyl	Silver	1.000 (25.4)	0.500 (12.7)	500	M71-R6000
Fig. 2	* M71-31-362	B-362	Vinyl	Silver	1.500 (38.1)	1.000 (25.4)	250	M71-R6000
Fig. 2	* M71-20-362	B-362	Vinyl	Silver	2.000 (50.8)	1.000 (25.4)	100	M71-R6000
Fig. 2	* M71-37-362	B-362	Vinyl	Silver	3.000 (76.2)	1.900 (48.3)	100	M71-R6000
B-530 Tamper-Resistant Vinyl Film								
Fig. 33	M71C-500-530	B-530	Vinyl	White	0.500 (12.7)	50 ft. (15.2 m)	1 roll (cont.)	M71-R6000
Fig. 33	M71C-1000-530	B-530	Vinyl	White	1.000 (25.4)	50 ft. (15.2 m)	1 roll (cont.)	M71-R6000
Fig. 33	M71C-2000-530	B-530	Vinyl	White	2.000 (50.8)	50 ft. (15.2 m)	1 roll (cont.)	M71-R6000

* ⚠️ **WARNING:** Cancer www.P65Warnings.ca.gov



BMP71 Print Ribbon

Self-contained ribbon cartridges snap right into the BMP71 printer with ease and do not unravel or roll away when outside the printer.

Using the correct material and ribbon pair is critical in creating durable, long-lasting and smear-proof print. Use the ribbon compatibility guide on the next page to help determine which ribbon is best suited for your label material.

Catalog #	Color	Ribbon Size
M71-R4300	Black	2.0 in. x 150 ft. (50.8mm x 45.7 m)
M71-R6000	Black	2.0 in. x 150 ft. (50.8mm x 45.7 m)
M71-R6200	Black	2.0 in. x 150 ft. (50.8mm x 45.7 m)
M71-R6400	Black	2.0 in. x 150 ft. (50.8mm x 45.7 m)
M71-R6600	Black	2.0 in. x 150 ft. (50.8mm x 45.7 m)
M71-R4400-WT	White	2.0 in. x 150 ft. (50.8mm x 45.7 m)
M71-R6800-WT	White	2.0 in. x 120 ft. (50.8mm x 36.6 m)
M71-R6900-RD	Red	2.0 in. x 150 ft. (50.8mm x 45.7 m)
M71-R6900-GN	Green	2.0 in. x 150 ft. (50.8mm x 45.7 m)
M71-R6900-BL	Blue	2.0 in. x 150 ft. (50.8mm x 45.7 m)
M71-R6900-MA	Magenta	2.0 in. x 150 ft. (50.8mm x 45.7 m)
M71-R6900-YL	Yellow	2.0 in. x 150 ft. (50.8mm x 45.7 m)

How many labels can be printed per ribbon?

Have you ever wondered approximately how many labels you can print from one ribbon? Try this formula:

Note: Our standard BMP71 ribbons are 1,800 in. (150 ft.) long.

Step 1: label height + 0.10 = X

Step 2: 1,800 inches ÷ X = total labels per ribbon

Example: M71-31-362 is a 1.0 inch tall label
 1.0 inch label height + 0.10 = 1.10
 1,800 inches ÷ 1.10 = 1,636 labels per ribbon

Material and Ribbon Compatibility

B-# Material		M71-R4300 (Black)	M71-R6000 (Black)	M71-R6200 (Black)	M71-R6400 (Black)	M71-R6600 (Black)	M71-R4400-WT (White)	M71-R6800-WT (White)	M71-R6900 (Colors)
B-109	Polyethylene tags	●		▲					
B-145	Polyethylene tags		●	▲			▲		
B-145FR	Polyethylene tags		●	▲			▲		▲
B-321*	Polyolefin			●					
B-342	Polyolefin	●				▲			
B-344	Fluid-resistant polyolefin		▲			●			
B-345*	High-temp polyolefin		▲			●		▲	
B-351	Destructible vinyl		▲	●					▲
B-362	Destructible vinyl		●						▲
B-353*	Paper	●							
B-390*	Durasleeve polypropylene		●						▲
B-403	Dissolvable paper	●							
B-412	Polypropylene tags	▲		●					
B-422	Polyester		● UL						▲
B-423	Polyester		● UL	▲					▲
B-424	Paper	●							▲
B-425	Polypropylene	●		▲					
B-427	Vinyl	● UL		▲					
B-428	Polyester	● UL		▲					
B-430	Polyester		● UL	▲			▲		▲
B-432*	Polyester		● UL				▲		▲
B-433*	Polyester		● UL				▲		▲
B-435*	Polyester		● UL				▲		▲
B-437	Polyvinylfluoride	●							
B-439*	Vinyl		●	▲			▲		▲
B-459	Polyester		● UL						
B-472	Polyimide	●		▲					
B-473	Polyester		● UL						
B-483	Polyester		● UL						▲
B-486	Polyester	● UL		▲					
B-488	Polyester	● UL		▲					
B-489	Polyester	● UL		▲					
B-495*	Polyethylene naphthalate		● UL				▲		▲
B-498	Vinyl cloth	▲	▲	●					
B-499	Nylon cloth	● UL	▲	▲					▲
B-529	Polypropylene		●						▲
B-530	Tamper-resistant vinyl		●						▲
B-581	Vinyl		●						▲
B-582	Phosphorescent		●				▲		▲
B-584	Reflective		●				▲		▲
B-593	Polyester		●				▲		▲
B-595	Vinyl		●				▲		▲
B-717	Polyimide		● UL						
B-718	Polyimide		● UL						
B-719*	Polyimide		● UL						
B-724	Polyimide	●							
B-727	Polyimide		● UL						
B-854	ToughWash® metal detectable		●						
B-855	ToughWash® material		●						
B-7531*	Metallized polyester	●							
B-7536*	Polyester			●					
B-7546*	Void footprint polyester		● UL				▲		▲
B-7551*	Polyester			●					
B-7566*	Void footprint polyester		●				▲		▲
B-7576*	Void footprint polyester	● UL					▲		▲
B-7593*	Polyethylene		●				▲		▲
B-7596*	Vinyl			●					
B-7597*	Polyethylene	●							
B-7599*	Polyethylene tag	●							
B-7641	Low-smoke zero-halogen polyolefin		▲			●			
B-7643*	Thermoplastic polyether polyurethane	●				▲		▲	
B-7696*	Vinyl tag		●				▲		▲
B-8425*	Polypropylene		● UL						▲

View BradyID.com/techdata for TDS sheets on ribbon performance specifications.
 *This BMP®61 material also works in the BMP71 printer with media adapter.

● Recommended ribbon ▲ Acceptable ribbon
 UL These materials are UL recognized with its respective ribbon.



The IDXPERT printer has been discontinued, but for a limited time Brady will continue to stock the following labels for the printer.

General ID, 5S Lean, Facility and Safety ID (B-422, B-428, B-483, B-499 and B-595)

- **B-422 Polyester Material:** Permanent adhesive, good for powder-coated and textured surfaces. Best on flat surfaces. Temp. range: -40° F to 212° F (-40° C to 100° C). UL recognized.
- **B-428 Metallized Polyester Material:** Permanent adhesive, silver finish. Temp. range: -40° F to 176° F (-40° C to 80° C). UL recognized
- **B-483 Polyester Material:** Permanent adhesive for powder-coated and textured surfaces. Best on flat surfaces. Temp. range: -40° F to 248° F (-40° C to 120° C). UL recognized
- **B-499 Nylon Cloth Material:** Permanent adhesive. Pliable for rough or smooth surfaces. Temp. range: -94° F to 194° F (-70° C to 90° C). UL recognized
- **B-595 Indoor / Outdoor Vinyl Material:** Permanent adhesive, very pliable, good for rough surfaces and outdoor use. Temp. range: -40° F to 180° F (-40° C to 82° C). UL recognized

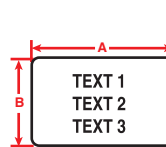

Figure 29



Figure 33

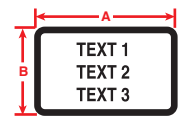

Figure 46
(Includes black border)

Diagram	Catalog #	B#	Material	Color	Label Width A Inch (mm)	Label Height B Inch (mm)	Labels Per Roll
B-422 Polyester Labels							
Fig. 29	X-7-422	B-422	Polyester	Black on White	0.500 (12.7)	0.500 (12.7)	350
Fig. 29	X-19-422	B-422	Polyester	Black on White	1.000 (25.4)	1.000 (25.4)	250
Fig. 29	X-132-422	B-422	Polyester	Black on White	1.500 (38.1)	1.250 (13.8)	250
Fig. 29	X-30-422	B-422	Polyester	Black on White	1.500 (38.1)	0.750 (19.1)	250
B-428 Metallized Polyester Labels							
Fig. 29	X-17-428-SV-BK	B-428	Polyester	Light Gray	1.000 (25.4)	0.500 (12.7)	500
Fig. 46	X-24-428-SVBB-BK	B-428	Polyester	Light Gray	1.130 (28.7)	0.500 (12.7)	500
Fig. 29	X-29-428-SV-BK	B-428	Polyester	Light Gray	1.500 (38.1)	0.500 (12.7)	500
Fig. 29	X-30-428-SV-BK	B-428	Polyester	Light Gray	1.500 (38.1)	0.750 (19.1)	325
Fig. 29	X-20-428-SV-BK	B-428	Polyester	Light Gray	2.000 (50.8)	1.000 (25.4)	100
B-483 Polyester Labels							
Fig. 29	X-17-483	B-483	Polyester	Black on White	1.000 (25.4)	0.500 (12.7)	500
Fig. 29	X-20-483	B-483	Polyester	Black on White	2.000 (50.8)	1.000 (25.4)	100
Fig. 29	X-61-483	B-483	Polyester	Black on White	2.000 (50.8)	0.500 (12.7)	100
B-499 Nylon Cloth Labels							
Fig. 29	X-130-499	B-499	Nylon Cloth	Black on White	0.375 (9.5)	0.750 (19.1)	300
Fig. 33	XC-375-499	B-499	Nylon Cloth	Black on White	0.375 (9.5)	20 ft. (6.1 m)	1 roll (cont.)
Fig. 33	XC-500-499	B-499	Nylon Cloth	Black on White	0.500 (12.7)	20 ft. (6.1 m)	1 roll (cont.)
Fig. 29	X-11-499	B-499	Nylon Cloth	Black on White	0.750 (19.1)	0.500 (12.7)	275
Fig. 33	XC-750-499	B-499	Nylon Cloth	Black on White	0.750 (19.1)	20 ft. (6.1 m)	1 roll (cont.)
Fig. 29	X-84-499	B-499	Nylon Cloth	Black on White	0.900 (22.9)	0.500 (12.7)	250
Fig. 33	XC-1000-499	B-499	Nylon Cloth	Black on White	1.000 (25.4)	20 ft. (6.1 m)	1 roll (cont.)
Fig. 29	X-162-499	B-499	Nylon Cloth	Black on White	1.500 (38.1)	0.500 (12.7)	165

General ID labels continued on next page.

General ID, 5S Lean, Facility and Safety ID (continued)



Figure 33



Diagram	Catalog #	B#	Material	Color	Label Width A Inch (mm)	Roll Length B Feet (m)	Labels Per Roll
B-595 Indoor / Outdoor Vinyl Film							
Fig. 33	XC-500-595-CL-BK	B-595	Vinyl	Black on Clear	0.500 (12.7)	25 (7.6)	1 roll (cont.)
Fig. 33	XC-750-595-CL-BK	B-595	Vinyl	Black on Clear	0.750 (19.1)	25 (7.6)	1 roll (cont.)
Fig. 33	XC-1000-595-CL-BK	B-595	Vinyl	Black on Clear	1.000 (25.4)	25 (7.6)	1 roll (cont.)
Fig. 33	XC-1500-595-CL-BK	B-595	Vinyl	Black on Clear	1.500 (38.1)	25 (7.6)	1 roll (cont.)
Fig. 33	XC-500-595-OR-BK	B-595	Vinyl	Black on Orange	0.500 (12.7)	30 (9.1)	1 roll (cont.)
Fig. 33	XC-750-595-OR-BK	B-595	Vinyl	Black on Orange	0.750 (19.1)	30 (9.1)	1 roll (cont.)
Fig. 33	XC-1000-595-OR-BK	B-595	Vinyl	Black on Orange	1.000 (25.4)	30 (9.1)	1 roll (cont.)
Fig. 33	XC-1500-595-OR-BK	B-595	Vinyl	Black on Orange	1.500 (38.1)	30 (9.1)	1 roll (cont.)
Fig. 33	XC-500-595-WT-BK	B-595	Vinyl	Black on White	0.500 (12.7)	30 (9.1)	1 roll (cont.)
Fig. 33	XC-750-595-WT-BK	B-595	Vinyl	Black on White	0.750 (19.1)	30 (9.1)	1 roll (cont.)
Fig. 33	XC-1000-595-WT-BK	B-595	Vinyl	Black on White	1.000 (25.4)	30 (9.1)	1 roll (cont.)
Fig. 33	XC-1500-595-WT-BK	B-595	Vinyl	Black on White	1.500 (38.1)	30 (9.1)	1 roll (cont.)
Fig. 33	XC-500-595-YL-BK	B-595	Vinyl	Black on Yellow	0.500 (12.7)	30 (9.1)	1 roll (cont.)
Fig. 33	XC-750-595-YL-BK	B-595	Vinyl	Black on Yellow	0.750 (19.1)	30 (9.1)	1 roll (cont.)
Fig. 33	XC-1000-595-YL-BK	B-595	Vinyl	Black on Yellow	1.000 (25.4)	30 (9.1)	1 roll (cont.)
Fig. 33	XC-1500-595-YL-BK	B-595	Vinyl	Black on Yellow	1.500 (38.1)	30 (9.1)	1 roll (cont.)
Fig. 33	XC-500-595-WT-RD	B-595	Vinyl	Red on White	0.500 (12.7)	30 (9.1)	1 roll (cont.)
Fig. 33	XC-750-595-WT-RD	B-595	Vinyl	Red on White	0.750 (19.1)	30 (9.1)	1 roll (cont.)
Fig. 33	XC-1000-595-WT-RD	B-595	Vinyl	Red on White	1.000 (25.4)	30 (9.1)	1 roll (cont.)
Fig. 33	XC-1500-595-WT-RD	B-595	Vinyl	Red on White	1.500 (38.1)	30 (9.1)	1 roll (cont.)
Fig. 33	XC-500-595-BL-WT	B-595	Vinyl	White on Blue	0.500 (12.7)	30 (9.1)	1 roll (cont.)
Fig. 33	XC-750-595-BL-WT	B-595	Vinyl	White on Blue	0.750 (19.1)	30 (9.1)	1 roll (cont.)
Fig. 33	XC-1000-595-BL-WT	B-595	Vinyl	White on Blue	1.000 (25.4)	30 (9.1)	1 roll (cont.)
Fig. 33	XC-1500-595-BL-WT	B-595	Vinyl	White on Blue	1.500 (38.1)	30 (9.1)	1 roll (cont.)
Fig. 33	XC-500-595-GN-WT	B-595	Vinyl	White on Green	0.500 (12.7)	30 (9.1)	1 roll (cont.)
Fig. 33	XC-750-595-GN-WT	B-595	Vinyl	White on Green	0.750 (19.1)	30 (9.1)	1 roll (cont.)
Fig. 33	XC-1000-595-GN-WT	B-595	Vinyl	White on Green	1.000 (25.4)	30 (9.1)	1 roll (cont.)
Fig. 33	XC-1500-595-GN-WT	B-595	Vinyl	White on Green	1.500 (38.1)	30 (9.1)	1 roll (cont.)
Fig. 33	XC-500-595-RD-WT	B-595	Vinyl	White on Red	0.500 (12.7)	30 (9.1)	1 roll (cont.)
Fig. 33	XC-750-595-RD-WT	B-595	Vinyl	White on Red	0.750 (19.1)	30 (9.1)	1 roll (cont.)
Fig. 33	XC-1000-595-RD-WT	B-595	Vinyl	White on Red	1.000 (25.4)	30 (9.1)	1 roll (cont.)
Fig. 33	XC-1500-595-RD-WT	B-595	Vinyl	White on Red	1.500 (38.1)	30 (9.1)	1 roll (cont.)

PermaSleeve® PS Polyolefin Wire Markers (B-342)

3:1 heat-shrinkable sleeves fit snugly around wire for identification and protection. Fade resistant and flame retardant.

• Meets specifications:

- SAE-AMS-DTL-23053/5 (Class 1)
- SAE-AS-81531
- MIL-STD-202
- RoHS compliant
- UL recognized

• Tested per:

- ASTM E162 and
- ASTM E662

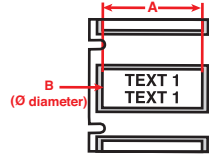

Figure 44

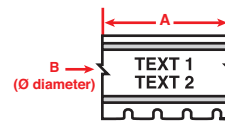

Figure 58



Diagram	Catalog #	B#	Color	Approx. Wire Gauge	Range of Wire Dia. Inch (mm)	Supplied Diameter B Inch (mm)	Recovered Diameter Inch (mm)	Sleeve Width A Inch (mm)	Sleeves Per Roll
B-342 Die Cut Sleeves									
Fig. 44	* XPS-125-1	B-342	Black on White	22 to 16	0.046-0.110 (1.2-2.8)	0.125 (3.2)	0.047 (1.2)	1.015 (25.8)	100
Fig. 44	* XPS-187-1	B-342	Black on White	20 to 10	0.062-0.150 (1.6-3.8)	0.187 (4.7)	0.062 (1.6)	1.015 (25.8)	100
Fig. 44	* XPS-250-1	B-342	Black on White	16 to 8	0.094-0.215 (2.4-5.5)	0.250 (6.4)	0.093 (2.4)	1.015 (25.8)	100
Fig. 44	* XPS-375-1	B-342	Black on White	12 to 4	0.125-0.320 (3.2-8.13)	0.375 (9.5)	0.125 (3.1)	1.015 (25.8)	100
B-342 Continuous Sleeve Tubing									
Fig. 58	* XPS-125-CONT	B-342	Black on White	22 to 16	0.046-0.110 (1.2-2.8)	0.125 (3.2)	0.047 (1.2)	8 ft. (2.45m)	1 roll (cont.)
Fig. 58	* XPS-187-CONT	B-342	Black on White	20 to 10	0.062-0.150 (1.6-3.8)	0.187 (4.7)	0.062 (1.6)	8 ft. (2.45m)	1 roll (cont.)
Fig. 58	* XPS-250-CONT	B-342	Black on White	16 to 8	0.094-0.215 (2.4-5.5)	0.250 (6.4)	0.093 (2.4)	8 ft. (2.45m)	1 roll (cont.)
Fig. 58	* XPS-375-CONT	B-342	Black on White	12 to 4	0.125-0.320 (3.2-8.13)	0.375 (9.5)	0.125 (3.1)	8 ft. (2.45m)	1 roll (cont.)
Fig. 58	* XPS-125-CONT-YL-BK	B-342	Black on Yellow	22 to 16	0.046-0.110 (1.2-2.8)	0.125 (3.2)	0.047 (1.2)	8 ft. (2.45m)	1 roll (cont.)
Fig. 58	* XPS-187-CONT-YL-BK	B-342	Black on Yellow	20 to 10	0.062-0.150 (1.6-3.8)	0.187 (4.7)	0.062 (1.6)	8 ft. (2.45m)	1 roll (cont.)
Fig. 58	* XPS-250-CONT-YL-BK	B-342	Black on Yellow	16 to 8	0.094 (2.4) - 0.215 (5.5)	0.250 (6.4)	0.093 (2.4)	8 ft. (2.45m)	1 roll (cont.)

* **WARNING:** Cancer www.P65Warnings.ca.gov

Repositionable Vinyl Cloth Wire and Cable Wraps (B-498)

Printer automatically repeats your text to fill the label for maximum readability. Special adhesive stays put, but marker can be removed and reapplied if necessary. Temp. range -40° F to 175° F (-40° C to 70° C). UL recognized.

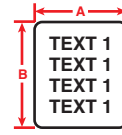

Figure 31



Diagram	Catalog #	B#	Material	Color	Approx. Wire Gauge*	Max Wire Dia. Inch (mm)	Label Width A Inch (mm)	Label Height B Inch (mm)	Labels Per Roll
B-498 Repositionable Vinyl Cloth Labels									
Fig. 31	X-7-498	B-498	Vinyl Cloth	Black on White	22 to 16	0.11 (2.8)	0.500 (12.7)	0.500 (12.7)	300
Fig. 31	X-11-498	B-498	Vinyl Cloth	Black on White	16 to 10	0.16 (4.0)	0.500 (12.7)	0.750 (19.1)	275
Fig. 31	X-163-498	B-498	Vinyl Cloth	Black on White	12 to 10	0.21 (5.3)	0.500 (12.7)	1.000 (25.4)	225
Fig. 31	X-19-498	B-498	Vinyl Cloth	Black on White	12 to 10	0.21 (5.3)	1.000 (25.4)	1.000 (25.4)	200
Fig. 31	X-18-498	B-498	Vinyl Cloth	Black on White	12 to 10	0.21 (5.3)	0.750 (19.1)	1.000 (25.4)	225
Fig. 31	X-103-498	B-498	Vinyl Cloth	Black on White	10 to 4	0.27 (6.9)	1.000 (25.4)	1.250 (31.8)	200
Fig. 31	X-162-498	B-498	Vinyl Cloth	Black on White	10 to 4	0.32 (6.9)	0.500 (12.7)	1.500 (38.1)	165
Fig. 31	X-31-498	B-498	Vinyl Cloth	Black on White	10 to 4	0.32 (6.9)	1.000 (25.4)	1.500 (38.1)	165
Fig. 31	X-21-498	B-498	Vinyl Cloth	Black on White	3 Gauge-2/0	0.53 (13.5)	1.000 (25.4)	2.500 (63.5)	95
Fig. 31	X-23-498	B-498	Vinyl Cloth	Black on White	3/0-400Kcmil	0.85 (21.6)	1.000 (25.4)	4.000 (101.6)	60

Self-laminating Vinyl Wire and Cable Markers (B-427)

Marker features a clear, non-printed area which wraps around and overlaminates the printed text. Printer automatically repeats your lines of text to fill the white print area. Resistant to abrasion, water, oil and solvents. Temp. range -40° F to 158° F (-40° C to 70° C), UL recognized.

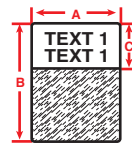

Figure 32



Diagram	Catalog #	B#	Material	Color	Approx. Wire Gauge*	Max Wire Dia. Inch (mm)	Label Width A Inch (mm)	Label Height B Inch (mm)	Print-On Height C Inch (mm)	Labels Per Roll
B-427 Self-laminating Vinyl Labels										
Fig. 32	XSL-11-427	B-427	Vinyl	Black on White	16 to 10	0.160 (4.0)	0.500 (12.7)	0.750 (19.1)	0.375 (9.5)	450
Fig. 32	XSL-96-427	B-427	Vinyl	Black on White	16 to 10	0.160 (4.0)	1.000 (25.4)	0.750 (19.1)	0.375 (9.5)	250
Fig. 32	XSL-17-427	B-427	Vinyl	Black on White	12 to 10	0.210 (5.3)	0.500 (12.7)	1.000 (25.4)	0.375 (9.5)	450
Fig. 32	XSL-18-427	B-427	Vinyl	Black on White	12 to 10	0.210 (5.3)	0.750 (19.1)	1.000 (25.4)	0.375 (9.5)	250
Fig. 32	XSL-19-427	B-427	Vinyl	Black on White	12 to 10	0.210 (5.3)	1.000 (25.4)	1.000 (25.4)	0.375 (9.5)	250
Fig. 32	XSL-133-427	B-427	Vinyl	Black on White	12 to 10	0.210 (5.3)	1.750 (44.5)	1.000 (25.4)	0.287 (7.29)	175
Fig. 32	XSL-102-427	B-427	Vinyl	Black on White	10 to 4	0.270 (6.9)	0.500 (12.7)	1.250 (31.8)	0.375 (9.5)	250
Fig. 32	XSL-103-427	B-427	Vinyl	Black on White	10 to 4	0.270 (6.9)	1.000 (25.4)	1.250 (31.8)	0.500 (12.7)	250
Fig. 32	XSL-115-427	B-427	Vinyl	Black on White	10 to 4	0.270 (6.9)	1.500 (38.1)	1.250 (31.8)	0.500 (12.7)	250
Fig. 32	XSL-29-427	B-427	Vinyl	Black on White	10 to 4	0.320 (8.1)	0.500 (12.7)	1.500 (38.1)	0.500 (12.7)	450
Fig. 32	XSL-30-427	B-427	Vinyl	Black on White	10 to 4	0.320 (8.1)	0.750 (19.1)	1.500 (38.1)	0.500 (12.7)	250
Fig. 32	XSL-31-427	B-427	Vinyl	Black on White	10 to 4	0.320 (8.1)	1.000 (25.4)	1.500 (38.1)	0.500 (12.7)	250
Fig. 32	XSL-32-427	B-427	Vinyl	Black on White	10 to 4	0.320 (8.1)	1.500 (38.1)	1.500 (38.1)	0.500 (12.7)	227
Fig. 32	XSL-134-427	B-427	Vinyl	Black on White	10 to 4	0.320 (8.1)	1.750 (44.5)	1.500 (38.1)	0.413 (10.49)	175
Fig. 32	XSL-21-427	B-427	Vinyl	Black on White	3 Gauge-2/0	0.530 (13.5)	1.000 (25.4)	2.500 (63.5)	0.750 (19.1)	100
Fig. 32	XSL-116-427	B-427	Vinyl	Black on White	3 Gauge-2/0	0.530 (13.5)	1.500 (38.1)	2.500 (63.5)	0.750 (19.1)	100
Fig. 32	XSL-23-427	B-427	Vinyl	Black on White	3/0-400 kcmil	0.850 (22.0)	1.000 (25.4)	4.000 (101.6)	1.000 (25.4)	85
Fig. 32	XSL-33-427	B-427	Vinyl	Black on White	3/0-400 kcmil	0.850 (22.0)	1.500 (38.1)	4.000 (101.6)	1.000 (25.4)	85
Fig. 32	XSL-34-427	B-427	Vinyl	Black on White	500-900 kcmil	1.30 (33.0)	1.500 (38.1)	6.000 (152.4)	1.500 (38.1)	50
Fig. 32	XSL-31-427-YL-BK	B-427	Vinyl	Black on Yellow	10 to 4	0.320 (8.1)	1.000 (25.4)	1.500 (38.1)	0.500 (12.7)	250
Fig. 32	XSL-21-427-YL-BK	B-427	Vinyl	Black on Yellow	3 Gauge-2/0	0.530 (13.5)	1.000 (25.4)	2.500 (63.5)	0.750 (19.1)	100
Fig. 32	XSL-23-427-YL-BK	B-427	Vinyl	Black on Yellow	3/0-400 kcmil	0.850 (22.0)	1.000 (25.4)	4.000 (101.6)	1.000 (25.4)	100

Terminal Repositionable Vinyl Cloth Material (B-498)

Specially designed narrow-width markers automatically set to fixed spacing and separation between legends and auto-rotate to top-down orientation for perfect alignment on terminal blocks. Temp. range -40° F to 175° F (-40° C to 80° C), UL recognized

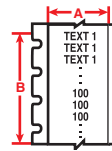

Figure 30

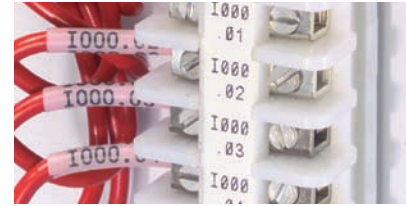

Diagram	Catalog #	B#	Material	Color	Label Width A Inch (mm)	Roll Length B Feet (m)	Labels Per Roll
B-498 Repositionable Vinyl Cloth Labels							
Fig. 30	XC-240-498	B-498	Vinyl Cloth	Black on White	0.240 (6.1)	20 (7.9)	1 roll (cont.)
Fig. 30	XC-318-498	B-498	Vinyl Cloth	Black on White	0.318 (8.1)	20 (7.9)	1 roll (cont.)
Fig. 30	XC-375-498	B-498	Vinyl Cloth	Black on White	0.375 (9.5)	20 (7.9)	1 roll (cont.)

Polyester Labels (B-422)

Permanent adhesive, good for powder-coated and textured surfaces making it ideal for patch panels, outlets and faceplate identification. Best on flat surfaces. Temp. range: -40° F to 212° F (-40° C to 100° C). UL recognized

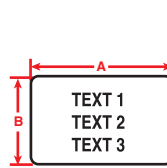

Figure 29

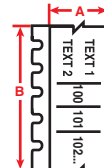

Figure 59



Diagram	Catalog #	B#	Material	Color	Sized To Fit	Label Width A Inch (mm)	Label Height B Inch (mm)	Labels Per Roll
B-422 Polyester Labels								
Fig. 59	XC-375-422	B-422	Polyester	Black on White	Label Punch Blocks or Multiple Ports on Cont. Tape	0.375 (9.530)	30 ft. (9.140 m)	1 roll (cont.)
Fig. 59	XC-475-422	B-422	Polyester	Black on White	Label Punch Blocks or Multiple Ports on Cont. Tape	0.475 (12.070)	30 ft. (9.140 m)	1 roll (cont.)
Fig. 29	X-7-422	B-422	Polyester	Black on White	Label Each Port	0.500 (12.700)	0.500 (12.700)	350
Fig. 29	X-17-422	B-422	Polyester	Black on White	Label Faceplate	1.000 (25.400)	0.500 (12.700)	500
Fig. 29	X-29-422	B-422	Polyester	Black on White	Label Faceplate	1.500 (38.100)	0.500 (12.700)	500

Racks, Bays, Frames and Data Center ID (B-422, B-483 and B-595)

- **B-422 Polyester Material:** Permanent adhesive, good for powder-coated and textured surfaces. Best on flat surfaces. Temp. range: -40° F to 212° F (-40° C to 100° C). UL recognized
- **B-483 Polyester Material:** Permanent adhesive for powder-coated and textured surfaces. Best on flat surfaces Temp. range: -40° F to 248° F (-40° C to 120° C). UL recognized
- **B-595 Indoor / Outdoor Vinyl Material:** Permanent adhesive, very pliable, good for rough surfaces and outdoor use, wide range of colors. Temp. range: -40° F to 180° F (-40° C to 82° C). UL recognized

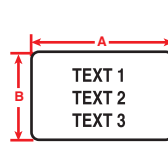

Figure 29

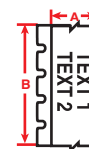

Figure 33



Diagram	Catalog #	B#	Material	Color	Label Width A Inch (mm)	Label Height B Inch (mm)	Labels Per Roll
B-422 Polyester Labels							
Fig. 29	X-17-422	B-422	Polyester	Black on White	1.000 (25.4)	0.500 (12.7)	500
Fig. 29	X-29-422	B-422	Polyester	Black on White	1.500 (38.1)	0.500 (12.7)	500
Fig. 29	X-30-422	B-422	Polyester	Black on White	1.500 (38.1)	0.750 (19.1)	250
Fig. 29	X-19-422	B-422	Polyester	Black on White	1.000 (25.4)	1.000 (25.4)	250
Fig. 33	XC-1000-422	B-422	Polyester	Black on White	1.000 (25.4)	30 ft. (9.1 m)	1 roll (cont.)
B-483 Polyester Labels							
Fig. 29	X-17-483	B-483	Polyester	Black on White	1.000 (25.4)	0.500 (12.7)	500
Fig. 29	X-61-483	B-483	Polyester	Black on White	2.000 (50.8)	0.500 (12.7)	100
Fig. 29	X-20-483	B-483	Polyester	Black on White	2.000 (50.8)	1.000 (25.4)	100
B-595 Indoor/Outdoor Vinyl Film							
Fig. 33	XC-500-595-YL-BK	B-595	Vinyl	Black on Yellow*	0.500 (12.7)	30 ft. (9.1 m)	1 roll (cont.)
Fig. 33	XC-1000-595-YL-BK	B-595	Vinyl	Black on Yellow*	1.000 (25.4)	30 ft. (9.1 m)	1 roll (cont.)
Fig. 33	XC-1500-595-YL-BK	B-595	Vinyl	Black on Yellow*	1.500 (38.1)	30 ft. (9.1 m)	1 roll (cont.)

*Red, orange, green, blue, white and clear are also available.



Brady Workstation

BradyID.com/s36



Brady Workstation

Simple. Efficient. Flexible.

Brady Workstation has revolutionized how you design and print signs and labels. When paired with the high-performance printing capabilities of a Brady printer, you get intuitive label set up for simple, efficient and flexible sign and label creation.

Simple

Brady Workstation offers an intuitive user interface and workflow so you're ready to get started, without in-depth training. With your Brady printer, you get real-time information about the material installed in the printer to make label set up easy.

Efficient

Each suite of apps is designed with you in mind, featuring built-in regulations, standards, pictograms, common phrases, data importation guidance, help functions and more.

Flexible

With all your design apps in one spot, switching between identification tasks becomes a breeze. And, Brady Workstation works with our complete benchtop printer offering and select portable printers. Visit Workstation.BradyID.com for the full printer compatibility list.

Software

Download your free 30-day trial



1. Download Brady Workstation at Workstation.BradyID.com.



2. Fill your workstation with the suites that best fit your needs.



3. Begin designing labels and printing them on your Brady printer!





Brady Workstation: Safety and Facility Identification Suite

Keep your facility safe and compliant. This suite features applications so you can easily create the custom signs, labels and pipe markers you need to add visual safety guidance to your facility.

Included apps:



Custom Designer
Complete, customized label creation and editing.



Arc Flash
Create NFPA compliant arc flash labels.



Express Signs
Create safety and facility signs in minutes with pre-defined templates and layouts.



Lean
Create common lean labels including gauge* and inventory labels.



Pipe Markers
Easily create ANSI / ASME compliant pipe markers using pre-defined templates.



Arrow Tape
Create arrow tape labels with pre-defined templates to show pipe flow direction.



Excel Import
Easily import Excel data right onto your labels.



Sequence
Create labels based on numeric and alphanumeric sequences.



Template Editor
Set elements on labels to be editable or locked.



Batch Print
Group files to print together.



Label Settings
Set default horizontal and vertical printing adjustments when using specific supplies with specific printers.



Print Partner
Quickly create labels by filling in a template and printing.



Manage Files
Manage saved files from one screen, with options to preview, categorize and delete file.



Network Printers
Connect to your printers via IP address or DNS address.



Arc flash labels



Safety labels



Facility signs



Equipment labels



Pipe markers



Lean / 5S labels and more

Catalog #	Description
BWS-SFIDS-NA-EM	Email with activation code
BWS-SFIDS-NA-CD	CD

▶ **Free 30-day trial at**
Workstation.BradleyID.com/SFID

Software

Additional safety and facility identification software

For more specialized identification projects, you can add on these suites and apps:



Lockout Writer App

This intuitive tool allows you to create, store and print simple lockout procedures, associated tags and energy source labels quickly and easily.

Catalog #	Description
BWRK-LOW-DWN	Email activation code
BWRK-LOW-CD	CD



GHS Chemical Identification App

We've streamlined the label creation process so you can easily enter the data once from your SDS sheets, then create and print GHS label on demand. You can also auto-populate your GHS label using the built-in chemical database.

Catalog #	Description
BWRK-GHS-DWN	Email activation code



Basic Label Design Suite

Use this free software option to get started designing your labels. You get basic formatting capabilities, graphics and simple barcode libraries. Included apps:

- Custom Designer LITE
- Excel Import
- Sequence
- Batch Print
- Label Settings
- Manage Files
- Network Printers

Free download at Workstation.BradleyID.com/FREE

* BBP®37 Printer required to cut out circular-shaped gauge labels.

BradyID.com/s36



Brady Workstation: Product and Wire Identification Suite

When you need to create product labels, wire and cable markers and panel labels, this suite is your go-to solution. It allows you to create basic text labels or complex labels with graphics and custom formatting, as well as serialize and import data.

Included apps:



Custom Designer
Complete, customized label creation and editing.



Text Labels
Simple designing for text-only wire and cable labels.



Asset Tags
Create the asset tags or asset location labels you need.



Patch Panel
Quickly identify patch panel ports and associated cables.



Terminal Block
Identify terminal blocks and create associated wire markers.



Excel Import
Easily import Excel data right onto your labels.



Advanced Import
Import data from sources beyond Excel onto your labels.



Sequence
Labels based on numeric and alphanumeric sequences.



Advanced Sequence
Create dependent and complex sequences for label creation.



Flip Flop
Automatically swap text items horizontally or vertically.



Template Editor
Set elements on labels to be editable or locked.



Batch Print
Group files to print together.



Label Settings
Set default horizontal and vertical printing adjustments when using specific supplies and printers.



Print Partner
Quickly create labels by filling in a template and printing.



Manage Files
Manage saved files from one screen, with options to preview, categorize and delete.



Network Printers
Connect to your printers via IP address or DNS address.



Component labels



Wire ID labels



PermaSleeve® wire markers



Rating plate labels

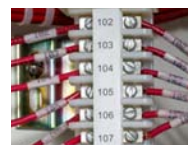

Terminal block labels



And more

Software

Catalog #	Description
BWS-PWIDS-EM	Email activation code
BWS-PWIDS-CD	CD

▶ **Free 30-day trial at**
Workstation.BradyID.com/PWID

Software for your product and wire identification workflow

The following suites are designed to improve and automate your printing and labeling process:



Print Partner Suite

This suite includes everything you need to fill-in your templates and print, including importing data from a variety of supported data sources or automatically generating sequential data for your labels.

- Excel Import
- Advanced Sequence
- Advanced Import
- Print Partner
- Sequence
- Network Printers

Catalog #	Description
BWS-PPS-EM	Email activation code
BWS-PPS-CD	CD
BWS-PPS-EM-VOL	Email with volume license activation code
BWS-PPS-CD-VOL	Volume license CD



Scan and Print Suite

This suite can solve your workflow needs by consuming data from a barcode scanner, keyboard or custom script to populate your label templates as part of a labeling workflow.

- Custom Designer
- Label Settings
- Text Labels
- Manage Files
- Template Editor
- Network Printers
- Scan and Print

Catalog #	Description
BWS-SPS-EM	Email activation code
BWS-SPS-CD	CD



Automation Suite

Get the power to fully automate your label printing with this suite. Easily set up templates and import data to make label creation an automated, error-free process.

- Custom Designer
- Label Settings
- Data Automation
- Manage Files
- Template Editor
- Network Printers

Catalog #	Description
BWS-DAS-EM	Email activation code
BWS-DAS-CD	CD

Manage your facility and assets

Keeping your facility running smoothly can be a time consuming and exhaustive task. Add software to the mix to make sure you know what you have, where you have it and how to keep it compliant.

LINK360® Software

Manage the full lifecycle of visual procedures for lockout tagout, confined space entry and maintenance. This cloud-based software centralizes your data, allowing multiple users and multiple sites access to procedures at any time. Mobile apps allow you to access, modify and verify procedures on the go using a range of mobile devices. Dashboards and reports summarize your program at a glance and keep you informed of audits coming due.

With LINK360 software, you can:

- Cloud-based software allows for program scalability and access from mobile and tablet devices (iOS and Android)
- User-defined permission for viewing, editing and approving helps ensure the correct people are doing the correct activities
- Pre-defined templates and standardized procedures allow for multi-site standardization
- Workflow and responsibility assignments for sites, areas and equipment improves employee accountability around machine safety and productivity
- Audit alerts, notifications and detailed reporting help companies keep information up to date

▶ [Request a demo at BradyID.com/Services](https://BradyID.com/Services)



Software

NetDoc® Network Cable Management Software

Make your job easier and more efficient with NetDoc Cable Management Software. As cable networks grow and become more complex, proper documentation is key to knowing what you have, where it is and what it's connected to. With NetDoc software, you can document and identify every aspect of your network, including cables, patch panels, racks, assets and much more.

Catalog #	Description
ND-1USER	1 license
ND-5USER	5 licenses
ND-SITE	1000 licenses

▶ [Request a demo at BradyID.com/Netdoc](https://BradyID.com/Netdoc)



Lockout Tagout

BradyID.com/s36

Lockout tagout: A critical safety regulation

Lockout tagout is an important safety component that is critical to safeguarding workers around the machinery and equipment they operate, service and maintain. This important safety practice involves de-energizing electrical circuits, closing valves, neutralizing extreme temperatures and securing moving parts so hazardous energy isn't re-introduced while equipment is being serviced.

An effective lockout tagout program is most successful when it includes the complete safety picture – locks, tags and devices — as well as proper lockout procedures, program documentation, employee training, periodic inspections or other procedural elements.

Benefits of a lockout tagout program

- **Saving lives:** Preventing an estimated 250,000 incidents, 50,000 injuries and 120 fatalities annually
- **Cutting costs:** Significantly decreasing lost employee time and insurance costs
- **Improving productivity:** Reducing equipment downtime



Regulatory requirements

OSHA 29CFR 1910.147 – Control of Hazardous Energy

General industry workers performing servicing and/or maintenance on machines or equipment and who are exposed to the unexpected energization, startup or release of hazardous energy.

OSHA 29CFR 1910.333 – Electrical Safety

Safety-related work practices shall be employed to prevent electric shock or other injuries resulting from either direct or indirect electrical contacts, when work is performed near or on equipment or circuits which are or may be energized.

ANSI Z244.1 (2016) – Lockout Tagout and Alternative Methods

A voluntary national consensus standard that represents several industry hazardous energy control best practices and also promotes greater flexibility through the use of alternative methods based on risk assessments and application of the hazard control hierarchy.

Lockout tagout is the fifth most cited OSHA violation, with 2,944 violations during fiscal year 2018

Top violations involve:

- | | |
|-------------------|-------------------------------------|
| 1910.147(c)(4)(i) | Requirements for General Procedures |
| 1910.147(c)(1) | Program Requirements |
| 1910.147(c)(6)(i) | Inspecting Procedures |
| 1910.147(c)(7)(i) | Training Requirements |
| 1910.147(d) | Notifying affected employees |

Go beyond compliance with the *Expanded Guide to Lockout Tagout*

Download the guidebook to learn more about the six essential elements of lockout tagout.

▶ [Download at BradyID.com/lockouttagout](https://bradyid.com/lockouttagout)



Six Essential Elements of Lockout Tagout



1. Program and policy

A written lockout document establishes and explains the elements of your program. It's important to take into account not only OSHA's guidelines, but also custom requirements for your employees that ensure they can understand and apply the program to their workday.



2. Machine- or task-specific procedures

Lockout procedures should be formally documented and should easily identify the equipment covered. They should also detail the specific steps necessary for shutting down, isolating, blocking and securing equipment to control hazardous energy, and include steps for the placement, removal and transfer of lockout tagout devices.



3. Identifying and marking energy isolation points

Locate and identify all energy control points, including valves, switches, breakers and plugs, with permanently placed and standardized labels or tags.



4. Training and periodic inspections and audits

Train authorized, affected and other employees, communicate processes and conduct periodic inspections. Training should include OSHA requirements and specific program elements, such as your machine-specific procedures.



5. Provide proper lockout devices

Provide employees with the necessary devices to keep them safe. There are many products on the market, and selecting the most appropriate solution for your application is the key to lockout effectiveness. It's important to document and use devices that best fit each lockout point.



6. Sustainability

Annually review, revise and update your program and procedures to create a safety culture that proactively addresses lockout tagout. This allows your company to focus on maintaining a world-class program, instead of starting from scratch each year and reacting only when something goes wrong.

Lockout Tagout Procedures

BradyID.com/s36

Lockout Tagout Procedures

There are a variety of components in a visual lockout tagout procedure that will help ensure your employees will get home safe. Use this helpful guide to determine what elements are required for compliance, and best practices to complete an even safer lockout procedure.

OSHA Regulation

29 CFR 1910.147 (c)(4)

Machine-specific lockout tagout procedures are required for equipment having more than one energy source, as well as for much equipment having a single energy source.

Lockout Tagout

Lockout/Tagout Posted Procedure

ID#: 5879	Facility: Brady Good Hope - Production	Location: Boiler Room
Created: 7/6/2018	Description: Boiler #1	
Revised: 7/6/2018		

4 Lockout Points

Note: This machine is capable of generating extremely high temperatures. Allow it to return to room temperature before proceeding Confined Space. Authorized personnel only. Permits are required before entering. Follow all Confined Space procedures. Piping systems can store energy hydraulically. Ensure pressures are isolated and/or have been relieved before proceeding.

MCC 3 Column 3 Bucket A

EAST VIEW

NORTH VIEW

Step #	Action	Info	Verification
1	Electrical The E-1 Disconnect is located on the East side of the machine on the MCC panel Column 3 bucket A. Turn Disconnect to the off position and lock out.	Use a Lock and hasp device.	Attempt to restart at control panel.
2	Gas The G-1 Ball Valve is located on the East side of the machine. Turn Valve to the off position and lock out.	Use a Ball valve lockout device.	Verify pressure has bled off.
3	Water The W-1 Butterfly Valve Lockout is located on the East side of the machine. Turn the valve to the closed position and lock out.	Use a Lock and hasp device.	Verify pressure has bled off.
4	Water The W-2 Butterfly Valve Lockout is located on the East side of the machine. Turn the valve to the closed position and lock out.	Use a Lock and hasp device.	Verify pressure has bled off.

- 1 Best practice:** Company logo
- 2 Best practice:** Machine-specific equipment ID number
- 3 Required:** Facility name, location, equipment name
- 4 Best practice:** Number of lockout points
- 5 Best practice:** The caution statement is where additional hazards and noteworthy information can be communicated
- 6 Best practice:** Pictures of equipment displaying location of each energy source.
- 7 Required:** While having corresponding energy source tags mounted on equipment and indicated on the lockout procedure is considered "best practice," lockout procedures are required to identify energy sources and magnitude. (OSHA1910.147(d)(1))
- 8 Required:** Action steps to isolate energy and location of isolation points. These must include procedural steps for shutting down, isolating, blocking and securing equipment to control hazardous energy. They also must include steps for the use of lockout devices and their responsibility. 1910.147(c)(4)(ii)(B-C)
- 9 Required:** Verification is required on every step of your lockout procedure. This is how your employees will know whether or not the energy source is truly isolated and at a zero energy state. 1910.147(c)(4)(ii)(D)
- 10 Required:** Purpose, scope and enforcement of lockout tagout procedure must be included on Physical procedure. 1910.147(c)(4)(ii)
- 11 Required:** A sequential procedure for shutdown, locking/tagging and testing must be included on the lockout procedure. 1910.147 App A
- 12 Required:** A sequential procedure to restore equipment to service must be included on the lockout procedure. 1910.147 App A

Lockout Tagout Procedure

Purpose: To protect authorized employees against unexpected or unplanned activation of equipment or energy while servicing equipment.

Scope: Utilize this procedure for all scheduled PM shutdowns, any maintenance task that requires you to place your body in harms way of the equipment, or if you have to leave the area while the equipment is in service.

Enforcement: Failure to properly follow lockout-tagout procedure will result in corrective action.

#	STEP	DESCRIPTION
	11	SHUTDOWN, LOCK, TAG & TEST SEQUENCE
1	Notify Employees	Notify all affected employees that servicing or maintenance is required on a machine or equipment, and that the machine or equipment must be shut down and locked out to perform the servicing or maintenance.
2	Review Lockout Procedure	The authorized employee shall refer to the company procedure to identify the type and magnitude of the energy that the machine or equipment utilizes, shall understand the hazards of the energy, and shall know the methods to control the energy.
3	Perform Machine Stop	If the machine or equipment is operating, shut it down by the normal stopping procedure (depress the stop button, open switch, close valve, etc.). Reference machine operating procedure for normal shutdown.
4	Isolate Energy	Follow graphical lockout-tagout procedure from top to bottom to de-activate the energy (isolating device(s)) so that the machine or equipment is isolated from the energy source(s). NOTE: It may be necessary to disengage the non-isolatable energy sources before isolating the lockable energy sources. (i.e. lower the machine to lowest position before locking out.)
5	Lockout Energy	Lockout and tagout the energy isolating device(s) with assigned lock(s) and tag(s).
6	Disipate Energy	Stored or residual energy (such as that in capacitors, springs, elevated machine members, rotating flywheels, hydraulic systems as well as air, gas, steam, or water pressure, etc.) must be dissipated or restrained by methods such as grounding, repositioning, blocking, bleeding down, etc.
7	Attempt Restart	Ensure that the equipment is disconnected from the energy sources by first checking that no personnel are exposed, then verify the isolation of the equipment by operating the push button or other normal operating controls or by testing to make certain the equipment will not operate. Caution: Return operating controls to neutral or "off" position after verifying the isolation of the equipment.

#	STEP	DESCRIPTION
	12	RESTORE TO SERVICE SEQUENCE
1	Check Machine	Check the machine or equipment and the immediate area around the machine to ensure that nonessential items have been removed and that the machine or equipment components are operationally intact.
2	Check Area	Check the work area to ensure that all employees have been safely positioned or removed from the area.
3	Verify Machine	Verify that the controls are in neutral.
4	Remove Lockout	Remove the locks, tags and lockout devices and re-energize the machine or equipment. In reverse order, follow all of the steps from the visual lockout-tagout procedure found on the previous page. Note: The removal of some forms of blocking may require re-energization of the machine before safe removal.
5	Notify Employees	Notify affected employees that the servicing or maintenance is completed and the machine or equipment is ready for use.

Lockout Tagout Services through Brady Safety Services



With a continually changing workforce, and frequent enhancements to processes and technology, there is a need in the industry to efficiently develop and train new workers to keep operations running smoothly. Having a sustainable lockout tagout program in place allows you to bridge the knowledge gap and improve safety throughout your facility.

Lockout Services include:

- Lockout tagout machine inventory
- Visual lockout procedure writing
- Lockout tagout procedure audit
- Lockout tagout training, including general / affected, authorized and train-the-trainer programs
- Alternative method procedures/minor servicing
- Job safety analysis
- Lockout tagout program development
- Lockout tagout gap analysis
- Time- and material-based services

▶ For more information visit BradyID.com/Services



▶ Request a demo at BradyID.com/Services

Create Your Own Procedures

LINK360® Software

Brady's LINK360® cloud based software offers procedure creation, procedure maintenance, audit reminders and more in order to manage, store and sustain machine safety and procedural information. It includes three centers that address common areas of focus when operating your equipment safely: Lockout Tagout, Confined Space and Reliability / Maintenance.

With Link360 software, you can:

- Create and update procedures and permits
- Facilitate reviews, comments and approvals
- Setup regularly scheduled audit processes and reminders
- Time-stamping and record keeping
- Print lockout tags containing equipment-specific information

The LINK360 advantage:

- Cloud-based software allows for program scalability and access from mobile and tablet devices
- User-defined permission for viewing, editing and approving helps ensure the correct people are doing the correct activities
- Pre-defined templates and standardized procedures for multi-site standardization
- Workflow and responsibility assignments for sites, areas and equipment improves employee accountability around machine safety and productivity
- Audit alerts, notification and detailed reporting help companies keep information up to date



▶ Download a 30-day trial at Workstation.BradlyID.com

Lockout Tagout Procedures

BradyID.com/s36

Lockout Tagout Procedure Accessories



Fluorescent Protective Envelopes

- Clear envelopes with fluorescent edging, great for color-coding lockout procedures and other shop information
- Durable 8 gauge vinyl construction withstands harsh environments
- Ideal for indoor or outdoor use

Catalog #	Color	Size	Qty.
56941	Fluorescent Green	9 in. x 9 in.	25
56945	Fluorescent Green	9 in. x 12 in.	25
56942	Fluorescent Orange	9 in. x 9 in.	25
56946	Fluorescent Orange	9 in. x 12 in.	25
56944	Fluorescent Yellow	9 in. x 9 in.	25
56948	Fluorescent Yellow	9 in. x 12 in.	25



Magnetic Backed
Open-End



Adhesive Backed
Open-End

Adhesive and Magnetic Backed Envelopes

- Made of non-glare clear vinyl material
- Protects tags and cards on machinery, valves, switches, controls, and more
- Size: 8.5 in. x 11 in.

Catalog #	Color	Qty.
50961	Adhesive Backed Envelopes	10
50962	Magnetic Backed Envelopes	10



Lockout Procedure Station

- Silk-screened backboard made from durable polystyrene
- Includes pre-drilled holes and hardware for wall mounting
- 1.5 in. 3-ring binder
- Size: 20 in. x 14 in. x 4.5 in.

Catalog #	Description
LOSP22	Lockout Procedure Station With Binder and 25 Forms
99289	Lockout Procedure Station With Binder Only
LOSB1	Lockout Procedure Binder Only
LOSF5	Lockout Procedure Forms (25/pk)

Lockout Tagout



Lockout Clip Board

- Heavy-duty, clipboard conveniently carries procedures and hardware directly to the lockout location
- Clipboard can also be hung in place using attached strap
- Lockout safety tips on the back
- Procedures, locks and hasps sold separately

Catalog #	Color	Qty.
LOCB	Lockout Clip Board	1

May we also suggest:



Energy Source Tags
View page 206



Lockout Tagout Signs
View page 504



Lockout Safety Labels
View page 392

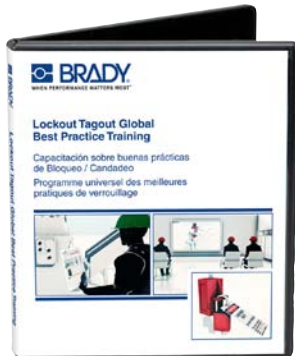

Lockout Tagout Safety Training Video: Global Best Practice Training

- Comprehensive training video features targeted regulatory and compliance content
- 5 languages included: English, Spanish, French, Portuguese and Simplified Chinese
- Includes instructor's guide, employee quiz and 25 min video that:
 - Clearly defines and explains lockout tagout
 - Overviews compliance standards and regulations from countries around the world
 - Outlines an effective four-step lockout tagout program for employers
 - Covers important subtopics in-depth such as handling group lockout and shift changeovers
 - Bonus feature: 19 short installation videos on how to use some of the most common lockout devices

Catalog #	Description
132427	LOTO Global Training Video USB
833918	LOTO Global Training Video USB - European Supplies information in English, French, Dutch, German, Portuguese, Italian, Spanish, Turkish, Polish and Russian



Lockout Tagout Handbook

- 16-page training booklet with quiz instructs workers how to protect themselves from hazardous energy

Catalog #	Description	Qty.
66219	Lockout Tagout Handbook	10



Lockout Safety Training Booklet

- 16-page training booklet covers the basics of lockout tagout safety

Catalog #	Description	Qty.
2112-TEN	Lockout Safety	10
2112	Lockout Safety	25
2112SP-TEN	Lockout Safety - Spanish	10
2112SP	Lockout Safety - Spanish	25



Wallet Safety Cards

- Wallet size card contains important reminders for lockout safety

Catalog #	Description	Qty.
LOSC13	English Wallet Card	10
LOSC13 BI	English/Spanish Wallet Card	10

Lockout Tagout

OSHA Training Requirements:

Authorized Employees

Those who perform servicing or maintenance must be trained to:

- Recognize hazardous energy sources and understand the energy type and magnitude
- Identify and properly operate the applicable energy-isolating devices
- Safely apply and remove lockout tagout devices
- Authorized employees must undergo an annual review to ensure they fully understand their responsibilities under the program

Affected Employees

Those who operate the machinery or work in the area where LOTO is performed must be trained to:

- Recognize when lockout tagout activities are in progress
- Understand the purpose of the energy control program and the importance of not tampering with lockout tagout devices when encountered in the workplace

Additional Requirements

- Employers must document when training took place, who attended, and the topics covered
- Employees must be retrained under the following situations:
 - Employee assigned to new job
 - Change made to energy control policies or procedures
 - Machinery installed or modified, presenting a new hazard
 - Whenever the employer has reason to believe that there are problems with the employee's understanding or use of the procedures
- Additional training is required when using tagout instead of lockout. See Section (C)(7)(ii) in the 1910.147 standard.

Lockout Padlocks

BradyID.com/s36

Lockout Padlocks

Although padlocks may seem like a commonplace device, the durability and reliability of your padlocks is critical to the safety of your employee. Brady provides a full line of padlocks that withstand harsh environmental conditions, rough handling and provide maximum safety.



Nylon Lockout Padlocks

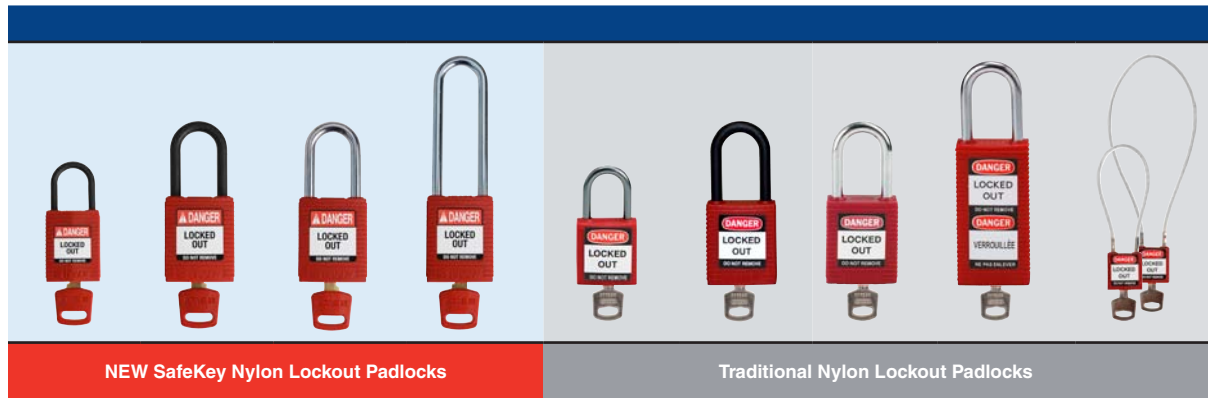

NEW SafeKey Nylon Lockout Padlocks

Traditional Nylon Lockout Padlocks

	SafeKey Compact Padlocks	SafeKey Padlock with Nylon Shackle	SafeKey Padlock with Steel Shackle	SafeKey Padlock with 3 in. Shackle	Compact Nylon Padlocks	Nylon Padlock with Nylon Shackle	Nylon Padlock with Steel Shackle	Long-Body Nylon Padlock	Compact Cable Nylon Padlocks
Features	Advanced security locking mechanism, color matched keys, compact size	Advanced security locking mechanism, color matched keys, non-conductive nylon body and shackle	Advanced security locking mechanism, color matched keys, standard size	Advanced security locking mechanism, color matched keys, 3 inch shackle	Traditional pin tumbler locking mechanism, chrome / nickel plated keys, compact size	Traditional pin tumbler locking mechanism, chrome / nickel plated keys, non-conductive nylon body and shackle	Traditional pin tumbler locking mechanism, chrome / nickel plated keys, standard size	Traditional pin tumbler locking mechanism, chrome / nickel plated keys, 3 in. body to display additional identification	Traditional pin tumbler locking mechanism, chrome / nickel plated keys, compact body and flexible cable shackle
Main application	Electrical applications and small spaces	General safety and electrical applications	General safety applications	General safety applications requiring a large shackle clearance	Electrical applications and small spaces	General safety and electrical applications	General safety applications	General safety applications	Small spaces and multi-locking points in electrical applications
Non-conductive	Yes	Yes	Yes	Yes	Yes	Yes	Yes	Yes	Yes
Non-sparking	Yes	Yes	No	No	No	Yes	No	No	No
Body (H x W)	Nylon body 1.7 in. x 1.25 in.	Nylon body 1.8 in. x 1.5 in.	Nylon body 1.8 in. x 1.5 in.	Nylon body 1.8 in. x 1.5 in.	Nylon body 1.4 in. x 1.2 in.	Nylon body 1.75 in. x 1.5 in.	Nylon body 1.75 in. x 1.5 in.	Nylon body 3 in. x 1.5 in.	Nylon body 1.4 in. x 1.2 in.
Shackle	Plastic polymer shackle Height: 1.0 in. Diameter: 0.17 in.	Plastic polymer shackle Height: 1.5 in. Diameter: 0.25 in.	Steel shackle Height: 1.5 in. Diameter: 0.25 in.	Steel shackle Height: 3.0 in. Diameter: 0.25 in.	Aluminum shackle Height: 1.0 in. Diameter: 0.19 in.	Nylon shackle Height: 3.0 in. Diameter: 0.25 in.	Steel shackle Height: 1.5 in. Diameter: 0.25 in.	Steel shackle Height: 1.5 in. Diameter: 0.25 in.	Flexible cable 7.87 in. or 15.75 in. length
Colors	9 colors	9 colors	9 colors	9 colors	9 colors	9 colors	9 colors	9 colors	9 colors
Key Retaining	No	Yes	Yes	Yes	Yes	Yes	Yes	Yes	Yes
Key Codes	100,000+	100,000+	100,000+	100,000+	Up to 15,000	Up to 15,000	Up to 15,000	Up to 15,000	Up to 15,000
Keying	Keyed Different Keyed Alike Master Keyed* Grand Master Keyed*	Keyed Different Keyed Alike Master Keyed* Grand Master Keyed*	Keyed Different Keyed Alike Master Keyed* Grand Master Keyed*	Keyed Different Keyed Alike Master Keyed* Grand Master Keyed*	Keyed Different Keyed Alike Master Keyed* Grand Master Keyed*	Keyed Different Keyed Alike Master Keyed* Grand Master Keyed*	Keyed Different Keyed Alike Master Keyed* Grand Master Keyed*	Keyed Different Keyed Alike Master Keyed* Grand Master Keyed*	Keyed Different Keyed Alike Master Keyed* Grand Master Keyed*
Engraving Available	Body (4 sides) and key	Body (4 sides) and key	Body (4 sides) and key	Body (4 sides) and key	Body (4 sides) and key	Body (4 sides) and key	Body (4 sides) and key	Body (4 sides) and key	Body (4 sides) and key
Includes	1 key and labels (EN, FR, SP)	1 key and labels (EN, FR, SP)	1 key and labels (EN, FR, SP)	1 key and labels (EN, FR, SP)	1 key and labels (EN, FR, SP)	1 key and labels (EN, FR, SP)	1 key and labels (EN, FR, SP)	1 key and labels (EN, FR, SP)	1 key and labels (EN, FR, SP)

*Available as custom.

Lockout Tagout

Regulations

1910.147(c)(5) OSHA Lockout Device Requirements state that lockout devices must:

- Be provided by the employer and be standardized by size, shape or color
- Be distinguishable from locks used for other purposes. Lockout locks should only be used for lockout
- Identify the individual who applied the lock (both tags and lock labels are acceptable for this purpose)
- Be capable of withstanding the usage environment and be strong enough to prevent removal except by using excessive force with special tools, such as bolt cutters
- Most importantly, whenever lockout devices are applied, they must remain under the exclusive control of the individual who attached them. No employee should be able to open a lock attached by someone else

Aluminum and Steel Lockout Padlocks



NEW SafeKey Aluminum Lockout Padlocks

Traditional Aluminum Lockout Padlocks

Traditional Steel Lockout Padlocks

	SafeKey Aluminum Padlocks	Compact Aluminum Padlocks	Aluminum Padlocks	Laminated Steel Padlocks	Key-Retaining Laminated Steel Padlocks
Features	Advanced security locking mechanism, color matched keys, superior corrosion resistance	Traditional pin tumbler locking mechanism, chrome / nickel plated keys, compact, superior corrosion resistance	Traditional pin tumbler locking mechanism, chrome / nickel plated keys, superior corrosion resistance	Traditional pin tumbler locking mechanism, chrome / nickel plated keys, superior physical and corrosion resistance	Traditional key-retaining pin tumbler locking mechanism, chrome / nickel plated keys, superior physical and corrosion resistance
Main application	Ideal for indoor and outdoor use and heavy-duty applications	Small space applications	Outdoor, industrial safety, food and beverage applications (FDA approved lubricant in cylinder)	Industrial safety and severe physical environments	Industrial safety and severe physical environments
Non-conductive	No	No	No	No	No
Non-sparking	No	No	No	No	No
Body (H x W)	Aluminum body 1.8 in. x 1.5 in.	Aluminum body 1.25 in.	Aluminum body 1.6 in.	Steel body 1.33 in.	Steel body 1.2 in.
Shackle	Steel shackle Height: 1.5 in. or 3.0 in. Diameter: 0.25 in.	Steel shackle Height: 1.0 in. Diameter: 0.25 in.	Steel shackle Height: 1 in., 1.5 in. or 3 in. Diameter: 0.25 in.	Steel shackle Height: 0.75 in. or 2 in. Diameter: 0.27 in.	Steel shackle Height: 0.75 in., 2 in. or 3 in. Diameter: 0.27 in.
Colors	9 colors	9 colors	9 colors	9 colors	9 colors
Key Retaining	No	No	No	No	Yes
Key Codes	100,000+	Up to 15,000	Up to 15,000	Up to 15,000	Up to 15,000
Keying	Keyed Different Keyed Alike Master Keyed* Grand Master Keyed*	Keyed Different Keyed Alike Master Keyed* Grand Master Keyed*	Keyed Different Keyed Alike Master Keyed* Grand Master Keyed*	Keyed Different Keyed Alike Master Keyed* Grand Master Keyed*	Keyed Different Keyed Alike Master Keyed* Grand Master Keyed*
Engraving Available	Body (4 sides) and key	Body (4 sides) and key	Body (4 sides) and key	Body (4 sides) and key	Body (4 sides) and key
Includes	1 key (labels sold separately)	2 keys (labels sold separately)	2 keys (labels sold separately)	2 keys (labels sold separately)	1 key (labels sold separately)

*Available as custom.

Lockout Tagout

Lockout Padlocks

BradyID.com/s36

new Brady SafeKey Lockout Padlocks

With this innovatively designed padlock, you get up to 700% more unique key possibilities than a standard safety padlock, without sacrificing a secure lockout. It's all in the forward-thinking design of the locking mechanism and unique key blade that gives you more precision and control in your lockout program. With that level of precision, you're covered from your simple to highly complex lockout needs. You also get:

- Fast identification with the color-matched key
- Easy operation with extra smooth key insertion and removal — even when wearing gloves!
- Years of use with the low-friction locking mechanism that helps maintain key integrity
- Excellent durability in industrial environments



Lockout Tagout

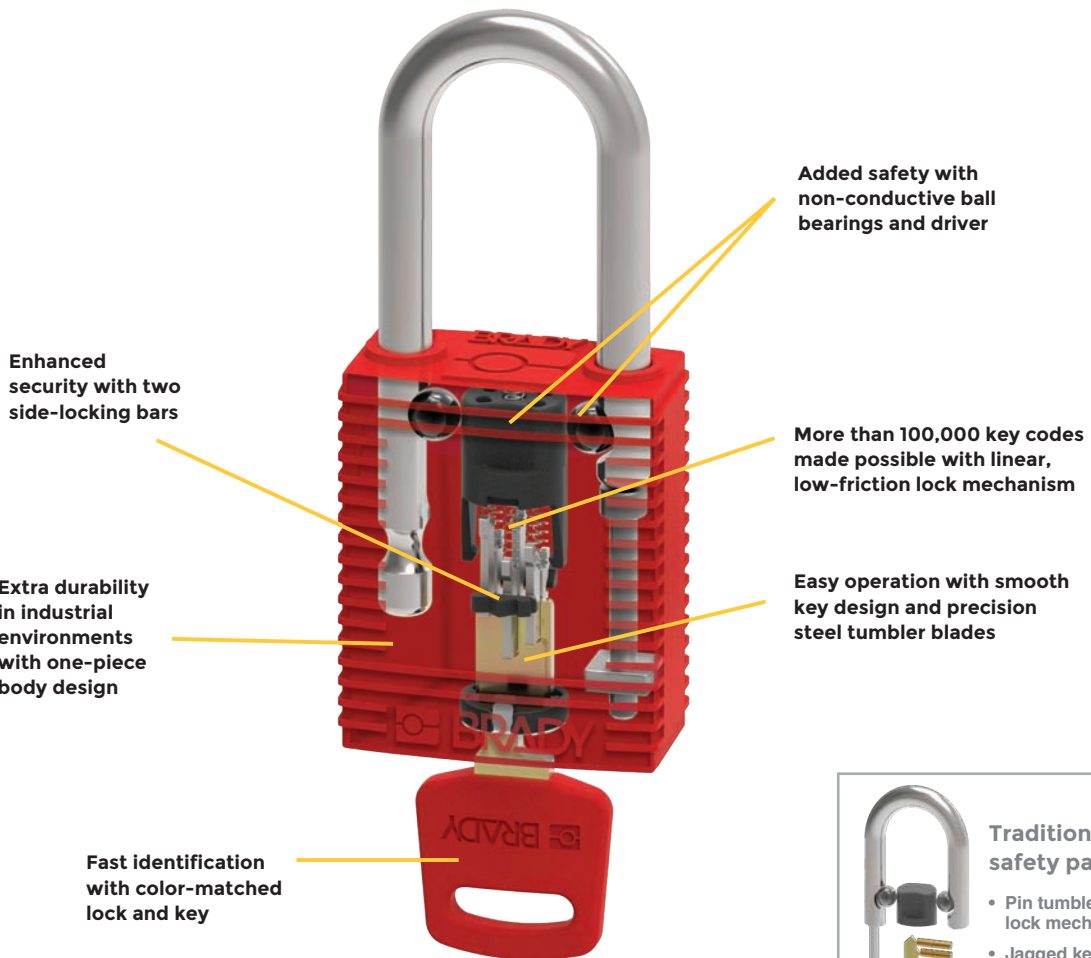

More really means more with SafeKey

In your lockout scenario, here's what you get with up to 700% more unique key codes:

	Other Nylon Padlocks	SafeKey Lockout Padlocks	
Keyed Different	15,000 Key Codes	100,000+ Key Codes	
1 Master Key	3,250 Key Codes	15,000+ Key Codes	
25 Master Keys	150 Key Codes	600+ Key Codes	

Lockout Tagout

Keying options for SafeKey and traditional lockout padlocks

Standard options



Keyed Different (KD)

Each lock is opened by its own unique key. Perfect for simple lockout applications and a manageable number of energy isolation points.

Keyed Alike (KA)

Each lock in the group can be opened with the same key, reducing the number of keys needed. Ideal for employees who work on multiple machines or isolation points.

Custom options

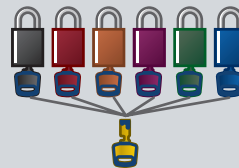

Master Keyed (MK)

Each grouping of locks (whether keyed alike or different) can be opened with a master key. Useful for larger, complex systems when supervisory access may be required.

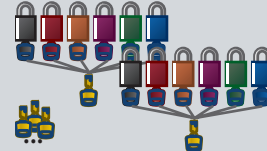

Grand Master Keyed (GMK)

The grand master key can open all locks grouped into two or more master keyed systems. Useful when supervisory or managerial access to all locks is needed.

Key Charting

Brady will keep a record of and "chart" all key numbers to ensure there's no unwanted key duplication on current or future orders, depending on your unique requirements.

Lockout Padlocks

BradyID.com/s36

new Brady SafeKey Lockout Padlocks

SafeKey Nylon Lockout Padlocks

- Key retaining feature within a lightweight nylon body is ideal for electrical and general lockout applications
- Two shackle options available; durable, steel shackle or polymer plastic shackle that is non-conductive and non-sparking
- Each padlock includes one key and lock labels in English, Spanish and French; additional keys can be ordered if needed
- Body: 1.8 in. H x 1.5 in. W x 0.75 in. D; shackle diameter: 0.25 in.

SafeKey Nylon Lockout Padlocks with 1.5 in. (38 mm) steel shackle

Color	Keyed Different 1/Pack	Keyed Different 6/Pack	Keyed Alike 3/Pack	Keyed Alike 6/Pack
Red	NYL-RED-38ST-KD	NYL-RED-38ST-KD6PK	NYL-RED-38ST-KA3PK	NYL-RED-38ST-KA6PK
Green	NYL-GRN-38ST-KD	NYL-GRN-38ST-KD6PK	NYL-GRN-38ST-KA3PK	NYL-GRN-38ST-KA6PK
Orange	NYL-ORG-38ST-KD	NYL-ORG-38ST-KD6PK	NYL-ORG-38ST-KA3PK	NYL-ORG-38ST-KA6PK
Blue	NYL-BLU-38ST-KD	NYL-BLU-38ST-KD6PK	NYL-BLU-38ST-KA3PK	NYL-BLU-38ST-KA6PK
Yellow	NYL-YLW-38ST-KD	NYL-YLW-38ST-KD6PK	NYL-YLW-38ST-KA3PK	NYL-YLW-38ST-KA6PK
Brown	NYL-BRN-38ST-KD	NYL-BRN-38ST-KD6PK	NYL-BRN-38ST-KA3PK	NYL-BRN-38ST-KA6PK
White	NYL-WHT-38ST-KD	NYL-WHT-38ST-KD6PK	NYL-WHT-38ST-KA3PK	NYL-WHT-38ST-KA6PK
Purple	NYL-PRP-38ST-KD	NYL-PRP-38ST-KD6PK	NYL-PRP-38ST-KA3PK	NYL-PRP-38ST-KA6PK
Black	NYL-BLK-38ST-KD	NYL-BLK-38ST-KD6PK	NYL-BLK-38ST-KA3PK	NYL-BLK-38ST-KA6PK



SafeKey Nylon Lockout Padlocks with 1.5 in. (38 mm) plastic shackle

Color	Keyed Different 1/Pack	Keyed Different 6/Pack	Keyed Alike 3/Pack	Keyed Alike 6/Pack
Red	NYL-RED-38PL-KD	NYL-RED-38PL-KD6PK	NYL-RED-38PL-KA3PK	NYL-RED-38PL-KA6PK
Green	NYL-GRN-38PL-KD	NYL-GRN-38PL-KD6PK	NYL-GRN-38PL-KA3PK	NYL-GRN-38PL-KA6PK
Orange	NYL-ORG-38PL-KD	NYL-ORG-38PL-KD6PK	NYL-ORG-38PL-KA3PK	NYL-ORG-38PL-KA6PK
Blue	NYL-BLU-38PL-KD	NYL-BLU-38PL-KD6PK	NYL-BLU-38PL-KA3PK	NYL-BLU-38PL-KA6PK
Yellow	NYL-YLW-38PL-KD	NYL-YLW-38PL-KD6PK	NYL-YLW-38PL-KA3PK	NYL-YLW-38PL-KA6PK
Brown	NYL-BRN-38PL-KD	NYL-BRN-38PL-KD6PK	NYL-BRN-38PL-KA3PK	NYL-BRN-38PL-KA6PK
White	NYL-WHT-38PL-KD	NYL-WHT-38PL-KD6PK	NYL-WHT-38PL-KA3PK	NYL-WHT-38PL-KA6PK
Purple	NYL-PRP-38PL-KD	NYL-PRP-38PL-KD6PK	NYL-PRP-38PL-KA3PK	NYL-PRP-38PL-KA6PK
Black	NYL-BLK-38PL-KD	NYL-BLK-38PL-KD6PK	NYL-BLK-38PL-KA3PK	NYL-BLK-38PL-KA6PK



SafeKey Nylon Lockout Padlocks with 3.0 in. (76 mm) steel shackle

Color	Keyed Different 1/Pack
Red	NYL-RED-76ST-KD
Green	NYL-GRN-76ST-KD
Orange	NYL-ORG-76ST-KD
Blue	NYL-BLU-76ST-KD
Yellow	NYL-YLW-76ST-KD
Brown	NYL-BRN-76ST-KD
White	NYL-WHT-76ST-KD
Purple	NYL-PRP-76ST-KD
Black	NYL-BLK-76ST-KD



Lockout Tagout

Engraving

SafeKey padlocks can be laser-engraved on one to four surfaces to identify individuals, departments, work areas, serial numbers and company logos. Additionally, SafeKey keys can be engraved with up to 10 characters.

Design-Your-Own Padlock Online

Create a custom SafeKey padlock with exactly the options you need, including engraving, in one easy-to-use online tool. Try it today at BradyID.com/CustomPadlocks



SafeKey Padlock Labels

- Labels help send a clear message when machine is down for service or maintenance
- Keep track of your Brady SafeKey Lockout Padlocks by writing who owns that padlock on the label

Catalog #	Description	Size	Qty.
150556	English, French, Spanish	Compact 0.89 in x 1 in	6 cards
150555	English, French, Spanish	Standard 1.12 in x 1 in	6 cards
65508	Lock Label Overlaminates	1 in. x 6 in.	40

new Brady SafeKey Lockout Padlocks

SafeKey Compact Nylon Lockout Padlocks

- Ideal for use in small spaces in electrical and maintenance applications
- Extremely compact and lightweight design with non-conductive and non-sparking nylon body and polymer shackle
- Each padlock includes one key and lock labels in English, Spanish and French; additional keys can be ordered if needed
- Body: 1.7 in. H x 1.25 in. W x 0.75 in. D; shackle diameter: 0.17 in.

SafeKey Compact Nylon Padlocks with 1.0 in. (25 mm) plastic shackle

Color	Keyed Different 1/Pack	Keyed Different 6/Pack	Keyed Alike 3/Pack	Keyed Alike 6/Pack
Red	CPT-RED-25PL-KD	CPT-RED-25PL-KD6PK	CPT-RED-25PL-KA3PK	CPT-RED-25PL-KA6PK
Green	CPT-GRN-25PL-KD	CPT-GRN-25PL-KD6PK	CPT-GRN-25PL-KA3PK	CPT-GRN-25PL-KA6PK
Orange	CPT-ORG-25PL-KD	CPT-ORG-25PL-KD6PK	CPT-ORG-25PL-KA3PK	CPT-ORG-25PL-KA6PK
Blue	CPT-BLU-25PL-KD	CPT-BLU-25PL-KD6PK	CPT-BLU-25PL-KA3PK	CPT-BLU-25PL-KA6PK
Yellow	CPT-YLW-25PL-KD	CPT-YLW-25PL-KD6PK	CPT-YLW-25PL-KA3PK	CPT-YLW-25PL-KA6PK
Brown	CPT-BRN-25PL-KD	CPT-BRN-25PL-KD6PK	CPT-BRN-25PL-KA3PK	CPT-BRN-25PL-KA6PK
White	CPT-WHT-25PL-KD	CPT-WHT-25PL-KD6PK	CPT-WHT-25PL-KA3PK	CPT-WHT-25PL-KA6PK
Purple	CPT-PRP-25PL-KD	CPT-PRP-25PL-KD6PK	CPT-PRP-25PL-KA3PK	CPT-PRP-25PL-KA6PK
Black	CPT-BLK-25PL-KD	CPT-BLK-25PL-KD6PK	CPT-BLK-25PL-KA3PK	CPT-BLK-25PL-KA6PK



SafeKey Compact Nylon Padlock Kits

Ideal for those needing just one lock and one tag. Kit includes:

- 1 - SafeKey Compact Nylon Padlock
- 1 - Heavy-duty Polyester Tag
- 1 - Nylon Cable Tie

Color	Catalog #	Description
Red	150938	SafeKey Compact Nylon Padlock Kit



SafeKey Aluminum Lockout Padlocks

- Ideal for indoor and outdoor use and heavy-duty applications
- Aluminum padlock with steel shackle provides corrosion resistance
- Each padlock includes one key and lock labels in English, Spanish and French; additional keys can be ordered if needed
- Body: 1.8 in. H x 1.5 in. W x 0.75 in. D; shackle diameter: 0.25 in.

SafeKey Aluminum Lockout Padlocks with 1.5 in. (38 mm) steel shackle

Color	Keyed Different 1/Pack	Keyed Different 6/Pack	Keyed Alike 3/Pack	Keyed Alike 6/Pack
Red	ALU-RED-38ST-KD	ALU-RED-38ST-KD6PK	ALU-RED-38ST-KA3PK	ALU-RED-38ST-KA6PK
Green	ALU-GRN-38ST-KD	ALU-GRN-38ST-KD6PK	ALU-GRN-38ST-KA3PK	ALU-GRN-38ST-KA6PK
Orange	ALU-ORG-38ST-KD	ALU-ORG-38ST-KD6PK	ALU-ORG-38ST-KA3PK	ALU-ORG-38ST-KA6PK
Blue	ALU-BLU-38ST-KD	ALU-BLU-38ST-KD6PK	ALU-BLU-38ST-KA3PK	ALU-BLU-38ST-KA6PK
Yellow	ALU-YLW-38ST-KD	ALU-YLW-38ST-KD6PK	ALU-YLW-38ST-KA3PK	ALU-YLW-38ST-KA6PK
Brown	ALU-BRN-38ST-KD	ALU-BRN-38ST-KD6PK	ALU-BRN-38ST-KA3PK	ALU-BRN-38ST-KA6PK
Silver	ALU-SLV-38ST-KD	ALU-SLV-38ST-KD6PK	ALU-SLV-38ST-KA3PK	ALU-SLV-38ST-KA6PK
Purple	ALU-PRP-38ST-KD	ALU-PRP-38ST-KD6PK	ALU-PRP-38ST-KA3PK	ALU-PRP-38ST-KA6PK
Black	ALU-BLK-38ST-KD	ALU-BLK-38ST-KD6PK	ALU-BLK-38ST-KA3PK	ALU-BLK-38ST-KA6PK

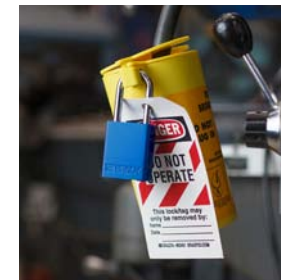

SafeKey Aluminum Lockout Padlocks with 3.0 in. (76 mm) steel shackle

Color	Keyed Different 1/Pack	Keyed Different 6/Pack	Keyed Alike 3/Pack	Keyed Alike 6/Pack
Red	ALU-RED-76ST-KD	ALU-RED-76ST-KD6PK	ALU-RED-76ST-KA3PK	ALU-RED-76ST-KA6PK
Green	ALU-GRN-76ST-KD	ALU-GRN-76ST-KD6PK	ALU-GRN-76ST-KA3PK	ALU-GRN-76ST-KA6PK
Orange	ALU-ORG-76ST-KD	ALU-ORG-76ST-KD6PK	ALU-ORG-76ST-KA3PK	ALU-ORG-76ST-KA6PK
Blue	ALU-BLU-76ST-KD	ALU-BLU-76ST-KD6PK	ALU-BLU-76ST-KA3PK	ALU-BLU-76ST-KA6PK
Yellow	ALU-YLW-76ST-KD	ALU-YLW-76ST-KD6PK	ALU-YLW-76ST-KA3PK	ALU-YLW-76ST-KA6PK
Brown	ALU-BRN-76ST-KD	ALU-BRN-76ST-KD6PK	ALU-BRN-76ST-KA3PK	ALU-BRN-76ST-KA6PK
Silver	ALU-SLV-76ST-KD	ALU-SLV-76ST-KD6PK	ALU-SLV-76ST-KA3PK	ALU-SLV-76ST-KA6PK
Purple	ALU-PRP-76ST-KD	ALU-PRP-76ST-KD6PK	ALU-PRP-76ST-KA3PK	ALU-PRP-76ST-KA6PK
Black	ALU-BLK-76ST-KD	ALU-BLK-76ST-KD6PK	ALU-BLK-76ST-KA3PK	ALU-BLK-76ST-KA6PK



Lockout Tagout

Lockout Padlocks

BradyID.com/s36



Actual size of
Brady's
Compact Nylon
Lockout Padlock

Nylon Lockout Padlocks

- Complies with all OSHA requirements and are a safer alternative to metal locks
- Non-conductive body with unique key cylinder prevents electricity from traveling from the shackle to the key, protecting workers when key is inserted
- Superior temperature, chemical and corrosion resistance
- Labels provided in English, Spanish, French
- Key-retaining feature prevents key from being removed until shackle is securely closed
- Reserved paracentric keyway provides optimal security (prevents a copy from being made at a local key shop)
- Locks come keyed differently or keyed alike. Custom keying and charting available
- Lock bodies can be custom laser engraved upon request
- One key is supplied with each padlock for safer key management

Lockout Tagout



Compact Nylon Lockout Padlocks

- Extremely compact and lightweight
- Easily fits in small spaces making it ideal for electrical contractors, maintenance and electricians
- 5-pin cylinder can support same keying system as our current Nylon Lockout Padlock
- Fiberglass reinforced nylon body for extra impact resistance
- Service temperature: 0° to 250° F (-20° to 120° C)
- Lock body dimensions: 1.4 in. x 1.2 in. x 0.625 in. Shackle clearance: 1 in.; shackle diameter 0.2 in.
- Each padlock includes 1 key and 1 each English, Spanish and French labels

Compact Nylon Lockout Padlocks with 1 in. steel shackle

Color	Keyed Different 1/Pack	Keyed Different 6/Pack	Keyed Alike 3/Pack	Keyed Alike 6/Pack
Red	143150	118926	118953	118954
Green	143152	118927	118955	118956
Orange	143154	118928	118957	118958
Blue	143156	118929	118959	118960
Yellow	143158	118930	118961	118962
Brown	143160	118931	118963	118964
White	143162	118932	118965	118966
Purple	143164	118933	118967	118968
Black	143166	118934	118969	118970



Nylon Lockout Padlocks

- Lightweight, non-conductive and non-sparking body
- Special 6-pin cylinder resists tampering
- Fiberglass reinforced nylon body and triple-coated hardened steel shackle
- Service temperature: 0° to 250° F (-20° to 120° C)
- Lock body dimensions: 1.75 in. x 1.25 in. x 0.8 in.
- Shackle clearance: 1.25 in.; shackle diameter: 0.25 in.
- Each padlock includes 1 key and 1 each English, Spanish and French labels

Nylon Lockout Padlocks with 1.25 in. steel shackle

Color	Keyed Different 1/Pack	Keyed Different 6/Pack	Keyed Alike 3/Pack	Keyed Alike 6/Pack
Red	99552	51339	105886	105890
Green	99564	51345	105889	105893
Orange	99576	51347	123268	123270
Blue	99556	51344	105887	105891
Yellow	99570	51346	105888	105892
Brown	103033	101956	118947	118948
White	143123	118925	118949	118950
Purple	104919	104916	118951	118952
Black	99580	51353	123269	123271

When keyed alike, all locks in a set can be opened with the same key. This option is beneficial when multiple locks are assigned to a single employee.



Compact Nylon Padlock Kits

Ideal for any worker needing just one lock and one tag.

- 1 - Compact Padlock
- 1 - Heavy-duty Polyester Tag
- 1 - Nylon Cable Tie

Color	Description	Catalog #
Red	Compact Nylon Padlock Kit	123143



Compact Cable Padlocks

- Compact 1.31 in. x 1.25 in. nylon body with an elongated, flexible cable as the shackle
- Flexible cable means you can angle and twist padlock or lockout multiple energy isolation points with one lock

Compact Cable Padlocks

Color	Cable Length	Keyed Different 1/Pack	Keyed Alike 6/Pack
Red	7.87 in. cable	146120	146128
Red	15.75 in. cable	146124	146132
Yellow	7.87 in. cable	146121	146129
Yellow	15.75 in. cable	146125	146133
Blue	7.87 in. cable	146122	146130
Blue	15.75 in. cable	146126	146134
Green	7.87 in. cable	146123	146131
Green	15.75 in. cable	146127	146135



Nylon Lockout Padlocks with Non-Conductive Nylon Shackle

- Lightweight, non-conductive and non-sparking body
- Special 6-pin cylinder resists tampering
- Fiberglass reinforced nylon body with non-conductive nylon shackle
- Lock body dimensions: 1.75 in. x 1.25 in. x 0.8 in.
- Shackle clearance: 1.25 in.; shackle diameter: 0.25 in.
- Each padlock includes 1 key and 1 each English, Spanish and French labels



Long Body Nylon Lockout Padlocks

- 3 in. long body has ample space for your most important identification information
- Lightweight, non-conductive and non-sparking body
- Special 6-pin cylinder resists tampering
- Fiberglass reinforced nylon body and triple-coated hardened steel shackle
- Service temperature: 0° to 250° F (-20° to 120° C)
- Lock body dimensions: 3 in. x 1.25 in. x 0.8 in.
- Shackle clearance: 1.25 in.; shackle diameter: 0.25 in.
- Each padlock includes 1 key and 1 each English/Spanish and English/French labels

Nylon Lockout Padlocks with 1.25 in. nylon shackle

Color	Keyed Different 1/Pack	Keyed Different 6/Pack	Keyed Alike 3/Pack	Keyed Alike 6/Pack
Red	123324	123351	123333	123342
Green	123326	123353	123335	123344
Orange	123328	123355	123337	123346
Blue	123325	123352	123334	123343
Yellow	123327	123354	123336	123345
Brown	123330	123357	123339	123348
White	123332	123359	123341	123350
Purple	123331	123358	123340	123349
Black	123329	123356	123338	123347

Long Body Nylon Lockout Padlocks with 1.25 in. steel shackle

Color	Keyed Different 1/Pack	Keyed Different 6/Pack	Keyed Alike 3/Pack	Keyed Alike 6/Pack
Red	123405	123396	123414	123423
Green	123407	123398	123416	123425
Orange	123409	123400	123418	123427
Blue	123406	123397	123415	123424
Yellow	123408	123399	123417	123426
Brown	123411	123402	123420	123429
White	123413	123404	123422	123431
Purple	123412	123403	123421	123430
Black	123410	123401	123419	123428

When keyed alike, all locks in a set can be opened with the same key. This option is beneficial when multiple locks are assigned to a single employee.

Lockout Padlocks

BradyID.com/s36



Key-Retaining Laminated Steel Lockout Padlocks

- Key-retaining safety feature prevents key from being removed until shackle is closed
- Reinforced laminated steel withstands severe physical abuse while hardened steel shackle resists tampering, cutting, prying and rusting
- Body plates individually coated for superior rust protection
- 5-pin cylinder offers more unique key cuts, better tamper resistance than conventional 4-pin locks
- Colored bumpers supplied for identification (custom stamping available)
- Made from recycled material
- Each padlock includes 1 key. Custom keying and charting also available. Lock labels sold separately.
- Shackle clearance: 0.75 in., 2 in. or 3 in. Shackle diameter: 0.27 in. Lock body: 1.2 in. x 1.313 in. x 1 in.



Key-Retaining Steel Lockout Padlocks with 0.75 in. shackle

Color	Keyed Different 1/Pack	Keyed Different 6/Pack
Red	143126	118935
Green	143128	118936
Blue	143130	118937
Yellow	143132	118938
White	143134	118939
Black	143136	118940
Brown	123272	123280
Purple	123273	123281



Key-Retaining Steel Lockout Padlocks with 2 in. shackle

Color	Keyed Different 1/Pack	Keyed Different 6/Pack	Keyed Alike 3/Pack	Keyed Alike 6/Pack
Red	143144	118944	118977	118978
Green	143142	118943	118975	118976
Blue	143140	118942	118973	118974
Yellow	143148	118946	118981	118982
White	143146	118945	118979	118980
Black	143138	118941	118971	118972
Brown	123274	123282	123276	123278
Purple	123275	123283	123277	123279



Key-Retaining Steel Lockout Padlocks with 3 in. shackle

Color	Keyed Different 1/Pack	Keyed Different 6/Pack	Keyed Alike 3/Pack	Keyed Alike 6/Pack
Red	123244	123236	123252	123260
Green	123245	123237	123253	123261
Blue	123246	123238	123254	123262
Yellow	123247	123239	123255	123263
White	123248	123240	123256	123264
Black	123249	123241	123257	123265
Brown	123250	123242	123258	123266
Purple	123251	123243	123259	123267

When keyed alike, all locks in a set can be opened with the same key. This option is beneficial when multiple locks are assigned to a single employee.

Lockout Tagout



Laminated Steel Lockout Padlocks

- Reinforced laminated steel withstands severe physical abuse while hardened steel shackle resists tampering
- Body plates individually coated for superior rust protection
- 5-pin cylinder offers more unique key cuts, better tamper resistance than conventional 4-pin locks
- Colored bumpers supplied for identification
- Each padlock includes 1 key. Custom keying and charting also available. Lock labels sold separately
- Shackle clearance: 0.75 in. or 2 in. Shackle diameter: 0.27 in. Lock body: 1.33 in. x 1.188 in. x 0.875 in.



Steel Lockout Padlocks with 0.75 in. shackle

Color	Keyed Different 1/Pack	Keyed Different 6/Pack
Red	99500	51279
Blue	99504	51280
Green	99508	51281
Yellow	99512	51282
Orange	99516	51283
Black	99520	51284
Brown	101957	102696
Purple	104920	104917



Steel Lockout Padlocks with 2 in. shackle

Color	Keyed Different 1/Pack	Keyed Different 6/Pack	Keyed Alike 3/Pack	Keyed Alike 6/Pack
Red	99524	51290	105894	105898
Blue	99528	51291	105895	105899
Green	99533	51292	105897	105901
Yellow	99539	51297	105896	105900
Orange	99543	51298	-	-
Black	99548	51299	-	-
Brown	101958	102698	-	-
Purple	104921	104918	-	-

When keyed alike, all locks in a set can be opened with the same key. This option is beneficial when multiple locks are assigned to a single employee.



Aluminum Lockout Padlocks

- Lightest-weight aluminum lock in the market and made from recycled material
- Aluminum shackle has superior spark and corrosion resistance
- Reserved paracentric keyway provides optimal security (prevents someone from getting a copy made at a local key shop)
- Anodized aluminum finish gives better fade resistance when used outdoors
- FDA approved lubricant in cylinder
- Shackle clearance: 1 in., 1.25 in. or 3 in. Shackle diameter: 0.25 in.
- Compact body: 1.25 in. x 1.25 in. Regular body: 1.6 in. x 1.25 in. x 0.75 in.
- Compact body has a 5-pin cylinder. Regular body has 6-pin cylinder for more unique key changes and tamper resistance
- Each padlock includes 2 keys. Custom keying and charting also available. Lock labels sold separately



May we also suggest:



Custom Keying Solutions

At Brady, we can help you with your custom keying program. Just call Brady customer service to get started!



Combination Lock

Compact lock with a steel shackle and a 4-digit re-settable code

Catalog #	Description
101963	Combination Lock

Compact Aluminum with 1 in. shackle

Color	Keyed Different 1/Pack	Keyed Different 6/Pack	Keyed Alike 3/Pack	Keyed Alike 6/Pack
Red	133270	133261	133279	133288
Blue	133271	133262	133280	133289
Green	133272	133263	133281	133290
Yellow	133273	133264	133282	133291
Orange	133274	133265	133283	133292
Black	133275	133266	133284	133293
Brown	133276	133267	133285	133294
Purple	133277	133268	133286	133295
Silver	133278	133269	133287	133296

When keyed alike, all locks in a set can be opened with the same key. This option is beneficial when multiple locks are assigned to a single employee.



Aluminum Padlocks with 1 in. shackle

Color	Keyed Different 1/Pack	Keyed Different 6/Pack
Red	99608	51360
Blue	99609	51361
Green	99610	51362
Yellow	99611	51363
Orange	99612	51368
Black	99613	51369
Brown	104574	104575
Purple	104572	104573
Silver	123320	123322



Aluminum Padlocks with 1.25 in. shackle

Color	Keyed Different 1/Pack	Keyed Different 6/Pack	Keyed Alike 3/Pack	Keyed Alike 6/Pack
Red	99615	51370	105902	105882
Blue	99616	51371	105903	105883
Green	99617	51376	105881	105885
Yellow	99618	51377	105904	105884
Orange	99619	51378	123432	123437
Black	99620	50274	123433	123438
Brown	104578	104579	123434	123439
Purple	104576	104577	123435	123440
Silver	123321	123323	123436	123441

When keyed alike, all locks in a set can be opened with the same key. This option is beneficial when multiple locks are assigned to a single employee.

Aluminum Padlocks with 3 in. shackle

Color	Keyed Different 1/Pack	Keyed Different 6/Pack	Keyed Alike 3/Pack	Keyed Alike 6/Pack
Red	123293	123284	123302	123311
Blue	123294	123285	123303	123312
Green	123295	123286	123304	123313
Yellow	123296	123287	123305	123314
Orange	123297	123288	123306	123315
Black	123298	123289	123307	123316
Brown	123299	123290	123308	123317
Purple	123300	123291	123309	123318
Silver	123301	123292	123310	123319

Padlock Labels

BradyID.com/s36

Padlock Labels

Padlock labels are a great way to quickly identify padlocks. They help send a clear message to workers when a machine is down for service or maintenance.



Labels for Steel Padlocks

- Durable vinyl labels include overlaminates strips
- Labels accept pencil, pen or marker
- Designed to fit Steel Padlocks

Catalog #	Description	Size	Qty.
50280	English	0.75 in. x 4.5 in.	6
50281	Spanish	0.75 in. x 4.5 in.	6
50283	French	0.75 in. x 4.5 in.	6

Lockout Tagout



Labels for Steel Padlocks

- Durable vinyl labels accept pencil, pen or marker
- Designed to fit Steel Padlocks

Catalog #	Size	Qty.
121448	0.75 in. x 5 in.	40



Self-Laminating Labels for Steel Padlocks

- Durable vinyl labels accept pencil, pen or marker
- Designed to fit Steel Padlocks

Catalog #	Size	Qty.
121449	0.625 in. x 4 in.	5



Wrap-Around Lockout Labels for Steel Padlocks

- Labels accept pencil, pen or marker
- Designed to fit Steel Padlocks

Catalog #	Size	Qty.
LID-3	0.75 in. x 4.5 in.	25



Labels for Nylon Padlocks

- Durable vinyl labels accept pencil, pen or marker
- Designed to fit Nylon Lockout Padlocks
- Labels supplied with multiple languages

Catalog #	Description	Qty.
51379	English/Spanish/French	6 of each language



Labels for Aluminum Locks

- Durable vinyl labels accept pencil, pen or marker
- Designed to fit Aluminum Lockout Padlocks

Catalog #	Description	Size	Qty.
50289	English	0.8 in. x 1.1 in.	6
50292	Spanish	0.8 in. x 1.1 in.	6
50293	French	0.8 in. x 1.1 in.	6



Lock Label Overlaminates

- Clear overlaminates protect existing lock label from dirt and grease
- Lock label sold separately

Catalog #	Description	Qty.
65508	1 in. x 6 in. overlaminates	40



Steel Group Lockout Hasps

- Constructed of vinyl-coated high tensile steel w/ rust resistant plating
- Lock holes: 0.375 in. dia.

Catalog #	Description	Qty.
133161	1 in. diameter jaws	1
65375	1 in. diameter jaws	12
133162	1.5 in. diameter jaws	1
65376	1.5 in. diameter jaws	12



Steel Group Lockout Hasps with Tabs

- Tamperproof interlocking tabs prevent unauthorized opening
- Case-hardened steel with rust proof plating
- Lock holes: 0.375 in. dia.

Catalog #	Description	Qty.
105718	1 in. diameter jaws	1
105719	1.5 in. diameter jaws	1



Corrosion-Resistant Group Lockout Hasps

- 12 gauge epoxy coated steel provides superior rust resistance and added dielectric strength
- Lock holes: 0.313 in. dia.

Catalog #	Description	Qty.
T218	1 in. diameter jaws	1
T220	1.25 in. diameter	1



Aluminum Economy Group Lockout Hasps

- Non-sparking, aluminum small hasps are a great addition to your tool box
- Lightweight: Only 1.25 oz
- Lock holes: 0.375 in.

Catalog #	Description	Qty.
105720	1 in. diameter jaws	1
105721	1.5 in. diameter jaws	1



Non-Conductive Group Lockout Hasps

- Strong, rigid plastic resin
- Excellent electrical insulating
- Performs at low temps, excellent heat resistance

Catalog #	Description	Qty.
LH220A-RD	Lockout hasp	1



Heavy-Duty Lockout Hasp

- Hasp allows multiple workers to lockout at each isolation point
- Stainless steel construction
- Accommodates 0.33 in. dia. padlock shackles

Catalog #	Description	Qty.
871239	Heavy-Duty Hasp	24



Dual Jaw Hasp

- Dual construction allows for increased versatility in a single product
- Larger jaw measures 1.25 in. x 1.75 in.
- Smaller jaw measures 0.75 in. dia.

Catalog #	Description	Qty.
236919	Dual Jaw Hasp	1



Non-Conductive Nylon Group Lockout Hasp

- Accommodate up to 6 locks
- Withstands up to 1,000 lbs despite weighing only 1 oz.
- Dimensions: 7 in. x 1.75 in. Lock holes: 0.375 in. dia.

Catalog #	Description	Qty.
99668	Nylon Lockout Hasp	1

Lockout Tagout



Labeled Group Lockout Hasps

- Tough 5052 anodized aluminum alloy hasps include tamperproof locking tabs
- Write-on label accepts pencil, pen or marker. Pen and pencil markings are easily erased for repeated use
- Size: 7 in. x 3 in. x 0.187 in. Lock holes: 0.313 in. dia.



Legend option 1

Catalog #	Color	Qty.
65960	Red	5
65961	Silver	5
65962	Blue	5
65963	Green	5
65964	Gold	5
65967	Combo*	5



Legend option 2

Catalog #	Color	Qty.
65970	Red	5
65971	Silver	5
65972	Blue	5
65973	Green	5
65974	Gold	5
65975	Combo*	5

*Combo includes 1 each of the five colors listed above.



Legend option 3

Catalog #	Color	Qty.
39480	Red	5



Legend option 4

Catalog #	Color	Qty.
39481	Red	5

Group Lock Boxes

BradyID.com/s36

Group Lock Boxes

For group lockout situations involving a large number of workers and equipment, lock boxes can offer a number of advantages including fewer padlocks and hasps needed.

How group lockout boxes work:

- Supervisor uses a single job lock on each energy control point to lock out equipment. Keys for that lock are placed in the lock box
- Each worker applies his own lock to the lock box. As long as any one worker's lock remains on the lockout box, the keys to the job locks cannot be accessed, and the energy isolating devices cannot be operated. Each employee retains exclusive control, as required by OSHA.



new



SlimView™ Group Lock Box

- Innovative narrow design and recessed door allow padlocks to hang straight, reducing the overall footprint by 60% compared to traditional lock boxes
- Steel body and clear polycarbonate door to see contents
- Built-in padlock and key hangers
- Storage for up to 12 padlocks
- Wall mountable
- Size: 10.125 in. x 4.0 in.

Catalog #	Description
150505	SlimView Lock Box

Padlocks sold separately.

Lockout Tagout



Ultra-Compact Lock Box

- Compact size for portability in your lockout kit or toolbox
- Simple storage with wall-mount bracket when not in use
- Hinged transparent cover for easy viewing of contents
- Can accommodate up to 12 locks
- Size: 5.25 in. x 3.25 in. x 2.25 in.

Catalog #	Description
149173	Box without locks
149172	Box with 6 Yellow Keyed-Alike Locks
149176	Box with 6 Yellow Keyed-Different Locks
149174	Box with 6 Red Keyed-Alike Locks
149175	Box with 6 Red Keyed-Different Locks



Portable Metal Group Lockout Boxes

- Made of heavy-duty steel, powder-coated for extra rust resistance
- Features lockable clasp and 12 holes along lid
- Standard: 6 in. x 9 in. x 3.25 in.
Compartment holds up to 40 padlocks
- Extra large: 6 in. x 7.375 in. x 9.25 in.
Compartment holds up to 75 padlocks

Catalog #	Description	Size	Color
45190	Standard-English	6 in. x 9 in. x 3.25 in.	Blue
65699	Standard-English	6 in. x 9 in. x 3.25 in.	Red
65040	Standard-Spanish	6 in. x 9 in. x 3.25 in.	Red
51171	XLarge-English	6 in. x 7.375 in. x 9.25 in.	Red

Padlocks sold separately.



Portable Metal Group Lockout Boxes

- Made of heavy-duty steel, powder-coated for extra rust resistance
- Standard: 6 in. x 9 in. x 3.25 in.
- Compartment holds up to 40 padlocks

Lockable clasp only

Catalog #	Description	Size	Color
65672	Standard-English	6 in. x 9 in. x 3.25 in.	Yellow

Padlocks sold separately.



SAFETY REDBOX™ Group Lockout Box

- Use as a portable or a wall-mounted lockbox
- Quick release internal slide button allows lockbox to be carried to the point of need
- Can accommodate up to 12 padlocks
- Size: 6 in. x 9 in. x 3.25 in.

Catalog #	Description	Color
145579	Mountable Lockbox	Red
145580	Mountable Lockbox	Yellow

Padlocks sold separately.



Lock Storage / Group Lockout Box

- Heavy-duty steel, powder-coated for extra rust resistance
- Features a lockable storage compartment and a group lockout compartment
- Lockout compartment has clear window with keyhole slot
- Standard Box: 12.25 in. x 7.25 in. x 6 in.
Compartment: 8.25 in. x 6 in. x 6 in.
Compartment holds approx. 50 locks.
17 lock holes along box lid
- Large box: 15 in. x 10.25 in. x 9 in.
Compartment: 10.25 in. x 9 in. x 9 in.
Compartment holds approx. 125 locks
34 lock holes along box lid

Catalog #	Description	Size	Color
105716	Standard	12.25 in. x 7.25 in. x 6 in.	Red
105717	Large	15 in. x 10.25 in. x 9 in.	Red

Padlocks sold separately.

Group Lockout Boxes

BradyID.com/s36



Metal Wall-Mounted Group Lockout Boxes

- Made of durable, powder-coated steel with key slot on top
- Clear window slides out when locks are removed
- Comes with key pegs and ID labels
- Wall-mounting holes and hardware
- Small lock box: 7 in. x 8 in. x 2.25 in. 7 key pegs that hold 5 keys each, 7 lock holes along bottom
- Large lock box: 7 in. x 16 in. x 2.25 in. 15 key pegs that hold 5 keys each, 12 lock holes along bottom

Catalog #	Description
105714	Small Metal Lock Box
105715	Large Metal Lock Box

Padlocks sold separately.



Acrylic Wall-Mounted Group Lockout Boxes

- Made of acrylic plastic with transparent front cover
- Includes pre-drilled holes for easy wall mounting
- Pre-attached plastic hooks for hanging keys, tag stubs, etc.
- Small: 3 key hooks, max 6 locks
- Medium: 8 key hooks, max 10 locks
- Large: 18 key hooks, max 14 locks

Catalog #	Description	Size
LG003E	Small	6 in. x 6 in. x 2.5 in.
LG008E	Medium	7.5 in. x 12 in. x 2.5 in.
GLOBOX	Large	7.5 in. x 15.75 in. x 2.5 in.

Padlocks sold separately.



Wall-Mounted Group Lockout Box

- Injection molded for extra durability
- Excellent chemical and heat resistance
- Slot in front allows keys to be inserted when locked
- Includes pre-drilled holes for easy wall mounting
- 6 interior hooks for hanging keys/locks
- Lock rails hold up to 8 padlocks
- Dimensions: 6.2 in. x 4 in. x 5.25 in.

Catalog #	Description
50938	Miniature Wall Lock Box
50939	Extra Key Hooks (12/Pkg)

Padlocks sold separately.

Lockout Tagout



Portable / Wall-Mounted Plastic Group Lockout Box

- Durable plastic lockbox with transparent windows
- Excellent chemical and heat resistance
- Slot in front allows for keys to be inserted when box is locked
- Pre-drilled holes for wall mounting
- 12 interior hooks for keys or locks
- Lock rails hold up to 16 padlocks
- Size: 7.25 in. x 8.25 in. x 4.25 in.

Catalog #	Description
50937	Portable Plastic Lock Box
50939	Extra Key Hooks (12/pkg)

Padlocks sold separately.



Portable / Wall-Mounted Group Lockout Box

- Powder-coated steel lock box includes a removable handle for portability as well as holes for wall mounting
- Accommodates 8-10 locks
- Dimensions: 6 in. x 15 in. x 3 in.

Catalog #	Description
LG252M	Metal Wall Lock Box

Padlocks sold separately.

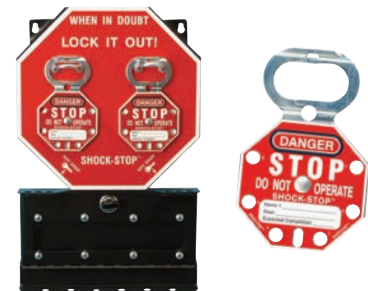

SHOCK-STOP™ Group Lockout Box

- Combines lock box with storage board for hasps
- Lock box accommodates up to 6 locks and provides rail for storing locks
- Includes two SHOCK-STOP™ hasps, mounting hardware and instructions
- Size: 16.25 in. x 10.25 in. x 2.25 in.

Catalog #	Description
87692	Group Lock Box (w/2 hasps)
87693	Hasp (5/pkg)

Padlocks sold separately.



Padlock and Tag Carrier

- Convenient transportation and storage of 12 locks, keys, tags and hasps all in one place
- Reduces the amount of lost or misplaced padlocks and hasps
- Offset design for flush wall mounting, equipment mounting or hanging on a belt clip
- Available with or without padlocks
- Carrier Components
 - 1 - Lock and Tag Carrier
 - 2 - Small Carabineers
 - 1 - Large Carabineer
 - 1 - Coiled Key Strap
 - 3 - Labels in English / French / Spanish
 - 3 - Write-on Lockout Procedure Tags
 - Optional: nylon padlocks and hasps

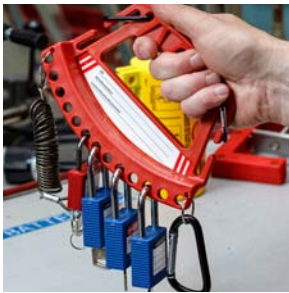

Catalog #		Color	Includes
148866	Padlock and Tag Carrier	Red Carrier	-
148865	Padlock and Tag Carrier	Yellow Carrier	-
148862	Padlock and Tag Carrier	Blue Carrier	-
148861	Padlock and Tag Carrier	Green Carrier	-
148864	Padlock and Tag Carrier Kit	Red Carrier	6 Red Keyed Alike 6 Yellow Keyed Alike 2 Hasps
148869	Padlock and Tag Carrier Kit	Red Carrier	3 Red Keyed Alike 3 Yellow Keyed Alike 3 Blue Keyed Alike 3 Green Keyed Alike 2 Hasps
148867	Padlock and Tag Carrier Kit	Red Carrier	12 Red Keyed Different 2 Hasps
148863	10 Write-On Lockout Procedure Tags		



Padlock Stations

- Constructed of 14 gauge steel with red plastic coating
- Small: 2.25 in. x 3 in. x 1.25 in., holds up to 4 padlocks
- Large: 3 in. x 16 in. x 1.25 in., holds up to 24 padlocks

Catalog #	Description
LR060E	Small Padlock Station
LR360E	Large Padlock Station

Padlocks sold separately.



Enclosed Padlock Storage Modules

- Constructed of sintra with lockable, transparent acrylic doors
- Provides safe storage and controls access to padlocks
- Small: 15 in. x 15 in. x 3.5 in., holds 16 locks
- Large: 30 in. x 15 in. x 3.5 in., holds 40 locks

Catalog #	Description
65240	Small Padlock Storage Module
65241	Large Padlock Storage Module

Padlocks sold separately.



Steel Lockout Padlock Control Centers

- Constructed of red powder-coated 22 gauge steel
- Each metal hook can hold 2 locks
- Two keys supplied for cabinet lock
- Small: 10 in. x 12 in. x 2 in., holds 16 locks
- Large: 15.5 in. x 18 in. x 2 in., holds 32 locks

Catalog #	Description
LR008E	Small Padlock Control Center
LR018E	Large Padlock Control Center

Padlocks sold separately.

Lockout Tagout

Lockout Tags

BradyID.com/s36

OSHA Lockout Tagout Regulations

The following requirements apply only to tags used as tagout devices (i.e., tags used alone without locks). Tags used in combination with locks are not required to meet the same restrictions as tagout devices.

Tagout devices must:

- Be provided by the employer
- Be standardized by size, shape or color
- Be distinguishable from tags used for other purposes
- Be understandable to all employees
- Identify the individual who applied the tag
- Withstand the usage environment to which they are exposed for the maximum period of time that exposure is intended. Tag should not deteriorate or the message become illegible when exposed to weather, wet or damp conditions, chemical or corrosive environments
- Employ a means of attachment that is substantial enough to prevent accidental removal. The means of attachment must be of a non-reusable type, attachable by hand, self-locking and non-releasable with a minimum unlocking strength of no less than 50 pounds
- Warn against hazardous conditions if the machine or equipment is energized
- Tag shall also include a legend such as the following: Do Not Operate, Do Not Start, Do Not Open, Do Not Close, etc.

Standard Lockout Tags

Communicate safety and lockout information at the point of need with the wide selection of OSHA-compliant lockout tagout tags from Brady. Tags come in a variety of materials and legends to suit your application needs.

How to order tags

1. Select from the materials below based on your application
2. Choose the tag legend for your tag
3. Order by part number for desired reverse side legend



Materials Options:



Heavy-Duty Polyester (B-837)

- Durable polyester laminate completely encapsulates and protects graphics
- Designed to withstand moisture, grease, chemicals and extreme temperatures
- Accepts pencil, pen and marker. Pen and marker can be completely erased using isopropyl alcohol
- Exceeds OSHA pull requirement withstanding up to 80 lbs. of pull force
- Tag size 5.75 in. x 3 in.
- 0.375 in. dia. heavy-duty brass grommet
- Includes OSHA-compliant nylon fasteners
- 2-year outdoor fade resistance



Economy Polyester (B-851)

- Rigid polyester surface is easy to write on and stays legible longer than cardstock
- Exceeds OSHA 50 lb. pull requirement for tagout devices
- Tag size 5.75 in. x 3 in.
- 0.375 in. dia. rolled brass eyelet accepts most padlock shackles
- Includes OSHA-compliant nylon fasteners
- Provides good outdoor UV resistance
- 3- to 5-year outdoor fade resistance



Cardstock (B-853)

- Cost-effective tags designed for one-time use
- Does NOT meet OSHA 50 lb. pull test for tagout devices, but can be used in conjunction with locks (see OSHA tag requirements above)
- Tag size 5.75 in. x 3 in.
- 0.375 in. dia. rolled brass eyelet accepts most padlock shackles
- Includes attachment strings

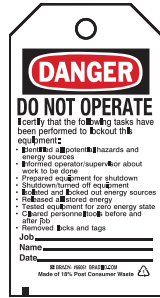

Catalog #	Reverse Legend	Qty.
Heavy-Duty Polyester		
65502	Side B	25
65535	Side F	25
65670	Side G	25
Economy Polyester		
66050	Side B	25
66051	Side F	25
66052	Side G	25
Cardstock		
65407	Side B	25
65408	Side F	25
65440	Side G	25

Catalog #	Reverse Legend	Qty.
Heavy-Duty Polyester		
65520	Side B	25
65525	Side F	25
65671	Side G	25
Economy Polyester		
66063	Side B	25
66064	Side F	25
66065	Side G	25
Cardstock		
65451	Side B	25
65452	Side F	25
65453	Side G	25

Catalog #	Reverse Legend	Qty.
Heavy-Duty Polyester		
65515	Side B	25
65524	Side F	25
133489	Side G	25
Economy Polyester		
66061	Side B	25
66062	Side F	25
133490	Side G	25
Cardstock		
133491	Side B	25
65450	Side F	25
133492	Side G	25

Catalog #	Reverse Legend	Qty.
Heavy-Duty Polyester		
65526	Side B	25
65527	Side F	25
133493	Side G	25
Economy Polyester		
66066	Side B	25
66067	Side F	25
133494	Side G	25
Cardstock		
65454	Side B	25
65455	Side F	25
133495	Side G	25

Catalog #	Reverse Legend	Qty.
Heavy-Duty Polyester		
65505	Side B	25
65523	Side F	25
133496	Side G	25
Economy Polyester		
133497	Side B	25
133498	Side F	25
133499	Side G	25
Cardstock		
65445	Side B	25
65446	Side F	25
133544	Side G	25



Catalog #	Reverse Legend	Qty.
Heavy-Duty Polyester		
65503	Side B	25
65521	Side F	25
133545	Side G	25
Economy Polyester		
66053	Side B	25
66054	Side F	25
133546	Side G	25
Cardstock		
65441	Side B	25
65442	Side F	25
133547	Side G	25

Catalog #	Reverse Legend	Qty.
Heavy-Duty Polyester		
65504	Side B	25
65522	Side F	25
133548	Side G	25
Economy Polyester		
66055	Side B	25
66056	Side F	25
133549	Side G	25
Cardstock		
65443	Side B	25
65444	Side F	25
133550	Side G	25

Catalog #	Reverse Legend	Qty.
Heavy-Duty Polyester		
133551	Side B	25
133552	Side F	25
133553	Side G	25
Economy Polyester		
50198	Side B	25
50199	Side F	25
133554	Side G	25
Cardstock		
133555	Side B	25
50250	Side F	25
133556	Side G	25

Catalog #	Reverse Legend	Qty.
Heavy-Duty Polyester		
65506	Side B	25
65534	Side F	25
133557	Side G	25
Economy Polyester		
133558	Side B	25
66060	Side F	25
133559	Side G	25
Cardstock		
65447	Side B	25
65448	Side F	25
133560	Side G	25

Catalog #	Reverse Legend	Qty.
Heavy-Duty Polyester		
133561	Side B	25
50258	Side F	25
133562	Side G	25
Economy Polyester		
133563	Side B	25
133564	Side F	25
133565	Side G	25
Cardstock		
50261	Side B	25
133566	Side F	25
133567	Side G	25

Lockout Tagout

Can't find what you're looking for?

Call your Brady Representative to find out more about custom solutions.

Reverse Legend Options

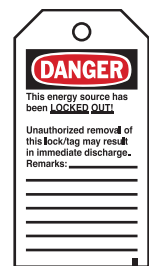

Reverse Side B

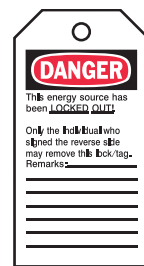

Reverse Side F



Reverse Side G

Lockout Tags

BradyID.com/s36

new



RipTag™ Safety Tag Rolls

- Complete and convenient take-it-with-you system for tagging
- Includes a bulk roll of tags that easily tear off and cable ties for quick attachment
- B-851 polyester tags comply with OSHA's 50 lb. pull force regulation for lockout tagout



150502 5.75 in x 3 in 250/roll
150501 5.75 in x 3 in 100/roll



150504 5.75 in x 3 in 250/roll
150503 5.75 in x 3 in 100/roll

Lockout Tagout



ToughWash® Metal-Detectable Tags

- ToughWash B-869 polypropylene tags feature in-molded, protected graphics for use in harsh washdown environments
- With metal and X-ray detectable properties, these tags won't compromise your food safety
- Durable plastic-encapsulated material withstands harsh washdown environments with temperatures up to 175° F (80° C) and pressure up to 1500 PSI
- Includes 10 metal-detectable cable ties



145766 5 in. x 3 in. 10 pk



145767 5 in. x 3 in. 10 pk



145768 5 in. x 3 in. 10 pk



145769 5 in. x 3 in. 10 pk



Extra Metal Detectable Ties

145588 7" ToughWash Ties 10 pk
145589 7" ToughWash Ties 100 pk



Spanish Lockout Tags

- **B-837 Heavy-Duty Laminated Polyester Tags** meet OSHA's 50 lb. pull force requirement and have superior chemical resistance and 2 year outdoor fade resistance. Nylon ties included.
- **B-851 Economy Polyester Tags** meet OSHA's 50 lb. pull force requirement, have moderate chemical resistance and 3-5 year outdoor fade resistance. Nylon ties included.
- **B-853 Cardstock Tags** are a economical, yet durable material option. Attachment strings included.



98219 5.75 in. x 3 in. B-837 25/pk



121514 5.75 in. x 3 in. B-851 25/pk

Includes self-laminate flap to protect face of tag and photo.



121515 5.75 in. x 3 in. B-837 25/pk

121516 5.75 in. x 3 in. B-851 25/pk

121517 5.75 in. x 3 in. B-853 25/pk



121518 5.75 in. x 3 in. B-837 25/pk

121519 5.75 in. x 3 in. B-851 25/pk

121520 5.75 in. x 3 in. B-853 25/pk



Mini Safety Lockout Tags

- Heavy-duty plastic tag includes metal grommet for added durability
- Small size makes them ideal for use within electrical panels
- Fasteners sold separately

Catalog #	Description	Size	Qty.
148824	Mini Tag	2.5 in. x 2 in.	25
81762	Nylon Fasteners	7 in.	100



Self-Laminating Photo Tags

- Include employee photos for easy identification and greater impact
- Constructed of durable B-851 polyester
- Available with or without 1 mil polyester overlay on front
- Includes nylon fasteners



Catalog #	Description	Size	Qty.
65500	Unlaminated Photo Tag	5.75 in. x 3 in.	25
65501	Photo Tag w/ Laminate	5.75 in. x 3 in.	10
96222	Photo Tag w/ Laminate	7 in. x 4 in.	10



Detachable Key Stub Tags

- Perforated heavy cardstock tag with detachable key stub
- Matching identification numbers printed on each part
- Includes tie strings and rings for attaching stubs to keys

Catalog #	Legend	Size	Qty.
WKT2	Equipment Locked Out	5.75 in. x 3 in.	25
WKT3	Do Not Operate	5.75 in. x 3 in.	25



Padlock Tags

- 0.375 in. metal grommet that fits over most lock shackles
- Dimensions: 3 in. x 2 in. (grommet adds 1 in. to height)

Catalog #	Legend	Size	Qty.
105722	Equipment Locked Out	3 in. x 2 in. plus grommet	1
105723	Do Not Operate	3 in. x 2 in. plus grommet	1
105724	Do Not Operate English/Spanish	3 in. x 2 in. plus grommet	1

Two-Part Perforated Tags

- Remove stub when tag is installed. Only the employee in possession of the stub has the authority to remove. After job is completed, return stub to management for verification and monitoring of tagout activity
- Matching identification numbers printed on each part of tag

Catalog #	Legend	B-#	Size	Qty.
PLLT2	Locked Out	B-851 polyester	7.5 in. x 4 in.	25
CLT2	Locked Out	B-853 cardstock	7.5 in. x 4 in.	25
PLLT4	Do Not Operate	B-851 polyester	7.5 in. x 4 in.	25
CLT4	Do Not Operate	B-853 cardstock	7.5 in. x 4 in.	25

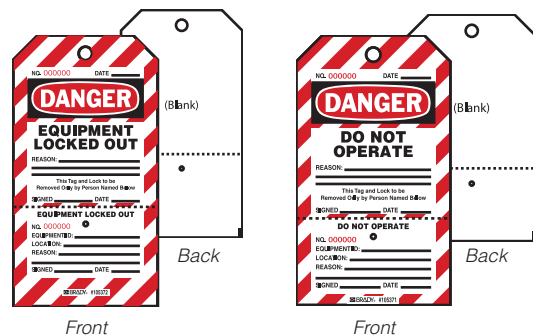

Energy Source Tags

BradyID.com/s36

Energy Source Tags

Energy source tags can be used to mark your facility's points of control for energy sources. These tags help make the lockout process quicker, safer and easier.

These energy source tags are made of plastic and available with color coded and alpha numeric options. A variety of pre-printed energy source tags are available or they can be customized to meet your specific application.

- 1.5 in. x 3 in. tags are constructed with B-401 rigid plastic
- Rounded corners and one hole included
- Choice of number legends supports machines with multiple energy points



Lockout Tagout

	Catalog #	Legend	Color	Qty.
Control Panel				
	105634	CP-1	Orange on White	5
	105674	CP-1	Orange on White	25
	105635	CP-2	Orange on White	5
	105675	CP-2	Orange on White	25
	105636	CP-3	Orange on White	5
	105676	CP-3	Orange on White	25
	105637	CP-4	Orange on White	5
	105677	CP-4	Orange on White	25
	105638	CP-5	Orange on White	5
	105673	CP-5	Orange on White	25

Control Panel tags supplied with an adhesive back.

	Catalog #	Legend	Color	Qty.
Electrical				
	105639	E-1	Red on White	5
	105679	E-1	Red on White	25
	105640	E-2	Red on White	5
	105680	E-2	Red on White	25
	105641	E-3	Red on White	5
	105681	E-3	Red on White	25
	105642	E-4	Red on White	5
	105682	E-4	Red on White	25
	105643	E-5	Red on White	5
	105683	E-5	Red on White	25

Electrical tags supplied with an adhesive back.

	Catalog #	Legend	Color	Qty.
Gas				
	105669	G-1	Purple on White	5
	105709	G-1	Purple on White	25
	105670	G-2	Purple on White	5
	105710	G-2	Purple on White	25
	105671	G-3	Purple on White	5
	105711	G-3	Purple on White	25
	105672	G-4	Purple on White	5
	105712	G-4	Purple on White	25
	105673	G-5	Purple on White	5
	105713	G-5	Purple on White	25

	Catalog #	Legend	Color	Qty.
Pneumatic / Air				
	105654	P-1	White on Blue	5
	105694	P-1	White on Blue	25
	105655	P-2	White on Blue	5
	105695	P-2	White on Blue	25
	105656	P-3	White on Blue	5
	105696	P-3	White on Blue	25
	105657	P-4	White on Blue	5
	105697	P-4	White on Blue	25
	105658	P-5	White on Blue	5
	105698	P-5	White on Blue	25

	Catalog #	Legend	Color	Qty.
Steam Red				
	105649	S-1	White on Red	5
	105689	S-1	White on Red	25
	105650	S-2	White on Red	5
	105690	S-2	White on Red	25
	105651	S-3	White on Red	5
	105691	S-3	White on Red	25
	105652	S-4	White on Red	5
	105692	S-4	White on Red	25
	105653	S-5	White on Red	5
	105693	S-5	White on Red	25

	Catalog #	Legend	Color	Qty.
Steam Orange				
	105659	S-1	Black on Orange	5
	105699	S-1	Black on Orange	25
	105660	S-2	Black on Orange	5
	105700	S-2	Black on Orange	25
	105661	S-3	Black on Orange	5
	105701	S-3	Black on Orange	25
	105662	S-4	Black on Orange	5
	105702	S-4	Black on Orange	25
	105663	S-5	Black on Orange	5
	105703	S-5	Black on Orange	25

	Catalog #	Legend	Color	Qty.
Valve				
	105664	V-1	Black on White	5
	105704	V-1	Black on White	25
	105665	V-2	Black on White	5
	105705	V-2	Black on White	25
	105666	V-3	Black on White	5
	105706	V-3	Black on White	25
	105667	V-4	Black on White	5
	105707	V-4	Black on White	25
	105668	V-5	Black on White	5
	105708	V-5	Black on White	25

	Catalog #	Legend	Color	Qty.
Water				
	105644	W-1	White on Green	5
	105684	W-1	White on Green	25
	105645	W-2	White on Green	5
	105685	W-2	White on Green	25
	105646	W-3	White on Green	5
	105686	W-3	White on Green	25
	105647	W-4	White on Green	5
	105687	W-4	White on Green	25
	105648	W-5	White on Green	5
	105688	W-5	White on Green	25



1-Pocket Tag Holder

- Clear plastic holder is designed to hold 50 tags, ties and a marking pen (Tags and pen not included)
- Comes with adhesive strips, magnetic strips and screws for mounting
- Dimensions: 7.5 in. x 4.5 in. x 1.5 in.

Catalog #	Description
TH2	1-Pocket Economy Tag Holder

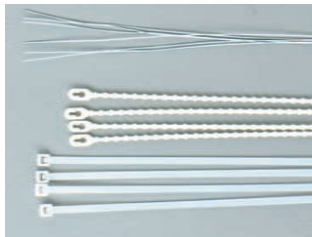

Tag Fasteners

- Three fastener styles available to meet every application
- Nylon fasteners meet OSHA requirements for attaching to devices

Catalog #	Description	Qty.
81760	12 in. 26 Gauge Wire	100
81761	8 in. Reusable Beaded Ties	100
81762	7 in. Nylon Fasteners	100



Pocket Premium Tag Center

- Acrylic center features 8 pockets for displaying and dispensing tags
- Each pocket holds up to 30 tags
- Four pre-drilled holes for wall mounting
- Board: 15.75 in. x 23.5 in. x 2 in.
- Pockets: 4.5 in. x 3.5 in.

Catalog #	Description
TC8	8-Pocket Premium Tag Center



Magnetic-Backed Protective Envelopes

- Transparent, durable vinyl construction makes it ideal for indoor or outdoor use
- Protects tags and data cards on machinery, valves, switches and more

Catalog #	Size	Qty.
81769	4.5 in. x 6.5 in.	10
81770	5.5 in. x 8.5 in.	10



10-Pocket Tag Safety Station

- Made of rugged polycarbonate
- Four pre-drilled holes for wall mounting
- Dimensions: 22 in. x 16.5 in. x 2.25 in.
- Tags not included

Catalog #	Description
81773	10-Pocket Tag Safety Station



Zip-Lock Protective Envelopes

- Transparent, durable vinyl construction makes it ideal for indoor or outdoor use
- Protects tags and data cards on machinery, valves, switches and more

Catalog #	Size	Qty.
81765	4.5 in. x 6.5 in. (w/o grommet)	10
81766	4.5 in. x 6.5 in. (w/grommet)	10
81767	5.5 in. x 8.5 in. (w/o grommet)	10
81768	5.5 in. x 8.5 in. (w/grommet)	10

Lockout Tagout

Safety, facility and inspections tags available on page 318.



Cable Lockouts

BradyID.com/s36

Cable Lockouts

Cable lockouts provide a number of advantages. Because of their construction, cable lockouts can be used in a variety of applications locking out multiple disconnects and valves. They are also a great option for lockout of unusual energy isolating devices that cannot be effectively locked out by a traditional device. This versatility, combined with ultimate portability, makes cable lockout devices a great addition to any lockout tagout program.

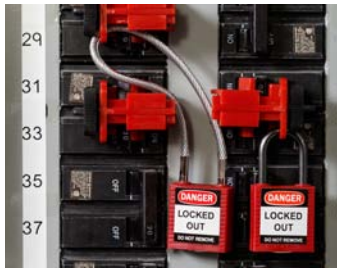

Compact Cable Padlocks

- Compact 1.31 in. x 1.25 in. nylon body with either 7.87 in. or 15.75 in. elongated, flexible cable as the shackle
- Allows you to secure breaker and still close the panel door
- Flexible cable means you can angle and twist padlock or lockout multiple energy isolation points with one lock

Color	Cable Length	1 Pack Keyed Different	6 Pack Keyed Alike
Red	7.87 in. cable	146120	146128
Red	15.75 in. cable	146124	146132
Yellow	7.87 in. cable	146121	146129
Yellow	15.75 in. cable	146125	146133
Blue	7.87 in. cable	146122	146130
Blue	15.75 in. cable	146126	146134
Green	7.87 in. cable	146123	146131
Green	15.75 in. cable	146127	146135



SAFELEX™ Universal Cable Lockout

- Integrated hasp and cable provides simple way to lockout multiple energy isolation points
- Ability to tighten the cable after the body is locked
- Available with steel or non-conductive nylon cable

Catalog #	Description	Qty
145554	Lockout w/ 3 ft. steel cable	1
145553	Lockout w/ 6 ft. steel cable	1
145552	Lockout w/ 10 ft. steel cable	1
145551	Lockout w/ 15 ft. steel cable	1
145550	Lockout w/ 6 ft. non-conductive nylon cable	1
145549	Lockout w/ 10 ft. non-conductive nylon cable	1

Padlocks sold separately.

Lockout Tagout

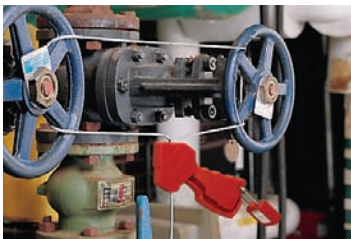

Cable Lockout

- Device constructed of impact modified nylon
- Includes 6 ft. galvanized steel cable (0.125 in. outside dia.)

Catalog #	Description	Color	Qty
65318	Cable Lockout Device w/ 6 ft. cable	Red	1
45191	Cable Lockout Device w/ 6 ft. cable	Blue	1
45192	Cable Lockout Device w/ 6 ft. cable	Yellow	1
65319	8 ft. steel cable only	-	1
65320	10 ft. steel cable only	-	1

*Other cable lengths available upon request. Padlocks sold separately.



Mini Cable Lockout

- Compact and portable with internally stored cable
- Push-button self-winding mechanism automatically cinches cable tight
- Superior chemical, corrosion and temperature resistance
- 6 lock holes fit most padlock shackles and hasps
- Body dimensions: 4 in. dia. x 1.75 in. deep
Cable dimensions: 0.06 in. outside dia. x 8 ft. length

Catalog #	Description	Qty
50940	Mini Cable Lockout w/ 8 ft. steel cable	1
51442	Mini Cable Lockout w/ 8 ft. nylon cable	1

Padlocks sold separately.



ProLock Cable Lockout

- Economical, highly visible cable lockout device
- Features flexible 0.125 in. diameter cables
- Double Hex ProLock offers versatile security as it can be operated by a standard wrench or ProLock Operating Tool
- Extra Secure ProLock device provides enhanced security as it requires the use of the ProLock Operating Tool

Description	Red	Yellow	Green
Extra Secure ProLock System* w/ 59 in. Cable and ProLock Operating Tool	122250	-	122252
Extra Secure ProLock w/ 59 in. Cable*	122241	122242	122243
Extra Secure ProLock w/o Cable*	122244	122245	122246
Double Hex ProLock w/ 59 in. Cable	122253	122254	122255
Double Hex ProLock w/o Cable	122247	122248	122249
4.92 ft Cable Spool	122260	122261	122262
164 ft Cable Spool	122263	122264	122265
ProLock Operating Tool	122256	-	122258

* Extra Secure ProLock requires the use of the ProLock Operating Tool. Padlocks sold separately.



Double-Looped Cables

- Light weight and easier to spot; perfect for situations requiring a flexible lockout device and a visual deterrent
- 0.187 in. diameter cables

Catalog #	Length	Color
131063	2 ft. Double Looped Cable	Red
131064	4 ft. Double Looped Cable	Red
131065	6 ft. Double Looped Cable	Red
131066	8 ft. Double Looped Cable	Red

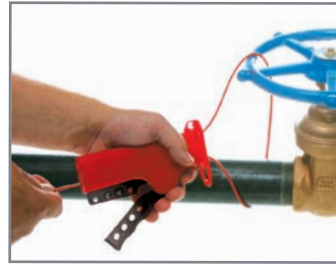

All-Purpose Cable Lockout

- Superior chemical, corrosion and temperature resistance
- Available with interchangeable cables
- Service temps of cables:
Non-conductive nylon: -40° to 200° F
Sheathed metal: -30° to 180° F

Catalog #	Description
50943	Lockout w/ 8 ft. sheathed metal cable
50941	Lockout w/ 8 ft. non-conductive nylon cable
50944	Lockout without cable
50947	8 ft. Sheathed metal cable only
50950	12 ft. Sheathed metal cable only
50953	16 ft. Sheathed metal cable only
50956	20 ft. Sheathed metal cable only
50945	8 ft. Non-conductive nylon cable only
50948	12 ft. Non-conductive nylon cable only
50951	16 ft. Non-conductive nylon cable only
50954	20 ft. Non-conductive nylon cable only

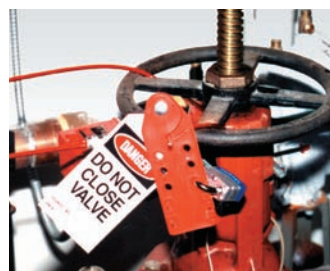

Economy Cable Lockout

- Device accepts up to six padlocks with 0.28 in. dia.
- Includes 6 ft. or 10 ft. plastic-coated steel cable
- Cable diameter: 0.187 in.

Catalog #	Description	Qty.
CABLO	Cable Lockout w/ 6 ft. cable	1
CABLO-10	Cable Lockout w/ 10 ft. cable	1
CABLE	6 ft. cable only	1
CABLE-10FT	10 ft. cable only	1

Valve Lockouts

BradyID.com/s36

Valve Lockouts

From universal valve lockouts to pipe blind flange lockouts, Brady offers a full line of devices to lock out a wide variety of valve types and sizes. Our small lockout devices will lock pipes with diameters measuring from 0.5 in. to 3 in., while our large ball valve lockout devices can lock out pipes up to 8 in. diameter.

Butterfly Valve Lockout

- Innovative design to lock out butterfly valves with a lever handle in the OFF position
- Accommodates handle thicknesses of:
Small - 0.125 in. to 2.25 in.
Large - 2 in. to 4 in.

Catalog #	Description
121504	Butterfly Valve Lockout - Small
121505	Butterfly Valve Lockout - Large



Lockout Tagout

Pipe Blind Flange Lockout Device

- Adjustable locking arm accommodates both standard and recessed bolt positions
- Secures 1 or 2 bolts for extra security
- Versatile to accept up to 4 padlocks
- Heavy-duty construction withstands harsh environments
- UL approved for use in explosive atmospheres

Catalog #	Description	Fits	Qty
149228	Small Blind Flange Lockout	0.5 in. to 3 in. diameter pipes	1
149229	Medium Blind Flange Lockout	3 in. to 14 in. diameter pipes	1
149230	Large Blind Flange Lockout	14 in. to 48 in. diameter pipes	1



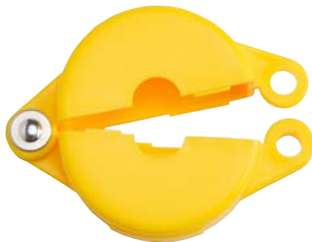

Gate Valve Lockouts

- Unique knockout center fits OS&Y or rising stem valves
- Made of rugged injection-molded polypropylene
- Service temps from -25° F to 200° F
- Accepts shackles up to 0.375 in. diameter
- Supplied with English, Spanish and French danger labels

Fits Valve Handles Dia.	Red	Yellow	Green	Blue
1 in. to 2.5 in.	65560	65590	65595	65585
2.5 in. to 5 in.	65561	65591	65596	65586
5 in. to 6.5 in.	65562	65592	65597	65587
6.5 in. to 10 in.	65563	65593	65598	65588
10 in. to 13 in.	65564	65594	65599	65589



Adjustable Gate Valve Lockout

- Versatile lockout adjusts to fit 1 in. to 6.5 in. valve handles, replacing 3 conventional gate valve lockouts
- Constructed of rugged injection-molded polypropylene
- Service temps from -13° F to 194° F
- Supplied with English, Spanish and French danger labels

Catalog #	Description	Qty
64057	Adjustable Gate Valve Lockout	1



Transparent Gate Valve Lockout

- Visually confirms the appropriate position, identifies valve leaks and helps ensure safety
- Constructed of a rugged injection-molded polypropylene
- Service temps from -40° F to 302° F
- Accept shackles up to 0.375 in. diameter

Catalog #	Description	Fits Valve Handles	Qty
145581	Transparent Valve Gate Lockout	1 in. to 2.5 in. dia.	1
145582	Transparent Valve Gate Lockout	2.5 in. to 5 in. dia.	1
145583	Transparent Valve Gate Lockout	5 in. to 6.5 in. dia.	1
145584	Transparent Valve Gate Lockout	6.5 in. to 10 in. dia.	1
145585	Transparent Valve Gate Lockout	10 in. to 13 in. dia.	1



Collapsible Gate Valve Lockout

- Folds into smaller sizes for easy storage
- Cover rotates into fully engaged position
- Rugged injection-molded styrene construction
- 3 device sizes to secure valves up to 18 in. handle diameter

Catalog #	Description	Fits Handles	Qty
148648	Collapsible Gate Valve Lockout	3 in. to 7 in. dia.	1
148647	Collapsible Gate Valve Lockout	7 in. to 13 in. dia.	1
148646	Collapsible Gate Valve Lockout	13 in. to 18 in. dia.	1

Valve Lockouts

BradyID.com/s36



Perma-Mount™ Ball Valve Lockout

- Retrofit devices are meant to stay permanently in place at the point of need
- One-time installation is easy to complete in just a few minutes
- Available in 2 sizes to fit a full range of 0.5 in. to 4 in. diameter ball valves

Catalog #	Size	Ball Valve Dia.	Qty
121540	Small Perma-Mount Ball Valve Lockout	0.5 in. to 2 in.	1
121541	Large Perma-Mount Ball Valve Lockout	2 in. to 4 in.	1



Plug Valve Lockout

- Ideal for difficult-to-secure plug valves in compliance with OSHA standards
- Various sizes to fit most 1 in. to 8 in. diameter manually-actuated plug valves
- Durable and tamper-resistant with service temperatures from -25° F to 200° F
- Compact in size and easy to use

Catalog #	Description	Valve Stem Dia.	Qty
113231	Plug Valve Lockout	Up to 0.875 in. stem dia.	1
113232	Plug Valve Lockout	0.94 in. to 1.375 in. stem dia.	1
113233	Plug Valve Lockout	1.75 in. to 2.125 in. stem dia.	1
113234	Plug Valve Lockout	2.188 in. to 2.5 in. stem dia.	1

Lockout Tagout



4-Legged Ball Valve Lockout

- Made from ultra-tough polypropylene
- Small size locks out pipes 0.5 in. to 2.5 in. diameter and can also lock valves OPEN on pipes from 0.5 in. to 1.25 in.
- Large size locks out pipes 2 in. to 8 in. diameter

Small	Size	Valve Size	Color	Qty.
BS07A-RD	Small	0.5 in. to 2.5 in. dia.	Red	1
BS07A-YW	Small	0.5 in. to 2.5 in. dia.	Yellow	1
BS07A-BU	Small	0.5 in. to 2.5 in. dia.	Blue	1
BS07A-GN	Small	0.5 in. to 2.5 in. dia.	Green	1
BS08A-RD	Large	2 in. to 8 in. dia.	Red	1
BS08A-YW	Large	2 in. to 8 in. dia.	Yellow	1
BS08A-BU	Large	2 in. to 8 in. dia.	Blue	1
BS08A-GN	Large	2 in. to 8 in. dia.	Green	1



Standard Ball Valve Lockout

- Easy to use, single-piece design locks quarter-turn ball valves in OFF position
- Two sizes fit most valves up to 3 in.
- Made of either super-tough nylon (service temp -40° to 248° F) or powder-coated steel

Catalog #	Material	Max Shackle Dia.	Valve Size / Pipe Dia.	Max Handle Width	Max Handle Thickness
65666	Nylon	0.28 in.	0.25 in. to 1 in.	1.5 in.	0.75 in.
65692	Steel	0.375 in.	0.25 in. to 1 in.	1.5 in.	0.75 in.
65669	Steel	0.28 in.	1.25 in. to 3 in.	2.1 in.	1.25 in.
65693	Steel	0.375 in.	1.25 in. to 3 in.	1.9 in.	1.25 in.

Universal Valve Lockout (UVLO)

Lock out all types of valves with a single device

- Made of rugged industrial-grade steel and nylon for extra impact and chemical resistance
- Versatile open-ended clamp fits over most closed rings, wide handles
- Can also lock out large levers, T-handles and other hard-to-secure mechanical devices
- Cable attachment offers choice of 0.125 in. non-conductive nylon or rustproof sheathed metal cable
- Small lockout for handle widths up to 1 in. (max handle thickness 0.6 in.)
- Large lockout for handle widths up to 1.6 in. (max handle thickness 1.1 in.)



Full Solution

Catalog #	Description	For Handle Width
51394	Small Device, 8 ft. Sheathed Cable, Blocking Arm	Up to 1 in. (max thickness 0.6 in.)
51390	Small Device, 8 ft. Nylon Cable, Blocking Arm	Up to 1 in. (max thickness 0.6 in.)
51392	Large Device, 8 ft. Sheathed Cable, Blocking Arm	Up to 1.6 in. (max thickness 1.1 in.)
51388	Large Device, 8 ft. Nylon Cable, Blocking Arm	Up to 1.6 in. (max thickness 1.1 in.)

Individual Components

Catalog #	Description	For Handle Width
50924	Small UVLO Base Clamping Unit	Up to 1 in. (max thickness 0.6 in.)
50899	Large UVLO Base Clamping Unit	Up to 1.6 in. (max thickness 1.1 in.)
65402	Small Blocking Arm	
65403	Large Blocking Arm	
51395	Cable Attachment with 8 ft. Sheathed Cable	
50932	Cable Attachment with 8 ft. Nylon Cable	
50947	8 ft. Sheathed Metal Cable	
50950	12 ft. Sheathed Metal Cable	
50953	16 ft. Sheathed Metal Cable	
50956	20 ft. Sheathed Metal Cable	
50945	8 ft. Nonconductive Nylon Cable	
50948	12 ft. Nonconductive Nylon Cable	
50951	16 ft. Nonconductive Nylon Cable	
50954	20 ft. Nonconductive Nylon Cable	



Use blocking arm to lock out quarter-turn ball valves

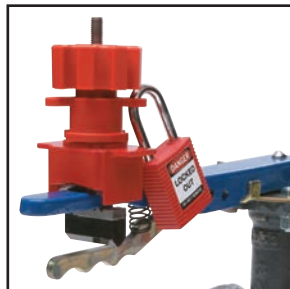

Attach to butterfly handles to prevent trigger handle from being squeezed.



Use cable attachment to lock out gate valves

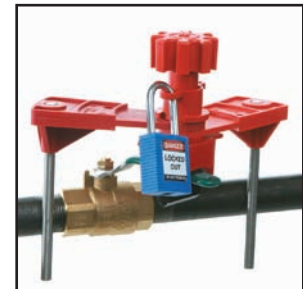

Use two blocking arms to lock out 3-, 4- or 5-way valves, or to lock in the ON, OFF, or throttled position

Lockout Tagout

Circuit Breaker Lockouts

BradyID.com/s36



Circuit Breaker Lockout Compatibility Guide

Brady offers a wide variety of lockouts to isolate and secure most circuit breaker switches. From standard snap-on and clamp-on models to oversized, multi-pole and miniature options, Brady is sure to have what you need.

Use the guide below to find the correct lockout device for your circuit breakers.

Lockout Tagout

Brand	Model No.	Poles	Compatible Part #
ABB	E221	1	90844
ABB	E222	2	90844
ABB	E241	1	90844
ABB	E242	2	90844
ABB	E243	3	90844
ABB	E244	4	90844
ABB	E271	1	90844
ABB	E272	2	90844
ABB	E273	3	90844
ABB	E274	4	90844
ABB	F202AC	2	90850
ABB	F204AC	4	90850
ABB	F362	2	90844
ABB	F364	4	90844
ABB	F374	4	90844, 149514
ABB	F672	2	90850
ABB	F674	4	90850
ABB	JS	2-3	65397*, 148701*
ABB	MS325	3	149433
ABB	S1	3	65396, 148690
ABB	S201-B	1	90844
ABB	S201-C	1	90844
ABB	S201-D	1	90844
ABB	S201-K	1	90844
ABB	S201P-K	1	90844
ABB	S201P-Z	1	90844
ABB	S201U-K	1	90844
ABB	S201U-Z	1	90844
ABB	S201UP-K	1	90844
ABB	S201UP-Z	1	90844
ABB	S202-B	2	90844
ABB	S202-C	2	90844
ABB	S202-D	2	90844
ABB	S202-K	2	90844
ABB	S202P-K	2	90844
ABB	S202P-Z	2	90844
ABB	S202U-K	2	90844
ABB	S202U-Z	2	90844
ABB	S202UP-K	2	90844
ABB	S202UP-Z	2	90844
ABB	S203-B	3	90844
ABB	S203-C	3	90844
ABB	S203-D	3	90844
ABB	S203-K	3	90844
ABB	S203P-K	3	90844
ABB	S203P-Z	3	90844
ABB	S203U-K	3	90844
ABB	S203U-Z	3	90844
ABB	S203UP-K	3	90844
ABB	S203UP-Z	3	90844
ABB	S204-B	4	90844
ABB	S204-C	4	90844
ABB	S204-K	4	90844
ABB	S204U-K	4	90844
ABB	S204U-Z	4	90844
ABB	S204UP-K	4	90844
ABB	S204UP-Z	4	90844
ABB	S221	1	90844
ABB	S222	2	90844, 149514
ABB	S222-K	4	90844
ABB	S223	3	90844
ABB	S224	4	90844
ABB	S251	1	90844, 149514
ABB	S252	2	90844

Brand	Model No.	Poles	Compatible Part #
ABB	S253	3	90844, 149514
ABB	S261	1	90844, 149514
ABB	S261-B	1	90844
ABB	S261-C	1	90844
ABB	S261-D	1	90844
ABB	S262-B	2	90844
ABB	S262-C	2	90844
ABB	S262-D	2	90844
ABB	S263	1	90844, 149514
ABB	S263-B	3	90844
ABB	S263-C	3	90844
ABB	S263-D	3	90844
ABB	S264-B	4	90844
ABB	S264-C	4	90844
ABB	S271-K	1	90844
ABB	S272	1	90844, 149514
ABB	S272-K	2	90844
ABB	S273-K	3	90844
ABB	S274-K	4	90844
ABB	S281-K	1	90844
ABB	S281-Z	1	90850
ABB	S281UC-K	1	90844
ABB	S281UC-Z	1	90850
ABB	S282-K	2	90844
ABB	S282-Z	2	90850
ABB	S282UC-K	2	90844
ABB	S282UC-Z	2	90850
ABB	S283-K	3	90844
ABB	S283-Z	3	90850
ABB	S283UC-K	3	90844
ABB	S283UC-Z	3	90850
ABB	S3	3	65397*, 148701*
ABB	S501-B	1	90850
ABB	S501-C	1	90850
ABB	S501-D	1	90850
ABB	S501-K	1	90850
ABB	S501UC-B	1	90850
ABB	S501UC-K	1	90850
ABB	S502-B	2	90850
ABB	S502-C	2	90850
ABB	S502-D	2	90850
ABB	S502-K	2	90850
ABB	S502UC-B	2	90850
ABB	S502UC-K	2	90850
ABB	S503-B	3	90850
ABB	S503-C	3	90850
ABB	S503-D	3	90850
ABB	S503-K	3	90850
ABB	S503UC-B	3	90850
ABB	S503UC-K	3	90850
ABB	S504UC-B	4	90850
ABB	S504UC-K	4	90850
AEG	E82S	2	90847
Airpax	Airpax	1	65396*, 148690*
Allen Bradley	1492-CB1DF	1	90844
Allen Bradley	1492-CB1DG	1	90844
Allen Bradley	1492-CB1DH	1	90844
Allen Bradley	1492-CB1F	1	90844
Allen Bradley	1492-CB1G	1	90844
Allen Bradley	1492-CB1H	1	90844
Allen Bradley	1492-CB2DF	2	90844
Allen Bradley	1492-CB2DG	2	90844
Allen Bradley	1492-CB2DH	2	90844
Allen Bradley	1492-CB2F	2	90844

Brand	Model No.	Poles	Compatible Part #
Allen Bradley	1492-CB2G	2	90844
Allen Bradley	1492-CB2H	2	90844
Allen Bradley	1492-CB3F	3	90844
Allen Bradley	1492-CB3G	3	90844
Allen Bradley	1492-CB3H	3	90844
Allen-Bradley	1492-CB1	1	90844
Allen-Bradley	1492-CB2	2	90844
Allen-Bradley	1492-CB3	3	90844
American Ckt. Bkr.	NEF	3	65396*, 148690*
American Ckt. Bkr.	NJ	3	65397*, 148701*, 65329, 148692
American Switch	C	1	65396*, 148690*, 51252, 148696, 51254
Bryant	BR	2-3	66321, 148702, 51254
Bryant	BR	1	65387, 148689, 65396, 148690, 51254
Buschmat	S46	1	90844
Challenger	C	2-3	66321, 148702, 51254
Challenger	C	1	65387, 148689, 65396, 148690, 51254
Challenger	CDK	2-3	65397, 148701
Challenger	LM	1	65396, 148690
Challenger	NEJ	1-2	65396*, 148690*, 51254
Clipsal	4CB	1-3	90844
Clipsal	4CB116	1	90844
Clipsal	4CB320	3	90844
Crouse-Hinds	MP	2	66321, 148702, 51254
Cutler-Hammer	BA	1	65396, 148690, 51254
Cutler-Hammer	BAB	2-3	66321, 148702
Cutler-Hammer	BAB	1	65387, 148689, 65396, 148690, 51254
Cutler-Hammer	BD	1	65387, 148689, 65396, 148690, 51254
Cutler-Hammer	BR	2-3	66321, 148702, 51254
Cutler-Hammer	BR	1	65387, 148689, 65396, 148690, 51254
Cutler-Hammer	BRH	2-3	66321, 148702, 51254
Cutler-Hammer	BRH	1	65387, 148689, 65396, 148690, 51254
Cutler-Hammer	BRHH	2	66321, 148702, 51254
Cutler-Hammer	CC	3	65397*, 148701*
Cutler-Hammer	CH	2-3	66321, 148702, 51254
Cutler-Hammer	CH	1	65387, 148689, 65396, 148690, 51252, 148696, 51254
Cutler-Hammer	CH2	4	66321, 148702, 51254
Cutler-Hammer	CHB	2-3	66321, 148702, 51254
Cutler-Hammer	CHB	1	65387, 148689, 65396, 148690, 51252, 148696, 51254
Cutler-Hammer	CHH	3	65396*, 148690*
Cutler-Hammer	CHKD	2-3	65397, 148701
Cutler-Hammer	CHLD	2-4	65329, 148692
Cutler-Hammer	CHMDL	2-3	65329, 148692
Cutler-Hammer	CHND	2-4	65397*, 148701*
Cutler-Hammer	CHP	2-3	66321, 148702, 51254
Cutler-Hammer	CHP	1	65387, 148689, 65396, 148690, 51252, 148696, 51254
Cutler-Hammer	CHQ	1	65396, 148690, 51254
Cutler-Hammer	CHQ	2	66321, 148702, 51254
Cutler-Hammer	CHSW	2-3	66321, 148702, 51254
Cutler-Hammer	CKD	2-3	65397, 148701
Cutler-Hammer	CL	1	65387, 148689, 65396, 148690, 51252, 148696, 51254
Cutler-Hammer	CL	2	66321, 148702, 51254

*Requires use of a cleat.

Circuit Breaker Lockout Compatibility Guide (continued)

Brand	Model No.	Poles	Compatible Part #
Cutler-Hammer	CLD	2-4	65329, 148692
Cutler-Hammer	CLDC	2-4	65329, 148692
Cutler-Hammer	CMDL	2-3	65329, 148692
Cutler-Hammer	CND	2-4	65397*, 148701*
Cutler-Hammer	CNDC	2-4	65397*, 148701*
Cutler-Hammer	CSR	1	65396, 148690, 51254
Cutler-Hammer	DK	2-3	65397, 148701
Cutler-Hammer	E125B	1-4	65396, 148690, 51254
Cutler-Hammer	E125E	1-4	65396, 148690, 51254
Cutler-Hammer	E125H	1-4	65396, 148690, 51254
Cutler-Hammer	E125S	1-4	65396, 148690, 51254
Cutler-Hammer	ED	2-4	65396, 148690, 51254
Cutler-Hammer	EDC	2-4	65396, 148690, 51254
Cutler-Hammer	EDH	2-4	65396, 148690, 51254
Cutler-Hammer	EFH	1-4	65396, 148690, 51254
Cutler-Hammer	EGB	1-4	65396, 148690, 51254
Cutler-Hammer	EGE	1-4	65396, 148690, 51254
Cutler-Hammer	EGS	1-4	65396, 148690, 51254
Cutler-Hammer	EHC	1-4	65396, 148690, 51254
Cutler-Hammer	EHD	1-4	65396, 148690, 51254
Cutler-Hammer	FB	2-3	65396, 148690, 51254
Cutler-Hammer	FC	1-4	65396, 148690, 51254
Cutler-Hammer	FD	1-4	65396, 148690, 51254
Cutler-Hammer	FDB	2-4	65396, 148690, 51254
Cutler-Hammer	FDC	2-4	65396, 148690, 51254
Cutler-Hammer	FS	2-3	65396, 148690, 51254
Cutler-Hammer	GB	1-3	65396, 148690, 51254
Cutler-Hammer	GC	1-3	65396, 148690, 51254
Cutler-Hammer	GD	1-3	65396, 148690, 51254
Cutler-Hammer	GDB	1-3	65396, 148690, 51254
Cutler-Hammer	GHB	1-3	65396, 148690, 51254
Cutler-Hammer	GHBGFEP	1	65396, 148690, 51254
Cutler-Hammer	GHC	1-3	65396, 148690, 51254
Cutler-Hammer	GHCGFEP	1	65396, 148690, 51254
Cutler-Hammer	HBAW	2-3	66321, 148702
Cutler-Hammer	HBAW	1	65387, 148689, 65396, 148690, 51254
Cutler-Hammer	HBAX	2-3	66321, 148702
Cutler-Hammer	HBAX	1	65387, 148689, 65396, 148690, 51254
Cutler-Hammer	HFD	1-4	65396, 148690, 51254
Cutler-Hammer	HGHB	1	65396, 148690, 51254
Cutler-Hammer	HGHC	1	65396, 148690, 51254
Cutler-Hammer	HJD	2-4	65397, 148701
Cutler-Hammer	HKD	2-4	65397, 148701
Cutler-Hammer	HLD	2-4	65329, 148692
Cutler-Hammer	HMCP	2-3	65396, 148690, 65397, 148701, 65329, 148692
Cutler-Hammer	HMDL	2-3	65329, 148692
Cutler-Hammer	HMDLB	2-3	65329, 148692
Cutler-Hammer	HMPL	3	65397*, 148701*, 65329, 148692
Cutler-Hammer	HND	2-4	65397*, 148701*
Cutler-Hammer	HQP	2	66321, 148702
Cutler-Hammer	HQP	1	65387, 148689, 65396, 148690, 51254
Cutler-Hammer	JD	2-4	65397, 148701
Cutler-Hammer	JDB	2-3	65397, 148701
Cutler-Hammer	JDC	2-4	65397, 148701
Cutler-Hammer	KD	2-4	65397, 148701
Cutler-Hammer	KDB	2-4	65397, 148701
Cutler-Hammer	KDC	2-4	65397, 148701

Brand	Model No.	Poles	Compatible Part #
Cutler-Hammer	LA	2-3	65397, 148701
Cutler-Hammer	LD	2-4	65329, 148692
Cutler-Hammer	LDB	2-3	65329, 148692
Cutler-Hammer	LDC	2-4	65329, 148692
Cutler-Hammer	LH	3	65397, 148701
Cutler-Hammer	LHB	3	65397, 148701
Cutler-Hammer	LJ	3	51254
Cutler-Hammer	MA	2-3	65397*, 148701*
Cutler-Hammer	MC	2-3	65397*, 148701*
Cutler-Hammer	MD	2-3	65329, 148692
Cutler-Hammer	MDL	2-3	65329, 148692
Cutler-Hammer	MDS	2-3	65329, 148692
Cutler-Hammer	NB	2-3	65329, 148692
Cutler-Hammer	ND	2-4	65397*, 148701*
Cutler-Hammer	NDC	2-4	65397*, 148701*
Cutler-Hammer	OPTIM	3	65397*, 148701*
Cutler-Hammer	PB	2-3	65329, 148692
Cutler-Hammer	QBGF	1	65396, 148690
Cutler-Hammer	QBGF	2	51254
Cutler-Hammer	QBGFEP	1	65396, 148690
Cutler-Hammer	QBGFEP	2	51254
Cutler-Hammer	QBHGF	1	65396, 148690
Cutler-Hammer	QBHGFEP	1	65396, 148690
Cutler-Hammer	QBHW	2-3	66321, 148702
Cutler-Hammer	QBHW	1	65387, 148689, 65396, 148690, 51254
Cutler-Hammer	QC	2-3	66321, 148702, 51254
Cutler-Hammer	QC	1	65387, 148689, 65396, 148690, 51254
Cutler-Hammer	QCD	2-3	66321, 148702, 51254
Cutler-Hammer	QCD	1	65387, 148689, 65396, 148690, 51254
Cutler-Hammer	QCGF	1	65396, 148690
Cutler-Hammer	QCGFEP	1	65396, 148690
Cutler-Hammer	QCHGF	1	65396, 148690
Cutler-Hammer	QCHGFEP	1	65396, 148690
Cutler-Hammer	QCHW	2-3	66321, 148702, 51254
Cutler-Hammer	QCHW	1	65387, 148689, 65396, 148690, 51254
Cutler-Hammer	QHCW	2-3	66321, 148702, 51254
Cutler-Hammer	QHCW	1	65387, 148689, 65396, 148690, 51254
Cutler-Hammer	QHCX	2-3	66321, 148702, 51254
Cutler-Hammer	QHCX	1	65387, 148689, 65396, 148690, 51254
Cutler-Hammer	QHPW	2-3	66321, 148702
Cutler-Hammer	QHPW	1	65387, 148689, 65396, 148690, 51254
Cutler-Hammer	QHPX	2-3	66321, 148702
Cutler-Hammer	QHPX	1	65387, 148689, 65396, 148690, 51254
Cutler-Hammer	QPGF	1	65396, 148690
Cutler-Hammer	QPGF	2	51254
Cutler-Hammer	QPGFEP	1	65396, 148690
Cutler-Hammer	QPGFEP	2	51254
Cutler-Hammer	QPHGF	1	65396, 148690
Cutler-Hammer	QPHGFEP	1	65396, 148690
Cutler-Hammer	QPHW	2-3	66321, 148702
Cutler-Hammer	QPHW	1	65387, 148689, 65396, 148690, 51254
Cutler-Hammer	WME	1-3	90844
Cutler-Hammer	WMF	1-3	90844

Brand	Model No.	Poles	Compatible Part #
Cutler-Hammer	WMH	1-4	90844
Cutler-Hammer	WMM	1-4	90844
Cutler-Hammer	WMN	1-4	90844
Cutler-Hammer	WMS	1-4	90844
Eaton	<i>Please see Cutler-Hammer brand.</i>		
E-T-A	911225	1	90847
E-T-A	911220G	2	90844
FAZ	C16	1-4	90844
Fed. Pacific Elec.	2B	2	51254
Fed. Pacific Elec.	BAB	1	65396, 148690, 51254
Fed. Pacific Elec.	NA-single	3	65397*, 148701*, 51254
Fed. Pacific Elec.	NA-tie bar	2	51254
Fed. Pacific Elec.	NB	1	65397*, 148701*, 51254
Fed. Pacific Elec.	NBH GFI	1	65396, 148690, 51254
Fed. Pacific Elec.	NE/NEF	1-3	65396*, 148690*
Fed. Pacific Elec.	NEJ	1-3	65396*, 148690*
Fed. Pacific Elec.	NFJ	1-3	65396, 148690
Fed. Pacific Elec.	NJJ	1-3	65397, 148701
Fed. Pacific Elec.	NJL	1-3	65397, 148701
Fed. Pacific Elec.	NM	1-3	65397, 148701
Fed. Pacific Elec.	NP-single	1	65396, 148690, 51254
Frank Adams	P	1	65396, 148690, 51254
FUJI Electric	BU-ESA	3	65396*, 148690*
FUJI Electric	BU-ESB	3	65396*, 148690*
FUJI Electric	BU-FSB	3	65396*, 148690*
FUJI Electric	EA203B	3	65396*, 148690*
FUJI Electric	EA53B	3	65396*, 148690*
GE Vynckier	Series E	1-4	90847
GE Vynckier	Series G	1-3	90847
General Electric	EH400	3	65397, 148701
General Electric	HQC	3	65396, 148690, 51254
General Electric	SED	2-3	65396, 148690, 51254
General Electric	SEH	2-3	65396, 148690, 51254
General Electric	SEL	2-3	65396, 148690, 51254
General Electric	SEP	2-3	65396, 148690, 51254
General Electric	SFH	2-3	65396, 148690, 51254
General Electric	SFL	2-3	65396, 148690, 51254
General Electric	SFP	2-3	65396, 148690, 51254
General Electric	SGD	2-3	65396, 148690
General Electric	SGH	2-3	65396, 148690
General Electric	SGL	2-3	65396, 148690
General Electric	SGLA	2-3	65396, 148690
General Electric	SGP	2-3	65396, 148690
General Electric	SRPG	3	65396, 148690
General Electric	TB	2	65396*, 148690*, 51254
General Electric	TBC	2	65396*, 148690*, 51254
General Electric	TE	1-3	65396*, 148690*, 51254
General Electric	TEB	1-3	65396*, 148690*, 51254
General Electric	TED	1-3	65396*, 148690*, 51254
General Electric	TEF	1-3	65396*, 148690*, 51254
General Electric	TEL	3	65396*, 148690*, 51254
General Electric	TEML	3	65396*, 148690*, 51254
General Electric	TEY	1-3	65396, 148690, 51254
General Electric	TF	1-3	65396, 148690, 51254
General Electric	TFC	3	65396*, 148690*, 51254
General Electric	TFJ	2-3	65397, 148701
General Electric	TFK	2-3	65397, 148701
General Electric	TFL	3	65397, 148701
General Electric	THED	1-3	65396*, 148690*, 51254
General Electric	THEF	1-3	65396*, 148690*, 51254
General Electric	THFK	2-3	65397, 148701

Lockout Tagout

Standard Circuit Breaker Lockouts



- 65387 148689**
120V
Snap-on lockout
- 65396 148690**
120/277V
Clamp-on lockout
- 65397 148701**
480/600V
Clamp-on lockout
- 65329 148692**
480/600V
Oversized lockout
- 66321 148702**
Universal multi-pole lockout

EZ Paneloc™ Lockouts



- 51252 148696**
Snap-on (SQD QO) lockout
- 51254**
Clamp-on (universal) lockout

Miniature Circuit Breaker Lockouts



- 90844**
Pin-out standard lockout
- 90847**
Pin-in standard lockout
- 90850**
Pin-out wide lockout
- 90853**
Tie-bar lockout
- 149433**
Rotary lockout
- 149514**
Universal lockout

*Requires use of a cleat.

Circuit Breaker Lockouts

BradyID.com/s36

Circuit Breaker Lockout Compatibility Guide (continued)

Brand	Model No.	Poles	Compatible Part #
General Electric	THHQB	2-3	66321, 148702, 51254
General Electric	THHQB-A	1	65387, 148689, 65396, 148690, 51254
General Electric	THHQB-S	1	65396, 148690, 51254
General Electric	THHQC	1-3	66321, 148702, 51254
General Electric	THHQC-A	1	65387, 148689, 65396, 148690, 51254
General Electric	THHQC-S	1	65396, 148690, 51254
General Electric	THHQL	2-3	66321, 148702, 51254
General Electric	THHQL-A	1	65387, 148689, 65396, 148690, 51254
General Electric	THHQL-S	1	65396, 148690, 51254
General Electric	THJK4	2-3	65397*, 148701*
General Electric	THJK6	2-3	65397*, 148701*
General Electric	THKM12	2-3	65329, 148692
General Electric	THKM8	2-3	65329, 148692
General Electric	THLC1	3	65396*, 148690*
General Electric	THQB	2-3	66321, 148702, 51254
General Electric	THQB-A	1	65387, 148689, 65396, 148690, 51254
General Electric	THQB-S	1	65396, 148690, 51254
General Electric	THQC	2-3	66321, 148702, 51254
General Electric	THQC-A	1	65387, 148689, 65396, 148690, 51254
General Electric	THQC-AL	2-3	66321, 148702, 51254
General Electric	THQC-S	1	65396, 148690, 51254
General Electric	THQD	2-3	65396*, 148690*, 51254
General Electric	THQDBL	3	51254
General Electric	THQL	2-3	66321, 148702, 51254
General Electric	THQL-A	1	65387, 148689, 65396, 148690, 51254
General Electric	THQL-S	1	65396, 148690, 51254
General Electric	TJ2	2-3	65397*, 148701*, 65329, 148692
General Electric	TJ4	3	65397, 148701
General Electric	TJC	2-3	65396*, 148690*, 51254
General Electric	TJD	2-3	65397*, 148701*
General Electric	TJJ	2-3	65397*, 148701*
General Electric	TJK	2-3	65397*, 148701*
General Electric	TJS	2-3	65397*, 148701*
General Electric	TK4V	3	65397, 148701
General Electric	TKC	3	65396*, 148690*, 51254
General Electric	TKM	2-3	65329, 148692
General Electric	TKMA8	3	65329, 148692
General Electric	TQB	2-3	66321, 148702, 51254
General Electric	TQB-A	1	65387, 148689, 65396, 148690, 51254
General Electric	TQB-S	1	65396, 148690, 51254
General Electric	TQC	2-3	66321, 148702, 51254
General Electric	TQC-A	1	65387, 148689, 65396, 148690, 51254
General Electric	TQC-S	1	65396, 148690, 51254
General Electric	TQD	2-3	65396, 148690
General Electric	TQL-A	1	65387, 148689, 65396, 148690, 51254
General Electric	TQL-S	1	65396, 148690, 51254
General Electric	V	1-3	90847
General Electric	V	1-4	90847
Hager	453717	3	90844, 149514
Hager	MW216A	2	90844, 149514
Hager	MW620A	4	90844, 149514
Heinemann	LB	1	65396*, 148690*
Heinemann	LF	1	65396*, 148690*
Heinemann	LJ	1	65396*, 148690*
Kapp	LS68	1	90844
Legrand	1908	1	90844
Legrand	1935	3	90844
Legrand	1980	3-4	90844
Legrand	4302	2	90847
Legrand	6469	3	90847
Lemag	SD62	1	65396, 148690
Merlin Gerin	B100A	2	90850, 90853
Merlin Gerin	B100A	2	90850, 90853
Merlin Gerin	C1251N	3	65329, 148692
Merlin Gerin	C32N	1-3	90844
Merlin Gerin	C45AD	3	90844

Brand	Model No.	Poles	Compatible Part #
Merlin Gerin	C60a	1-4	90844
Merlin Gerin	C60H	1-4	90844
Merlin Gerin	C60N	1-4	90844
Merlin Gerin	C801N	3	65329, 148692
Merlin Gerin	C80A	3	90850, 90853
Merlin Gerin	C80A	3	90850, 90853
Merlin Gerin	CE104N	3	65396*, 148690*
Merlin Gerin	CJ	3	65397*, 148701*
Merlin Gerin	CK1200NA	3	65329, 148692
Merlin Gerin	NC100H	1-3	90850
Merlin Gerin	NC100L	1-4	90850
Merlin Gerin	NC100L MA	3	90850
Merlin Gerin	NC100LH	1-4	90850
Merlin Gerin	NC100N	1-4	90850
Merlin Gerin	NC125H	1-3	90850
Proteus	C6	1	90844
Proteus	AC22BS5419	2	66321, 148702
Proteus	BSEN60947-3	2	66321, 148702
Proteus	C16	1	90844
Proteus	C6	1-3	90844
Siemens 17U	5SQ16	4	90853
Siemens C10	5SX1	1	90850, 149514
Siemens C32	5SX1-2	2	90853, 149514
Siemens ITE	5SN22	2	90853
Siemens ITE	5SQ11	1	90850, 149514
Siemens ITE	5SQ12	2	90853, 149514
Siemens ITE	5SQ13	3	90853, 149514
Siemens ITE	5SQ16	4	90853, 149514
Siemens ITE	5SX11	1	90850
Siemens ITE	5SX12	2	90853
Siemens ITE	5SX13	3	90853, 149514
Siemens ITE	5SX21	1	90850
Siemens ITE	BL	1	65387, 148689, 65396, 148690, 51252, 148696, 51254
Siemens ITE	BL	2-3	66321, 148702, 51254
Siemens ITE	BLF-GFI	2	66321, 148702, 51254
Siemens ITE	BLH	1	65387, 148689, 65396, 148690, 51254
Siemens ITE	BLH	2-3	66321, 148702, 51254
Siemens ITE	BQ	1	65387, 148689, 65396, 148690, 51254
Siemens ITE	BQ	2-3	66321, 148702, 51254
Siemens ITE	BQCH	1-3	65396, 148690, 51254
Siemens ITE	BQD	1-3	65396, 148690, 51254
Siemens ITE	BQH	1	65387, 148689, 65396, 148690, 51254
Siemens ITE	BQH	2-3	66321, 148702, 51254
Siemens ITE	CED6	2-3	65396, 148690, 51254
Siemens ITE	CFD6	2-3	65397*, 148701*
Siemens ITE	CFD6-ETI	2-3	65397*, 148701*
Siemens ITE	CJ3	3	65397, 148701
Siemens ITE	CJD6	2-3	65397, 148701
Siemens ITE	CJD6-ETI	2-3	65397, 148701
Siemens ITE	CLF	2	65397, 148701
Siemens ITE	CMD6	3	65329, 148692
Siemens ITE	CMD6-ETI	3	65329, 148692
Siemens ITE	CND6	3	65329, 148692
Siemens ITE	CPD6	3	65329, 148692
Siemens ITE	CQD	1-3	65396*, 148690*, 51254
Siemens ITE	E2	1-3	65396, 148690, 51254
Siemens ITE	E4	1-3	65396, 148690, 51254
Siemens ITE	ED	1-3	65396, 148690, 51254
Siemens ITE	ED4	1-3	65396, 148690, 51254
Siemens ITE	ED6	1-3	65396, 148690, 51254
Siemens ITE	ED6-ETI	3	65396, 148690, 51254
Siemens ITE	EE3	3	65396*, 148690*, 51254
Siemens ITE	EH3	3	65396*, 148690*, 51254
Siemens ITE	EQP	4	66321, 148702, 51254
Siemens ITE	ET	3	65396*, 148690*, 51254
Siemens ITE	FD6A	2-3	65397*, 148701*
Siemens ITE	FJ2-B	2-3	65396*, 148690*, 65397*, 148701*
Siemens ITE	FJ3	2	65397, 148701
Siemens ITE	FJ6	2	65397*, 148701*

Brand	Model No.	Poles	Compatible Part #
Siemens ITE	FXD6-ETI	2-3	65397*, 148701*
Siemens ITE	FXD6A	2-3	65397*, 148701*
Siemens ITE	GF	1	65396, 148690, 51254
Siemens ITE	HLB	1	65387, 148689, 65396, 148690, 51254
Siemens ITE	HLB	2-3	66321, 148702, 51254
Siemens ITE	HBQ	1	65387, 148689, 65396, 148690, 51254
Siemens ITE	HBQ	2-3	66321, 148702, 51254
Siemens ITE	HE4	1-3	65396, 148690, 51254
Siemens ITE	HED4	1-3	65396, 148690, 51254
Siemens ITE	HED6	2-3	65396, 148690, 51254
Siemens ITE	HFD6	2-3	65397*, 148701*
Siemens ITE	HFXD6	2-3	65397*, 148701*
Siemens ITE	HHED6	2-3	65396, 148690, 51254
Siemens ITE	HHFD6	2-3	65397*, 148701*
Siemens ITE	HHJD6	2-3	65397, 148701
Siemens ITE	HHJXD6	2-3	65397, 148701
Siemens ITE	HJD6	2-3	65397, 148701
Siemens ITE	HJXD6	2-3	65397, 148701
Siemens ITE	HMD6	2-3	65329, 148692
Siemens ITE	HMXD6	2-3	65329, 148692
Siemens ITE	HIN3	2	65329, 148692
Siemens ITE	HND6	2-3	65329, 148692
Siemens ITE	HINXD6	2-3	65329, 148692
Siemens ITE	HPD6	3	65329, 148692
Siemens ITE	HPXD6	3	65329, 148692
Siemens ITE	HQJ2-H	3	65396, 148690, 51254
Siemens ITE	HQP	1	65387, 148689, 65396, 148690, 51254
Siemens ITE	HQP	2-3	66321, 148702, 51254
Siemens ITE	HQPP	1	65387, 148689, 65396, 148690, 51254
Siemens ITE	HQPP	2-3	66321, 148702, 51254
Siemens ITE	HQPPH	2	66321, 148702, 51254
Siemens ITE	HRD6	3	65329, 148692
Siemens ITE	HRXD6	3	65329, 148692
Siemens ITE	JD2	3	65329, 148692
Siemens ITE	JD6-A	2-3	65397, 148701
Siemens ITE	JJ3	3	65397, 148701
Siemens ITE	JJ6	3	65329, 148692
Siemens ITE	JL3	3	65397, 148701
Siemens ITE	JXD2-A	2-3	65397, 148701
Siemens ITE	JXD6-A	2-3	65329, 148692
Siemens ITE	KM3	3	65329, 148692
Siemens ITE	LL3	3	65397, 148701
Siemens ITE	LL6	3	65329, 148692
Siemens ITE	LXD6-ETI	3	65329, 148692
Siemens ITE	MD6	2-3	65329, 148692
Siemens ITE	MXD6	2-3	65329, 148692
Siemens ITE	MXD6-ETI	2-3	65329, 148692
Siemens ITE	ND6	2-3	65329, 148692
Siemens ITE	NXD6	2-3	65329, 148692
Siemens ITE	PD6	3	65329, 148692
Siemens ITE	PXD6	3	65329, 148692
Siemens ITE	QJ2	2-3	65396*, 148690*, 51254
Siemens ITE	QJ2-H	2-3	65396*, 148690*, 51254
Siemens ITE	QJH2	2-3	65396*, 148690*, 51254
Siemens ITE	QP	1	65387, 148689, 65396, 148690, 51254
Siemens ITE	QP	2-3	66321, 148702, 51254
Siemens ITE	QP1	1	65396, 148690, 51254
Siemens ITE	QPH	1	65387, 148689, 65396, 148690, 51254
Siemens ITE	QPH	2-4	66321, 148702, 51254
Siemens ITE	QPP	1	65387, 148689, 65396, 148690, 51254
Siemens ITE	QPP	2-3	66321, 148702, 51254
Siemens ITE	QPPH	1	65387, 148689, 65396, 148690, 51254
Siemens ITE	QPPH	2-3	66321, 148702, 51254
Siemens ITE	RD6	3	65329, 148692
Siemens ITE	RXD6	3	65329, 148692
Siemens ITE	SCMD6	3	65329, 148692
Siemens ITE	SCND6	3	65329, 148692

Lockout Tagout

*Requires use of a cleat.

Circuit Breaker Lockout Compatibility Guide (continued)

Brand	Model No.	Poles	Compatible Part #
Siemens ITE	SHLD6-A	3	65329, 148692
Siemens ITE	SHMD6	3	65329, 148692
Siemens ITE	SHND6	3	65329, 148692
Siemens ITE	SHPD6	3	65329, 148692
Siemens ITE	SMD6	3	65329, 148692
Siemens ITE	SND6	3	65329, 148692
Siemens ITE	SPD6	3	65329, 148692
Siemens ITE	VF3	3	65396, 148690
Siemens L20A	5SN2-2	2	90853, 149514
Square D	EDB	1-3	65396, 148690, 51254
Square D	EGB	1-3	65396, 148690, 51254
Square D	EH4	1-3	65396, 148690, 51254
Square D	EHB	1-3	65396, 148690, 51254
Square D	EHB	2-3	66321, 148702, 51254
Square D	EJB	1-3	65396, 148690, 51254
Square D	EZ	3	65329, 148692
Square D	FA	1-3	65396*, 148690*
Square D	FAL	1-3	65396*, 148690*
Square D	FC	3	65396*, 148690*
Square D	FCL	2-3	65396*, 148690*
Square D	FDA	2-3	65396, 148690, 51254
Square D	FGA	3	51254
Square D	FH	1-3	65396*, 148690*
Square D	FHL	1-3	65396*, 148690*
Square D	FHL-DC	3	65396*, 148690*
Square D	FHP	3	65396*, 148690*
Square D	FI	3	65396*, 148690*
Square D	FIL	3	65396*, 148690*
Square D	FY	1	65396*, 148690*
Square D	GJL	3	65396*, 148690*
Square D	KA	2-3	65396*, 148690*
Square D	KAL	2-3	65396*, 148690*
Square D	KAP	2-3	65397, 148701
Square D	KC	2-3	65396*, 148690*
Square D	KCL	2-3	65396*, 148690*
Square D	KH	2-3	65396*, 148690*
Square D	KHL	3	65396*, 148690*
Square D	KI	2-3	65396*, 148690*
Square D	KIL	2-3	65396*, 148690*
Square D	L2	3	65329, 148692
Square D	LA	2-3	65397*, 148701*
Square D	LAL	2-3	65397*, 148701*, 65329, 148692
Square D	LAP	3	65397*, 148701*, 65329, 148692
Square D	LC	3	65329, 148692
Square D	LCP	3	65329, 148692
Square D	LH	2-3	65397*, 148701*
Square D	LHL	3	65397*, 148701*, 65329, 148692
Square D	LHP	1-2	65397*, 148701*, 65329, 148692
Square D	LXL	3	65329, 148692
Square D	MA	3	65329, 148692
Square D	MA	2-3	65397*, 148701*
Square D	MAL	3	65329, 148692
Square D	MH	2-3	65329, 148692
Square D	MH	2-3	65397*, 148701*
Square D	MHL	2-3	65329, 148692
Square D	ML-1	3	65397*, 148701*
Square D	ML-3	3	65329, 148692
Square D	MXL	3	65329, 148692

Brand	Model No.	Poles	Compatible Part #
Square D	Q1B	2-3	65396, 148690, 51254
Square D	Q1L	2-3	65396, 148690, 51254
Square D	Q2	2-3	65396*, 148690*
Square D	Q2H	2-3	65396*, 148690*
Square D	Q2L	2-3	65396*, 148690*
Square D	Q2MT	2-3	65396*, 148690*
Square D	Q4	2-3	65397*, 148701*
Square D	Q4L	2-3	65397*, 148701*
Square D	QO	1	51252, 148696
Square D	QO	2-3	65387, 148689, 65396, 148690, 51252, 148696, 51254
Square D	QO-H	2	51252, 148696
Square D	QO-SWN	2-3	65387, 148689, 65396, 148690, 51252, 148696, 51254
Square D	QO-VH	1	51252, 148696
Square D	QO-VH	2-3	65387, 148689, 65396, 148690, 51252, 148696, 51254
Square D	QOB	1	51252, 148696
Square D	QOB	2-3	65387, 148689, 65396, 148690, 51252, 148696, 51254
Square D	QOB-H	2	51252, 148696
Square D	QOB-VH	2-3	66321, 148702
Square D	QOB-VH	1	65387, 148689, 65396, 148690, 51252, 148696, 51254
Square D	QOM1-VH	2	65396, 148690, 51254
Square D	QOM2-VH	2	65396, 148690, 51254
Square D	QOU	1	51252, 148696
Square D	QOU	2-3	65396*, 148690*, 51252, 148696, 51254
Square D	QOU w/tie bar	2-3	66321, 148702, 51254
Square D	QYU	1	51252, 148696
Square D	Y1	1	65397, 148701
Sursum	EA53	3	90847
Sylvania GTE	QC	2	66321, 148702, 51254
Sylvania GTE	Type C	2	66321, 148702, 51254
Thomas & Betts	F Frame	1-3	65396, 148690, 51254
Toshiba	E225B	3	65396*, 148690*
Westinghouse	BA	1-3	65387, 148689, 65396, 148690, 51254
Westinghouse	BA w/tie bar	2-3	66321, 148702
Westinghouse	BAB	1-3	65387, 148689, 65396, 148690, 51254
Westinghouse	BR	1-3	65387, 148689, 65396, 148690, 51254
Westinghouse	BR w/tie bar	2-3	66321, 148702, 51254
Westinghouse	BRH w/tie bar	2-3	66321, 148702
Westinghouse	CA	2	65396*, 148690*
Westinghouse	DA	2-3	65397, 148701
Westinghouse	DK	3	65397, 148701
Westinghouse	EB	1-3	65396*, 148690*, 51254
Westinghouse	ED	2-3	65396, 148690, 51254
Westinghouse	EH	1-3	65396, 148690, 51254
Westinghouse	EHB	1-3	65396*, 148690*
Westinghouse	EHD	1-3	65396, 148690, 51254
Westinghouse	FA	3	65396*, 148690*, 51254
Westinghouse	FB	2-3	65396*, 148690*, 51254
Westinghouse	FD	1-4	65396, 148690, 51254
Westinghouse	FDB	2-4	65396, 148690, 51254

Brand	Model No.	Poles	Compatible Part #
Westinghouse	FDC	2-4	65396, 148690, 51254
Westinghouse	FP	3	65397*, 148701*
Westinghouse	GB	1-3	65396, 148690, 51254
Westinghouse	GBH	1-3	65396, 148690, 51254
Westinghouse	GHB	1-3	65396, 148690, 51254
Westinghouse	GR	3	65397, 148701
Westinghouse	HBAW	1	65387, 148689, 65396, 148690, 51254
Westinghouse	HBAX	1	65387, 148689, 65396, 148690, 51254
Westinghouse	HCA	3	65396*, 148690*
Westinghouse	HFB	1-3	65396*, 148690*
Westinghouse	HFD	1-4	65396, 148690, 51254
Westinghouse	HKD	3	65397, 148701
Westinghouse	HLA	3	65397, 148701
Westinghouse	HLB	2-3	65397, 148701
Westinghouse	HMC	3	65397, 148701
Westinghouse	HMCP	3	65396*, 148690*, 51254
Westinghouse	HNC	3	65329, 148692
Westinghouse	HQNP	3	65396, 148690, 51254
Westinghouse	HQP	1	65387, 148689, 65396, 148690, 51254
Westinghouse	JA	2-3	65397, 148701
Westinghouse	JB	3	65397, 148701
Westinghouse	JDB	2-4	65397, 148701
Westinghouse	JDB	3	65397, 148701
Westinghouse	KA	3	65397*, 148701*
Westinghouse	KB	2-3	65397, 148701
Westinghouse	LA	3	65397*, 148701*
Westinghouse	LB	3	65397, 148701
Westinghouse	LBB	3	65397, 148701
Westinghouse	LH	3	65397, 148701
Westinghouse	MA	2-3	65397*, 148701*
Westinghouse	MC	2-3	65397*, 148701*
Westinghouse	MCC	2-3	65397*, 148701*
Westinghouse	MPCO	3	65396*, 148690*, 51254
Westinghouse	NB	2-3	65329, 148692
Westinghouse	P	3	65396, 148690, 51254
Westinghouse	QBHW	1	65387, 148689, 65396, 148690, 51254
Westinghouse	QC	3	66321, 148702
Westinghouse	QC	1	65387, 148689, 65396, 148690, 51254
Westinghouse	QCHQ	1	65387, 148689, 65396, 148690, 51254
Westinghouse	QHCW	1	65387, 148689, 65396, 148690, 51254
Westinghouse	QHCX	1	65387, 148689, 65396, 148690, 51254
Westinghouse	QHPW	1	65387, 148689, 65396, 148690, 51254
Westinghouse	QPHW	1	65387, 148689, 65396, 148690, 51254
Westinghouse	Quicktag P	1-3	65396, 148690, 51254
Westinghouse	RE	1-2	65396, 148690, 51254
Westinghouse	RH	3	65397, 148701
Westinghouse	WPHX	1	65387, 148689, 65396, 148690, 51254
Wylex	WRS40/2	2	90844
Zinsco	HQB	3	65396, 148690, 51254
Zinsco	QB	1	65396, 148690, 51254

Lockout Tagout

Standard Circuit Breaker Lockouts



- 65387 148689**
120V Snap-on lockout
- 65396 148690**
120/277V Clamp-on lockout
- 65397 148701**
480/600V Clamp-on lockout
- 65329 148692**
480/600V Oversized lockout
- 66321 148702**
Universal multi-pole lockout

EZ Paneloc™ Lockouts



- 51252 148696**
Snap-on (SQD QO) lockout
- 51254**
Clamp-on (universal) lockout

Miniature Circuit Breaker Lockouts



- 90844**
Pin-out standard lockout
- 90847**
Pin-in standard lockout
- 90850**
Pin-out wide lockout
- 90853**
Tie-bar lockout
- 149433**
Rotary lockout
- 149514**
Universal lockout

*Requires use of a cleat.

Circuit Breaker Lockouts

BradyID.com/s36

TAGLOCK™ Circuit Breaker Securing Devices

Tagout plus physical restraint protection for multiple workers

With TAGLOCK™ circuit breaker securing devices from Brady, your maintenance team members can individually tag and secure each circuit breaker for improved safety and compliance. These devices are secured to circuit breakers with standard non-releasable 50-pound minimum strength nylon cable ties and meet OSHA requirement 1910.269(d)(3)(ii)(D) for power generation, transmission and distribution facilities.

TAGLOCK securing devices feature:

- **Easy installation** onto the breaker with nylon cable tie and the worker's ID tag
- **Multiple worker tagging capabilities** for up to 4 workers to apply a nylon cable tie and their ID tag
- **Secure restraints** that will remain securely fastened to the breaker switch until each person has removed their nylon cable tie and tag
- **Pre-loadable tags** enable users to prepare ID tags in advance and then quickly secure them to the designated energy control lockout points
- **More convenient** lockout tagout option eliminates the need to use locks
- **Cost savings** from less tag preparation and reduced equipment downtime



Lockout Tagout



Securable by BOTH cable tie and safety lock at the same time



Save time by "pre-loading" your tag and cable tie before walking to the energy point



120V breaker lockout devices fit on breakers next to each other, enabling multiple tagouts at one time



Pair your TAGLOCK devices with Mini Lockout Tags

Catalog #	Description	Size	Qty.
148824	Mini Lockout Tags (Fasteners sold separately)	2.5 in. x 2 in.	25
81762	Nylon Fasteners	7 in.	100



TAGLOCK™ 120V Snap-On Breaker Lockout

- Designed for 120V breakers with holes in the switch tongue
- Quick and easy – just snap in place and apply lock
- Dual cavities accommodate different size switch tongues
- Single and 6 packs include cable ties

Catalog #	Description	Qty
148689	120V Snap-On Breaker Lockout	1
148693	120V Snap-On Breaker Lockout	6
148694	120V Snap-On Breaker Lockout (Cable ties sold separately)	50



TAGLOCK™ 120V Holed-Tongue Breaker Lockout

- Align pins with holes in breaker and snap closed
- Pins prevent switch from being thrown
- Lockout is small enough to lockout multiple breakers in a row
- Single and 6 packs include cable ties

Catalog #	Description	Qty
148696	Breaker Switches with Holes	1
148688	Breaker Switches with Holes	6
148700	Breaker Switches with Holes (Cable ties sold separately)	50

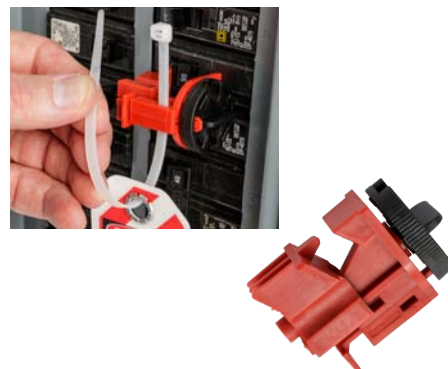

TAGLOCK™ Universal Multi-Pole Breaker Lockout

- Single device works with most major multi-pole breakers that employ a tie-bar
- Use thumbscrew to clamp lockout securely over tie bar, then insert lock to prevent clamp from being loosened
- Single and 6 packs include cable ties

Catalog #	Description	Qty
148702	Multi-pole Breaker Lockout	1
148697	Multi-pole Breaker Lockout	6
148695	Multi-pole Breaker Lockout (Cable ties sold separately)	50



TAGLOCK™ 120/277V Clamp-On Breaker Lockout

- Works on a wide range of single-pole and internal-trip multi-pole breakers
- Use thumbscrew to clamp lockout onto switch tongue, then pull cover over thumbscrew and lock in place
- Includes cleat to expand the range of applicable breakers
- Single and 6 packs include cable ties

Catalog #	Description	Qty
148690	120/277V Breaker Lockout	1
148698	120/277V Breaker Lockout	6
148699	120/277V Breaker Lockout (Cleats and cable ties sold separately)	50
65404	Extra Cleats for 120/277V Lockout	6

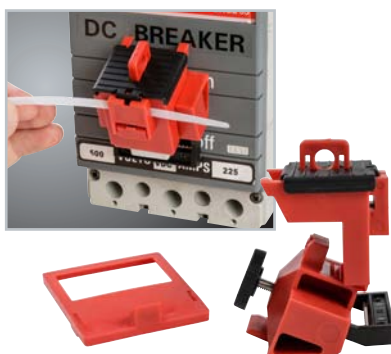

TAGLOCK™ 480/600V Clamp-On Breaker Lockout

- Works on a wide range of single-pole and internal-trip multi-pole breakers
- Use thumbscrew to clamp lockout onto switch tongue, then pull cover over thumbscrew and lock in place
- Includes cleat to expand the range of applicable breakers
- Single and 6 packs include cable ties

Catalog #	Description	Qty
148701	480/600V Breaker Lockout	1
148687	480/600V Breaker Lockout	6
148686	480/600V Breaker Lockout (Cleats and cable ties sold separately)	25
65406	Extra Cleats for 480/600V Lockout	6



TAGLOCK™ Oversized Clamp-On Breaker Lockout

- Oversized 480/600V frame lockout fits breaker switches up to 2.25 in. wide and 0.875 in. thick
- Made of durable polypropylene and glass filled-impact-modified nylon
- Single and 6 packs include cable ties

Catalog #	Description	Qty
148692	Oversized Breaker Lockout	1
148691	Oversized Breaker Lockout	6
148685	Oversized Breaker Lockout (Cable ties sold separately)	25

Circuit Breaker Lockouts

BradyID.com/s36

EZ Paneloc™ System

- Works on wide range of breakers, including single- and multi-pole configurations
- Can be used with most padlocks by making use of unique lock rail system
- Allows panel door to be closed even when lockouts are in place
- Accommodates multiple locks, facilitating group lockout activity without hasps
- Keeps weight off the breakers, protecting delicate electrical components
- Positions locks and tags outside the panel, making sure lockout activity is clearly visible to anyone in the area

(Not recommended for use with multi-lock hasps)



Snap-On Lockout

- For use on Square D NQO and other breakers with a hole in the switch tongue
- Align pins with holes in breaker and snap closed
- Pins prevent switch from being thrown
- Size: 0.90 in. x 1.88 in. x 0.74 in.
- Rails sold separately

Catalog #	Description	Qty.
51252	Snap-On Lockout w/ 2 in. Cable	1
65815	Snap-On Lockout w/ 2 in. Cable	6



Clamp-On Lockout

- For use on breakers that do not have a hole in the switch tongue
- Turn thumbscrew to clamp lockout securely onto switch, then snap the cover closed to prevent thumbwheel from being loosened
- Size: 0.95 in. x 2.56 in. x 0.74 in.
- Rails sold separately

Catalog #	Description	Qty.
51254	Clamp-On Lockout w/ 2 in. Cable	1
65810	Clamp-On Lockout w/ 2 in. Cable	6



Spacing Gasket and Lock Rails

- For low profile panels
- Self-adhesive gasket pushes out low profile panel frame adding an additional 0.375 in. of clearance between the panel and the door
- Lock rails made of durable isoplast polymers with acrylic adhesive backing

Catalog #	Description	Qty.
51256	4 in. Lock Rail (7 loops)	1
65814	4 in. Lock Rail (7 loops)	6
51258	8 in. Lock Rail (15 loops)	1
51260	8 in. Lock Rail (15 loops)	6
89256	Spacing Gasket 0.375 in. x 1 in. x 15 ft.	1

Lockout Tagout

EZ Paneloc System In Action



1. Expose the super-bond adhesive on back of rail. Permanently affix to any location on the panel.



2. Attach the lockout device to the breaker and snap into locked position.



3. Pass plastic key through lock rail and attach lock, preventing key from sliding down cable to device.



4. After procedure is finished, unlock device by inserting and turning the black plastic key.

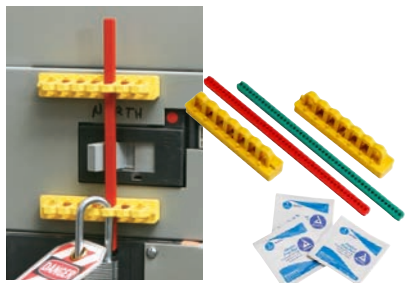

480-600V Breaker Blocker

- For oversized and irregularly shaped switches
- Self-adhesive backed rails are permanently installed onto panel
- Blocking bars are 7.6 in. long
- Red blocking bar indicates locked off, green bar indicates locked on

Catalog #	Description	Qty.
90891	Breaker Block Kit*	1
90892	7.6 in. Red Blocking Bar	5
90893	7.6 in. Green Blocking Bar	5
51264	4 in. Yellow Mounting Rails	2
51265	Blocking Bar Holder	5

*Kit includes 2 yellow mounting rails, 1 red blocking bar, 1 green blocking bar and 3 alcohol wipes.



120/277V and 480/600V Clamp-On Breaker Lockout

- Works on a wide range of single-pole and internal-trip multi-pole breakers
- Use thumbscrew to clamp lockout onto switch tongue, then pull cover over thumbscrew and lock in place
- Accepts lock shackles up to 0.28 in.
- Detachable cleats expand the range of applicable breakers

Catalog #	Description	Qty.
65396	120/277V Clamp-On w/ Cleat	1
65965	120/277V Clamp-On w/ Cleat	6
65397	480/600V Clamp-On w/ Cleat	1
65966	480/600V Clamp-On w/ Cleat	6



Universal Multi-Pole Breaker Lockout

- Single device works with most major multi-pole breakers that employ a tie-bar
- Made of durable impact-modified nylon
- Use thumbscrew to clamp lockout securely over tie bar, then insert lock to prevent clamp from being loosened

Catalog #	Description	Qty.
66321	Universal Multi-Pole Breaker Lockout	1
66320	Universal Multi-Pole Breaker Lockouts	6



Oversized 480/600V Clamp-On Breaker Lockout

- Oversized 480/600V frame lockout fits breaker switches up to 2.25 in. wide and 0.875 in. thick
- Made of durable polypropylene and glass-filled, impact-modified nylon

Catalog #	Description	Qty.
65329	Oversized Breaker Lockout	1
65321	Oversized Breaker Lockout	6

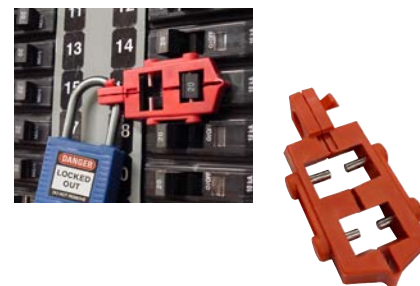

120V Snap-On Breaker Lockout

- Designed for 120V breakers with holes in the switch tongue
- Quick and easy – just snap in place and apply lock
- Dual cavities accommodate different size switch tongues
- Accepts lock shackles up to 0.28 in. dia.
- Dimensions: 0.83 in. x 0.35 in. x 2.15 in.

Catalog #	Description	Qty.
65387	120V Snap-On Breaker Lockout	1
65688	120V Snap-On Breaker Lockouts	6

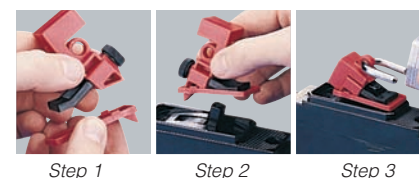

Step 1

Step 2

Step 3



Extra Cleats for Clamp-On Breaker Lockout

- Use in conjunction with clamp-on breaker lockouts (sold separately) to expand the range of applicable breakers that can be locked out
- Easily clips onto the bottom of the lockout body
- Assures positive restraint for breakers with long, sliding switch throws

Catalog #	Description	Qty.
65404	Extra Cleats For 120/277V Lockout	6
65406	Extra Cleats For 480/600V Lockout	6

Circuit Breaker Lockouts

BradyID.com/s36

Miniature circuit breaker lockouts for single- and multi-pole breakers

The Miniature Circuit Breaker Lockout Devices from Brady are designed with specific circuit breakers in mind so that lockout can be completed safely and effectively without any tools. These lockouts feature quick and easy installation. Color tips to easily differentiate between devices.



Universal Fit

- One lockout device fits numerous ABB, Hager, Siemens and Schneider mini-circuit breakers
- Low-profile design allows for panel door closure
- Accept locks with shackle diameter up to 0.28 in.
- Quick and easy installation with no tools required
- Works on both single- and multi-pole breakers
- Made from durable, fiberglass reinforced nylon

Catalog #	Type	Qty.
149514	Miniature circuit breaker lockout - Universal Fit (UF)	1
149515	Miniature circuit breaker lockout - Universal Fit (UF)	6

ABB MS325

- Specifically designed to lockout ABB MS325 series breakers
- Easy one-handed push button installation
- Complete lockout with full size padlock
- Extra-wide tip for added lockout security
- Made from durable, fiberglass reinforced nylon

Catalog #	Type	Qty.
149433	Miniature circuit breaker lockout - ABB MS325 (MS)	1
149434	Miniature circuit breaker lockout - ABB MS325 (MS)	6

Lockout Tagout

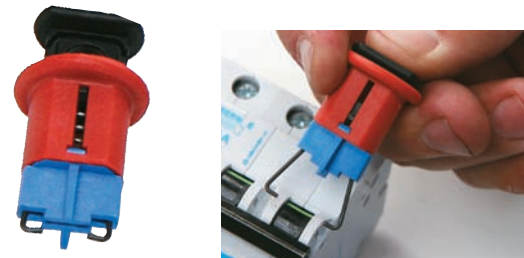

Pin-Out Standard (POS)

- Easily installed with a push button; no tools required
- Accept locks with shackle diameter up to 0.28 in.
- Works on both single- and multi-pole breakers
- Made from durable, fiberglass reinforced nylon

Catalog #	Type	Qty.
90844	Miniature circuit breaker lockout - Pin-Out Standard (POS)	1
90845	Miniature circuit breaker lockout - Pin-Out Standard (POS)	6

Pin-In Standard (PIS)

- Easily installed with a push button; no tools required
- Accept locks with shackle diameter up to 0.28 in.
- Works on both single- and multi-pole breakers
- Made from durable, fiberglass reinforced nylon

Catalog #	Type	Qty.
90847	Miniature circuit breaker lockout - Pin-In Standard (POS)	1
90848	Miniature circuit breaker lockout - Pin-In Standard (POS)	6

Miniature circuit breaker compatibility chart

Brand	Poles	Model No.	Type	Catalog # (1/pkg)
ABB	1	S222	POS, UF	90844, 149514
ABB	1	F374	POS, UF	90844, 149514
ABB	1	S251, S261, S263	POS, UF	90844, 149514
ABB	1	S272, S253	POS, UF	90844, 149514
ABB	3	S253	POS, UF	90844, 149514
ABB	3	MS325	MS, UF	149433, 149514
AEG	2	E82S	PIS	90847
Allen-Bradley	1,2,3	1492-CB1, 2, 3	POS	90844
Buschmat	1	S46	POS	90844
Clipsal	1	4CB116	POS	90844
Clipsal	3	4CB320	POS	90844
E-TA	1	911225	PIS	90847
E-TA	2	911220G	POS	90844
FAZ	4	C16	POS	90844
FAZ	1	C16	POS	90844
GE Vynckier	3	Series E	PIS	90847
GE Vynckier	3	Series G	PIS	90847
GE Vynckier	4	Series E	PIS	90847
GE Vynckier	1	Series G	PIS	90847
GE Vynckier 16A	2	Series E	PIS	90847
GE Vynckier C16, 16A	1	Series E	PIS	90847
Hager	3	453717	POS, UF	90844, 149514
Hager	2	MW216A	POS, UF	90844, 149514
Hager	4	MW620A	POS, UF	90844, 149514
Kapp	1	LS68	PIS	90844
Legrand	2	1935	TBLO	90844

Brand	Poles	Model No.	Type	Catalog # (1/pkg)
Legrand	3	1980	TBLO	90844
Legrand	4	1980	TBLO	90844
Legrand	2	4302	PIS	90847
Legrand	3	6469	PIS	90847
Legrand	1	1908	PO	90844
Merlin Gerin	3	C80A	TBLO, POW	90850, 90853
Merlin Gerin	2	B100A	TBLO, POW	90850, 90853
Merlin Gerin	1	C60N	POS	90844
Merlin Gerin	1	C32N	POS	90844
Merlin Gerin	2	C60N	POS	90844
Merlin Gerin	4	C60N	POS	90844
Merlin Gerin	3	C32N	POS	90844
Merlin Gerin	3	C45AD	POS	90844
Proteus	1	C16	POS	90844
Proteus	1	C6	POS	90844
Proteus	3	C6	POS	90844
Siemens 17U	2	5SQ12	TBLO, UF	90853, 149514
Siemens 17U	3	5SQ13	TBLO, UF	90853, 149514
Siemens 17U	4	5SQ16	TBLO, UF	90853, 149514
Siemens 17U	1	5SQ11	POW, UF	90850, 149514
Siemens C10	1	5SX1	POW, UF	90850, 149514
Siemens C32	2	5SX1-2	TBLO, UF	90853, 149514
Siemens C70	3	5SX13	TBLO, UF	90853, 149514
Siemens L20A	2	5SN2-2	TBLO, UF	90853, 149514
Sursum	3	EA53	PIS	90847
Wylex	2	WRS40/2	POS	90844

Lockout Tagout

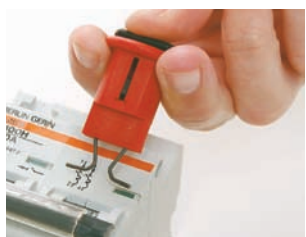

Pin-Out Wide (POW)

- Easily installed with a push button; no tools required
- Accept locks with shackle diameter up to 0.28 in.
- Works on both single- and multi-pole breakers
- Made from durable, fiberglass reinforced nylon

Catalog #	Type	Qty.
90850	Miniature circuit breaker lockout - Pin-Out Wide (POW)	1
90851	Miniature circuit breaker lockout - Pin-Out Wide (POW)	6

Tie-Bar Lockout (TBLO)

- Thumb wheel for quick application, no tools required
- Accept locks with shackle diameter up to 0.28 in.
- Works on both single- and multi-pole breakers
- Made from durable, fiberglass reinforced nylon

Catalog #	Type	Qty.
90853	Miniature circuit breaker lockout - Tie-Bar Lockout (TBLO)	1
90854	Miniature circuit breaker lockout - Tie-Bar Lockout (TBLO)	6

Fuse and Terminal Block Lockouts

BradyID.com/s36

new

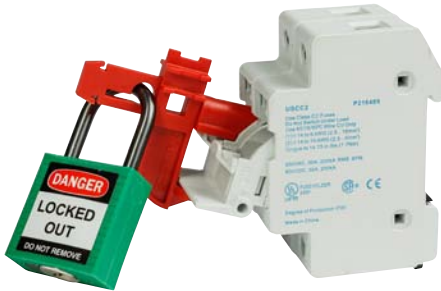

Fuse and Terminal Block Lockouts

- Designed for quick and easy installation with no tools needed
- Durable and non-conductive
- Made from fiberglass reinforced nylon
- Accepts 0.25 in. shackle safety padlocks, compact safety padlocks, cable padlocks and nylon ties



0.56 in. Block Fuse Lockout

Catalog #	Fits	Qty.
149280	0.56 in. Fuse Blocks	2
149281	0.56 in. Fuse Blocks	50

USSC2 Modular Fuse Lockout

Catalog #	Fits	Qty.
149282	USSC2 Modular Blocks	2
149283	USSC2 Modular Blocks	50

GE NEC Fuse Lockout

Catalog #	Fits	Qty.
149284	GE, NEC Fuse Blocks	2
149285	GE, NEC Fuse Blocks	50

Terminal Block Lockout

Catalog #	Fits	Qty.
149278	Multiple Terminal Blocks	2
149279	Multiple Terminal Blocks	50

Lockout Tagout



Universal Fuse Lockout

- Designed to prevent the unintended re-energization of an energy source through a fuse
- Easy to use device fits most fuse holders between 20 and 400 amps
- Dimensions: 1.38 in. x 0.59 in. x 2.36 in.

Catalog #	Description	Qty.
873367	Universal Fuse Lockout - Red	1

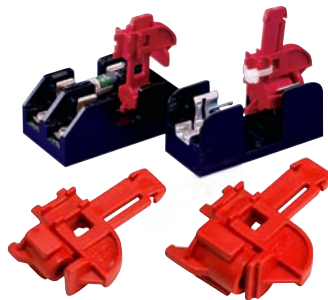

Fuse Lockout Device

- Unique locking mechanism prevents device from being accidentally removed from fuse block
- Available in two sizes for most commonly used fuses

Catalog #	Description	Qty.
65750	Fuse Lockout size 13/32 in.	6
65751	Fuse Lockout size 9/16 in.	6

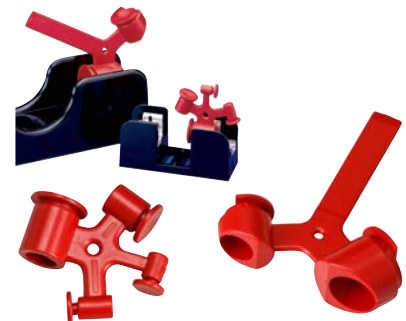

Fuse Blockout Device

- Small blockout device fits fuses 0.25, 0.28, 0.41 and 0.56 in. sizes
- Large blockout to fits 0.68 in., 0.81 in. and blade type fuses

Catalog #	Description	Qty.
65690	Small Fuse Blockout	6
65691	Large Fuse Blockout	6



Safe-T-Grip® Fuse Pullers

- Provides maximum convenience when removing or replacing cartridge fuses
- Notched handles for non-slip grip
- Clearly marked amperage ranges
- Exceeds MIL specifications

Catalog #	Description	Application
65279	5 in. Fuse Puller	For 9/32 in. to 1/2 in. dia. fuses
65280	7.5 in. Fuse Puller	For 0-100A, 250V and 600V



Pneumatic Quick-Disconnect Lockout

- Isolates pneumatic energy without the expense and inconvenience of installing in-line lockout valves
- Device is applied to the male fitting, isolating equipment from all compressed air sources
- Accommodates the majority of 0.25 in., 0.375 in., 0.5 in. male fittings
- Hole in center of device allows for permanent storage on an air hose and a loop on the side can be used to hang the hose and lockout device
- Accepts up to 0.25 in. shackle

Catalog #	Description	Qty.
64221	Pneumatic Lockout	1
65645	Pneumatic Lockout	6

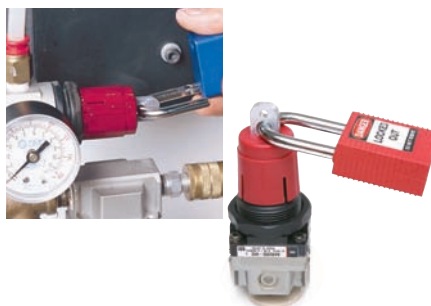

SMC Air Line Regulator Lockout

- Enables regulator to be locked in the on, off or throttled position
- Easy installation: remove snap cap, install lockout on regulator rod, snap replacement cap on regulator
- Comes with lockout, cap and allen wrench. Padlock not included.

Catalog #	Description
64539	Lockout for Miniature SMC Models AR2000 / NAR2000
64540	Lockout for Intermediate SMC Models AR3000 / NAR3000



Cylinder Tank Lockout

- Used to lockout cylinder tanks, including propane tanks on fork trucks and stand alone propane tanks
- Apply with ease to prevent access to the valve handle
- Designed to fit in tight spaces
- Valve stem hole is 1.25 in. diameter
- Made of rugged polystyrene plastic

Catalog #	Description
SD02M	Cylinder Tank Lockout



Gas Cylinder Lockout

- Prevents access to main cylinder valve
- No need to match your lockout device to varying diameters and threads of cylinder caps
- Accommodates neck rings up to 3.5 in. diameter
- Easy and efficient installation

Catalog #	Description	Qty.
LM023E	Gas Cylinder Lockout	1



Snap Cap™ Gas Cylinder Lockout

- Designed to fit most North American pressure gas cylinders
- Meets DOT standards Denies access to the main cylinder control and regulator attachment
- Powder-coated welded steel construction is extremely durable

Catalog #	Size	Thread Type
90496	6.5 in. x 3.125 in. x 11 UN	High Pressure Fine Thread
95137	6.5 in. x 3.5 in. x 11 UN	Low Pressure Fine Thread
95138	6.5 in. x 3.125 in. x 11 UN	High Pressure Coarse Thread
95139	6.5 in. x 3.5 in. x 11 UN	Low Pressure Coarse Thread

Safety Covers

BradyID.com/s36



new

Pendant Control Safety Cover

- Innovatively designed device controls access to your pendant controls
- Rigid sides prevent access on all four sides to prevent access to buttons
- Expandable for use on multiple-sized pendants up to 18 inches
- Collapsible design for easy transport and storage – simply flatten, store or take wherever need
- Room for up to four padlocks

Catalog #	Description	Size	Qty.
150587	Pendant Control Safety Cover	5.25 in W x 11 in L (Expands to fit 18 in pendant)	1



Lockout Tagout



Push Button and E-Stop Safety Covers

- Temporarily prevent access to the ON/OFF and emergency stop buttons
- Universal fit for IEC and NEMA buttons
- Features one-time installation of low profile base and removable, transparent cover which allows view of button position while cover is installed
- Hinged eyelet accepts safety locks
- Each base supplied with 1 yellow label, 1 red label and adhesive backing



Each base supplied with 1 yellow label, 1 red label and adhesive backing

Catalog #	Description	Button	Color	Qty.
134018	Small Base with Short Cover	16mm	Red Cover	1
130819	Small Base with Tall Cover	16mm	Red Cover	1
130820	Medium Base with Medium Cover	22mm	Red Cover	1
130821	Large Base with Medium Cover	30mm	Red Cover	1
139793	Small Base with Short Cover	16mm	Clear Cover	1
139794	Small Base with Tall Cover	16mm	Clear Cover	1
139795	Medium Base with Medium Cover	22mm	Clear Cover	1
139796	Large Base with Medium Cover	30mm	Clear Cover	1
130822	Extra Bases - Small	16mm	Clear	5
130823	Extra Bases - Medium	22mm	Clear	5
130824	Extra Bases - Large	30mm	Clear	5



Wall Switch Lockouts

- Use with most wall-mounted switches
- Easy to install using existing screws
- Come in a high visibility red color and can lock switch in ON or OFF position

Catalog #	Description	Qty.
65392	Red Wall Switch Lockout	1
65696	Red Wall Switch Lockout	6



Clear Wall Switch Lockout

- Use with most wall-mounted switches
- Easy to install using existing screws
- Features a patented non-hinge design and is made of strong, clear polycarbonate

Catalog #	Description	Qty.
WSLO	Clear Wall Switch Lockout	1

*Padlock not included



Push Button Cover
NEMA 30.5 mm (PBL6)



Push Button Cover
IEC 22.5mm (PBL8)

Push Button Safety Covers

- 104602: Clear hinged cover completely covers button, and prevents access. White legend plate included
- 104603: Clear and metal hinged cover completely covers button preventing access

Catalog #	Type	Qty
PBL6	Push Button Safety Cover - NEMA 30.5 mm	1
PBL8	Push Button Safety Cover - IEC 22.5 mm	1



Emergency Stop Cover
NEMA 30.5mm (PBL2)



Emergency Stop Cover
IEC 22.5mm (PBL4)

Emergency Stop Safety Covers

- Permanently install over push / pull or twist-release emergency stops
- Durable metal bar locks button in the depressed OFF position when lock shackle is inserted

Catalog #	Type	Qty
PBL2	Emergency Stop Cover - NEMA 30.5 mm	1
PBL4	Emergency Stop Cover - IEC 22.5 mm	1

Plug Lockouts

BradyID.com/s36



Internal post prevents cable from slipping or being pulled out



Large size fits terminal end and inline connectors



Single device fits connectors with and without handles



Non-conductive pins ensure the device stays tightly in place

BatteryBlock™ Battery Cable Lockout for Commercial Vehicles

- Innovatively designed device keeps battery cables locked out throughout vehicle maintenance
- Non-conductive post and cover prevent the cable from slipping or being pulled out of the device
- Low-profile design for tight working areas
- Space for up to two padlocks so your device stays secured throughout maintenance
- Large size fits terminal end and inline connectors

Catalog #	Type	Qty
150820	BatteryBlock for Commercial Vehicles - Small	1
150822	BatteryBlock for Commercial Vehicles - Small	24
150821	BatteryBlock for Commercial Vehicles - Large	1
150823	BatteryBlock for Commercial Vehicles - Large	24

BatteryBlock™ Power Connector Lockout for Forklifts

- Innovatively designed device securely locks out forklift power connector during maintenance
- Unlike current products on the market, this device fits on 175A and 350A power connectors with and without handles
- Single-piece design with space for two padlocks
- Non-conductive pins ensure the device stays tightly in place during off-shift periods or maintenance projects

Catalog #	Type	Qty
150841	BatteryBlock for Forklifts	1

Lockout Tagout



3-In-1 Electrical Plug Lockout

- Accommodates high- and low-voltage plugs up to 3 in. diameter and 5.5 in. long
- Sliding top lids can be used individually or together to accommodate small, medium and large-diameter cords
- Constructed of yellow thermoplastic and supplied with bilingual label

Catalog #	Type	Qty
PL023	3-in-1 Plug Lockout	1



Electrical Plug Lockouts

- Rugged polypropylene lockout prevents electrical plugs from being inserted into a wall outlet
- Use when plug will not remain under the exclusive acontrol of the person performing service
- Small: 2 in. x 2 in. x 3.5 in. with 0.5 in. dia. hole for cable
- Large: 3.25 in. x 3.25 in. x 7 in. with 1 in. dia. hole for cable

Catalog #	Type	Qty
65674	Small 110V Plugout	1
65675	Large 220/500V Plugout	1

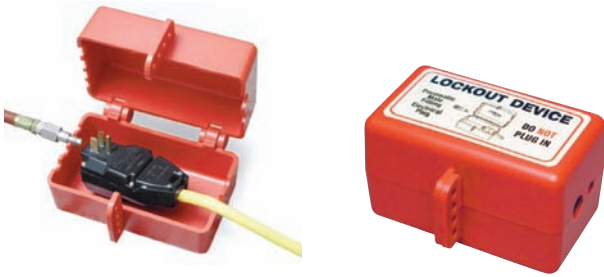

Electrical / Pneumatic Plug Lockout

- Accommodates a large variety of electrical plugs up to 3.5 in. diameter and 5 in. long as well as male air hose connectors
- Holes accommodate electrical cord or necked down pneumatic male fittings commonly attached to compressed air hose
- Works on 110V, 220V and 550V plugs
- Constructed of durable polystyrene

Catalog #	Type	Qty
PLO27E	Electrical/Pneumatic Plug Lockout	1



Hubbell Plugout™ Lockout

- Two sizes available to fit most heavy industrial plug applications
- Small dimensions: 4.25 in. x 7.31 in. maximum cord dia. 1.2 in. max plug size 2.75 in x 4.75 in
- Large dimensions: 6.31 in. x 12.47 in. maximum cord dia. 1.46 in. max plug size 4.5 in x 10.3 in

Catalog #	Type	Qty
65695	Small Hubbell Plugout Lockout	1
65968	Large Hubbell Plugout Lockout	1

Lockout Tagout



Stoppower® Plug Lockouts

- Ideal for office equipment and other frequently locked out cords
- For use on 2 or 3 pronged polarized plugs
- Cord cannot be plugged in with Stoppower in place
- Device cannot be removed without key

Catalog #	Type	Qty.
65673	Red Stoppower Plug (keyed different)	1
QB0033	Red Stoppower Plug (keyed alike)	1



Detachable IEC Plug Lockout

- Block to prevent power going to the socket
- Durable, vibrant-orange nylon material
- Lightweight, compact size
- Simply plug into socket and twist

Catalog #	Type	Qty.
148081	Detachable IEC Lockout	1

*Padlock not included



AC Sensor

- Selected by OSHA Electrical Technical Equipment Committee as the only instrument of its type for use by OSHA compliance officers to identify and cite electrical hazards of 50-1000 volts AC
- CAT IV rated and UL Listed

Catalog #	Description	Qty.
65269	AC Sensor	1

Combination Lockout Kits

BradyID.com/s36

Electrical / Valve Combination Lockout Kits

These combination lockout kits can be purchased with or without padlocks and tags. Padlocks included in these kits are keyed differently (each lock has its own unique key). For kits keyed alike, see the Personal Lockout Kits.



Combination Lockout Satchel

- Everything you need to lock out the most common mechanical and electrical control points, with extra valve lockout devices
- Components:
 - 1 - Large Univ. Valve Lockout w/ Blocking Arm (50899 and 65403)
 - 1 - All-Purpose Cable Lockout w/ 8 ft. Sheathed Cable (50943)
 - 1 - 0.25 in. to 1 in. Ball Valve Lockout (65666)
 - 1 - 1 in. to 2.5 in. Gate Valve Lockout (65560)
 - 1 - 2.5 in. to 5 in. Gate Valve Lockout (65561)
 - 1 - 5 in. to 6.5 in. Gate Valve Lockout (65562)
 - 1 - 120V Snap-On Breaker Lockout (65387)
 - 1 - 120 / 277V Clamp-On Breaker Lockout w/ Cleat (65396)
 - 1 - 480 / 600V Clamp-On Breaker Lockout w/ Cleat (65397)
 - 1 - Universal Multi-pole Breaker Lockout (66321)
 - 1 - 110V Electrical Plug Lockout (65674)
 - 1 - Wall Switch Lockout (65392)
 - 1 - Lockout Satchel (51173)
 - Optional:
 - 2 - Keyed-different Padlocks
 - 2 - Heavy-duty Lockout Tags w/ Cable Ties (65520)

Catalog #	Description
99687	Kit w/ 2 Nylon Padlocks and 2 Tags
99688	Kit w/ 2 Steel Padlocks and 2 Tags
99686	Kit without padlocks



Combination Lockout Toolbox

- Contains all of the basic tools needed to lock out gate and ball valves, circuit breakers, switches and plugs
- Components:
 - 1 - 1 in. to 6.5 in. Adjustable Gate Valve Lockout (64057)
 - 1 - 0.25 in. to 1 in. Ball Valve Lockout (65666)
 - 1 - 1.25 in. to 3 in. Ball Valve Lockout (65669)
 - 1 - 120V Snap-On Breaker Lockout (65387)
 - 1 - 120 / 277V Clamp-On Breaker Lockout w/ Cleat (65396)
 - 1 - 480 / 600V Clamp-On Breaker Lockout w/ Cleat (65397)
 - 1 - Universal Multi-pole Breaker Lockout (66321)
 - 1 - 110V Electrical Plug Lockout (65674)
 - 1 - Wall Switch Lockout (65392)
 - 1 - Lockout Belt Pouch (51172)
 - 1 - Extra-Large Lockout Toolbox (LKP-TKLBOX)
 - Optional:
 - 2 - Keyed-different Padlocks
 - 2 - Heavy-duty Lockout Tags w/ Cable Ties (65520)

Catalog #	Description
99684	Kit w/ 2 Nylon Padlocks and 2 Tags
99685	Kit w/ 2 Steel Padlocks and 2 Tags
99682	Kit without padlocks



SafeKey Padlocks

Maintenance Lockout Kit

- Lockout kit specifically designed for use by internal maintenance crews
- Components:
 - 1 - 0.5 in. to 2.5 in. Small Ball Valve Lockout (BS07A)
 - 1 - 1 in. to 2.5 in. Gate Valve Lockout (65560)
 - 1 - 2.5 in. to 5 in. Gate Valve Lockout (65561)
 - 1 - All-Purpose Cable Lockout (50943)
 - 1 - 3-in-1 Electrical Plug Lockout (PLO23)
 - 1 - Wall Switch Lockout (65392)
 - 2 - 120 / 277V Clamp-On Breaker Lockouts w/ Cleats (65396)
 - 2 - Universal Multi-pole Breaker Lockouts (66321)
 - 1 - 110V Electrical Plug Lockout (65674)
 - 1 - AC Sensor (65269)
 - 10 - Lockout Danger Tags (LT10)
 - 1 - 1 in. Steel Lockout Hasp (T218)
 - 1 - 1.5 in. Steel Lockout Hasp (T220)
 - 1 - Sheet of Lock Labels (LID-2)
 - 1 - Lockout Safety Training Booklet (2112X)
 - 1 - Plastic Utility Box (LKP-TKLBOX)
 - 3 - Keyed-different Padlocks

Catalog #	Description
150952	Kit w/ 3 SafeKey Nylon Padlocks w/ Steel Shackles
150951	Kit w/ 3 SafeKey Aluminum Padlocks
134032	Kit w/ 3 Key-Retaining Steel Padlocks

Lockout Tagout



SafeKey Padlocks

Premium Lockout Kit

- Premium portable lockout kit that contains a large variety of electrical and mechanical lockout devices, tags, and labels
- Components:
 - 2 - Multi-pole Breaker Lockouts (BL07)
 - 3 - Single Pole Breaker Lockouts (BL01)
 - 1 - 1 in. to 2.5 in. Gate Valve Lockout (65560)
 - 1 - 2.5 in. to 5 in. Gate Valve Lockout (65561)
 - 1 - Cable Lockout Device (CABLO)
 - 1 - Wall Switch Lockout (WSLO)
 - 1 - 3-in-1 Electrical Plug Lockout (PLO23)
 - 1 - 120-600 AC Voltage Sensor (ESAC600)
 - 3 - 1.5 in. Steel Lockout Hasps (T220)
 - 5 - Lockout Labels "Lock Out Before Servicing" (LOSV15)
 - 5 - Lockout Labels "Lock Out Here" (LOSV14)
 - 5 - Lockout Labels "Caution This Machine Must Be Locked Out" (LOSV2)
 - 20 - Lockout Tags (LT10)
 - 14 - Padlock Labels (LID-2)
 - 1 - Lockout Safety Training Booklet (2112X)
 - 1 - Extra-Large Lockout Toolbox (LKP-TKLBOX)
 - 3 - Keyed-different Padlocks

Catalog #	Description
LKP-SK-NS	Kit w/ 3 SafeKey Nylon Padlocks w/ Steel Shackles
LKP-SK-AL	Kit w/ 3 SafeKey Aluminum Padlocks
LKP	Kit w/ 3 Key-Retaining Steel Padlocks



Ultimate Lockout Kit

- Ultimate portable lockout kit contains a variety of lockout devices for electrical and mechanical applications
- Components:
 - 1 - Safetee™ Donut 1 in. to 2.5 in. (SD02)
 - 1 - Safetee™ Donut 5 in. to 6.5 in. (SD06)
 - 1 - Ball Valve Lockout (BS07A)
 - 1 - Ball Valve Lockout (BS08A)
 - 1 - Electrical Plug / Pneumatic Lockout (PL027E)
 - 1 - Cable Lockout Device (CABLO)
 - 2 - No-hole Breaker Lockout (BL04)
 - 2 - Triple-pole Breaker Lockout (BL03)
 - 1 - Multi-pole Breaker Lockout (BL07)
 - 2 - 1.5 in. Steel Lockout Haspa (T220)
 - 1 - Wall Switch Lockout (WSLO)
 - 10 - "Do Not Operate" Lockout Tags (LT10)
 - 1 - Lockout Safety Training Booklet (2112X)
 - 1 - 120-600 AC Voltage Sensor (ESAC600)
 - 3 - 0.75 in. Steel Padlocks, blue (LC041-BU)
 - 1 - Duffel Style Lockout Bag (LX980E)

Catalog #	Description
LK981E	Ultimate Lockout Kit
LK980E	Empty Lockout Bag Only



SafeKey Padlocks

Combination Lockout Duffel

- Everything you need to lock out the most common mechanical and electrical control points, with extra electrical lockout devices
- Components:
 - 1 - Mini Cable Lockout (50940)
 - 1 - 120V Snap-On Breaker Lockout (65387)
 - 1 - 120 / 277V Clamp-On Breaker Lockout (65396)
 - 1 - 480 / 600V Clamp-On Breaker Lockout (65397)
 - 1 - Universal Multi-pole Breaker Lockout (66321)
 - 1 - Oversized Breaker Lockout (65329)
 - 1 - 3-in-1 Electrical Plug Lockout (PLO23)
 - 1 - Wall Switch Lockout (65392)
 - 1 - Small Plug Valve (113231)
 - 1 - Large Plug Valve (113232)
 - 1 - 1 in. to 6.5 in. Adj. Gate Valve Lockout (64057)
 - 1 - 1 in. to 2.5 in. Gate Valve Lockout (65560)
 - 1 - 0.25 in. to 1 in. Ball Valve Lockout (65666)
 - 1 - Large Univ. Valve Lockout w/ Blocking Arm (50899 and 65403)
 - 1 - Lockout Belt Pouch (51172)
 - 1 - Lockout Duffel Bag (99162)
 - Optional:
 - 2 - Keyed-different Padlocks
 - 2 - Heavy-duty Lockout Tags w/ Cable Ties (65520)

Catalog #	Description
150990	Kit w/ 2 SafeKey Nylon Padlocks w/ Steel Shackles and 2 Tags
150989	Kit w/ 2 SafeKey Aluminum Padlocks and 2 Tags
99690	Kit w/ 2 Nylon Padlocks and 2 Tags
99691	Kit w/ 2 Steel Padlocks and 2 Tags
99689	Kit without padlocks or tags

Lockout Tagout



Lockout Kit - Spanish

- Everything you need to lockout electrical and mechanical isolation points. All contents come with Spanish legends.
- Components:
 - 2 - 1.25 in. to 3 in. Steel Ball Valve Lockout (65669)
 - 2 - 0.25 in. to 1 in. Nylon Ball Valve Lockout (65666)
 - 2 - 1 in. to 2.5 in. Gate Valve Lockouts (65560)
 - 2 - 2.5 in. to 5 in. Gate Valve Lockouts (65561)
 - 1 - 110V Electrical Plug Lockout (65674)
 - 1 - 220 / 550V Electrical Plug Lockout (65675)
 - 6 - Wall Switch Lockouts (65392)
 - 6 - 120V Snap-On Breaker Lockouts (65387)
 - 6 - 120 / 277V Clamp-On Breaker Lockouts (65396)
 - 6 - Universal Multi-pole Breaker Lockouts (66321)
 - 5 - Spanish Aluminum Labeled Lockout Hasps
 - 25 - Spanish Lockout Danger Tags w/ Cable Ties
 - 6 - 0.75 in. Keyed-different Steel Padlocks (99504)
 - 6 - 2 in. Keyed-different Steel Padlocks (99528)
 - 2 - Lockout Canvas Security Bags (65780)

Catalog #	Description
65043	Lockout Kit - Spanish

Electrical Lockout Kits

BradyID.com/s36

Electrical Lockout Kits

Standard electrical lockout kits can be purchased with or without padlocks and tags. The padlocks included in these kits are keyed differently (each lock has its own unique key). For keyed alike kits, see the Personal Lockout Kits.



SafeKey Padlocks

Portable Padlock Pouch

- Portable kit includes selection of padlocks, tags and hasps
- Components:
 - 2 - Keyed-different Padlocks
 - 2 - Heavy-duty Lockout Tags w/ Cable Ties (65520)
 - 1 - 1 in. Group Lockout Hasp (133161)
 - 1 - 1.5 in. Group Lockout Hasp (133162)
 - 1 - Lockout Belt Pouch (51172)

Catalog #	Description
150967	Kit w/ 2 SafeKey Nylon Padlocks w/ Steel Shackles
150949	Kit w/ 2 SafeKey Aluminum Padlocks
99290	Kit w/ 2 Nylon Padlocks
99292	Kit w/ 2 Steel Padlocks



Breaker Lockout Pouch Kit

- Contains our most popular circuit breaker lockouts
- Components:
 - 1 - Universal Multi-pole Breaker Lockout (66321)
 - 1 - 120 / 277V Clamp-On Breaker Lockout w/ Cleat (65396)
 - 1 - 480 / 600V Clamp-On Breaker Lockout w/ Cleat (65397)
 - 1 - 120V Snap-On Breaker Lockout (65387)
 - 2 - Lockout Tags
 - 1 - Red Nylon Padlock (99552)
 - 1 - Lockout Pouch (87943)

Catalog #	Description
95538	Breaker Lockout Pouch Kit



Electrical Power Pouch Kit

- Versatile lockout pouch contains useful electrical lockout devices and padlocks
- Components:
 - 2 - Lockout Tags
 - 1 - StoPower™ Electrical Plug Lockout (65673)
 - 1 - Wall Switch Lockout (65392)
 - 1 - 110V Electrical Plug Lockout (65674)
 - 1 - 1 in. Steel Lockout Hasp (133161)
 - 1 - Lockout Pouch (87943)

Catalog #	Description
95548	Electrical Power Pouch Kit
95550	Kit w/ 1 Red Steel Padlock



120 / 277V Breaker Lockout Pouch

- All the devices you need to lockout most 120 / 277V circuit breakers
- Components:
 - 2 - 120V Snap-On Breaker Lockouts (65387)
 - 2 - 120 / 277V Clamp-On Breaker Lockouts w/ Cleats (65396)
 - 2 - Universal Multi-pole Breaker Lockouts w/ Cleats (66321)
 - 1 - Lockout Belt Pouch (51172)
 - Optional:
 - 2 - Keyed-different Padlocks
 - 2 - Heavy-duty Lockout Tags w/ Cable Ties (65520)

Catalog #	Description
99300	120 / 277V Breaker Lockout Pouch Kit
99302	Kit w/ 2 Nylon Padlocks and 2 Tags
99303	Kit w/ 2 Steel Padlocks and 2 Tags



Breaker Lockout Pouch

- Versatile lockout pouch contains the most commonly used electrical lockout devices
- Components:
 - 1 - Universal Multi-pole Breaker Lockout (66321)
 - 1 - 120 / 277V Clamp-On Breaker Lockout (65396)
 - 1 - 480 / 600V Clamp-On Breaker Lockout (65397)
 - 1 - 110V Electrical Plug Lockout (65674)
 - 1 - 1 in. Steel Safety Lockout Hasp (133161)
 - 1 - Lockout Pouch (87943)

Catalog #	Description
95553	Breaker Lockout Pouch



SafeKey Padlocks

Breaker Lockout Sampler Pouch

- One each of our most popular circuit breaker lockouts
- Components:
 - 1 - 120V Snap-On Breaker Lockout (65387)
 - 1 - 120 / 277V Clamp-On Breaker Lockout w/ Cleat (65396)
 - 1 - 480 / 600V Clamp-On Breaker Lockout w/ Cleat (65397)
 - 1 - Universal Multi-pole Breaker Lockout (66321)
 - 1 - Oversized Breaker Lockout (65329)
 - 1 - Lockout Belt Pouch (51172)
 - Optional:
 - 2 - Keyed-different Padlocks
 - 2 - Heavy-duty Lockout Tags w/ Cable Ties (65520)

Catalog #	Description
150969	Kit w/ 2 SafeKey Nylon Padlocks w/ Steel Shackles
150970	Kit w/ 2 SafeKey Compact Nylon Padlocks w/ Nylon Shackles
99296	Kit w/ 2 Nylon Padlocks and 2 Tags
99297	Kit w/ 2 Steel Padlocks and 2 Tags
99293	Kit without padlocks and tags

Lockout Tagout



Electrical Lockout Pouch

- Lightweight, portable pouch contains lockout devices to secure electrical equipment. Convenient metal loops on pouch allow pouch to hang on belt.
- Components:
 - 1 - 120 / 277V Clamp-On Breaker Lockout (65396)
 - 1 - Universal Multi-pole Breaker Lockout (66321)
 - 1 - 110V Electrical Plug Lockout (65674)
 - 2 - Lockout Danger Tags
 - 1 - Aluminum Labeled Lockout Hasp
 - 1 - 2 in. Steel Padlock, Blue (99528)
 - 1 - Lockout Pouch (65292)

Catalog #	Description
65291	Electrical Lockout Pouch



Comprehensive Breaker Lockout Pouch

- Lightweight, portable pouch contains lockout devices to secure electrical equipment. Convenient metal loops on pouch allow pouch to hang on belt.
- Components:
 - 1 - 110V Electrical Plug Lockout (65674)
 - 3 - Wall Switch Lockouts (65392)
 - 3 - Universal Multi-pole Breaker Lockouts (66321)
 - 3 - 120 / 277V Clamp-On Breaker Lockouts w/ Cleats (65396)
 - 2 - 480 / 600V Clamp-On Breaker Lockouts w/ Cleats (65397)
 - 1 - 120 / 277V Additional Cleat (102721)
 - 1 - 480 / 600V Additional Cleat (102722)
 - 1 - Lockout Pouch (65292)

Catalog #	Description
65405	Comprehensive Breaker Lockout Pouch



Electrical Lockout Pouch Kit

- Compact and easy to use lockout pouch with the most common electrical devices
- Components:
 - 1 - 120 / 277V Clamp-On Breaker Lockout w/ Cleat (65396)
 - 1 - 120V Snap-On Breaker Lockout (65387)
 - 1 - 110V Electrical Plug Lockout (65674)
 - 1 - Universal Multi-pole Breaker Lockout (66321)
 - 1 - Wall Switch Lockout (65392)
 - 10 - Lockout Danger Tags (LT10)
 - 1 - 1.5 in. Steel Lockout Hasp (T220)
 - 1 - 0.75 in. Key-retaining Steel Padlock, Blue (143130)
 - 1 - Large Lockout Pouch

Catalog #	Description
134031	Brady Electrical Lockout Pouch Kit



Breaker Lockout Pouch Kit

- Compact and easy to use lockout pouch with the most common circuit breaker lockout devices
- Components:
 - 2 - 120V Snap-On Circuit Breaker Lockouts (65387)
 - 2 - 120 / 277V Clamp-On Breaker Lockouts w/ Cleats (65396)
 - 2 - Universal Multi-pole Breaker Lockouts (66321)
 - 1 - Oversized Breaker Lockout (65329)
 - 10 - Lockout Danger Tags (LT10)
 - 1 - 1.5 in. Steel Lockout Hasp (T220)
 - 1 - 0.75 in. Key-retaining Steel Padlock, Blue (143130)
 - 1 - Large Lockout Pouch

Catalog #	Description
134034	Brady Breaker Lockout Pouch Kit

Electrical Lockout Kits

BradyID.com/s36



Lockout Kit With Large Box

- Versatile lockout kit with essential lockout tagout components
- Components:
 - 3 - 120V Snap-On Breaker Lockouts (65387)
 - 1 - 3-in-1 Electrical Plug Lockout (PLO23)
 - 2 - Universal Multi-pole Breaker Lockouts (66321)
 - 1 - Sheet of Lock Labels (LID-2)
 - 10 - Lockout Danger Tags (LT10)
 - 3 - 1.5 in. Steel Lockout Hasps (T220)
 - 3 - 0.75 in. Key-retaining Steel Padlocks, Blue (143130)
 - 1 - Lockout Safety Training Booklet (2112X)
 - 1 - Plastic Utility Box

Catalog #	Description
134035	Brady Lockout Kit With Large Box



Electrical Lockout Starter Kit

- Contains everything you need to mark and secure a variety of electrical components to protect employees
- Components:
 - 1 - 110V Electrical Plug Lockout (65674)
 - 1 - 220/500V Electrical Plug Lockout (65675)
 - 6 - Wall Switch Lockouts (65392)
 - 6 - 120V Snap-On Breaker Lockouts (65387)
 - 6 - 120 / 277V Clamp-On Breaker Lockouts w/ Cleats (65396)
 - 6 - Universal Multi-pole Breaker Lockouts (66321)
 - 3 - Labeled Group Lockout Hasps (65960 English / 39480 Spanish)
 - 10 - Lockout Tags with Cable Ties
 - 2 - 0.75 in. Steel Padlocks, Blue (99504)
 - 2 - 2 in. Steel Padlocks, Blue (99528)
 - 1 - Canvas Lockout Bag (65780)

Catalog #	Description
65777	English Electrical Lockout Starter Kit (Danger Tags)
121510	Spanish Electrical Lockout Starter Kit (Precaucion Tags)
121513	Spanish Electrical Lockout Starter Kit (Peligro Tags)

Lockout Tagout



SafeKey Padlocks

Basic Electrical Lockout Toolbox

- A handy lockout toolbox kit that includes your most commonly used electrical lockout devices
- Components:
 - 1 - 1 in. to 2.5 in. Gate Valve Lockout (65560)
 - 1 - 0.25 in. to 1 in. Ball Valve Lockout (65666)
 - 1 - 110V Electrical Plug Lockout (65674)
 - 1 - 120 / 277V Clamp-On Breaker Lockouts w/ Cleats (65396)
 - 1 - 480 / 600V Clamp-On Breaker Lockouts w/ Cleats (65397)
 - 1 - Wall Switch Lockout (65392)
 - 1 - Universal Multi-pole Breaker Lockout (66321)
 - 1 - Labeled Group Lockout Hasp (65960)
 - 5 - Lockout Tags (65525)
 - 2 - Padlocks
 - 1 - Lockout Toolbox (65290)

Catalog #	Description
150981	Kit w/ 2 SafeKey Nylon Padlocks (1.5 in. and 3 in. steel shackles)
150982	Kit w/ 2 SafeKey Aluminum Padlocks (1.5 in. and 3 in. shackles)
65289	Kit w/ 2 Steel Padlocks (0.75 in. and 2 in. shackles)

View individual devices

- Padlocks..... page 188
- Mini Cable Lockouts..... page 208
- Cable Lockouts page 208
- Ball Valve Lockouts page 212
- Gate Valve Lockouts..... page 211
- Plug Valve Lockouts page 212
- Breaker Lockouts page 218
- Fuse Lockouts page 224



Lockout Toolbox with Components

- Economical lockout toolbox with the most common electrical circuit breaker lockouts
- Components:
 - 1 - 220 / 550V Electrical Plug Lockout (65675)
 - 1 - 120 / 277V Clamp-On Breaker Lockouts w/ Cleats (65396)
 - 1 - 480 / 600V Clamp-On Breaker Lockouts w/ Cleats (65397)
 - 1 - Universal Multi-pole Breaker Lockout (66321)
 - 2 - Lockout Tags
 - 1 - Nylon Padlock, Red (99552)
 - 1 - Lockout Toolbox (65290)

Catalog #	Description
95540	Lockout Toolbox with Components



Breaker Lockout Toolbox

- Everything you need to lockout most circuit breakers
- Components:
 - 1 - Mini Cable Lockout (50940)
 - 2 - 120V Snap-On Breaker Lockout (65387)
 - 2 - 120 / 277V Clamp-On Breaker Lockouts w/ Cleats (65396)
 - 2 - 480 / 600V Clamp-On Breaker Lockouts w/ Cleats (65397)
 - 1 - Universal Multi-pole Breaker Lockout (66321)
 - 1 - Oversized Breaker Lockout (65329)
 - 1 - Lockout Toolbox (65290)
 - Optional: Optional:
 - 2 - Keyed-different Padlocks
 - 2 - Heavy-duty Lockout Tags w/ Cable Ties (65520)

Catalog #	Description
99305	Breaker Lockout Toolbox Kit
99307	Kit w/ 2 Nylon Padlocks and 2 Tags
99308	Kit w/ 2 Steel Padlocks and 2 Tags



Optional Sign and Rack

SafeKey Padlocks

Economy Lockout Kit with Toolbox

- Ensure equipment is de-energized or locked out in accordance with OSHA regulations
- Sign and Rack also available to conveniently hold the kit
- Components:
 - 3 - 1.5 in. Steel Lockout Hasps (T220)
 - 14 - Padlock Identifier Labels (LID-2)
 - 1 - pkg. (10) - Lockout Tags with Ties (LT10)
 - 3 - Single Pole Breaker Lockouts (BLO1)
 - 2 - Multi-pole Breaker Lockouts (BLO3)
 - 1 - 3-in-1 Electrical Plug Lockout (PLO23)
 - 1 - Lockout Training Booklet (2112X)
 - 1 - Toolbox (7 in. x 12 in. x 5 in.)
 - 3 - Keyed-different Padlocks
 - Optional: 1 Sign and Storage Rack

Catalog #	Description
LKX-SK-NS	Kit w/ 3 SafeKey Nylon Padlocks w/ Steel Shackles
LKX-SK-AL	Kit w/ 3 SafeKey Aluminum Padlocks
LKX	Kit w/ 3 Steel Padlocks
LKXSET	Kit w/ 3 Steel Padlocks, Sign and Storage Rack
LKX-Rack	Sign and Store Rack only



SafeKey Padlocks

Electrical Lockout Toolbox

- Contains all of the basic devices needed to lock out circuit breakers, electrical plugs, wall switches and fuses
- Components:
 - 1 - Mini Cable Lockout (50940)
 - 2 - 120V Snap-On Breaker Lockouts (65387)
 - 2 - 120 / 277V Clamp-On Breaker Lockouts w/ Cleats (65396)
 - 2 - 480 / 600V Clamp-On Breaker Lockouts w/ Cleats (65397)
 - 2 - Universal Multi-pole Breaker Lockouts (66321)
 - 2 - Cleats for 120 / 277V Clamp-On Lockouts (65404)
 - 2 - Cleats for 480 / 600V Clamp-On Lockouts (65406)
 - 1 - Oversized Breaker Lockout (65329)
 - 1 - 3-in-1 Electrical Plug Lockout (PLO23)
 - 1 - Wall Switch Lockout (65392)
 - 1 - Small Fuse Blockout (65690)
 - 1 - Large Fuse Blockout (65691)
 - 1 - Extra-Large Lockout Toolbox (LKP-TKLBOX)
 - 1 - Red Belt Pouch (51172)
 - Optional: 2 - Keyed-different Padlocks, 2 Heavy-duty Tags w/ Cable Ties

Catalog #	Description
150972	Kit w/ 2 SafeKey Nylon Padlocks w/ Steel Shackles and 2 Tags
150971	Kit w/ 2 SafeKey Compact Nylon Padlocks w/ Nylon Shackles and 2 Tags
99312	Kit w/ 2 Nylon Padlocks and 2 Tags
99313	Kit w/ 2 Steel Padlocks and 2 Tags
99310	Kit without padlocks or tags

Valve Lockout Kits

BradyID.com/s36

Valve Lockout Kits

The valve lockout kits can be purchased with or without padlocks and tags. The padlocks included in these kits are keyed differently (each lock has its own unique key). For kits keyed alike, see the Personal Lockout Kits.



Valve Lockout Pouch

- Components:
 - 1 - 1 in. to 6.5 in. Adjustable Gate Valve Lockout (64057)
 - 2 - 0.5 in. to 2.5 in. Small Ball Valve Lockout (BS07A)
 - 1 - Plug Valve Lockout for stem dia. up to 0.875 in. (113231)
 - 1 - Plug Valve Lockout for stem dia. 20.28 in. to 1.375 in. (113232)
 - 1 - Large Lockout Pouch (50979)
 - Optional:
 - 2 - Keyed-different Padlocks
 - 2 - Heavy-duty Lockout Tags w/ Cable Ties (65520)

Catalog #	Description
99680	Kit w/ 2 Nylon Padlocks and 2 Tags
99681	Kit w/ 2 Steel Padlocks and 2 Tags
99679	Valve Lockout Pouch Kit



Gate Valve Lockout Pouch

- Components:
 - 1 - 1 in. to 6.5 in. Adjustable Gate Valve Lockout (64057)
 - 1 - All-Purpose Cable Lockout w/ 8 ft. Sheathed cable (50943)
 - 1 - Nylon Carrying Case (50979)
 - Optional:
 - 2 - Keyed-different Padlocks
 - 2 - Heavy-duty Lockout Tags w/ Cable Ties

Catalog #	Description
102692	Kit w/ 2 Nylon Padlocks and 2 Tags
102693	Kit w/ 2 Steel Padlocks and 2 Tags
101416	Gate Valve Lockout Pouch Kit

Lockout Tagout



Gate Valve Lockout Satchel

- Components:
 - 1 - 1 in. to 2.5 in. Gate Valve Lockout (65560)
 - 1 - 2.5 in. to 5 in. Gate Valve Lockout (65561)
 - 1 - 5 in. to 6.5 in. Gate Valve Lockout (65562)
 - 1 - 6.5 in. to 10 in. Gate Valve Lockout (65563)
 - 1 - 10 in. to 13 in. Gate Valve Lockout (65564)
 - 1 - Lockout Satchel (51173)
 - Optional:
 - 2 - Keyed-different Padlocks
 - 2 - Heavy-duty Lockout Tags w/ Cable Ties (65520)

Catalog #	Description
99677	Kit w/ 2 Nylon Padlocks and 2 Tags
99678	Kit w/ 2 Steel Padlocks and 2 Tags
99676	Gate Valve Lockout Satchel Kit

Looking for kits with keyed-alike padlocks?

See the Personal Lockout Kits section for kits with keyed-alike padlocks.



Valve Lockout Kit

- The essential lockout devices needed for the most common valves in your facility
- Components:
 - 1 - 2.3 in. to 5 in. Gate Valve Lockout (65561)
 - 10 - 7 in. Red Cable Ties (FT100X-RED)
 - 1 - All-Purpose Cable Lockout (50943)
 - 2 - 0.5 in. to 2.5 in. Small Ball Valve Lockout (BS07A)
 - 10 - Bilingual Lockout Tags (TG400B-ONE)
 - 2 - 1.5 in. Steel Lockout Hasp (T220)
 - 2 - 0.75 in. Key-retaining Steel Padlocks, Blue (143130)
 - 1 - Plastic Utility Box (LKP-TKLBOX)

Catalog #	Description
134033	Valve Lockout Kit



Valve Lockout Toolbox

- Everything you need to lock out gate, ball and butterfly valves
- Components:
 - 1 - Small Universal Valve Lockout w/ Blocking Arm (50924 and 65402)
 - 1 - All-Purpose Cable Lockout w/ 8 ft. Sheathed Cable (50943)
 - 1 - 1 in. to 6.5 in. Adjustable Gate Valve Lockout (64057)
 - 1 - 0.25 in. to 1 in. Ball Valve Lockout (65666)
 - 1 - 1 in. to 2.5 in. Gate Valve Lockout (65560)
 - 1 - Extra-Large Lockout Toolbox (LKP-TKLBOX)
 - Optional:
 - 2 - Keyed-different Padlocks
 - 2 - Heavy-duty Lockout Tags w/ Cable Ties (65520)

Catalog #	Description
99321	Kit w/ 2 Nylon Padlocks and 2 Tags
99324	Kit w/ 2 Steel Padlocks and 2 Tags
99320	Kit without padlocks or tags

Lockout Tagout

Lockout Tagout Technical Data Sheets

Download technical sheets for over 350 lockout SKUs including lockout devices and padlocks.

These sheets offer lots of information, including:

- Basic product description and photos
- Material information and temperature resistance
- Chemical resistance
- Detailed dimensional data
- SDS information on the materials

To view all technical data sheets visit at BradyID.com/techdata



Personal Lockout Kits

BradyID.com/s36

Personal Lockout Kits

Personal lockout kits come equipped with keyed-alike padlocks, allowing all the locks in a kit to be opened with a single key. This simplifies key management and ensures that employees can quickly and easily find the right key. For kits containing padlocks that are keyed different (each padlock has its own unique key), see the standard lockout kits on previous pages. Or select a personal lockout kit without padlocks, and purchase the padlocks separately.



Personal Padlock Pouch

- Components:
 - 2 - 1 in. Group Lockout Hasps (133161)
 - 2 - Heavy-duty Lockout Tags w/ Cable Ties (65520)
 - 2 - Keyed-different Padlocks
 - 1 - Lockout Belt Pouch (51172)

Catalog #	Description
105969	Kit w/ 2 Keyed-alike Nylon Padlocks
105970	Kit w/ 2 Keyed-alike Steel Padlocks



Operator Lockout Tagout Kit

- Components:
 - 1 - Lockout Safety Card
 - 1 - Lockout Danger Tag
 - 1 - 1.5 in. Steel Lockout Hasp (T220)
 - 1 - 120 / 277V Clamp-On Breaker Lockout w/ Cleat (65396)
 - 1 - Nylon Padlock, Black (99580)
 - 1 - Plastic Box

Catalog #	Description
134030	Brady Operator Lockout Tagout Kit



SafeKey Padlocks

Standard Lockout Belt Pack

- Components:
 - 1 - Lockout Safety Card
 - 2 - Lockout Danger Tags
 - 1 - Lockout Keychain
 - 2 - 7 in. Red Cable Ties (FT100X-RED)
 - 1 - 1.5 in. Steel Lockout Hasp (T220)
 - 1 - Lockout Pouch (LKPOUCH)
 - 1 - Padlock

Catalog #	Description
LK627E-SK-NS	Kit w/ 1 SafeKey Nylon Padlock w/ Steel Shackles
LK627E-SK-AL	Kit w/ 1 SafeKey Aluminum Padlock
LK627E	Kit w/ 1 Aluminum Padlock

Lockout Tagout



Personal Breaker Pouch

- Covers 120 / 277V and 480 / 600V single- and multi-pole breakers.
- Components:
 - 1 - 120 / 277V Clamp-On Breaker Lockout w/ Cleat (65396)
 - 1 - 480 / 600V Clamp-On Breaker Lockout w/ Cleat (65397)
 - 1 - Universal Multi-pole Breaker Lockout (66321)
 - 2 - 1 in. Group Lockout Hasps (133161)
 - 2 - Heavy-duty Lockout Tags w/ Cable Ties (65520)
 - 1 - Lockout Belt Pouch (51172)
 - Optional: 2 - Keyed-alike Padlocks

Catalog #	Description
105967	Kit w/ 2 Keyed-alike Nylon Padlocks
105968	Kit w/ 2 Keyed-alike Steel Padlocks
105966	Personal Breaker Lockout Pouch Kit



Cable Lockout Kit

- Components:
 - 2 - Cable Lockout Devices (CABLO)
 - 2 - Laminated Steel Padlocks (LC041-BU)
 - 1 - 1 in. Steel Lockout Hasp (T218)
 - 2 - English and Spanish Tags w/ Ties
 - 1 - Polyethylene Carrying Case (7 in. x 12 in. x 5 in.)

Catalog #	Description
LK520B	Cable Lockout Kit



Chain Lockout Kit

- Components:
 - 3 - 1.5 in. Steel Lockout Hasp (T220)
 - 3 - Aluminum Padlocks (LCO44-RD)
 - 3 - Lockout Tags w/ Ties
 - 1 - 48 in. Chain
 - 1 - Carrying Case (7 in. x 12 in. x 5 in.)

Catalog #	Description
LK041R	Lockout Kit w/ 1 Chain
LK042R	Lockout Kit w/ 2 Chains



Personal Basic Lockout Kit

- Contains the basic devices needed to lockout common circuit breakers, valves and plugs
- Components:
 - 1 - 0.5 in. to 2.5 in. Small Ball Valve Lockout (BS07A)
 - 1 - 1 in. to 2.5 in. Gate Valve Lockout (65560)
 - 1 - 120 / 277V Clamp-On Breaker Lockout w/ Cleat (65396)
 - 1 - Universal Multi-pole Breaker Lockout (66321)
 - 1 - Small 110V Electrical Plug Lockout (65674)
 - 2 - 1 in. Lockout Hasps (133161)
 - 2 - Heavy-duty Lockout Tags w/ Cable Ties (65520)
 - 1 - Small Lockout Toolbox (105905)
 - Optional: 2 - Keypad-alike Padlocks

Catalog #	Description
104795	Kit w/ 2 Keypad-alike Nylon Padlocks
104796	Kit w/ 2 Keypad-alike Steel Padlocks
104794	Personal Basic Lockout Kit



SafeKey Padlocks

Personal Breaker Lockout Kit

- Tool box with 2 each of our most popular circuit breaker lockouts
- Covers 120 / 277V and 480 / 600V circuit breakers in single- and multi- pole configurations
- Components:
 - 2 - 120 / 277V Clamp-On Breaker Lockouts w/ Cleats (65396)
 - 2 - 480 / 600V Clamp-On Breaker Lockouts w/ Cleats (65397)
 - 2 - Universal Multi-pole Breaker Lockouts (66321)
 - 3 - 1 in. Red Lockout Hasps (133161)
 - 3 - Heavy-duty Lockout Tags w/ Cable Ties (65520)
 - 1 - Small Lockout Toolbox (105905)
 - Optional: 3 - Keypad-alike Padlocks

Catalog #	Description
150980	Kit w/ 3 Keypad-alike SafeKey Nylon Padlocks w/ Steel Shackles
150979	Kit w/ 3 Keypad-alike SafeKey Compact Nylon Padlocks w/ Nylon Shackles
105964	Kit w/ 3 Keypad-alike Nylon Padlocks
105965	Kit w/ 3 Keypad-alike Steel Padlocks
105963	Kit without padlocks

Lockout Tagout



Basic Lockout Kit with Metal Toolbox

- Rugged lockout toolbox kit with all of the basic components to get your lockout program started
- Components:
 - 5 - 7 in. Red Cable Ties (FT100X-RED)
 - 5 - Lockout Danger Tags
 - 3 - 1.5 in. Steel Lockout Hasps (T220)
 - 1 - Lockout Keychain
 - 2 - 4 in. x 6 in. Magnetic Danger Sign
 - 1 - Lockout Mini Poster (PS811B)
 - 1 - OSHA Lockout Summary Sheet
 - 1 - Number Sheets
 - 1 - Pad of Lockout Tagout Checklists (119076)
 - 1 - Red Metal Toolbox
 - Optional: 3 - 1.5 in. Keypad-alike Aluminum Padlocks, Red

Catalog #	Description
LK907E	Kit w/ 3 Keypad-alike Aluminum Padlocks
LK330E	Basic Lockout Kit



Lockout Kit with Metal Toolbox

- Rugged lockout toolbox kit with all of the basic components to get your lockout program started
- Components:
 - 5 - 7 in. Red Cable Ties (FT100X-RED)
 - 5 - Lockout Danger Tags
 - 3 - 1.5 in. Steel Lockout Hasps (T220)
 - 1 - Lockout Keychain
 - 2 - 4 in. x 6 in. Magnetic Danger Sign
 - 1 - Lockout Mini Poster (PS811B)
 - 1 - OSHA Lockout Summary Sheet
 - 1 - Number Sheets
 - 1 - AC Sensor (65269)
 - 3 - 1.5 in. Keypad-alike Aluminum Padlocks, Red
 - 1 - Red Metal Toolbox

Catalog #	Description
LK331E	Lockout Kit with Metal Toolbox

Personal Lockout Kits

BradyID.com/s36



SafeKey Padlocks

Personal Electrical Lockout Kit

- Contains lockouts for use on most circuit breakers, electrical plugs and disconnect switches.
- Components:
 - 1 - Mini Cable Lockout (50940)
 - 1 - 3-in-1 Electrical Plug Lockout (PLO23)
 - 2 - 120 / 277V Clamp-On Breaker Lockouts w/ Cleats (65396)
 - 1 - 480 / 600V Clamp-On Breaker Lockout w/ Cleat (65397)
 - 2 - Universal Multi-pole Breaker Lockout (66321)
 - 1 - Oversized Breaker Lockout (65329)
 - 3 - 1 in. Group Lockout Hasps (133161)
 - 3 - Heavy-duty Lockout Tags w/ Cable Ties (65520)
 - 1 - Medium Lockout Toolbox (105906)
 - Optional: 3 - Keyed-alike Padlocks

Catalog #	Description
150978	Kit w/ 3 Keyed-alike SafeKey Nylon Padlocks w/ Steel Shackles
150977	Kit w/ 3 Keyed-alike SafeKey Compact Nylon Padlocks w/ Nylon Shackles
105961	Kit w/ 3 Keyed-alike Nylon Padlocks
105962	Kit w/ 3 Keyed-alike Steel Padlocks
105960	Kit without padlocks



Personal Valve Lockout Kit

- Contains lockouts for use on a wide range of gate and ball valves
- Components:
 - 1 - 1 in. to 6.5 in. Adjustable Gate Valve Lockout (64057)
 - 1 - 1 in. to 2.5 in. Gate Valve Lockout (65560)
 - 1 - 0.5 in. to 2.5 in. Small Ball Valve Lockout (BS07A)
 - 1 - All-Purpose Cable Lockout (50943)
 - 3 - 1 in. Group Lockout Hasps (133161)
 - 3 - Heavy-duty Lockout Tags w/ Cable Ties (65520)
 - 1 - Medium Lockout Toolbox (105906)
 - Optional: 3 - Keyed-alike Padlocks

Catalog #	Description
105958	Kit w/ 3 Keyed-alike Nylon Padlocks
105959	Kit w/ 3 Keyed-alike Steel Padlocks
105957	Kit without padlocks

Lockout Tagout



SafeKey Padlocks

Personal Valve and Electrical Lockout Kit

- Provides everything you need to lockout circuit breakers, plugs and valves of various types and sizes
- Components:
 - 1 - All-Purpose Cable Lockout (50943)
 - 1 - 1 in. to 6.5 in. Adjustable Gate Valve Lockout (64057)
 - 1 - Plug Valve Lockout for stem dia. up to 0.875 in. (113231)
 - 1 - Plug Valve Lockout for stem dia. 0.28 in. to 1.375 in. (113232)
 - 1 - 0.5 in. to 2.5 in. Small Ball Valve Lockout (BS07A)
 - 1 - 3-in-1 Electrical Plug Lockout (PLO23)
 - 2 - 120 / 277V Clamp-On Breaker Lockouts w/ Cleats (65396)
 - 1 - 480 / 600V Clamp-On Breaker Lockout w/ Cleat (65397)
 - 2 - Universal Multi-pole Breaker Lockouts (66321)
 - 3 - 1 in. Group Lockout Hasps (133161)
 - 3 - Heavy-duty Lockout Tags w/ Cable Ties (65520)
 - 1 - Medium Lockout Toolbox (105906)
 - Optional: 3 - Keyed-alike Padlocks

Catalog #	Description
150987	Kit w/ 3 Keyed-alike SafeKey Nylon Padlocks w/ Steel Shackles
150988	Kit w/ 3 Keyed-alike SafeKey Aluminum Padlocks
105955	Kit w/ 3 Keyed-alike Nylon Padlocks
105956	Kit w/ 3 Keyed-alike Steel Padlocks
105954	Kit without padlocks

View individual devices

- Padlocks..... page 188
- Mini Cable Lockouts..... page 208
- Cable Lockouts page 208
- Ball Valve Lockouts page 212
- Gate Valve Lockouts..... page 211
- Plug Valve Lockouts page 212
- Breaker Lockouts page 218
- Fuse Lockouts page 224

Custom Lockout Storage

Create your custom lockout kits by picking one of the storage / carrying cases below and filling it with the lockout devices you need.



Lockout Belt Pouch

- Made of heavy duty nylon with loops for hanging on a belt
- Dimensions: 4.75 in. x 7.5 in.

Catalog #	Description
51172	Lockout Belt Pouch



Lockout Satchel

- Nylon satchel with 39 in. shoulder strap
- Includes latchable front pocket and two side mesh holders
- Dimensions: 14 in. x 4 in. x 15 in.

Catalog #	Description
51173	Lockout Satchel



Lockout Toolboxes

- Rugged polypropylene with nickel-plated steel clasps and removable tray
- Two handy storage pockets built into lid
- Small: 7.1 in. x 14 in. x 5.5 in.
Medium: 7.8 in. x 16.2 in. x 7.3 in.

Catalog #	Description
105905	Small Toolbox
105906	Medium Toolbox



Large Lockout Pouch

- Nylon pouch with attachment loop on the back
- Dimensions: 8 in. x 7 in. x 3 in.

Catalog #	Description
50979	Large Lockout Pouch w/ Plastic Zipper
121502	Large Lockout Pouch w/ Metal Zipper



Extra-Large Lockout Toolbox

- Made of rugged polyethylene and includes a removable organizer tray
- Capable of being locked closed
- Dimensions: 5 in. x 12 in. x 7 in.

Catalog #	Description
LKX-TKLBOX	Lockout Toolbox



Large Metal Lockout Cabinet

- All metal, yellow powder-coated cabinet comes with one adjustable shelf
- Capable of being locked closed
- Can also be easily wall mounted using pre-drilled holes in back
- Safety tips printed on inside door
- Dimensions: 16 in. x 14 in. x 6 in.

Catalog #	Description
LC252M	Metal Lockout Cabinet
LC254M	Extra Shelf



Lockout Security Bag

- Made of rugged canvas with drawstring
- Capable of being locked closed
- Dimensions: 9.75 in. x 18 in.

Catalog #	Description
65780	Lockout Security Bag



Lockout Duffel Bag

- Polyester duffel bag with 8 inside pockets and 39 in. removable shoulder strap
- Dimensions: 10 in. x 16.5 in. x 8.5 in.

Catalog #	Description
99162	Lockout Duffel Bag



Ready Access Lockout Station

- Made of polypropylene
- Semi-transparent hinged cover with locking mechanism
- Four small detachable hanging hooks
- Dimensions: 17 in. x 17 in. x 6.75 in.

Catalog #	Description
105942	Ready Access Lockout Station (empty)

Lockout Stations

BradyID.com/s36



Lockout Tagout Stations

Lockout Tagout Stations ensure that lockout devices are properly stored and always accessible when needed. They are a great place to centralize lockout activity needs by organizing the tools, padlocks and padlock keys in one location. Available in portable and wall-mounted styles, these stations are designed with the durability required for an industrial workplace, and can be locked to prevent theft and unauthorized usage.



Lockout Tagout

Combined Lockout / Group Lockout Box Station

- Lockable all metal, yellow powder-coated cabinet comes with one adjustable shelf (extra shelves available)
- Included lock box attaches to bottom of cabinet and holds 8-10 locks
- Cabinet dimensions: 16 in. x 14 in. x 6 in. Lock box: 6 in. x 15 in. x 3 in.
- Components:
 - 1 - 120V Snap-On Breaker Lockouts (65387)
 - 1 - 120 / 277V Clamp-On Breaker Lockout w/ Cleats (65396)
 - 1 - 480 / 600V Clamp-On Breaker Lockout w/ Cleats (65397)
 - 1 - Universal Multi-pole Breaker Lockout (66321)
 - 1 - Oversized Breaker Lockout (65329)
 - 1 - Wall Switch Lockout (65392)
 - 1 - 110V Electrical Plug Lockout (65674)
 - 1 - 3-in-1 Electrical Plug Lockout (PLO23)
 - 1 - 1 in. to 2.5 in. Gate Valve Lockout (65560)
 - 1 - 1 in. to 6.5 in. Adjustable Gate Valve Lockout (64057)
 - 6 - Keyed-different Padlocks
 - 6 - Heavy-duty Lockout Tags w/ Cable Ties (65520)

Industrial Strength Lockout Station

- All metal, yellow powder-coated cabinet comes with one adjustable shelf (extra shelves available)
- Lockout safety tips on inside door
- Wall mounted or easily transported
- Cabinet dimensions: 16 in. x 14 in. x 6 in.
- Components:
 - 3 - Red Nylon Padlocks (99552)
 - 3 - Yellow Nylon Padlocks (99570)
 - 1 - 2.5 in. to 5 in. Safetee™ Donut (SDO4)
 - 1 - 1 in. to 2.5 in. Safetee™ Donut (SDO2)
 - 1 - Single-Pole Breaker Lockout (BLO1)
 - 10 - Lockout Tags with Ties (LT10)
 - 2 - Multi-pole Breaker Lockout (BLO3)
 - 1 - 1 in. Multiple Lockout Device (T218)
 - 1 - Single-Pole Breaker Lockout (BLO4)
 - 1 - 1.5 in. Multiple Lockout Device (T220)
 - 1 - 3-in-1 Electrical Plug Lockout (PLO23)
 - 1 - Small Plug Lockout (PLO21)

Catalog #	Description
99709	Station w/ Components and 6 Nylon Padlocks, 12 Tags
99710	Station w/ Components and 6 Steel Padlocks, 12 Tags
LC252M	Metal Lockout Cabinet (empty)
LG252M	Metal Wall Lock Box Only
LC254M	Extra Shelf

Catalog #	Description
LC251M	Industrial Strength Lockout Station
LC252M	Metal Lockout Cabinet (empty)
LC254M	Extra Shelf



Pictured: Ready Access Valve and Electrical Lockout Station

Ready Access Lockout Station

- Made of thermoformed polypropylene for rugged durability
- Semi-transparent hinged cover with locking mechanism
- Slots in back for wall mounting as well as attachable carrying handle for portability
- 4 detachable hanging hooks inside compartment
- Storage compartment: 4.25 in. x 16 in. x 5.12 in. Cabinet dimensions: 17 in. x 17 in. x 6.75 in.

Ready Access Valve Lockout Station

- 1 - Ready Access Lockout Station (105942)
- 2 - Adjustable Gate Valve Lockouts (64057)
- 1 - All-Purpose Cable Lockout (50943)
- 2 - Ball Valve Lockouts (BS07A)
- 2 - 1 in. Group Lockout Hasps (133161)
- 1 - 1.5 in. Group Lockout Hasp (133162)
- Optional:
 - 6 - Keyed-different Padlocks
 - 6 - Heavy-duty Lockout Tags w/ Cable Ties (65520)

Catalog #	Description
105936	Valve Lockout Station Kit
105937	Kit w/ 6 Nylon Padlocks and Tags
105938	Kit w/ 6 Steel Padlocks and Tags
105942	Ready Access Lockout Station (empty)

SafeKey Padlocks

Ready Access Electrical Lockout Station

- 1 - Ready Access Lockout Station (105942)
- 2 - 3-in-1 Electrical Plug Lockouts (PLO23)
- 1 - Mini Cable Lockout (50940)
- 2 - 120 / 277V Clamp-On Breaker Lockouts w/ Cleats (65396)
- 2 - 480 / 600V Clamp-On Breaker Lockouts w/ Cleats (65397)
- 2 - Universal Multi-pole Breaker Lockouts (66321)
- 1 - Oversized Breaker Lockout (65329)
- 2 - 1 in. Group Lockout Hasps (133161)
- 1 - 1.5 in. Group Lockout Hasp (133162)
- Optional:
 - 6 - Keyed-different Padlocks
 - 6 - Heavy-duty Lockout Tags w/ Cable Ties (65520)

Catalog #	Description
150986	Kit w/ 6 SafeKey Nylon Padlocks and Tags
150985	Kit w/ 6 SafeKey Aluminum Padlocks and Tags
105940	Kit w/ 6 Nylon Padlocks and Tags
105941	Kit w/ 6 Steel Padlocks and Tags
105939	Kit without Padlocks or Tags
105942	Ready Access Lockout Station (empty)

Ready Access Valve and Electrical Lockout Station

- 1 - Ready Access Lockout Station (105942)
- 1 - Adjustable Gate Valve Lockout (64057)
- 1 - All-Purpose Cable Lockout (50943)
- 1 - Ball Valve Lockout (BS07A)
- 1 - 3-in-1 Electrical Plug Lockout (PLO23)
- 2 - 120 / 277V Clamp-On Breaker Lockouts w/ cleats (65396)
- 1 - 480 / 600V Clamp-On Breaker Lockout w/ cleat (65397)
- 2 - Universal Multi-pole Breaker Lockouts (66321)
- 2 - 1 in. Group Lockout Hasps (133161)
- 1 - 1.5 in. Group Lockout Hasp (133162)
- Optional:
 - 6 - Keyed-different Nylon Padlocks (99552) or steel padlocks (99500)
 - 6 - Heavy-duty Lockout Tags w/ Cable Ties (65520)

Catalog #	Description
105933	Valve and Electrical Station Kit
105934	Kit w/ 6 Nylon Padlocks and Tags
105935	Kit w/ 6 Steel Padlocks and Tags
105942	Ready Access Lockout Station (empty)

Lockout Tagout



Pictured: Ready Access Station with 10 Padlocks

Ready Access Padlock Station

- Holds up to 10 padlocks, 6 hasps and 10 tags
- Made of polypropylene for rugged durability
- Semi-transparent hinged cover with locking mechanism
- Slots in back for wall mounting as well as attachable carrying handle for portability
- Space-saving design delivers footprint half the size of competitors
- Dimensions: 17 in. x 13.25 in. x 2.5 in.

SafeKey Padlocks

Padlock Station w/ 5 Padlocks:

- 1 - Ready Access Padlock Station (105932)
- 5 - Keyed-different Padlocks
- 5 - Heavy-duty Lockout Tags w/ Cable Ties (65520)
- 2 - 1 in. Group Lockout Hasps (133161)
- 2 - 1.5 in. Group Lockout Hasps (133162)

Catalog #	Description
105928	Station w/ 5 Nylon Padlocks
105929	Station w/ 5 Steel Padlocks
105932	Ready Access Padlock Station (empty)

Padlock Station w/ 10 Padlocks:

- 1 - Ready Access Padlock Station (105932)
- 10 - Keyed-different Padlocks
- 10 - Heavy-duty Lockout Tags w/ Cable Ties (65520)
- 3 - 1 in. Group Lockout Hasps (133161)
- 3 - 1.5 in. Group Lockout Hasps (133162)

Catalog #	Description
150984	Station w/ 10 SafeKey Nylon Padlocks
150955	Station w/ 10 SafeKey Aluminum Padlocks
105930	Station w/ 10 Nylon Padlocks
105931	Station w/ 10 Steel Padlocks
105932	Ready Access Padlock Station (empty)

Lockout Stations

BradyID.com/s36



Shown without optional lockable clear acrylic door



Shown without optional lockable clear acrylic door



SafeKey Padlocks

Extra-Large Lockout Station

- Polystyrene station with pre-drilled holes for easy wall mounting
- Pegboard-style holes for hooks drilled into back and sides (includes 8 hooks)
- Built-in lock rail holds 20–25 locks
- Dimensions: 30 in. x 25 in. x 5.25 in. Available with or without lockable door
- Components:
 - 1 - All-Purpose Cable Lockout w/ 8 ft. Sheathed Cable (50943)
 - 1 - Large Univ. Valve Lockout w/ Blocking Arm (50899 and 65403)
 - 2 - 120V Snap-On Breaker Lockouts (65387)
 - 2 - 120 / 277V Clamp-On Breaker Lockouts (65396)
 - 2 - 480 / 600V Clamp-On Breaker Lockouts (65397)
 - 2 - Universal Multi-pole Breaker Lockouts (66321)
 - 1 - Oversized Breaker Lockout (65329)
 - 2 - Cleats for 120 / 277V Clamp-On Lockouts (65404)
 - 2 - Cleats for 480 / 600V Clamp-On Lockouts (65406)
 - 1 - Wall Switch Lockout (65392)
 - 1 - 110V Electrical Plug Lockout (65674)
 - 1 - 3-in-1 Electrical Plug Lockout (PLO23)
 - 1 - 0.25 in. to 1 in. Ball Valve Lockout (65666)
 - 1 - 1.25 in. to 3 in. Ball Valve Lockout (65669)
 - 2 - 1 in. to 2.5 in. Gate Valve Lockouts (65560)
 - 1 - 1 in. to 6.5 in. Adj. Gate Valve Lockout (64057)
 - 2 - Labeled Lockout Hasps (65960)
 - 12 - Keyed-different Padlocks
 - 18 - Keyed-different Padlocks
 - 25 - Heavy-duty Lockout Tags w/ Cable Ties (65520)
 - 1 Station with "Lockout Station" legend

Catalog #	Description
Open Style Without Door	
150974	Open Station w/ Components, 18 SafeKey Nylon Padlocks and 25 Tags
150964	Open Station w/ Components, 18 SafeKey Aluminum Padlocks and 25 Tags
99693	Open Station w/ Components, 18 Nylon Padlocks and 25 Tags
99694	Open Station w/ Components, 18 Steel Padlocks and 25 Tags
50993	Open Lockout Station (empty)
Enclosed Style With Lockable Door	
150975	Enclosed Station w/ Components, 18 SafeKey Nylon Padlocks and 25 Tags
150973	Enclosed Station w/ Components, 18 SafeKey Aluminum Padlocks and 25 Tags
99696	Enclosed Station w/ Components, 18 Nylon Padlocks and 25 Tags
99700	Enclosed Station w/ Components, 18 Steel Padlocks and 25 Tags
50995	Enclosed Lockout Station (empty)

Large Lockout Station

- Constructed of sturdy polystyrene with pre-drilled holes for easy wall mounting
- Pegboard-style holes for hooks drilled into back (includes 6 hooks)
- Built-in lock rail holds 15–20 locks
- Dimensions: 26 in. x 19.5 in. x 5 in. Available with or without lockable door
- Components:
 - 1 - All-Purpose Cable Lockout w/ 8 ft. Sheathed Cable (50943)
 - 1 - Large Univ. Valve Lockout w/ Blocking Arm (50899 and 65403)
 - 1 - 110V Electrical Plug Lockout (65674)
 - 1 - 3-in-1 Electrical Plug Lockout (PLO23)
 - 1 - 0.25 in. to 1 in. Ball Valve Lockout (65666)
 - 1 - 1 in. to 2.5 in. Gate Valve Lockout (65560)
 - 1 - 1 in. to 6.5 in. Adjustable Gate Valve Lockout (64057)
 - 2 - Labeled Lockout Hasps (65960)
 - 12 - Keyed-different Padlocks
 - 25 - Heavy-duty Lockout Tags w/ Cable Ties
 - 1 Station with "Lockout Station" or "Estacion de Bloqueo" legend

Catalog #	Description
Open Style Without Door	
99699	English Station w/ Components, 12 Nylon Padlocks and 25 "Danger Do Not Operate" Tags
121508	Spanish Station w/ Components, 12 Nylon Padlocks and 25 "Precaucion No Hacer Funcionar" Tags
121512	Spanish Station w/ Components, 12 Nylon Padlocks and 25 "Peligro No Operar" Tags
99697	English Station w/ Components, 12 Steel Padlocks and 25 "Danger Do Not Operate" Tags
50994	English Open Style Station (empty)
121509	Spanish Open Style Station (empty)
Enclosed Style With Lockable Door	
99703	English Enclosed Station w/ Components, 12 Nylon Padlocks and 25 "Danger Do Not Operate" Tags
99704	English Enclosed Station w/ Components, 12 Steel Padlocks and 25 "Danger Do Not Operate" Tags
50996	English Enclosed Station (empty)

Small Lockout Station

- Constructed of sturdy polystyrene with pre-drilled holes for easy wall mounting
- Pegboard-style holes for hooks drilled into back (includes 4 hooks)
- Built-in lock rail holds 10–15 locks
- Dimensions: 18 in. x 12 in. x 4 in.
- Components:
 - 1 - Mini Cable Lockout (50940)
 - 2 - 120V Snap-On Breaker Lockouts (65387)
 - 2 - 120 / 277V Clamp-On Breaker Lockouts w/ Cleats (65396)
 - 2 - 480 / 600V Clamp-On Breaker Lockouts w/ Cleats (65397)
 - 2 - Universal Multi-pole Breaker Lockouts (66321)
 - 1 - Oversized Breaker Lockout (65329)
 - 1 - Wall Switch Lockout (65392)
 - 1 - 110V Electrical Plug Lockout (65674)
 - 1 - 3-in-1 Electrical Plug Lockout (PLO23)
 - 1 - Small Fuse Blockout (65690)
 - 1 - Large Fuse Blockout (65691)
 - 2 - Labeled Lockout Hasps (65960)
 - 6 - Keyed-different Padlocks
 - 12 - Heavy-duty Lockout Tags w/ Cable Ties (65520)
 - 1 Station with "Lockout Station" legend

Catalog #	Description
99706	Station w/ Components, 6 Nylon Padlocks and 12 Tags
99707	Station w/ Components, 6 Steel Padlocks and 12 Tags
50997	Small Lockout Station (empty)



SafeKey Padlocks

Starter Lockout Station

- Heavy-duty lockout cabinet with the essential items needed to keep your facility safe and locked out
- Components:
 - 1 - Ball Valve Lockout (BS07A)
 - 2 - 2.5 in. to 5 in. Gate Valve Lockout (65561)
 - 2 - 3-in-1 Electrical Plug Lockout (PLO23)
 - 6 - 1.5 in. Steel Lockout Hasp (T220)
 - 50 - 7 in. Red Cable Ties (FT100X-RED)
 - 25 - Lockout Tags (TG027E)
 - 6 - Key-different Padlocks
 - 1 - Lockout Tagout Cabinet Station (LC977A)

Catalog #	Description
LC517E-SK-NS	Station w/ 3 Red and 3 Yellow SafeKey Nylon Padlocks
LC517E-SK-AL	Station w/ 3 Red and 3 Yellow SafeKey Aluminum Padlocks
LC517E	Station w/ 3 Red and 3 Yellow Nylon Padlocks



Safety Lockout Center

- Provides ready access to locks, tags, lockout devices and information
- Made of tough acrylic plastic
- Station size: 30 in. x 24 in. x 4.5 in.
- Components:
 - 6 - Multi-Color Steel Padlocks
 - 2 - 10 pack English Lockout Tags with Ties (LT10)
 - 5 - 1.5 in. Lockout Hasps (T220)
 - 25 - English Lockout Safety Booklets (2112X)

Catalog #	Description
3001	Safety Lockout Center
3012	Board Only



Valve and Electrical Station

- Heavy-duty lockout cabinet contains many common valve and electrical lockout devices needed in a facility
- Components:
 - 1 - Ball Valve Lockout (BS07A)
 - 3 - No-Hole Breaker Lockout (BL04)
 - 3 - Multi-pole Breaker Lockout (BL07)
 - 6 - 1.5 in. Steel Lockout Hasp (T220)
 - 2 - 3-in-1 Electrical Plug Lockout (PLO23)
 - 3 - Wall Switch Lockout (WSLO)
 - 2 - 2.5 in. to 5 in. Gate Valve Lockout (65561)
 - 50 - 7 in. Red Cable Ties (FT100X-RED)
 - 1 - OSHA Lockout Summary Sheet
 - 1 - Lockout Mini Poster (PS811B)
 - 25 - Lockout Tags (TG027E)
 - 1 - Lockout Tagout Cabinet Station (LC977A)

Catalog #	Description
LC518E	Valve and Electrical Lockout Station



Bilingual Safety Lockout Center

- Provides ready access to locks, tags, lockout devices and information
- Made of tough acrylic plastic
- Station size: 30 in. x 24 in. x 4.5 in.
- Components:
 - 6 - Multi-color padlocks
 - 2 - 10 pack Bilingual Tags with Ties (TG400B-10)
 - 5 - 1.5 in. Lockout Hasps (T220)
 - 15 - English Lockout Safety Booklets (2112X)
 - 10 - Spanish Lockout Safety Booklets (2112SPX)

Catalog #	Description
3002	Bilingual Safety Lockout Center
3013	Bilingual Board Only



SafeKey Padlocks

Lockout Tagout Station

- Fully equipped lockout tagout station to store all of your devices
- Components:
 - 1 - 0.5 in. to 2.5 in. Ball Valve Lockout (BS07A)
 - 2 - 2.3 in. to 5 in. Gate Valve Lockouts (65561)
 - 2 - 120 / 277V Clamp-On Breaker Lockout w/ Cleats (65396)
 - 3 - Universal Multi-pole Breaker Lockouts (66321)
 - 2 - 3-in-1 Electrical Plug Lockouts (PLO23)
 - 2 - Wall Switch Lockouts (65392)
 - 6 - 1.5 in. Steel Lockout Hasps (T220)
 - 1 - OSHA Lockout Tagout Summary Sheet
 - 100 - Red Cable Ties (FT100)
 - 25 - Lockout Danger Tags (TG027E)
 - 6 - Keyed-different Padlocks
 - 1 - Lockout Cabinet (LC584E)

Catalog #	Description
150953	Station w/ 3 Red and 3 Yellow SafeKey Nylon Padlocks
150976	Station w/ 3 Red and 3 Yellow SafeKey Aluminum Padlocks
134036	Station w/ 3 Red and 3 Yellow Nylon Padlocks

May we also suggest:



Lockout Station V-Sign

- Enhance the visibility of your Lockout Station with this V-shaped polyethylene sign
- Sign size: 5.5 in. x 10 in.

Catalog #	Description
45367	Lockout Center V-Sign

Lockout Stations

BradyID.com/s36



Wall-Mount Lockout Center

- Large, easily identifiable lockout station holds all of the necessary lockout items
- Components:
 - 2 - 1.5 in. Steel Lockout Hasp (T220)
 - 1 - 2.5 in. to 5 in. Gate Valve Lockout (65561)
 - 1 - 3-in-1 Electrical Plug Lockout (PLO23)
 - 1 - Small Plug Lockout (PLO21)
 - 1 - 0.5 to 2.5 in. Small Ball Valve Lockout (BS07A)
 - 2 - 4 in. x 6 in. Magnetic Danger Sign
 - 1 - Pad of Lockout Tagout Checklists (119076)
 - 1 - Lockout Mini Poster (PS811B)
 - 10 - Lockout Danger Tags
 - 2 - 1.5 in. Red Alum. Lock, Keyed Different (99615)
 - 2 - 1.5 in. Blue Alum. Lock, Keyed Different (99616)
 - 2 - 1.5 in. Yellow Alum. Lock, Keyed Different (99618)
 - 2 - 1.5 in. Green Alum. Lock, Keyed Different (99617)
 - 1 - Large Yellow Lockout Board (LC501E)

Catalog #	Description
LC502E	Lockout Center
LC501E	Lockout Board Only (empty)



4-Lock Board

- Dimensions: 9 in. x 12 in.
- Components:
 - 10 - Lockout Tags (LT10)
 - 1 - 1.5 in. Lockout Hasp (T220)
 - 4 - 0.75 in. Key-retaining Steel Locks (143130)
 - 1 - Lockout Tagout Center (LC202G)

Catalog #	Description
LC203G	Lockout Station
LC202G	Lockout Board Only (empty)



Micro Lockout Station

- Compact and convenient mini-lockout station for essential items
- Components:
 - 5 - 7 in. Red Cable Ties (FT100X-RED)
 - 1 - 1.5 in. Steel Lockout Hasp (T220)
 - 2 - Lockout Tags (LT1)
 - 1 - 0.75 in. Red Key-retaining Steel Padlock (143126)
 - 1 - Micro Lockout Board (LC226A)

Catalog #	Description
KT226A	Micro Lockout Station
LC226A	Board Only (empty)



Small Wall-Mount Lockout Center

- Unfilled, wall-mounted lockout center holds many of your most common devices needed around the facility for easy access and storage

Catalog #	Description
LC744E	Lockout Center (empty)



SafeKey Padlocks

5-Lock Board

- Dimensions: 11.5 in. x 15.5 in.
- Components:
 - 5 - Keyed-different Padlocks
 - 1 - 1 in. Metal Hasp (133161)
 - 1 - 1.5 in. Metal Hasp (133162)
 - 12 - Heavy-duty Tags (65520)

Catalog #	Description
150960	Board w/ 5 SafeKey Aluminum Padlocks
150959	Board w/ 5 SafeKey Nylon Padlocks
51181	Board w/ 5 Nylon Padlocks
51186	Board w/ 5 Steel Padlocks
50989	Board Only (empty)



6-Lock Board

- Dimensions: 14 in. x 14 in.
- Components:
 - 10 - Lockout Tags (LT10)
 - 4 - 1.5 in. Lockout Hasps
 - 24 - Heavy-duty Tags
 - 6 - 0.75 in. Key-retaining Steel Locks (green, yellow, black, white, blue, red)
 - 1 - Lockout Tagout Center (3004Y)

Catalog #	Description
3003Y	Economy Lockout Center
3004Y	Lockout Board Only (empty)

Lockout Tagout

**Custom boards available
Contact Customer Service to order.**



6-Lock Bilingual Board

- Dimensions: 14 in. x 14 in.
- Components:
 - 10 - Bilingual Lockout Tags (TG400B-ONE)
 - 1 - 1 in. Lockout Hasp (T218)
 - 1 - 1.5 in. Lockout Hasp (T220)
 - 6 - 0.75 in. Key-retaining Steel Locks (green, yellow, black, white, blue, red)
 - 1 - Bilingual Lockout Tagout Center (LC210G)

Catalog #	Description
LC211G	Bilingual Lockout Center
LC210G	Bilingual Lockout Board Only (empty)



SafeKey Padlocks

20-Lock Board

- Dimensions: 23.5 in. x 11.5 in.
- Components:
 - 20 - Keyed-different Padlocks
 - 2 - 1 in. Hasps (133161)
 - 2 - 1.5 in. Hasps (133162)
 - 24 - Heavy-duty Tags

Catalog #	Description
150963	Lockout Station Board, Danger Do Not Operate Tags and 20 SafeKey Nylon Padlocks
150983	Lockout Station Board, Danger Do Not Operate Tags and 20 SafeKey Aluminum Padlocks
51189	Lockout Station Board, Danger Do Not Operate Tags and 20 Nylon Padlocks
51194	Lockout Station Board, Danger Do Not Operate Tags and 20 Steel Padlocks
121507	Estacion de Bloqueo Board, Precaucion No Hacer Funcionar Tags and 20 Nylon Padlocks
121511	Estacion de Bloqueo Board, Peligro No Operar Tags and 20 Nylon Padlocks
50991	Lockout Station Board Only
121506	Estacion de Bloqueo Board Only



SafeKey Padlocks

10-Lock Board

- Dimensions: 13.5 in. x 13.5 in.
- Components:
 - 10 - Keyed-different Padlocks
 - 2 - 1 in. Hasps (133161)
 - 2 - 1.5 in. Hasps (133162)
 - 12 - Heavy-duty Tags (65520)

Catalog #	Description
150962	Board and 10 SafeKey Aluminum Padlocks
150961	Board and 10 SafeKey Nylon Padlocks
51187	Board and 10 Nylon Padlocks
51188	Board and 10 Steel Padlocks
50990	Board Only (empty)



SafeKey Padlocks

36-Lock Board

- Dimensions: 21.5 in. x 23.5 in.
- Components:
 - 36 - Keyed-different Padlocks
 - 3 - 1 in. Hasps (133161)
 - 3 - 1.5 in. Hasps (133162)
 - 36 - Heavy-duty Tags (65520)

Catalog #	Description
150965	Board and 36 SafeKey Nylon Padlocks
150966	Board and 36 SafeKey Aluminum Padlocks
51195	Board and 36 Nylon Padlocks
51196	Board and 36 Steel Padlocks
50992	Board Only (empty)



Did you know?

Lock boards contribute to a successful lockout program by providing storage at the point of need for all of your devices

- Boards are made of thick, bright yellow acrylic with acrylic lock rails
- Tag pockets are made of clear polycarbonate and will hold tags up to 3 in. wide



Looking for a portable solution?

Ready Access Padlock Station

- Polypropylene cabinet with lockable door can be carried or wall mounted
- Holds up to 10 padlocks, 6 hasps and 10 tags

See page 243 for more information.

Absorbents and Spill Control

BradyID.com/s36



Why is spill control important?

When a spill occurs, having a proper spill control program that enables a quick and effective response can not only help to protect the environment, but also supports a safe and productive workplace for your employees.

Brady SPC supplies products that help you comply with EPA and OSHA regulations. Why does that matter? Because the cost of non-compliance can have devastating effects on a business's reputation and financial performance.=

The EPA issued its final rule amending SPCC requirements under the authority of the Federal Water Pollution Control Act. This regulation became effective as of August 16, 2002.



The Poly-Edge Truck Mountable Spill Kit is designed to help you meet D.O.T. spill containment regulations.

Absorbents

Need-to-know regulations

The following OSHA and EPA regulations protect your employees and the environment:

29 CFR 1910.22(a)(2)

— Walking-Working Surfaces

The floor of every workroom shall be maintained in a clean and, so far as possible, a dry condition. Where wet processes are used, drainage shall be maintained, and false floors, platforms, mats, or other dry standing places should be provided where practicable.

40 CFR 112.7(c)(1)(viii)

— General requirements for Spill Prevention, Control, and Countermeasure Plans

Sorbent materials are included in the types of prevention systems that must be used for spill containment.

29 CFR 1910.120(j)(1)(vii)

— Hazardous Waste Operations and Emergency

U.S. Department of Transportation specified salvage drums or containers and suitable quantities of proper absorbents shall be kept available and used in areas where spills, leaks, or ruptures may occur.

OSHA's recent silica ruling

One of the most common compositions for granular absorbents is diatomaceous earth, which is 80-90% silica based. OSHA's recent final rule on limiting exposure to respirable crystalline silica was issued to curb lung cancer, silicosis, chronic obstructive pulmonary disease and kidney disease, all of which have been linked to high levels of silica. Rely on Brady SPC absorbent pads and rolls as safer, more efficient, non-silica solutions for absorbing leaks, drips and spills.



What is a SPCC Plan and do I need one?

A Spill Prevention Control and Countermeasure (SPCC) plan is a facility-specific, comprehensive plan outlining both the containment and countermeasures implemented to prevent a spill from occurring, and a series of response procedures in the event that one does occur. The SPCC plan addresses the following three areas:

- Operating procedures that prevent spills
- Control measures installed to prevent a spill from reaching the environment
- Countermeasures to contain, clean up and mitigate the effects of an oil spill that reaches the environment



Having an SPCC plan in place is an essential step to help companies avoid the costly impact of non-compliance, including fines as high as \$25,000 per day per violation.

Not sure where to start? Let SPC experts help

We understand that surveying a facility for potential trouble spots, proper absorbent usage and product selection can be time consuming and confusing. But, it is extremely beneficial.

- **Free Absorbent Survey**

Brady's absorbent survey is a free service designed to help you keep your employees and equipment safe. This detailed survey asks the right questions and identifies how Brady SPC and its distributors can provide solutions for the proper use of absorbents in the plant. Many organizations use these surveys as an "environmental audit" and keep them on file.

- **Cost Savings Worksheet**

Seeing is believing. This simple worksheet helps you compare the absorbents you are currently purchasing to our recommendations — quickly showing you the price difference and your cost savings.

**Contact your
Brady SPC
Representative for
more information,
or for assistance
selecting the right
absorbents for your
facility.**

Absorbents and Spill Control

BradyID.com/s36

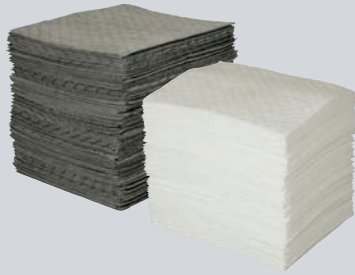

Making the switch to absorbents

No facility is free from leaks, drips and spills. And, when it comes to keeping your employees and the working environment safe, you need a reliable and cost-effective absorbent solution.

Take a look at the comparisons below between clay granular, rags and SPC absorbent pads to determine what solution best fits your needs.

Clay granular

- **Pros:** Low cost per bag and product familiarity
- **Cons:** Messy, very low absorbency ratio (generally 1:1), labor intensive clean up and high disposal costs

Laundered rags

- **Pros:** Recycled and full system (products and disposal supported by the supplier)
- **Cons:** After each laundering, the rags lose some of their absorbency. Hard metals can never be completely removed, leading to significant health risks through exposure

SPC absorbent pads

- **Pros:** Absorb an average of 20x their weight in liquid, offer multiple configurations and constructions and lower disposal costs
- **Cons:** Higher up-front cost

Material details

	Clay granular (40 lb bag)	Rags (200 pads/drum)	SPC pads (100 pads/case)	
Gallons absorbed per week	20	20	20	gallons
Total material used	4 bags	170 rags	77 pads	per week
Total material costs	\$24	\$128	\$77	per week

Labor details

Labor hours for clean-up	1	0.3	0.3	hours/week
Total labor costs	\$20	\$7	\$7	per week

Disposal details

Drums disposed per week	1	(included)	0.15	per week
Total disposal costs	\$200	(included)	\$30	per week

Savings summary

Weekly cost	\$244	\$135	\$114	per week
Annual cost	\$12,688	\$7,020	\$5,947	per year
Total cost after 5 year	\$63,440	\$35,100	\$29,733	over 5 years

\$33,667 or 47% savings
When using SPC pads over clay granular

*Values shown are for example purposes only and are based on average costs in US dollars as published in 2016. Costs and savings may vary.

1 Step one: Know what you're absorbing

Water- or oil-based fluids

SPC recommends: Universal Absorbents

Use around machinery, under leaky pipes, in messy traffic areas or for general maintenance projects. Re-Form™ universal absorbents are made of recycled materials and offer an environmentally friendly solution.

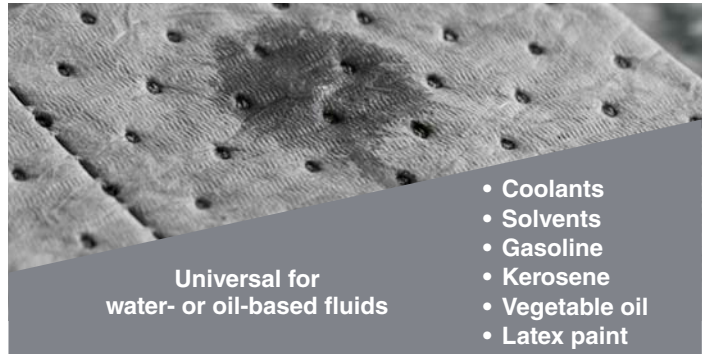

Oil-based fluids outdoors/water repelling

SPC recommends: Oil-Only Absorbents

Specialized for oil and other petroleum-based spills including paints and non-water soluble chemicals, these absorbents do not absorb water and float indefinitely. Re-Form™ oil-only absorbents are made of recycled materials and offer an environmentally friendly solution.

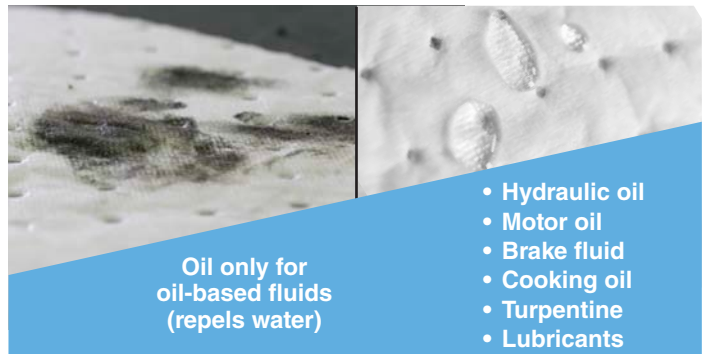

Hazardous chemical fluids

SPC recommends: Chemical Absorbents

Surfactant-treated polypropylene absorbents can be used on a wide range of chemicals, including hydrofluoric acid. They are chemically inert, so they will not react with aggressive fluids.

Keep in mind that absorbents take on the properties of whatever they absorb, so the bright color provides a visual indication to separate waste streams.

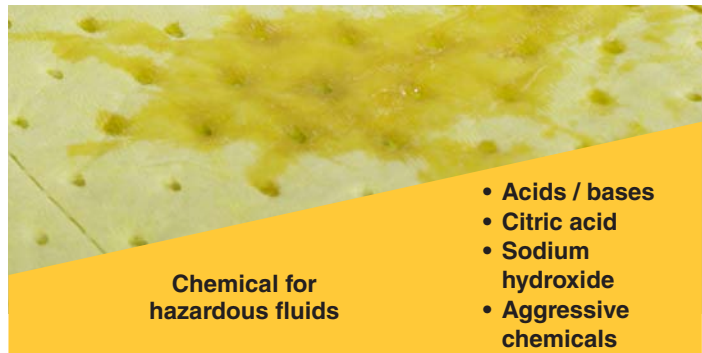

Looking to save time, effort and money?

Use a mid- to high-level universal product, like MRO100, as the standard in your facility. These absorbents can be used in a wide variety of applications and with a standardized absorbent, you do not have to manage the inventory of multiple items.

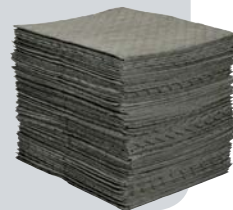

Absorbents and Spill Control

BradyID.com/s36

2 Step two: Identify your application



General purpose wiping, drips and leaks

SPC recommends: Pads, Rolls, Socks and Pillows

Pre-cut pads and perforated rolls provide easy access to absorbents for general purpose use around your facility. Use specialized SOCs and pillows around or underneath dripping equipment.



Heavy foot and forklift traffic

SPC recommends: Mats and Rugs

Mats and rugs offer greater durability to withstand harsh conditions. Barrier-backed options prevent liquid from penetrating the absorbent and reaching the floor underneath while printed mats warn of possible slip, trip and fall hazards.



Emergency spill response

SPC recommends: Spill Kits, Pallets, Drain Plugs

Spill kits bundle all of the necessary products to clean up an unexpected spill. Other spill containment options include spill pallets, drain plugs and storage centers.



Specialty absorbents

SPC recommends: Marine or Granular Products

Marine environments require boom, sweep and drag nets to remove fluids in, or near, bodies of water.

Granular absorbents are available when loose absorbents are preferred or when acid/base neutralization is required prior to spill clean up.

Absorbents

3 Step three: Select absorbent features

Coverstock

Durability of an absorbent increases with the addition of a coverstock layer.

- For simple drips or leaks, a 1-ply absorbent is all you need
- For wiping scenarios or foot traffic areas, a 3-ply absorbent will offer the necessary durability
- For abrasive applications, a pad with spunbond coverstock helps to reduce linting or tearing

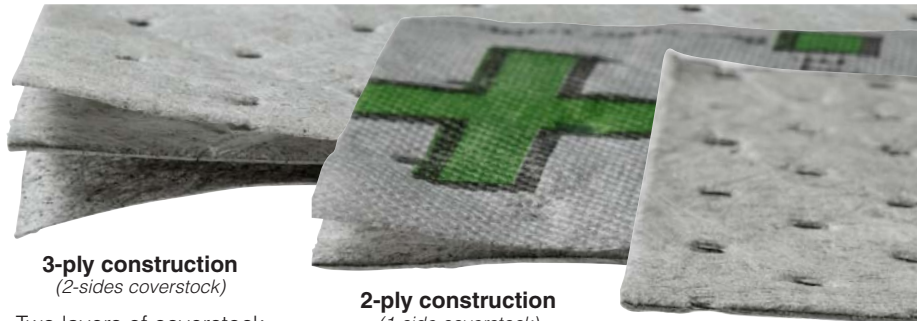

3-ply construction
(2-sides coverstock)
Two layers of coverstock offer maximum durability and reduce linting or tearing.

2-ply construction
(1-side coverstock)
A single layer of coverstock offers medium durability and linting.

1-ply construction
(No coverstock)
Economical single-ply has lower durability resulting in high linting and tearing.

Absorbency weight

The absorbency weight can make a significant difference in how much product is required.

- For small spills, choose a light- or medium-weight product to avoid waste
- For large spills or continuous leaks, choose a heavy-weight product to reduce material use



Under-saturated
Absorbents aren't being used to their full potential. You're throwing money away!



Over-saturated
Absorbents aren't cleaning the whole spill. Increase the weight to get the job done with less product.

Dimpled surface

Dimpling increases product strength for areas requiring greater durability.

Smooth absorbents have greater surface area and are more absorbent per square inch compared to similarly constructed, dimpled products.



Non-dimpled
Offers more absorbent surface area.

Dimpled
Provides increased durability.

Perforations

Perforations provide a variety of size options by allowing you to quickly tear off exactly what is needed to contain the spill.

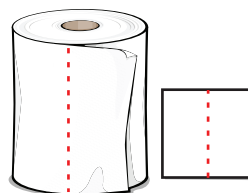

Single perforation
Featured on many pads and rolls

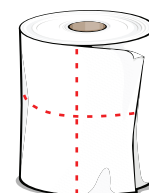

Double perforation
Featured on many rolls and mats

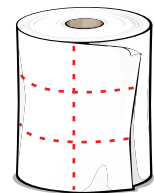

Triple perforation
Unique to the High Traffic Universal rolls

Universal Absorbency

BradyID.com/s36

Universal Absorbency for Water- or Oil-Based Fluids

All-purpose absorbents clean-up oils, coolants, solvents and water-based fluids anywhere in your facility.

Around machinery, under leaky pipes or fittings, in messy traffic areas, for general maintenance projects — they are your first choice for indoor spill control. Plus, their gray color masks spills and stains, helping you resist the urge to pick up the absorbent before it is fully saturated.



Liquids absorbed

- Coolants
- Solvents
- Oils
- Latex paint
- Gasoline
- Vegetable oil
- Kerosene
- Water-based fluids

Popular applications

- Wiping tools
- Small spills
- Under leaky pipes
- Around liquid storage containers
- Around machinery
- In messy traffic areas
- Under dripping valves
- General purpose maintenance

Absorbents

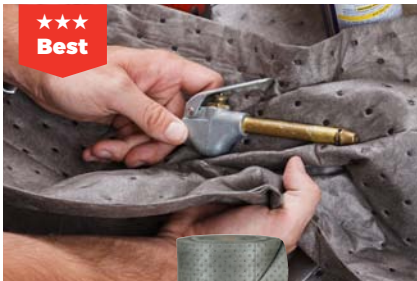

MRO Plus® Absorbents

- Brady SPC's number one universal absorbent and the standard in all-purpose, gray maintenance absorbents
- Universal absorbency handles most fluids (water, petroleum and chemical-based)
- 3-ply (MMM) meltblown polypropylene construction increases durability and reduces lint

Features

- For oils, coolants, solvents and water-based fluids
- Top and bottom coverstock (3-ply)
- High durability
- Medium linting
- Perforated and dimpled
- Gray color masks spills
- Heavy, medium and light weights
- Cost: \$\$\$

Recommended applications

- Anywhere there is a leak, drip or spill
- Production/machine areas
- Under assembly lines or equipment
- Maintenance areas and liquid storage areas

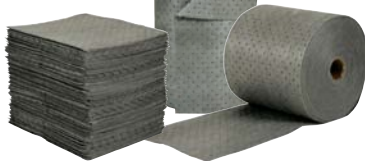

Catalog #	Type	Size	Perforated	Absorbency Factor (gl/gs)	Absorbency Capacity (gal)	Shipping Wt. (lbs)	Pallet Qty.	Quantity
Pads								
MRO50	Heavy-weight pad	30 in. x 30 in.	Yes, 15 in.	12.5	41	26.5	11	50/case
MRO150DND	Heavy-weight pad *	15 in. x 19 in.	Yes, 7.5 in.	12.5	39	27	18	150/case
MRO100	Heavy-weight pad	15 in. x 19 in.	Yes, 7.5 in.	12.5	26	17.5	30	100/case
MRO100-2	Heavy-weight pad	15 in. x 19 in.	Yes, 7.5 in.	12.5	13.5	8	36	50/bale
MRO300	Medium-weight pad	15 in. x 19 in.	Yes, 7.5 in.	12.5	20.5	14	30	100/case
Rolls								
MRO30-DP	Heavy-weight roll	30 in. x 150 ft.	Yes, 15 in. and every 15 in.	12.5	49	32	12	1/case
MRO30P	Heavy-weight roll	30 in. x 150 ft.	Yes, every 30 in.	12.5	49	32	12	1/case
MRO30	Heavy-weight roll	30 in. x 150 ft.	No	12.5	49	33	12	1/case
MRO15-DP	Heavy-weight roll	15 in. x 150 ft.	Yes, 7.5 in. and 12 in. across	12.5	24	17.5	24	1/case
MRO15P	Heavy-weight roll	15 in. x 150 ft.	Yes, every 18 in.	12.5	24	17.5	24	1/case
MRO15	Heavy-weight roll	15 in. x 150 ft.	No	12.5	24	17.5	24	1/case
MRO350-DP	Medium-weight roll	30 in. x 150 ft.	Yes, 15 in. and every 15 in.	12.5	38	26.5	12	1/case
MRO315P	Medium-weight roll	15 in. x 150 ft.	Yes, every 18 in.	12.5	20	14	24	1/case
MRO215P	Light-weight roll	15 in. x 150 ft.	Yes, every 18 in.	12.5	12	8	24	1/bale

*Features Dispense-N-Dispose® System



GP “General Purpose” Absorbents

- Economical general purpose absorbents offer the look, feel and performance of a premium product
- Universal absorbency to handle most fluids (water, petroleum and chemical-based)
- Efficient single-ply construction with MAXX® Technology — absorption and strength without the extra weight

Features

- For oils, coolants, solvents and water-based fluids
- No coverstock (1-ply)
- Medium durability
- Medium linting
- Perforated and dimpled
- Gray color masks spills
- Heavy, medium and light weights
- Cost: \$\$

Recommended applications

- Anywhere there is a leak, spill or drip
- Ideal for industrial settings such as machine shops, maintenance or manufacturing
- Under leaky pipes and machinery

Catalog #	Type	Size	Perforated	Absorbency Factor (g/gs)	Absorbency Capacity (gal)	Shipping Wt. (lbs)	Pallet Qty.	Quantity
Pads								
GP100	Heavy-weight pad	15 in. x 19 in.	Yes, 7.5 in.	20	30	12	30	100/case
GP300	Medium-weight pad	15 in. x 19 in.	Yes, 7.5 in.	20	25	10	30	100/bale
GP200	Light-weight pad	15 in. x 19 in.	Yes, 7.5 in.	20	44	16	22	200/case
GP500	Light-weight pad	15 in. x 19 in.	Yes, 7.5 in.	20	22	8.2	30	100/case
MXU1000	Light-weight pad (non-dimpled)	15 in. x 19 in.	Yes, 7.5 in.	24	27	8	30	100/case
Rolls								
GP30	Heavy-weight roll	30 in. x 150 ft.	No	13	48	28	12	1/bale



BASIC Universal Absorbents

- Value-priced universal all-purpose absorbent
- Universal absorbency to handle most fluids (water, petroleum and chemical-based)
- Economical single-ply pads and rolls made of universal meltblown polypropylene

Features

- For oils, coolants, solvents and water-based fluids
- No coverstock (1-ply)
- Light durability
- High linting
- Perforated and dimpled
- Gray color masks spills
- Heavy and light weights
- Cost: \$

Recommended applications

- Anywhere there is a leak, spill or drip
- General industrial applications
- Manufacturing, printing and transportation

Catalog #	Type	Size	Perforated	Absorbency Factor (g/gs)	Absorbency Capacity (gal)	Shipping Wt. (lbs)	Pallet Qty.	Quantity
Pads								
BPU100	Heavy-weight pad	15 in. x 17 in.	Yes, 7.5 in.	18	20.5	8.5	30	100/bale
BPU200	Light-weight pad	15 in. x 17 in.	Yes, 7.5 in.	18	34	13.7	24	200/bale
BPU500	Light-weight pad	15 in. x 17 in.	Yes, 7.5 in.	18	17	7	36	100/bale
Rolls								
BRU150	Heavy-weight roll	30 in. x 150 ft.	Yes, every 30 in.	14.5	38	19.5	18	1/bale
BRU152	Heavy-weight split roll	15 in. x 150 ft.	Yes, every 30 in.	14.5	38	19.5	18	2/bale

Universal Absorbency

BradyID.com/s36



BattleMat® Absorbents

- Tough camouflage-patterned roll hides leaks and drips and is ideal for areas with moderate foot traffic
- Universal absorbency to handle most fluids (water, petroleum and chemical based)
- Durable 2-ply construction is ideal for use in high traffic areas — foot or forklift traffic
- Abrasion-resistant upper layer helps reduce linting while meltblown fibers grip the floor below

Features

- For oils, coolants, solvents and water-based fluids
- Camouflaged-printed top coverstock (2-ply)
- High durability and low linting
- Perforated
- Camouflaged pattern masks spills
- Cost: \$\$\$

Recommended applications

- Extra tough for foot and forklift traffic
- Walkways and high traffic areas
- Where there's a need to mask spills
- Under assembly lines, equipment or vehicles

Catalog #	Type	Size	Perforated	Absorbency Factor (gl/g)	Absorbency Capacity (gal)	Shipping Wt. (lbs)	Pallet Qty.	Quantity
Rolls								
BM30	Heavy-weight roll	30 in. x 150 ft.	Yes, 15 in. and every 15 in.	12.5	53	34.5	12	1/case
BM15	Heavy-weight roll	15 in. x 150 ft.	Yes, 7.5 in. and 12 in. across	12.5	26	17	24	1/case



HT "High Traffic" Absorbents

- Multi-use absorbent built for durability and high absorbency in "high traffic" areas
- Universal absorbency to handle most fluids (water, petroleum and chemical based)
- 2-ply construction coverstock reduces linting and increases durability while meltblown fibers grip the floor below
- Printed safety message warns of slip, trip and fall hazards due to liquid spills

Features

- For oils, coolants, solvents and water-based fluids
- Top coverstock (2-ply) with safety message
- Medium durability and low linting
- Perforated and dimpled
- Heavy, medium and light weights
- Cost: \$\$

Recommended applications

- Extra tough for foot traffic and walkways
- Printed safety message for areas where slips, trips and falls may occur

Catalog #	Type	Size	Perforated	Absorbency Factor (gl/g)	Absorbency Capacity (gal)	Shipping Wt. (lbs)	Pallet Qty.	Quantity
Rolls								
HT30	Heavy-weight roll	30 in. x 150 ft.	Yes, 15 in. and every 15 in.	12.5	47	32	12	1/case
HT555	Heavy-weight roll*	15 in. x 150 ft.	Triple perf, 5 in. and every 18 in.	12.5	23	16	24	1/case
HT15	Heavy-weight roll	15 in. x 150 ft.	Yes, every 15 in.	12.5	23	16	24	1/case
HT303	Medium-weight roll	30 in. x 300 ft.	Yes, 15 in. and every 15 in.	12.5	63	40	8	1/bale
HT350	Medium-weight roll	30 in. x 150 ft.	Yes, 15 in. and every 18 in.	12.5	35	20	12	1/bale
HT153	Medium-weight roll	15 in. x 300 ft.	Yes, every 15 in.	12.5	32	20	16	1/bale
HT230	Light-weight roll	30 in. x 300 ft.	Yes, 15 in. and every 15 in.	12.5	42.5	29.5	8	1/bale
HT215	Light-weight roll	15 in. x 300 ft.	Yes, every 15 in.	12.5	21.5	15	16	1/bale

* Does not include printed safety message.

Absorbents

Specialty product:
For high abrasion



UXT "Xtra Tough" Absorbents

- Extra tough absorbents for applications that require high durability, non-linting and abrasion-resistance such as when wiping tools or machinery
- Universal absorbency to handle most fluids (water, petroleum and chemical based)
- 3-ply construction with 2 sides of coverstock for maximum durability and minimal linting
- Extra strength allows for wringing and re-use

Features

- For oils, coolants, solvents and water-based fluids
- Top and bottom coverstock (3-ply)
- High durability and low linting
- Perforated and dimpled
- Heavy, medium and light weights
- Cost: \$\$\$

Recommended applications

- Wiping highly abrasive surfaces such as tools and machinery
- Machining, maintenance or food processing

Catalog #	Type	Size	Perforated	Absorbency Factor (gl/g)	Absorbency Capacity (gal)	Shipping Wt. (lbs)	Pallet Qty.	Quantity
Pads								
UXT100	Heavy-weight pad	15 in. x 19 in.	Yes, 7.5 in.	11	19.5	14.5	30	100/case
UXT300	Medium-weight pad	15 in. x 19 in.	Yes, 7.5 in.	11	17	12	30	100/case
UXT200	Light-weight pad	15 in. x 19 in.	Yes, 7.5 in.	11	31.5	18.5	22	200/case
Rolls								
UXT30DP	Heavy-weight roll	30 in. x 150 ft.	Yes, 15 in. and every 15 in.	11	37	27.5	12	1/case
UXT15P	Heavy-weight roll	15 in. x 150 ft.	Yes, every 18 in.	11	17	14.5	24	1/case

Specialty product:
Portability & small spills



Spill Response Plus Universal Absorbents

- Convenient, portable size perfect for employees to fold or carry in their pockets
- Universal absorbency to handle most fluids (water, petroleum and chemical based)
- Fine fiber coverstock on each side increases product versatility

Features

- For oils, coolants, solvents and water-based fluids
- Top and bottom coverstock (3-ply)
- High durability and medium linting
- Perforated and dimpled
- Heavy weight
- Cost: \$\$

Recommended applications

- Anywhere there is a leak, drip or spill
- Janitorial and maintenance
- Hospitality and retail

Catalog #	Type	Size	Perforated	Absorbency Factor (gl/g)	Absorbency Capacity (gal)	Shipping Wt. (lbs)	Pallet Qty.	Quantity
Pads								
SRP100	Heavy-weight pad	7.5 in. x 10 in.	No	12.5	5.5	4	96	100/case
SRP200	Heavy-weight pad	7.5 in. x 10 in.	No	12.5	11.1	7.5	48	200/case
Rolls								
SRP75P	Heavy-weight roll	7.5 in. x 50 ft.	Yes, 10 in.	12.5	3.3	1.85	60	1/bale

Request a free sample pack today

With a Brady SPC sample pack, you can put absorbent pads to the test in your facility without making any commitments.

▶ Request a sample today a BradyID.com/SPC



Universal Absorbency

BradyID.com/s36



Re-Form™ Eco-Friendly Universal Absorbents for water- or oil-based fluids

Re-Form absorbent pads and rolls are eco-friendly, green products made of recycled materials. They feature the same universal absorbency as their polypropylene counterparts, making them ideal for coolants, solvents, oils and other water-based or petroleum-based fluids.

Re-Form absorbent materials have been tested to absorb 25-50% more than polypropylene materials, which means you'll use less product to absorb the same size spill.



Re-Form™ Pro Plus Absorbents

- The look, feel and performance of a traditional absorbent, but made from 90% recycled fibers. Supports corporate sustainability and LEED initiatives
- Universal absorbency to handle most fluids including water, petroleum and non-aggressive chemicals
- Durable 3-ply construction is made of 90% recycled materials
- Extremely absorbent: absorbs 20 times its weight

Features

- For oils, water-based fluid and non-aggressive chemicals
- Top and bottom coverstock (3-ply)
- Medium durability and medium linting
- Perforated and dimpled
- Heavy weight
- Cost: \$ \$ \$

Recommended applications

- Anywhere there is a leak, drip or spill
- Production/machine areas
- Maintenance areas

Catalog #	Type	Size	Perforated	Absorbency Factor (g/g)	Absorbency Capacity (gal)	Shipping Wt. (lbs)	Pallet Qty.	Quantity
Pads								
RFPP100	Heavy-weight pad	15 in. x 19 in.	Yes, 7.5 in.	12.5	26	17.5	30	100/case

Re-Form absorbents are not intended for use with aggressive chemicals.

Absorbents

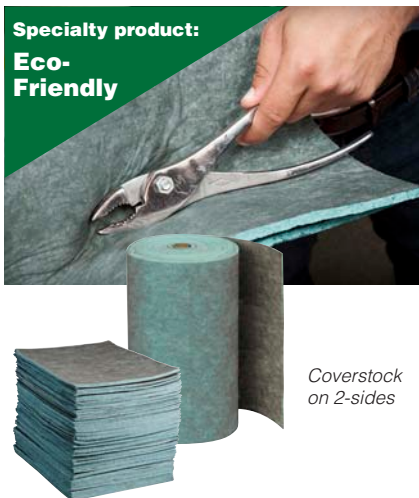

Re-Form™ XPlus Absorbents

- A medium weight absorbent with meltblown coverstock on both sides for added durability making it ideal for leaks, drips, spills and areas with light foot traffic
- Universal absorbency to handle most fluids including water, petroleum and non-aggressive chemicals
- Durable 3-ply construction made from 80% recycled cellulose and absorbent rags
- Up to 50% more absorbent than comparable polypropylene absorbents
- Class A fire retardant

Features

- For oils, water-based fluid and non-aggressive chemicals
- Top and bottom coverstock (3-ply)
- Medium durability and medium linting
- Perforated
- Medium weight
- Cost: \$ \$ \$

Recommended applications

- Anywhere there is a leak, drip or spill
- General purpose absorbent
- Light foot traffic

Catalog #	Type	Size	Perforated	Absorbency Factor (g/g)	Absorbency Capacity (gal)	Shipping Wt. (lbs)	Pallet Qty.	Quantity
Pads								
RFDP300	Medium-weight pad	16 in. x 18 in.	Yes, 7.5 in.	16.5	32	16.6	24	100/case
Rolls								
RFDP328-DP	Medium-weight roll	28.5 in. x 150 ft.	Yes, 14.25 in. and every 19 in.	16.5	55	33.3	8	1/case

Re-Form absorbents are not intended for use with aggressive chemicals.



Specialty product:
Eco-Friendly

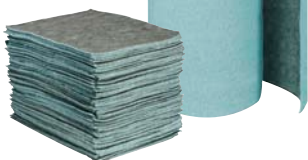

Coverstock on 1-side

Re-Form™ Plus Absorbents

- Eco-friendly, all-purpose absorbent for wiping, drips and leaks
- Universal absorbency to handle most fluids including water, petroleum and non-aggressive chemicals
- Durable 2-ply construction made from 80% recycled cellulose and highly absorbent rags
- Up to 50% more absorbent than comparable polypropylene absorbents
- Class A fire retardant

Features

- For oils, water-based fluid and non-aggressive chemicals
- Top coverstock (2-ply)
- Medium durability and medium linting
- Perforated
- Heavy, medium and light weight
- Cost: \$ \$

Recommended applications

- Anywhere there is a leak, drip or spill
- Production/machine areas
- Under equipment or machinery

Catalog #	Type	Size	Perforated	Absorbency Factor (g/gs)	Absorbency Capacity (gal)	Shipping Wt. (lbs)	Pallet Qty.	Quantity
Pads								
RFP100	Heavy-weight pad	15 in. x 19 in.	Yes, 7.5 in.	17	40	19.5	18	100/case
RFP300	Medium-weight pad	15 in. x 19 in.	Yes, 7.5 in.	17	32	16	24	100/case
RFP500	Light-weight pad	15 in. x 19 in.	Yes, 7.5 in.	17	24	12.7	30	100/case
Rolls								
RFP328-DP	Medium-weight roll	28.5 in. x 150 ft.	Yes, 14.25 in. and every 19 in.	17	54	30.5	8	1/case
RFP314P	Medium-weight roll	14.25 in. x 150 ft.	Yes, every 19 in.	17	30	15.5	20	1/case

Re-Form absorbents are not intended for use with aggressive chemicals.



Specialty product:
Eco-Friendly



No coverstock

Re-Form™ Absorbents

- Economical general purpose absorbent offering superior absorbency compared to meltblown polypropylene; up to 50% more absorbent
- Universal absorbency to handle most fluids including water, petroleum and non-aggressive chemicals
- Single-ply nylon mesh construction made from 80% recycled cellulose and highly absorbent rags
- Up to 50% more absorbent than comparable polypropylene absorbents
- Class A fire retardant

Features

- For oils, water-based fluid and non-aggressive chemicals
- No coverstock (1-ply)
- Light durability and high linting
- Heavy, medium and light weight
- Cost: \$

Recommended applications

- Anywhere there is a leak, drip or spill
- Production/machine areas
- Maintenance areas with limited foot traffic

Catalog #	Type	Size	Perforated	Absorbency Factor (g/gs)	Absorbency Capacity (gal)	Shipping Wt. (lbs)	Pallet Qty.	Quantity
Pads								
RF100	Heavy-weight pad	15 in. x 19 in.	No	17.5	40	19	18	100/case
RF300	Medium-weight pad	15 in. x 19 in.	No	17.5	32	14.8	24	100/case
RF500	Light-weight pad	15 in. x 19 in.	No	17.5	24	12	30	100/case

Re-Form absorbents are not intended for use with highly aggressive chemicals.

Oil-Only Absorbency

BradyID.com/s36

Oil-Only Absorbency

Absorb oil- and petroleum-based fluids while repelling water

Oil-only absorbents are specially designed to clean-up oils and petroleum-based liquids while also repelling water and floating indefinitely.

Unaffected by temperature and impervious to rot and mildew, oil-only absorbents are an ideal choice for outdoor use, in bodies of water or anywhere that water may be inadvertently absorbed.



Liquids absorbed

- Drilling and cutting fluids
- Hydraulic and brake fluids
- Engine oils
- Transmission fluids
- Lubricants
- Gasoline, diesel and aircraft fuels
- Cooking oils
- Oil-based paints and solvents
- Other oils and petroleum-based fluids

Popular applications

- Outdoors
- Around bodies of water
- Wiping tools
- Small spills
- Under leaky pipes
- Around machinery
- Outdoor storage containers
- Under dripping valves
- Other general purpose maintenance

Absorbents



Oil Plus Absorbents

- Perfect for general everyday use and emergency spill clean-up
- Absorbs petroleum-based oils, solvents and other non-water soluble liquids
- Floats indefinitely even when saturated with oil
- 3-ply meltblown polypropylene construction increases durability and reduces lint

Features

- For oils, coolants, solvents and oil-based fluids
- Top and bottom coverstock (3-ply)
- Medium durability
- Medium linting
- Perforated and dimpled
- Floats indefinitely
- Heavy and medium weights
- Cost: \$\$\$

Recommended applications

- Anywhere there is a leak, drip or spill
- Fuel stations and automotive industries
- Precision engineering
- Printing industries



Catalog #	Type	Size	Perforated	Absorbency Factor (gl/gs)	Absorbency Capacity (gal)	Shipping Wt. (lbs)	Pallet Qty.	Quantity
Pads								
OP50	Heavy-weight pad	30 in. x 30 in.	Yes, 15 in.	12.5	41	24	11	50/case
OP150DND	Heavy-weight pad*	15 in. x 19 in.	Yes, 7.5 in.	12.5	39	27	18	150/case
OP100	Heavy-weight pad	15 in. x 19 in.	Yes, 7.5 in.	12.5	26	17.5	30	100/case
OP300	Medium-weight pad	15 in. x 19 in.	Yes, 7.5 in.	12.5	20.5	14	30	100/case
Rolls								
OP30-DP	Heavy-weight roll	30 in. x 150 ft.	Yes, 15 in. and every 15 in.	12.5	49	33	12	1/case
OP30P	Heavy-weight roll	30 in. x 150 ft.	Yes, every 30 in.	12.5	49	33	12	1/case
OP30	Heavy-weight roll	30 in. x 150 ft.	No	12.5	49	33	12	1/case
OP15-DP	Heavy-weight roll	15 in. x 150 ft.	Yes, 7.5 in. and 12 in. across	12.5	24	17.5	24	1/case
OP15P	Heavy-weight roll	15 in. x 150 ft.	Yes, every 18 in.	12.5	24	17.5	24	1/case
OP15	Heavy-weight roll	15 in. x 150 ft.	No	12.5	24	17.5	24	1/case
OP350-DP	Medium-weight roll	30 in. x 150 ft.	Yes, 15 in. and every 15 in.	12.5	38	26.5	12	1/case
OP315P	Medium-weight roll	15 in. x 150 ft.	Yes, every 18 in.	12.5	19	14	24	1/case

*Features Dispense-N-Dispose® System



SPC105 features blue coverstock on one side.

SPC® Oil Absorbents

- Brady SPC's best-selling oil-only pads for industrial or marine use
- Absorbs petroleum-based oils, solvents and other non-water soluble liquids
- Floats indefinitely even when saturated with oil
- Efficient single-ply construction of MAXX® absorbent technology — absorption and strength without the extra weight
- Packaged in a blue bag to streamline absorbent identification in your facility

Features

- For oils, coolants, solvents and oil-based fluids
- No coverstock (1-ply)
- Medium durability
- Medium linting
- Perforated and dimpled
- Floats indefinitely
- Heavy, medium and light weights
- Cost: \$\$

Recommended applications

- Anywhere there is a leak, spill or drip
- Marine and environmental spills
- Oil refineries / fuel chemical
- General manufacturing

Catalog #	Type	Size	Perforated	Absorbency Factor (gl/gs)	Absorbency Capacity (gal)	Shipping Wt. (lbs)	Pallet Qty.	Quantity
Pads								
SPC50	Heavy-weight pad	33 in. x 39 in.	No	18	73	33.5	10	50/bale*
SPC100	Heavy-weight pad	15 in. x 19 in.	Yes, 7.5 in.	18	35	14	30	100/bale*
SPC105	Heavy-weight pad (1 side w/blue coverstock)	15 in. x 19 in.	Yes, 7.5 in.	18	24	14	30	100/bale*
SPC300	Medium-weight pad	15 in. x 19 in.	Yes, 7.5 in.	18	30	11	30	100/bale*
SPC200	Light-weight pad	15 in. x 19 in.	Yes, 7.5 in.	18	51	16	24	200/bale*
SPC500	Light-weight pad	15 in. x 19 in.	Yes, 7.5 in.	18	20	8.2	36	100/bale*
Rolls								
SPC150	Heavy-weight roll	38 in. x 144 ft.	No	15	70	33	18	1/bale*
SPC152	Heavy-weight roll	19 in. x 144 ft.	No	15	70	33	18	2/bale*

*SPC Oil Absorbents packaged in a blue bag.



BASIC Oil Absorbents

- Value-priced oil-only absorbent
- Absorbs petroleum-based oils, solvents and other non-water soluble liquids
- Floats indefinitely even when saturated with oil
- Economical single-ply pads and rolls made of oil-only meltblown polypropylene
- Packaged in a clear bag to streamline absorbent identification in your facility

Features

- For oils, coolants, solvents and oil-based fluids
- No coverstock (1-ply)
- Light durability
- High linting
- Perforated and dimpled
- Floats indefinitely
- Heavy and light weights
- Cost: \$

Recommended applications

- Anywhere there is a leak, spill or drip
- General industrial or manufacturing oil-only applications
- Marine and environmental spills
- Coast guard or on-board vessels

Catalog #	Type	Size	Perforated	Absorbency Factor (gl/gs)	Absorbency Capacity (gal)	Shipping Wt. (lbs)	Pallet Qty.	Quantity
Pads								
BPO100	Heavy-weight pad	15 in. x 17 in.	Yes, 7.5 in.	18	20.5	8.5	30	100/bale*
BPO200	Light-weight pad	15 in. x 17 in.	Yes, 7.5 in.	18	34	14	24	200/bale*
BPO500	Light-weight pad	15 in. x 17 in.	Yes, 7.5 in.	18	17	7	36	100/bale*
Rolls								
BRO150	Heavy-weight roll	30 in. x 150 ft.	Yes, every 30 in.	14.5	38	19.5	18	1/bale*
BRO152	Heavy-weight split roll	15 in. x 150 ft.	Yes, every 30 in.	14.5	38	19.5	18	2/bale*

*BASIC Oil Absorbents packaged in a clear bag.

Oil-Only Absorbency

BradyID.com/s36



SXT® Oil-Only Absorbents

- Ideal absorbent when durability, abrasion resistance and low linting are required
- Floats indefinitely even when saturated with oil
- Durable 3-ply meltblown polypropylene construction with abrasion-resistant top and bottom coverstock layers
- Extra strength allows for wringing and re-use

Features

- For oils, coolants, solvents and oil-based fluids
- Top and bottom coverstock (3-ply)
- High durability and low linting
- Floats indefinitely
- Perforated and dimpled
- Heavy, medium and light weights
- Cost: \$ \$ \$

Catalog #	Type	Size	Perforated	Absorbency Factor (gl/gs)	Absorbency Capacity (gal)	Shipping Wt. (lbs)	Pallet Qty.	Quantity
Pads								
SXT100	Heavy-weight pad	15 in. x 19 in.	Yes, 7.5 in.	12	19.5	14.5	30	100/case
SXT300	Medium-weight pad	15 in. x 19 in.	Yes, 7.5 in.	12	17	10	30	100/case
SXT200	Light-weight pad	15 in. x 19 in.	Yes, 7.5 in.	12	31.5	18	22	200/case
Rolls								
SXT30DP	Heavy-weight roll	30 in. x 150 ft.	Yes, 15 in. and every 15 in.	12	37	26.5	12	1/case
SXT15P	Heavy-weight roll	15 in. x 150 ft.	Yes, every 18 in.	12	18	14	24	1/case



ENV® Oil Absorbents

- Highly economical, contractor-grade absorbent for oil clean-up on land or water
- Floats indefinitely even when saturated with oil
- Efficient single-ply of MAXX® Technology — absorption and strength without the extra weight
- Packaged in a green bag to streamline absorbent identification in your facility

Features

- For oils, coolants, solvents and oil-based fluids
- No coverstock (1-ply)
- Light durability and high linting
- Floats indefinitely
- Non-dimpled for max surface absorption area
- Heavy, medium and light weights
- Cost: \$

Catalog #	Type	Size	Perforated	Absorbency Factor (gl/gs)	Absorbency Capacity (gal)	Shipping Wt. (lbs)	Pallet Qty.	Quantity
Pads								
ENV50	Medium-weight pad	30 in. x 30 in.	No	20	50	19	14	50/bale*
ENV100	Heavy-weight pad	15 in. x 19 in.	No	20	33	12.5	30	100/bale*
ENV300	Medium-weight pad	15 in. x 19 in.	No	18	23.2	10	30	100/bale*
ENV200	Light-weight pad	15 in. x 19 in.	No	23	51	16	24	200/bale*
ENV500	Light-weight pad	15 in. x 19 in.	No	23	24.5	8	30	100/bale*
MXO1000	Light-weight pad	15 in. x 19 in.	Yes, 7.5 in.	23	26	8	30	100/case
Rolls								
ENV150	Medium-weight roll	30 in. x 150 ft.	No	15	44	22	18	1/bale*

*ENV Oil Absorbents packaged in a green bag.



Static Resistant Oil Absorbents

- Oil-only absorbents specially treated to resist static electricity build up around flammable liquid or delicate electronics
- Oil-only absorbency for petroleum-based oils, solvents and other non-water soluble liquids — making it idea for outdoor use
- Economical single-ply pads and rolls made of oil-only meltblown polypropylene
- Meets National Fire Protection Association specifications

Features

- For oils, coolants, solvents and oil-based fluids
- No coverstock (1-ply)
- Light durability and high linting
- Non-dimpled for max surface absorption area
- Heavy weights
- Cost: \$ \$ \$

Catalog #	Type	Size	Perforated	Absorbency Factor (gl/gs)	Absorbency Capacity (gal)	Shipping Wt. (lbs)	Pallet Qty.	Quantity
Pads								
SR3625	Heavy-weight pad	30 in. x 30 in.	No	13	16	9	14	25/bale
SR100	Heavy-weight pad	15 in. x 19 in.	No	13	26	14.5	30	100/bale
Rolls								
SR3600	Heavy-weight roll	30 in. x 150 ft.	No	15	44	22	18	1/bale

Absorbents



Spill Response Plus Oil Absorbents

- Convenient, portable size that's perfect for employees to fold or carry in their pockets for small spills
- Floats indefinitely even when saturated with oil
- Fine fiber coverstock on each side increases product versatility
- Small size to clean up of minor spills without wasting material

Features

- For oils, coolants, solvents and oil-based fluids
- Top and bottom coverstock (3-ply)
- Medium durability and medium linting
- Perforated and dimpled
- Heavy weights
- Cost: \$ \$

Catalog #	Type	Size	Perforated	Absorbency Factor (g/g)	Absorbency Capacity (gal)	Shipping Wt. (lbs)	Pallet Qty.	Quantity
Pads								
SRPO100	Heavy-weight pad	7.5 in. x 10 in.	No	12.5	5.5	4	96	100/case
SRPO200	Heavy-weight pad	7.5 in. x 10 in.	No	12.5	11.1	7.5	48	200/case
Rolls								
SRPO75P	Heavy-weight roll	7.5 in. x 50 ft.	Yes, 10 in.	12.5	3.3	1.85	60	1/bale



Re-Form™ Oil-Only Absorbents

- Eco-friendly oil-only absorbent offering superior absorbency — absorbs more than 30 times its weight
- Floats indefinitely even when saturated with oil
- 3-ply construction with top and bottom coverstock, all made from 80% natural cellulose fibers
- Supports corporate sustainability and LEED initiatives
- Class A fire retardant

Features

- For oils, coolants, solvents, oil-based fluids and non-aggressive chemicals
- Top and bottom coverstock (3-ply)
- Medium durability and low linting
- Perforated
- Heavy weight
- Cost: \$ \$ \$

Catalog #	Type	Size	Perforated	Absorbency Factor (g/g)	Absorbency Capacity (gal)	Shipping Wt. (lbs)	Pallet Qty.	Quantity
Pads								
RFODP100	Heavy-weight pad	15 in. x 19 in.	Yes, 7.5 in.	30	39	12	18	100/case

Re-Form Absorbents are not intended for use with highly aggressive chemicals.

Suitable for outdoor storage

Oil-only absorbents are specifically designed to repel water, which means they can be stored outdoors and will not be affected by the weather, fluctuating outdoor temperatures or moisture.



Chemical Absorbency

BradyID.com/s36

Chemical Absorbency

Color coded for when chemical-based fluids are present

Alert your employees to the presence of hazardous fluids with green and yellow chemical absorbents from Brady SPC. These surfactant-treated polypropylene pads and rolls can be used on a wide range of chemicals and are chemically inert, so they will not react with aggressive fluids.



Liquids absorbed

- Acids and bases
- Aggressive chemicals
- Sodium hydroxide
- Solvents
- Citric acid
- Water-based fluids
- Oil-based fluids
- Other unknown chemicals

Popular applications

- Anywhere hazardous chemicals may be present
- Bulk chemical storage containers
- Nuclear power plants
- Laboratories
- Hospitals
- Pharmaceuticals and any industry utilizing chemicals
- Chemical manufacturing
- To recognize chemical waste stream

Absorbents

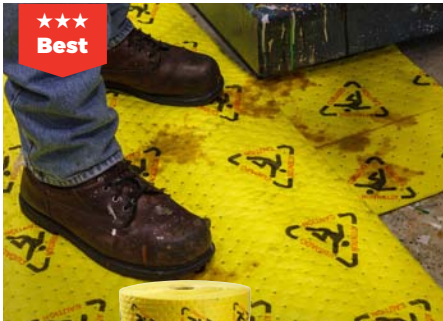

BRIGHTSORB® High-Visibility Safety Absorbents

- Safety color and print make it ideal for areas where the risk of slips, trips and falls is greatest
- Chemical absorbency for areas where chemicals may be present
- Product will not react with aggressive fluids
- 2-ply construction increases durability and reduces lint
- Printed safety message warns of slip, trip and fall hazards
- Bright color warns of presence of leaks, drips or spills even in low light

Features

- Absorbs acids, bases, oils, chemicals, solvents, water-based fluids, unknown chemicals
- Safety printed top coverstock (2-ply)
- Medium durability
- Low linting
- Perforated and dimpled
- Heavy, medium and light weights
- Cost: \$\$\$

Recommended applications

- Areas with slip, trip and fall hazards
- Foot traffic areas
- Drips and spills involving hazardous chemicals
- Any industrial application utilizing aggressive fluids

Catalog #	Type	Size	Perforated	Absorbency Factor (gl/gs)	Absorbency Capacity (gal)	Shipping Wt. (lbs)	Pallet Qty.	Quantity
Pads								
CH100	Heavy-weight pad	15 in. x 19 in.	Yes, 7.5 in.	18	28	16	30	100/case
CH1212	Medium-weight pad*	12 in. x 12 in.	Yes, 6 in.	12.5	30	14.5	30	200/case
CH1212-50	Medium-weight pad*	12 in. x 12 in.	Yes, 6 in.	12.5	7.5	4	72	50/case
CH200	Light-weight pad	15 in. x 19 in.	Yes, 7.5 in.	18	28	16	22	200/case
Rolls								
CH30DP	Heavy-weight roll	30 in. x 150 ft.	Yes, 15 in. and every 15 in.	12.5	40	25	12	1/case
CH15P	Heavy-weight roll	15 in. x 150 ft.	Yes, every 18 in.	12.5	20	14	24	1/case
CH303	Medium-weight roll	30 in. x 300 ft.	Yes, 15 in. and every 15 in.	12.5	70	40	8	1/bale

* Absorbent does not have print.



Universal Plus Chemical Absorbents

- Durable chemical absorbents for wiping, drips, spills and leaks that may involve hazardous chemicals.
- Product will not react with aggressive fluids
- Highly durable 3-ply construction reduces lint
- Bright color warns of presence of chemicals for proper disposal

Features

- Absorbs acids, bases, oils, chemicals, solvents, water-based fluids, unknown chemicals
- Top and bottom coverstock (3-ply)
- Medium durability
- Medium linting
- Perforated and dimpled
- Medium weight
- Cost: \$ \$ \$

Catalog #	Type	Size	Perforated	Absorbency Factor (gl/g)	Absorbency Capacity (gal)	Shipping Wt. (lbs)	Pallet Qty.	Quantity
Pads								
SPCUN1719	Medium-weight pad	15 in. x 19 in.	Yes, 7.5 in.	12.5	20.5	14.5	30	100/case
SPCUN1113	Medium-weight pad	12 in. x 12 in.	No	12.5	20	16	30	200/case
Rolls								
SPCUN3800	Medium-weight roll	30 in. x 150 ft.	Yes, 15 in. and every 15 in.	12.5	39	27	12	1/case
SPCUN1019	Medium-weight roll	15 in. x 150 ft.	Yes, 15 in. and every 15 in.	12.5	39	24	12	2/case



BASIC Chemical Absorbents

- Economical absorbents for drips, spills and leaks that may involve chemicals
- Product will not react with aggressive fluids
- Economical single-ply construction
- Bright color warns of presence of chemicals for proper disposal

Features

- Absorbs acids, bases, oils, chemicals, solvents, water-based fluids, unknown chemicals
- No coverstock (1-ply)
- Light durability
- High linting
- Perforated and dimpled
- Heavy and light weights
- Cost: \$

Catalog #	Type	Size	Perforated	Absorbency Factor (gl/g)	Absorbency Capacity (gal)	Shipping Wt. (lbs)	Pallet Qty.	Quantity
Pads								
BPH100	Heavy-weight pad	15 in. x 17 in.	Yes, 7.5 in.	18	20	8.5	30	100/bale
BPH200	Light-weight pad	15 in. x 17 in.	Yes, 7.5 in.	18	34	13.7	24	200/bale
BPH500	Light-weight pad	15 in. x 17 in.	Yes, 7.5 in.	18	17	7	36	100/bale
Rolls								
BRH150	Heavy-weight roll	30 in. x 150 ft.	Yes, every 30 in.	18	38	19.5	18	1/bale
BRH152	Heavy-weight split roll	15 in. x 150 ft.	Yes, every 30 in.	18	38	19.5	18	2/bale



Spill Response Plus Universal Plus Absorbents

- Convenient, portable size perfect for employees to fold or carry in their pockets
- Product will not react with aggressive fluids
- Fine fiber coverstock on each side increases product versatility
- Bright color warns of presence of chemicals for proper disposal
- Small size to clean up minor spills without wasting material

Features

- Absorbs acids, bases, oils, chemicals, solvents, water-based fluids, unknown chemicals
- Top and bottom coverstock (3-ply)
- Medium durability
- Medium linting
- Perforated and dimpled
- Heavy weight
- Cost: \$ \$

Catalog #	Type	Size	Perforated	Absorbency Factor (gl/g)	Absorbency Capacity (gal)	Shipping Wt. (lbs)	Pallet Qty.	Quantity
Pads								
SRPH100	Heavy-weight pad	7.5 in. x 10 in.	No	12.5	5.5	4	96	100/case
SRPH200	Heavy-weight pad	7.5 in. x 10 in.	No	12.5	11.1	7.5	48	200/case
Rolls								
SRPH75P	Heavy-weight roll	7.5 in. x 50 ft.	Yes, 10 in.	12.5	3.3	1.85	60	1/bale

Mats and Rugs

BradyID.com/s36

Mats and Rugs For foot and forklift traffic

Brady SPC absorbent mats and rugs keep aisles and walkways slip-free by absorbing and containing oils, liquids or other spills. They are designed to hold up under the toughest conditions and are ideal for high-traffic areas and workstations. Compared to an entrance mat, absorbent mats and rugs offer better traction and reduce the tracking of liquids from one area to another.

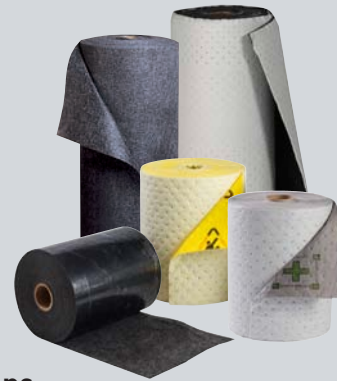

Liquids absorbed

- Bases and oils
- Chemicals
- Solvents
- Water-based fluids

Popular applications

- Heavy foot traffic
- Aisles and walkways
- Around workstations
- To reduce tracking liquids throughout facility

Absorbents



TOUGHSORB™ Permanent and Semi-Permanent Adhesive Mats

- Easy adherence for high-traffic aisles and walkways
- Universal absorbency to handle most fluids (water, petroleum and chemical-based)
- Strong needle-punched polypropylene with an adhesive backing
- Permanent or semi-permanent adhesive backing adheres to surfaces to keep the absorbent in place and reduce slips, trips and falls



Permanent adhesive mat is protected by a clear liner that must be removed prior to use.

Semi-permanent adhesive mat can be applied and removed as needed making it ideal for work surfaces.

Features

- For oils, coolants, solvents and water-based fluids
- Adhesive backing (2-ply)
- High durability
- Low linting
- Heavy and medium weight
- Cost: \$ \$ \$

Recommended applications

- Aisles and walkways
- Areas with high foot and forklift traffic
- Lining entrances and exits
- Lining tool cribs and work surfaces

Catalog #	Type	Size	Perforated	Absorbency Factor (gl/gs)	Absorbency Capacity (gal)	Shipping Wt. (lbs)	Pallet Qty.	Quantity
Permanent adhesive adhesive								
AD30100	Heavy-weight roll	30 in. x 100 ft.	No	8	21	29	20	1/case
AD15100	Heavy-weight roll	15 in. x 100 ft.	No	8	11	15	40	1/case
Semi-permanent adhesive								
AD30100-BLUE	Medium-weight roll	30 in. x 100 ft.	No	8	21	29	20	1/case
AD15100-BLUE	Medium-weight roll	15 in. x 100 ft.	No	8	11	15	40	1/case

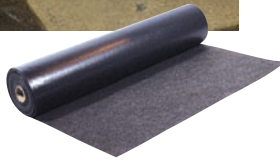
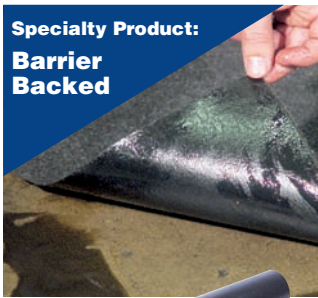

Barrier Spill Mat (BSM)

- Industrial rug with non-slip and leak-proof barrier backing for use in high-traffic areas and around workstations
- Universal absorbency to handle most fluids (water, petroleum and chemical-based)
- Strong needle-punched polypropylene with a non-skid backing
- Durable for high traffic areas and helps eliminate slippery areas and unsightly tracking
- Tear-resistant and will not curl or buckle
- Non-skid barrier backing prevents liquid from reaching the floor underneath while tacky underside reduces slips, trips and falls
- Gray color masks spills reducing the urge to replace absorbents before fully saturated

Features

- For oils, coolants, solvents and water-based fluids
- Non-skid backing (2-ply)
- High durability
- Low linting
- Medium weight
- Cost: \$ \$ \$

Recommended applications

- Ideal for high-traffic industrial applications and in workstations
- Premium surface protection during renovation work

Catalog #	Type	Size	Perforated	Absorbency Factor (gl/g)	Absorbency Capacity (gal)	Shipping Wt. (lbs)	Pallet Qty.	Quantity
Rolls								
BSM100	Medium-weight rug	36 in. x 100 ft.	No	8	25	24	20	1/bale

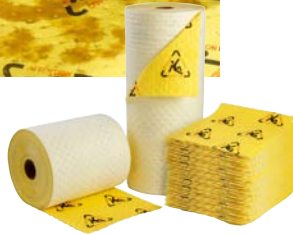

BRIGHTSORB® High-Visibility Barrier-Backed Mat

- Absorbency, signage and durability all in one
- Universal absorbency to handle most fluids (water, petroleum and chemical based).
- Product will not react with aggressive fluids
- Non-skid, barrier-backed 3-ply construction with spunbond coverstock for durability
- Barrier backing prevents liquid from reaching the floor underneath
- Printed safety message warns of slips, trips and falls
- Brightly color-coded for safety and easy separation of hazardous waste

Features

- For oils, coolants, solvents and water-based fluids
- Safety-printed coverstock and barrier backing (3-ply)
- High durability
- Low linting
- Heavy weight
- Cost: \$ \$ \$

Recommended applications

- Areas with low visibility
- Lining aisles and walkways
- High-traffic areas prone to leaks, drips and spills

Catalog #	Type	Size	Perforated	Absorbency Factor (gl/g)	Absorbency Capacity (gal)	Shipping Wt. (lbs)	Pallet Qty.	Quantity
Pads								
CHBB100	Heavy-weight pad	15 in. x 19 in.	No	11.7	21	15.8	30	100/case
Rolls								
CHBB30	Heavy-weight roll	30 in. x 100 ft.	No	11.7	27	22	12	1/bale
CHBB15	Heavy-weight roll	15 in. x 100 ft.	No	11.7	13	11	24	1/bale

Need to know OSHA regulation

29 CFR 1910.22(a)(2) – Walking-Working Surfaces

The floor of every workroom shall be maintained in a clean and, so far as possible, dry condition. Where wet processes are used, drainage shall be maintained, and false floors, platforms, mats, or other dry standing places should be provided where practicable.

Mats and Rugs

BradyID.com/s36

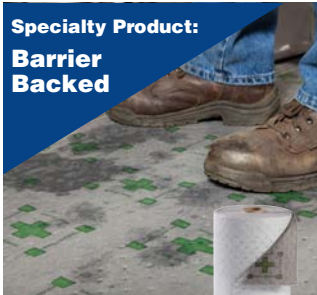

High-Traffic (HT) Barrier-Backed Mat

- Universal absorbent with added durability to stand up to the toughest conditions
- Universal absorbency to handle most fluids (water, petroleum and chemical-based)
- Non-skid, barrier-backed 3-ply construction with spunbond coverstock for durability
- Printed safety message reminds workers to use caution near high-risk slip, trip and fall areas
- Barrier backing prevents liquid from reaching the floor underneath
- Gray color masks spills, reducing the urge to replace them before they are fully saturated

Features

- For oils, coolants, solvents and water-based fluids
- Safety-printed coverstock and barrier backing (3-ply)
- High durability
- Low linting
- Heavy weight
- Cost: \$ \$ \$

Recommended applications

- Aisles and walkways
- High-traffic areas prone to leaks, drips and spills
- Areas where a subtle safety messaging is desired

Catalog #	Type	Size	Perforated	Absorbency Factor (gl/gs)	Absorbency Capacity (gal)	Shipping Wt. (lbs)	Pallet Qty.	Quantity
Pads								
HTBB100	Heavy-weight pad	15 in. x 19 in.	No	10.1	18	14.8	30	100/case
Rolls								
HTBB30	Heavy-weight roll	30 in. x 100 ft.	No	10.1	23	20	12	1/bale
HTBB15	Heavy-weight roll	15 in. x 100 ft.	No	10.1	12	10	24	1/bale

Absorbents



TrackMat Matting

- The ultimate barrier absorbent for high-volume petroleum spills
- Universal absorbency to handle most fluids (water, petroleum and chemical based)
- Extremely durable absorbent with UV-resistant top layer makes it ideal for outdoor use
- Non-slip barrier backing prevents liquids from penetrating into the ground
- Dimples add durability and reduce linting

Features

- For oils, coolants, solvents and water-based fluids
- Non-slip barrier backing (2-ply)
- High durability
- Low linting
- Heavy weight
- Cost: \$ \$ \$

Recommended applications

- Where strength, absorbency and impermeability are needed
- Transportation companies
- Refineries and steel mills
- Railway or military

Catalog #	Type	Size	Perforated	Absorbency Factor (gl/gs)	Absorbency Capacity (gal)	Shipping Wt. (lbs)	Pallet Qty.	Quantity
Rolls								
TM58	Heavy-weight roll	58 in. x 80 ft.	No	9	55	34	9	1/bale
TM29	Heavy-weight roll	29 in. x 80 ft.	No	9	20	24	18	1/bale
TM19	Heavy-weight roll	19 in. x 80 ft.	No	9	26	32	18	2/bale



Sorbent Industrial Rug (SIR)

- Designed for moderate traffic areas and workstations where there's a need for clean and safe work floors and walkways
- Universal absorbency to handle most fluids (water, petroleum and chemical-based)
- Durable, needle-punched polypropylene fibers for moderate traffic areas (1-ply)
- Eliminates slippery areas and unsightly tracking between the plant and office areas
- Gray color masks spills reducing the urge to replace absorbents before fully saturated

Features

- For oils, coolants, solvents and water-based fluids
- Needle-punched polypropylene (1-ply)
- High durability
- Low linting
- Heavy weight
- Cost: \$\$

Recommended applications

- Vehicles repair and service
- Warehouse and container terminal
- Surface protection during renovation
- Marine spills/wildlife preservation

Catalog #	Type	Size	Perforated	Absorbency Factor (gl/gs)	Absorbency Capacity (gal)	Shipping Wt. (lbs)	Pallet Qty.	Quantity
Rolls								
SIR36	Heavy-weight rug	36 in. x 300 ft.	No	12.5	59	50	12	1/bale
SIR36150	Heavy-weight rug	36 in. x 150 ft.	No	12.5	29.5	25	18	1/bale



Rag Rug Matting

- Eco-friendly absorbent matting made from recycled cotton and polyester fibers
- Universal absorbency to handle most fluids (water-based and petroleum-based)
- Economy rug provides good footing, masks dirt and absorbs spills
- Ideal for maintenance, repair and industrial environments
- Eco-friendly construction supports corporate sustainability and Leadership in Energy and Environmental Design (LEED) initiatives

Features

- For oils, coolants, solvents and water-based fluids
- Recycled fibers (1-ply)
- Medium durability
- High linting
- Heavy weight
- Cost: \$

Recommended applications

- Ideal for high-traffic industrial applications and in workstations
- Premium surface protection during renovation work

Catalog #	Type	Size	Perforated	Absorbency Factor (gl/gs)	Absorbency Capacity (gal)	Shipping Wt. (lbs)	Pallet Qty.	Quantity
Pads								
RAG1818	Heavy-weight pads	18 in. x 18 in.	No	9	38	32	24	50/case
Rolls								
RAG36150	Heavy-weight rug	36 in. x 150 ft.	No	9	55	47	6	1/bale
RAG24150	Heavy-weight rug	24 in. x 150 ft.	No	9	37	52	12	1/bale

SOCs, Pillows and Drum Covers

BradyID.com/s36

Universal SOC

- All-purpose SOC to clean up oils, coolants, solvents and water-based fluids throughout your facility
- Gray color masks spills and stains — helping you resist the urge to pick up the absorbent before it is fully saturated

Catalog #	Type	Size	Absorbency Factor (gl/g)	Absorbency Capacity (gal)	Shipping Wt. (lbs)	Pallet Qty.	Quantity
ALLWIK Universal							
AW124	SOC	3 in. x 12 ft.	9	12	12	40	4/case
AW806	SOC	3 in. x 8 ft.	9	12	12	30	6/case
AW430	SOC	3 in. x 4 ft.	9	30	26	15	30/case
AW412	SOC	3 in. x 4 ft.	9	12	12	36	12/case
SLIKWIK Universal							
SW46	SOC	3 in. x 3.5 ft.	3	20	50	16	40/case
Cobra Coil Universal							
CC400	SOC	3 in. x 4 ft.	8.5	8.5	29	48	12/case
BASIC Universal							
BSC40	SOC	3 in. x 3.5 ft.	15	84	47.5	12	40/case
BSC20	SOC	3 in. x 3.5 ft.	15	40.5	24	24	20/case
Re-Form Universal							
MS124	SOC	3 in. x 12 ft.	8.5	12	12	36	4/case
MS806	SOC	3 in. x 8 ft.	8.5	12	12	30	6/case
MS50	SOC	3 in. x 4 ft.	7	40	43	10	40/case
MS412	SOC	3 in. x 4 ft.	8.5	12	12	36	12/case
SpillFix Granular							
SF-10BOOM	SOC	4 in. x 10 ft.	4.5	6	20	48	2/case
SF-5BOOM	SOC	4 in. x 5 ft.	4.5	6	16	48	4/case



ALLWIK® Polypropylene SOC



SLIKWIK® Corn Cob SOC



Cobra Coil® Vermiculite SOC



BASIC Cellulose SOC



Re-Form™ Recycled Newsprint SOC



SpillFix® Granular SOC

Oil-Only SOC

- Absorbs oil, grease, transmission fluid, coolant and other petroleum-based liquids
- Repels water and floats for outdoor applications
- Wringable and can be incinerated
- Strong wicking action; absorption begins instantly after contact with the spilled liquid, no need to turn the SOC

Catalog #	Type	Size	Absorbency Factor (gl/g)	Absorbency Capacity (gal)	Shipping Wt. (lbs)	Pallet Qty.	Quantity
Polypropylene Oil Only							
OIL124	SOC	3 in. x 12 ft.	9	12	11	40	4/case
OIL806	SOC	3 in. x 8 ft.	9	12	11	30	6/case
OIL430	SOC	3 in. x 4 ft.	9	28	30	15	30/case
OIL412	SOC	3 in. x 4 ft.	9	12	11	36	12/case
Re-Form Oil Only							
RFO412	SOC	3 in. x 4 ft.	13.5	15	10.5	36	12/case



Oil-only Polypropylene SOC



Re-Form™ Oil-only SOC
(80% all natural cotton fibers)

Chemical SOC

- Absorbs chemicals, acids and bases
- Flexible design is easily molded around spills
- BRIGHTSORB bright yellow color and print help prevent risk of slips, trips and falls

Catalog #	Type	Size	Absorbency Factor (gl/g)	Absorbency Capacity (gal)	Shipping Wt. (lbs)	Pallet Qty.	Quantity
BRIGHTSORB® High-Visibility Chemical							
CH124	SOC	3 in. x 12 ft.	9	12	12	40	4/case
CH412	SOC	3 in. x 4 ft.	9	12	12	36	12/case
HAZWIK Chemical							
HAZ124	SOC	3 in. x 12 ft.	9	12	12	40	4/case
HAZ412	SOC	3 in. x 4 ft.	9	12	12	36	12/case



BRIGHTSORB Polypropylene SOC
with high visibility color and print



HAZWIK® Polypropylene SOC

HandySorb Mop System

- Handle extends up to six feet for areas you can't reach – eliminating the need for kneeling
- Patented quick-release operation for easy disposal
- “No-touch” pads and pillows keep your hands out of the mess
- Refill pads include reusable slide-on adaptor to hook on the pads

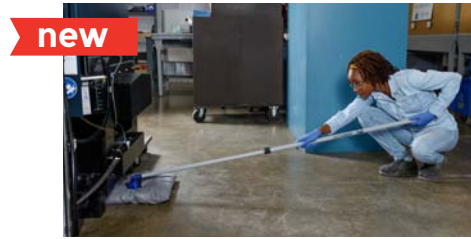

Catalog #	Type	Size	Absorbency Factor (g/g)	Absorbency Capacity (gal)	Quantity
HANDYSORB-MOPKIT	Mop Starter Kit	19 in. x 15 in.	1.5	1.5	1 handle 3 pads
HANDYSORB-NTPAD	“No-Touch” Pads	19 in. x 15 in.	12.5	12.5	25 pads
HANDYSORB-NTPILLOW	“No-Touch” Pillows	18 in. x 18 in.	12.5	28	10 pillows
HANDYSORB-BASICPAD	Refill pads with reusable adaptor	19 in. x 15 in.	11	19.5	1 adaptor 100 pads

Pillows

Absorbent pillows are ideal for use under spill pallets or machines and valves that are known to drip or leak. They are easy to retrieve, and can soak up fluids in hard-to-reach areas including sumps, catch basins and outdoor ponds.

- All-purpose universal pillows are suitable for water-based fluids
- Oil-only pillows absorb petroleum-based liquids while repelling water
- Chemical pillows absorb chemicals, acids and bases and are ideal for extra protection during packaging and transport



Catalog #	Type	Size	Absorbency Factor (g/g)	Absorbency Capacity (gal)	Shipping Wt. (lbs)	Pallet Qty.	Quantity
Universal							
AW1818	Pillow	18 in. x 18 in.	12.5	28	19	15	16/case
AW99	Pillow	9 in. x 9 in.	12.5	14	10	40	32/case
Oil Only							
OIL1818	Pillow	18 in. x 18 in.	12.5	28	19	15	16/case
OIL99	Pillow	9 in. x 9 in.	12.5	14	10	40	32/case
BRIGHTSORB Chemical							
CH1818	Pillow	18 in. x 18 in.	12.5	14	10	15	16/case
HAZWIK Chemical							
HAZ1818	Pillow	18 in. x 18 in.	12.5	28	19	15	16/case
HAZ99	Pillow	9 in. x 9 in.	12.5	14	10	40	32/case



Universal and Oil-Only Drum Covers

- Designed to fit 55-gallon drums — pre-cut holes fit drums with 1 or 2 bungholes
- Create a clean and safe work floor by helping to prevent pump drips from reaching the floor
- Universal absorbs water-, oil- and chemical-based liquids.
Oil-only absorbs oil- and petroleum-based liquids while repelling water



Catalog #	Type	Size	Absorbency Factor (g/g)	Absorbency Capacity (gal)	Shipping Wt. (lbs)	Pallet Qty.	Quantity
DTA25	Universal	22 in. dia.	12.5	6	6	60	25/case
DTO25	Oil only	22 in. dia.	12.5	6	6	60	25/case



Marine Absorbents

BradyID.com/s36

Marine Absorbents

High absorbency on the water

Brady SPC marine absorbents are specially designed to float on water and contain or absorb a wide variety of marine fuels and oils. From containment to booming and skimming operations, these absorbents soak up unwanted fluids on lakes, rivers, streams and coastal shorelines. Marine absorbent products are made for high absorbency and rapid deployment in demanding emergency situations.



Absorbent Booms

Brady SPC absorbent booms are designed to clean up oil spills on water by absorbing surface liquids.

Booms are constructed of highly absorbent polypropylene fibers encased in a durable skin that is lined with a heavy-duty tow rope. The booms are fastened with three stainless steel connectors to allow for linkage and fast deployment in emergency situations, as well as for strength during retrieval or when towing heavy booms saturated with oil.



Premium SPC Oil-Only Booms

- Oil-only booms absorb oil- and petroleum-based liquids while repelling water and floating indefinitely
- Strong, lint-free and gapless
- SPC5510 features two 5 in. x 10 ft. booms attached side by side for a double layer of absorption

Economical ENV® Oil-Only Booms

- Oil-only booms absorb oil- and petroleum-based liquids while repelling water and floating indefinitely
- Features interconnectivity and a lint-free blue sleeve

Universal Plus Chemical Booms

- Universal Plus booms absorb water-, oil- and chemical-based liquids
- Can be deployed indoors or outdoors



Premium SPC Oil Booms



Economical ENV Oil Booms

SPC5510 features booms attached side by side for double absorbency



Universal Plus Chemical Booms

Catalog #	Type	Size	Absorbency Factor (g/g)	Absorbency Capacity (gal)	Shipping Wt. (lbs)	Pallet Qty.	Quantity
Premium SPC® Oil-Only Booms							
SPC810	Boom	8 in. x 10 ft.	13.3	71	40	12	4/bale
SPC510	Boom	5 in. x 10 ft.	12.6	32	19	20	4/bale
SPC5510	Boom*	5 in. x 10 ft.	12.1	32	19	20	4/bale
SPC818	Boom	8 in. x 18 in.	12.5	28	17	16	10/bale
SPC518	Boom	5 in. x 18 in.	12.6	12	8	36	10/bale
Economical ENV Oil-Only Booms							
ENV810	Boom	8 in. x 10 ft.	13	65	38	12	4/bale
ENV510	Boom	5 in. x 10 ft.	12.6	32	19	20	4/bale
Universal Plus Chemical Booms							
SPCUN810	Boom	8 in. x 10 ft.	13.3	71	19	12	4/bale
SPCUN510	Boom	5 in. x 10 ft.	12.6	32	19	20	4/bale

*Features two booms attached side by side for double absorbency

Absorbents

Containment Booms

- Designed to work as a containment barrier in order to keep oil spills on water from spreading
- Ideal for use in holding ponds to retain waste and debris on the surface of the water

Catalog #	Type	Size	Shipping Wt. (lbs)	Pallet Qty.	Quantity
CB612	Boom	6 in. float, 12 in. skirt, 100 ft. sections	200	3	1/case
CB305	Boom	3 in. float, 4.5 in. skirt, 25 ft. sections	22.5	11	1/case



Designed as a containment barrier to prevent spills from spreading

Sweeps and Pillows

- Sweeps feature a 2-ply construction with durable blue coverstock for extra strength (for use with oil- and petroleum-based fluids)
- Help skimming operations by effectively removing surface oil from the water
- 100 ft. sections are ideal for dragging behind or connecting between two ships

Catalog #	Type	Size	Absorbency Factor (gl/gs)	Absorbency Capacity (gal)	Shipping Wt. (lbs)	Pallet Qty.	Quantity
SPC1900	Sweep	19 in. x 100 ft.	15	26	13	30	1/bale
SPC10	Pillow	14 in. x 25 in.	12.5	52	30	10	10/bale



Oil Nets and Drag Nets

- Flat, chemical-resistant filaments in half-pound units float in water and trap heavy oil
- Reusable after draining or dousing with #1 or #2 weight oils; extracted oil can be recycled or downgraded as fuel oil
- Use as a sweep between boats or deployed along a shoreline

Catalog #	Type	Size	Absorbency Factor (gl/gs)	Absorbency Capacity (gal)	Shipping Wt. (lbs)	Pallet Qty.	Quantity
ODN08	Oil only	30 nets on 50 ft. rope	15	15	16	24	1/bale
ON030	Oil only	30 nets (no rope)	15	15	17	24	1/bale



ODN08



ON030
(no rope)

Granular and Neutralizers

BradyID.com/s36

Granular and Neutralizers

Loose, multi-purpose absorbents

Granular absorbents are loose, multi-purpose absorbents used for liquid spill clean-up, lab packing and stabilization of free liquids. This option is ideal for facilities that prefer or require the use of traditional granular absorbents.

The small, loose particles of a granular absorbent make it ideal for applications where a pad or roll would not offer a proper fit. In instances where a liquid spills on a rough surface, a granular absorbent can absorb liquids from the cracks and crevices.

Need to know

OSHA silica ruling:

One of the most common compositions for granular absorbents is diatomaceous earth, which is 80-90% silica based.

OSHA's final rule on limiting exposure to respirable crystalline silica was issued in 2016 to curb lung cancer, silicosis, chronic obstructive pulmonary disease and kidney disease. All of which have been linked to high levels of silica.

SpillFix® Granular Absorbent

The new standard in loose absorbents

- Completely natural — no carcinogens, no dust indoors; landfill and incinerator safe outdoors
- Highly effective — absorbs hydrocarbons, chemicals and water-based solutions
- Workplace friendly — natural construction prevents damage to equipment or floors; a regular occurrence with clay-based granulars
- Deploy indoors or outdoors to clean up spills in hard to reach areas



SpillFix granular absorbs 4 times the liquid of traditional clay granulars

SpillFix Granular Absorbent

- Premium absorbent solution constructed of 100% recycled material
- Lightweight and easy to deploy

Catalog #	Type	Size	Absorbency Factor (g/g)	Absorbency Capacity (gal)	Shipping Wt. (lbs)	Pallet Qty.	Quantity
SF-20	20 lb bag	20 lbs	4.5	7	995	48	1 pallet
SF-7	7 lb bag	7 lbs	4.5	2	900	124	1 pallet
SF-JAR	3 qt. jar (pallet)	3 qt.	4	0.75	365	288	1 pallet
SF-JAR-CS	3 qt. jar (case)	3 qt.	4	0.75	7	-	6/case



SpillFix Granular Boom

- The benefits of SpillFix granular contained in a biodegradable sleeve
- Wringable for added life

Catalog #	Type	Size	Absorbency Factor (g/g)	Absorbency Capacity (gal)	Shipping Wt. (lbs)	Pallet Qty.	Quantity
SF-10BOOM	Boom	4 in. x 10 ft.	4.5	6	20	48	2/case
SF-5BOOM	Boom	4 in. x 5 ft.	4.5	6	16	48	4/case



Re-Form™ Granular

- 100% recycled material — safe for the environment and employee use
- Absorbs oils, solvents, lubricants, coolants, water and most non-aggressive liquids on contact
- 1:1 absorbency ratio — absorbs its own weight in oil

Catalog #	Type	Size	Absorbency Factor (gl/g)	Absorbency Capacity (gal)	Shipping Wt. (lbs)	Pallet Qty.	Quantity
RFGRANULAR	Re-Form granular	30 lbs	1	16.7	1,950	65	1 pallet



SPC Granular Absorbent

- All natural corn cob product for oil, grease, water and other liquids (Not for use with aggressive fluids)
- Ideal for use in aircraft maintenance, machine shops, food processing, filling lines and bulk liquid transfer stations

Catalog #	Type	Size	Absorbency Factor (gl/g)	Absorbency Capacity (gal)	Shipping Wt. (lbs)	Pallet Qty.	Quantity
DZ100	Universal granular	40 lbs	1	8.5	1,600	40	1 pallet



Acid and Base Neutralizing Polymers

- Acid neutralizer provides safe spill control for most acids, including battery spills
- Base neutralizer used for lab equipment and most bases
- Color change lets you know neutralization has taken place; acid neutralizer changes to purple, base neutralizer changes to orange
- Non-toxic, non-corrosive and non-hazardous

Catalog #	Type	Size	Absorbency Factor (gl/g)	Absorbency Capacity (gal)	Shipping Wt. (lbs)	Pallet Qty.	Quantity
SPC-ACID	Acid neutralizer	2 lb	n/a	0.65	2	1200	1/each *
SPC-BASE	Base neutralizer	2 lb	n/a	0.65	2	1200	1/each *

*Minimum order of 12 shakers.



Acid Neutralizer

Base Neutralizer

Absorbents

Try absorbents without a commitment – request a free sample pack today

Making the switch from granular to absorbent pads can be overwhelming. With a Brady SPC sample pack, you can put absorbent pads to the test in your facility without making any commitments.

▶ Request a sample today at BradyID.com/SPC



Absorbents and Spill Control

BradyID.com/s36

Drain Protection

EPA regulations require that facilities prevent fluids from entering the environment. To effectively prevent run-off from reaching storm drains, make sure to have the appropriate drain protection on hand.

Drain Plugs

- Conical-shaped drain plugs made from chemical-resistant PVC keep spills from entering the drainage system and feature a "metal eye" for easy insertion or removal. Then rinse and re-use when finished.

Catalog #	Type	Size	Shipping Wt. (lbs)	Pallet Qty.	Quantity
PLUG6	Drain plug	6 in.	6	50	1/case
PLUG4	Drain plug	4 in.	4	50	1/case
PLUG3	Drain plug	3 in.	3	50	1/case
PLUG2	Drain plug	2 in.	2	50	1/case



Drain Seals

- Resists water, oil and most aggressive fluids
- Easy application; soap and water clean up for re-use
- SLIKSTOPPER drain seals are made from flexible, chemical resistant PVC and help prevent spills from flowing into drainage systems
- Spill Magnet Seals are backed with a strong magnet to tightly seal drains

Catalog #	Type	Size	Shipping Wt. (lbs)	Pallet Qty.	Quantity
PVC42	Slikstopper	42 in. x 42 in.	46	20	1/case
PVC36	Slikstopper	36 in. x 36 in.	34	35	1/case
PVC24	Slikstopper	24 in. x 24 in.	14	40	1/case
PVC18	Slikstopper	18 in. x 18 in.	9	80	1/case
96229	Spill Magnet	12 in. dia.	1	100	1/each



SLIKSTOPPER
PVC Drain Seal



Spill Magnet™
Drain Seal

Storm Drain Guards

- Non-woven polypropylene drain guards keep oil, sediment and contaminants from entering the water system
- Holds up to 40 lbs of sediment; flow rate is 500 gpm new and 700 gpm bypass
- Select drain guards feature X-TEX filter strips which increase absorbency

Catalog #	Type	Size	Absorbency Capacity (gal)	Shipping Wt. (lbs)	Pallet Qty.	Quantity
DGUARD14	Drain guard w/ X-TEX filter strips	36 in. x 48 in. x 18 in.	1.4	2	36	1/case
DGUARD1410	Drain guard w/ X-TEX filter strips	36 in. x 48 in. x 18 in.	14	20	20	10/case
DGUARD9	Drain guard	36 in. x 48 in. x 18 in.	0.9	1	36	1/case
DGUARD910	Drain guard	36 in. x 48 in. x 18 in.	9	10	20	10/case



Drip Pans and Mats

SPC spill containment products are designed with efficiency in mind — keeping your employees and work environment safe from unexpected drum spills or leaks.

Drip Pans

- Durable, low profile, polyethylene drip pans easily fit under leaky drum spigots and other problem areas
- Pan and universal fill captures up to 3/4 of a gallon of liquid

Catalog #	Type	Size	Shipping Wt. (lbs)	Pallet Qty.	Quantity
DPA24	Drip Pan	10 in. x 10 in.	6	20	24/case



Drip Pad

- Provide additional durability to your pads for tougher environments
- 22 oz pad is made of flexible PVC
- 30 oz pad is made of XR5 for additional strength under the toughest conditions
- Grommet included to allow pad to be tied down

Catalog #	Type	Size	Shipping Wt. (lbs)	Pallet Qty.	Quantity
DRIP1720-Y	22 oz pad	17 in. x 20 in.	2	n/a	1/each
DRIP1720-B	30 oz pad	17 in. x 20 in.	2	n/a	1/each



Spill Decks

- Low profile, 21.2-gallon capacity, 2-drum spill decks
- Contain hazardous leaks in your drum storage and dispensing areas
- Built-in clips easily connect multiple decks — creating a 4, 6, 8 or more storage platform

Catalog #	Type	Size	Absorbency Capacity (gal)	Load Cap. (lbs)	Shipping Wt. (lbs)	Pallet Qty.	Quantity
SC-SD2	2-drum spill deck	26 in. x 52 in. x 6 in.	21.2	2,500	31	15	1/each



Spill Pallets

- Comply with governmental secondary containment regulations
- Capacity up to 128 gallons
- 2-drum or 4-drum configuration

Catalog #	Type	Size	Absorbency Capacity (gal)	Load Cap. (lbs)	Shipping Wt. (lbs)	Pallet Qty.	Quantity
SC-DP4	4-drum pallet	52 in. x 52 in. x 17 in.	128	2,200	89	10	1/each
SC-DP2	2-drum pallet	26 in. x 52 in. x 17 in.	68	1,100	46.5	10	1/each
SC-DPR	Pallet ramp	32.5 in. x 70 in.	n/a	650	47.5	3	1/each



Easy loading ramp (sold separately) works with both the 2-drum and 4-drum spill pallets.



Absorbents and Spill Control

BradyID.com/s36

Spill Berms

These collapsible secondary containment berms can be used to contain spills and leaks from vehicles, machinery, tanks, drums and other industrial equipment.

Foam Side Wall Berm

- Portable, lightweight, flexible — folds up for storage and transport
- Re-useable berm is easy to clean and maintain
- Requires no assembly, tools or inflation — unfold and use immediately

Catalog #	Type	Size	Absorbency Capacity (gal)	Shipping Wt. (lbs)	Quantity
FW181804-Y	Foam berm	18 in. x 18 in. x 4 in.	5	2	1/each
FW242404-Y	Foam berm	24 in. x 24 in. x 4 in.	9	2.4	1/each
FW363604-Y	Foam berm	36 in. x 36 in. x 4 in.	20	3.8	1/each
FW484804-Y	Foam berm	48 in. x 48 in. x 4 in.	36	5.5	1/each
FW486004-Y	Foam berm	48 in. x 60 in. x 4 in.	45	6.4	1/each
FW487204-Y	Foam berm	48 in. x 72 in. x 4 in.	54	7.4	1/each



L-ROD Berm

- Fully collapsible and can be rapidly deployed
- RF welded construction made of chemical- and hydrocarbon-resistant polyester
- Aluminum L-rods support the berm walls, but are easily folded to allow for entry/exit of vehicles or machinery
- Re-useable berm is easy to clean and maintain

Catalog #	Type	Size	Absorbency Capacity (gal)	Shipping Wt. (lbs)	Quantity
LROD101012	L-ROD berm	10 ft. x 10 ft. x 1 ft.	675	42	1/each
LROD101512	L-ROD berm	10 ft. x 15 ft. x 1 ft.	1,010	57	1/each
LROD102012	L-ROD berm	10 ft. x 20 ft. x 1 ft.	1,350	73	1/each
LROD151512	L-ROD berm	15 ft. x 15 ft. x 1 ft.	1,520	78	1/each
LROD202012	L-ROD berm	20 ft. x 20 ft. x 1 ft.	2,695	125	1/each



Vehicle Spill Berms

- Self-contained berms feature single piece construction for enhanced durability
- Requires no assembly, tools or inflation

Catalog #	Type	Size	Absorbency Capacity (gal)	Shipping Wt. (lbs)	Quantity
SB-1236	Vehicle Spill Berm	12 ft. x 36 ft. x 1 ft.	149	1/each	1/each
SB-1226	Vehicle Spill Berm	12 ft. x 26 ft. x 1 ft.	112	1/each	1/each



Absorbent Storage

Absorbent storage centers help to ensure fast spill response by keeping absorbents close to the point of need when an unplanned spill occurs.

Absorbent Centers

- Use as a deployment station or mobile spill control unit
- Fits up to a 38 inch roll and full bales of pads
- Stack two or three to make a cabinet, hang it on the wall, or place it under your workbench



Catalog #	Type	Size	Shipping Wt. (lbs)	Pallet Qty.	Quantity
SC-3000	Absorbent Center Without Casters	50 in. x 26 in. x 21.5 in.	50	15	1/each
SC-ACC	Accessory Pack	Includes goggles, gloves, disposal bags with ties and an emergency handbook			1 pack
SC-4	Set of 5 casters	-	n/a	n/a	1 pack
SC-MB	Wall Mount	n/a	n/a	n/a	1 each



* Absorbents sold separately.



Set Of Casters



Accessory Pack



Wall Mount

Spill Control Cart

- Steel cart with locking handle (2 keys included)
- Convenient sturdy work surface with top surface 3 inch backstop and one fixed interior shelf
- Spill control cart ships empty. Select a cart fill option designed to maximize space. Fill options include: (100) 15 in. x 19 in. pads, (8) pillows, (5) 3 in. x 4 ft. SOC's, (5) disposal bags, goggles and nitrile gloves

Catalog #	Type	Size	Shipping Wt. (lbs)	Pallet Qty.	Qty.
SC-Cart	Spill control cart	36 in. x 18 in. x 38-3/8 in.	180	1	1/each
SC-Cart-UF	Universal fill	20 in. x 20 in. x 20 in.	31	8	1/each
SC-Cart-OF	Oil-only fill	20 in. x 20 in. x 20 in.	31	8	1/each
SC-Cart-HF	Chemical fill	20 in. x 20 in. x 20 in.	31	8	1/each



* Absorbents sold separately.

Spill Control Cabinet

- Durable construction and keyhole slots for wall hanging with 2 fully adjustable shelves
- Plexiglass window allows for easy content inventory
- Spill control cabinet ships empty. Select a cart fill option designed to maximize space. Fill options include: (50) 15 in. x 19 in. pads, (6) pillows, (4) 3 in. x 4 ft. SOC's, (5) disposal bags, goggles, handbook and nitrile gloves

Catalog #	Type	Size	Shipping Wt. (lbs)	Pallet Qty.	Qty.
SC-Cabinet	Spill control cabinet	19-7/8 in. x 14-1/4 in. x 32-3/4 in.	45	9	1/each
SC-Cabinet-UF	Universal fill	20 in. x 20 in. x 20 in.	21	12	1/each
SC-Cabinet-OF	Oil-only fill	20 in. x 20 in. x 20 in.	21	12	1/each
SC-Cabinet-HF	Chemical fill	20 in. x 20 in. x 20 in.	21	12	1/each



* Absorbents sold separately.

High-visibility spill station signs



LOSRO3A 8 in. x 8 in. Acrylic



V1SR03A 6 in. x 9 in. x 4 in. Acrylic



V2SS24A 8 in. x 15 in. x 6 in. Acrylic

Absorbents and Spill Control

BradyID.com/s36

Emergency response spill kits to handle any type of spill

Accidents happen, so it's better to be prepared. Brady SPC offers a complete selection of spill kits in a variety of types and sizes to equip you with everything you need to clean-up spills when they occur. Quickly and easily clean-up oils, solvents, coolants and other fluids. They are ideal for fast response to critical accidents.

Liquids absorbed

Universal For oil, water-based and chemical liquids

Oil Only For oil and petroleum-based liquids

Mixed (Universal and Oil Only) For indoor / outdoor use. Kits contain both all-purpose universal absorbents and water-repellent oil-only absorbents for petroleum and oil-based liquids

Chemical For aggressive and hazardous liquids

BRIGHTSORB® High-Visibility Safety Absorbents For all liquids. Bright safety messaging signals to those in and around the spill containment area to exercise caution

Re-Form Universal absorbents that are eco-friendly

TAA Compliant Complies with the Trade Agreements Act



Trade Agreement (TAA) Compliant Kits

GSA Schedule Contracts are subject to the Trade Agreements Act (TAA), meaning all products listed on the GSA Schedule Contract must be manufactured or “substantially transformed” in a “designated country.” The designated countries are comprised of:

- World Trade Organization government procurement agreement countries
- Free trade agreement countries
- Least developed countries and Caribbean basin countries

Where should Spill Kits be located?

Worker productivity and efficiencies can be improved dramatically by strategically placing spill kits or absorbent storage centers around the facility, closer to areas of need. For both emergency response and routine maintenance and safety, employees should not be wandering away from their workstation to the other side of the plant or tool room to find the absorbent materials they need.



Shipping docks



Freight vehicles



Plant floors



Maintenance areas

Small Spill Response Kits

These kits are portable and have a small foot print — perfect for placement throughout your facility. Include them in each work cell, maintenance area, laboratory and on storage carts to ensure you're prepared when a spill occurs.



Available with BRIGHTSORB®
High Visibility Absorbents

MAXX® Packs

- Mini-packs in resealable zipper bags
- Kit dimensions: 15.5 in. x 19.5 in. x 20.5 in.

Contents: 20 pads (15 in. x 19 in.)

Catalog #	Type	Absorbency Capacity (gal)	Shipping Wt. (lbs)	Pallet Qty.	Qty.
MXP-U20	Universal	30	14	24	5/case
MXP-O20	Oil only	35	15	24	5/case
MXP-C20	BRIGHTSORB Chemical	30	14	24	5/case



BASIC Spill Kits

- Small selection of pads, SOCs and PPE makes these kits a perfect option for work cells, vehicles and small spaces
- Kit contained in a resealable, clear plastic bag
- Kit dimensions: 4.5 in. x 15 in. x 18 in.

Contents:

- 10 pads (15 in. x 19 in.)
- 2 SOCs (3 in. x 4 ft.)
- 1 disposal bag
- 1 pair goggles
- 1 pair nitrile gloves
- 1 instruction sheet

Catalog #	Type	Absorbency Capacity (gal)	Shipping Wt. (lbs)	Pallet Qty.	Qty.
SKA-BSC	* Universal	3	7	40	1/case
SKO-BSC	* Oil only	3	7	40	1/case

* **WARNING:** Cancer and Reproductive Harm www.P65Warnings.ca.gov



Attack Pac Spill Kit

- Space-saving, single-use kit, packed in puncture- and UV-resistant foil bag (includes grommet for hanging)
- Absorbs up to 7 gallons per kit
- Kit dimensions: 20 in. x 16 in. x 4 in.

Contents:

- 15 pads (15 in. x 19 in.)
- 3 SOCs (3 in. x 4 ft.)
- 1 disposal bag
- 1 pair goggles
- 1 pair nitrile gloves
- 1 instruction sheet

Catalog #	Type	Absorbency Capacity (gal)	Shipping Wt. (lbs)	Pallet Qty.	Qty.
SKA-ATK	Universal	7	36.5	24	4/case
SKA-ATK-TAA	Universal	7	36.5	24	4/case
SKO-ATK	Oil only	7	23	24	4/case
SKH-ATK	Chemical	7	25	24	4/case
SKR-ATK	Re-Form	7	36.5	24	4/case

Absorbents and Spill Control

BradyID.com/s36



Small Spill Response Kits (cont.)



Available with BRIGHTSORB® High Visibility Absorbents

Economy Spill Kit

- Highly-visible, yellow PVC bag for small spills
- Absorbs up to 5 gallons per kit
- Kit dimensions: 20 in. x 16 in. x 4 in.

Contents:

- 10 pads (15 in. x 19 in.)
- 2 SOCs (3 in. x 4 ft.)
- 1 pair nitrile gloves
- 1 instruction sheet
- 1 disposal bag

Catalog #	Type	Absorbency Capacity (gal)	Shipping Wt. (lbs)	Pallet Qty.	Qty.
SKA-PP	Universal	5	24	20	5/case
SKA-PP-TAA	Universal TAA	5	24	20	5/case
SKO-PP	Oil Only	5	24	20	5/case
SKCH-PP	BRIGHTSORB High Visibility	5	24	20	5/case
SKH-PP	Chemical	5	24	20	5/case
SKR-PP	Re-Form	5	24	20	5/case

Absorbents



Emergency Response Kit

- Quickly assess the absorbents you have through the clear shoulder bag when you respond to the spill
- Absorbs up to 15 gallons per kit
- Kit dimensions: 25.5 in. x 17 in. x 21.5 in.

Contents:

- 32 pads (15 in. x 19 in.)
- 5 SOCs (3 in. x 4 ft.)
- 1 pillow (18 in. x 18 in.)
- 2 disposal bags
- 1 pair goggles
- 1 pair nitrile gloves
- 1 instruction sheet

Catalog #	Type	Absorbency Capacity (gal)	Shipping Wt. (lbs)	Pallet Qty.	Qty.
SKA-CFB	Universal	15	25	24	1/case
SKO-CFB	Oil Only	15	25	24	1/case
SKH-CFB	Chemical	15	25	24	1/case



Emergency Spill Sak

- Portable economy spill kit packed in a reusable sack
- Absorbs up to 10 gallons per kit
- Kit dimensions: 32 in. x 20 in. x 12 in.

Contents:

- 10 pads (15 in. x 19 in.)
- 2 SOCs (3 in. x 12 ft.)
- 1 pillow (18 in. x 18 in.)
- 1 pair nitrile gloves
- 1 instruction sheet

Catalog #	Type	Absorbency Capacity (gal)	Shipping Wt. (lbs)	Pallet Qty.	Qty.
SKA-SAK	Universal	10	10	40	1/each
SKO-SAK	Oil Only	10	10	40	1/each
SKH-SAK	Chemical	10	10	40	1/each

Small

Medium

Large

Small Spill Response Kits (cont.)



2-Gallon Spill Response Plus Kit

- Small sized absorbents are versatile, durable and low linting
- Ideal for hospitality, retail, restaurants or anywhere that requires a small pad
- Absorbs up to 4.5 gallons per kit
- Kit dimensions: 9.75 in. x 10.5 in.

Contents:

- 20 pads (7.5 in. x 10 in.)
- 1 disposable bag
- 1 pair of nitrile gloves
- 1 pair of goggles
- 1 instruction sheet

Catalog #	Type	Absorbency Capacity (gal)	Shipping Wt. (lbs)	Pallet Qty.	Qty.
SKA-SRP	Universal	4.5	2.5	48	1/each
SKO-SRP	Oil only	4.5	2.5	48	1/each
SKH-SRP	Chemical	4.5	2.5	48	1/each



Mobile Spill Kaddie

- Mobile, compact emergency kit for fast spill response anywhere in the plant
- Absorbs up to 22 gallons per kit
- Kit dimensions: 18 in. x 17 in. x 39 in.

Contents:

- 1 roll (15 in. x 73 ft.)
- 5 SOC's (3 in. x 4 ft.)
- 8 pillows (10 in. x 10 in.)
- 5 disposal bags
- 1 pair goggles
- 1 pair nitrile gloves
- Emergency Response Guidebook

Catalog #	Type	Absorbency Capacity (gal)	Shipping Wt. (lbs)	Pallet Qty.	Qty.
SKA-K2	Universal	22	42	10	1/each
SKO-K2	Oil only	22	42	10	1/each
SKH-K2	Chemical	22	42	10	1/each
SKA-K2R	Universal refill*	22	25	20	1/each
SKO-K2R	Oil-only refill*	22	25	20	1/each
SKH-K2R	Chemical refill*	22	25	20	1/each

*Refills do not include the container.

Refills make restocking quick and easy

A critical step after a spill is cleaned up is to restock your spill kit in preparation for future spills. Many of the spill kits from Brady SPC have refills available, making it easy for you to restock with the appropriate products and quantities.



Absorbents

Absorbents and Spill Control

BradyID.com/s36



Small Spill Response: Vehicle Spill Kits

Spills are common during transportation. Make sure your fleet is outfitted with the appropriate kit to quickly attend to any spill when en route.



Economy Vehicle Spill Kits

- Compact emergency kit for fast spill response
- Easily fits in your truck, cab or storage cubby
- Universal and oil-only products for mixed fluid applications
- Absorbs up to 7.75 gallons per kit

Contents:

- 10 oil-only pads (15 in. x 19 in.)
- 10 universal pads (15 in. x 19 in.)
- 2 SOCs (3 in. x 42 in.)
- 1 putty pat
- 2 disposable bags
- 1 pair of goggles
- 1 pair of nitrile gloves

Catalog #	Type	Absorbency Capacity (gal)	Shipping Wt. (lbs)	Pallet Qty.	Qty.
BSCSK-CB	* Vehicle spill kit	7.75	7	50	1/each

* **WARNING:** Cancer and Reproductive Harm www.P65Warnings.ca.gov



Standard Vehicle Spill Kits

- Mobile, compact emergency kit for fast spill response
- Easily fits in your truck, cab or storage cubby
- Universal and oil-only products for mixed fluid applications
- Absorbs up to 11.5 gallons per kit

Contents:

- 20 oil-only pads (15 in. x 19 in.)
- 10 universal pads (15 in. x 19 in.)
- 3 SOCs (3 in. x 42 in.)
- 1 putty pat
- 2 disposable bags
- 1 pair of nitrile gloves
- 1 pair of goggles

Catalog #	Type	Absorbency Capacity (gal)	Shipping Wt. (lbs)	Pallet Qty.	Qty.
SK-VEH	Vehicle Spill Kit	11.5	9	50	1/each



Poly-Edge™ Mountable Spill Kit

- Slotted footprint makes mounting easy
- Constructed of lightweight 100% polyethylene that will not rust or corrode
- Water-resistant gasket keeps stored items dry
- Absorbs: up to 20 gallons per kit
Kit dimensions: 35 in. x 16 in. x 16 in.

Contents:

- 25 pads (15 in. x 19 in.)
- 4 SOCs (3 in. x 12 ft.)
- 1 drain cover
- 1 putty pat
- 2 disposable bags
- 1 hazmat suit
- 1 pair of goggles
- 1 pair of nitrile gloves
- 1 instruction sheet

Catalog #	Type	Absorbency Capacity (gal)	Shipping Wt. (lbs)	Pallet Qty.	Qty.
SKA-TRK	Universal	20	40	12	1/each
SKO-TRK	Oil Only	20	40	12	1/each

Absorbents

Small Spill Response: 6.5-Gallon Spill Kits

One of our most popular sized kits, these 6.5-gallon spill kits are the perfect size to combat common, smaller spills within your facility. The durable bucket protects your spill kit contents and allows for easy storage.



Available with **BRIGHTSORB®**
High Visibility Absorbents

6.5-Gallon Spill Bucket

- Easily accessible spill kit in a reusable bucket for a fast response to small spills
- Absorbs up to 5 gallons per kit
Kit dimensions: 14 in. x 18 in.

Contents:

- 10 pads (15 in. x 19 in.)
- 3 SOCs (3 in. x 4 ft.)
- 2 disposal bags
- 1 pair nitrile gloves
- 1 instruction sheet

Catalog #	Type	Absorbency Capacity (gal)	Shipping Wt. (lbs)	Pallet Qty.	Qty.
SKA-BKT	Universal	5	9	36	1/each
SKA-BKT-TAA	Universal TAA	5	9	36	1/each
SKO-BKT	Oil only	5	9	36	1/each
SKCH-BKT	BRIGHTSORB chemical	5	8	36	1/each
SKH-BKT	Chemical	5	8	36	1/each



Bodily Fluid Spill Kit

- Assortment of pads, neutralizer, SOCs and the appropriate PPE will make cleaning up bodily fluids safer and more efficient
- Reusable screw-top bucket keeps contents clean and easily accessible
- Absorbs up to 4.5 gallons per kit
Kit dimensions: 14 in. x 18 in.

Contents:

- Granular (1 lb.)
- 10 barrier-backed pads (15 in. x 19 in.)
- 2 disposal bags
- 1 case sanitary wipes
- 1 pair goggles
- 1 pair neoprene gloves
- 1 apron
- 1 small scoop and scraper

Catalog #	Type	Absorbency Capacity (gal)	Shipping Wt. (lbs)	Pallet Qty.	Qty.
SK-BF	Bodily fluid spill kit	4.5	9	36	1/each

Absorbents and Spill Control

BradyID.com/s36



Small Spill Response: Specialty Kits

These specialty 6.5-gallon spill kits are the perfect size to combat common, smaller spills within your facility. The durable bucket protects your spill kit contents and allows for easy storage.



6.5-Gallon Acid / Base Neutralizer Spill Kit

- Used to solidify a wide range of spills
- Polymers will neutralize and change color to let you know neutralization has taken place. Acid neutralizer changes to purple, base neutralizer changes to orange.
- Absorbs up to 4.5 gallons per kit
Kit dimensions: 14 in. x 18 in.

Contents:

- 1.5 gallon bucket
- 2 SOC's (3 in. x 4 ft.)
- 1 pair nitrile gloves
- 1 neutralizer shaker (2 lb.)
- 2 disposal bags
- 1 Tyvek Suit
- 10 pads (15 in. x 19 in.)
- 1 pair goggles
- 1 small scoop

Catalog #	Type	Absorbency Cap. (gal)	Shipping Wt. (lbs)	Pallet Qty.	Qty.
SKA-BKTACID	Acid Neutralizing Kit	4.5	16.5	36	1/each
SKA-BKTBASE	Base Neutralizer Kit	4.5	16.5	36	1/each
SPC-ACID	Acid Neutralizing Polymer Shaker Only (2lb)	0.65	2	1,200	1/each*
SPC-BASE	Base Neutralizing Polymer Shaker Only (2lb)	0.65	2	1,200	1/each*

*Minimum order of 12 individual shakers.

Absorbents



Battery Acid Spill Kit

- Granular, neutralizer and the appropriate absorbents will help simplify the battery acid spill clean up process
- Reusable screw-top bucket keeps contents clean and easily accessible
- Absorbs up to 4.5 gallons per kit
Kit dimensions: 14 in. x 18 in.

Contents:

- Granular (1 lb.)
- 2 SOC's (3 in. x 4 ft.)
- 1 apron
- 1 neutralizer shaker (2 lb.)
- 2 disposal bags
- 1 faceshield
- 1 pair goggles
- 1 pair neoprene gloves
- 1 small scoop and scraper
- 10 pads (15 in. x 19 in.)

Catalog #	Type	Absorbency Cap. (gal)	Shipping Wt. (lbs)	Pallet Qty.	Qty.
SK-BATT	Battery Acid Spill Kit	4.5	9	36	1/each

Small Spill Response: Specialty Kits (cont.)



Mercury Spill Kit

- Mercury powder is specifically designed to neutralize mercury spills. Then wipe clean with absorbent pads and scoop up any particles that remain.
- Reusable screw-top bucket keeps contents clean and easily accessible
- Absorbs up to 4.5 gallons per kit
Kit dimensions: 14 in. x 18 in.

Contents:

- Mercury absorbent powder (2 lb.)
- 10 pads (15 in. x 19 in.)
- 2 disposal bags
- 1 pair goggles
- 1 pair neoprene gloves
- 1 small scoop and scraper

Catalog #	Type	Absorbency Cap. (gal)	Shipping Wt. (lbs)	Pallet Qty.	Qty.
SK-MERC	Mercury spill kit	4.5	9	36	1/each



Formaldehyde Spill Kit

- Reusable screw-top bucket keeps contents clean and easily accessible
- Absorbs up to 4.5 gallons per kit
Kit dimensions: 14 in. x 18 in.

Contents:

- Granular (1 lb.)
- 1 acid neutralizer shaker (2 lb.)
- 10 pads (15 in. x 19 in.)
- 2 disposal bags
- 1 pair goggles
- 1 pair neoprene gloves
- 1 respirator
- 1 small scoop and scraper

Catalog #	Type	Absorbency Cap. (gal)	Shipping Wt. (lbs)	Pallet Qty.	Qty.
SK-FORM	Formaldehyde spill kit	4.5	9	36	1/each

Spill Kit Tamper Proof Label

When a spill occurs, you need your spill kit to be fully intact. Use Brady SPC tamper proof labels to indicate if a spill kit has been opened and may need replacing.

Catalog #	Type	Size	Qty.
TAMPER	Tamper proof label	3.5" x 5"	5/pack



Absorbents and Spill Control

BradyID.com/s36



Medium Spill Response: 20-Gallon Spill Kits

Easily deployable 20-gallon spill kits are perfect for medium-sized spills throughout your facility — particularly in areas with fluid transfer.



Available with BRIGHTSORB® High Visibility Absorbents

20-Gallon Lab Pack

- UN-approved water and chemical resistant polyethylene container with screw-top lid for medium response
- Absorbs up to 17 gallons per kit
Kit dimensions: 21 in. x 18 in.

Contents:

- 12 pads (15 in. x 19 in.)
- 3 SOCs (3 in. x 12 ft.)
- 2 pillows (18 in. x 18 in.)
- 3 disposal bags
- 1 pair goggles
- 1 pair nitrile gloves
- Emergency Response Guidebook

Catalog #	Type	Absorbency Capacity (gal)	Shipping Wt. (lbs)	Pallet Qty.	Qty.
SKA-20	Universal	17	26	12	1/each
SKA-20-TAA	Universal	17	26	12	1/each
SKO-20	Oil Only	17	26	12	1/each
SKCH-20	BRIGHTSORB High Visibility	17	26	12	1/each
SKH-20	Chemical	17	26	12	1/each
SKA20-R	Universal Refill*	17	13	16	1/each
SKO20-R	Oil-only refill*	17	13	16	1/each
SKH20-R	Chemical Refill*	17	13	16	1/each

*Refills do not include the container.

20-Gallon Mixed Application Spill Kit

- For response to both water- and petroleum-based spills
- Absorbs up to 17 gallons per kit
Kit dimensions: 21 in. x 18 in.

Contents:

- 6 universal pads (15 in. x 19 in.)
- 6 oil-only pads (15 in. x 19 in.)
- 1 universal pillow (18 in. x 18 in.)
- 1 oil-only pillow (18 in. x 18 in.)
- 3 disposal bags
- 1 pair goggles
- 1 pair nitrile gloves
- Emergency Response Guidebook

Catalog #	Type	Absorbency Capacity (gal)	Shipping Wt. (lbs)	Pallet Qty.	Qty.
SKMA-20	Mixed	17	20	12	1/each

20-Gallon Rescue Spill Kit

- Included caution tape and a wet floor sign help prevent slips, trips and falls while a spill is being cleaned up
- Absorbs up to 17 gallons per kit
Kit dimensions: 21 in. x 18 in.

Contents:

- 12 pads (15 in. x 19 in.)
- 3 SOCs (3 in. x 12 ft.)
- 2 pillows (18 in. x 18 in.)
- 3 disposal bags
- 1 pair goggles
- 1 pair nitrile gloves
- 1 roll caution tape (3 in. x 200 ft.)
- 1 wet floor sign (18 in.)
- Emergency Response Guidebook

Catalog #	Type	Absorbency Capacity (gal)	Shipping Wt. (lbs)	Pallet Qty.	Qty.
SKA-20-RESCUE	Universal	17	20	12	1/each
SKO-20-RESCUE	Oil Only	17	20	12	1/each
SKH-20-RESCUE	Chemical	17	20	12	1/each



Absorbents

Medium Spill Response: 30-Gallon Spill Kits

Looking for something a little larger? Look no further than the 30-gallon kit. Absorbing up to 36 gallons, these kits are perfect for medium-sized spills. Store throughout your facility — particularly in areas where fluid transfer is prevalent.



30-Gallon Spill Kit

- UN-approved water- and chemical-resistant polyethylene container with screw-top lid
- Kit refills are available for easy re-stocking after a spill
- Absorbs up to 29 gallons per kit
Kit dimensions: 21.125 in. x 28.5 in.

Contents:

- 25 pads (15 in. x 19 in.)
- 6 SOC's (3 in. x 12 ft.)
- 6 pillows (9 in. x 9 in.)
- 3 disposal bags
- 1 pair goggles
- 1 pair of nitrile gloves
- Emergency Response Guidebook

Catalog #	Type	Absorbency Capacity (gal)	Shipping Wt. (lbs)	Pallet Qty.	Qty.
SKA30	Universal	29	41	12	1/each
SKA30TAA	Universal TAA	29	41	12	1/each
SKO30	Oil only	29	41	12	1/each
SKH30	Chemical	29	41	12	1/each
SKA30-R	Universal refill*	29	28	12	1/each
SKO30-R	Oil-only refill*	29	26	12	1/each
SKH30-R	Chemical refill*	29	28	12	1/each

*Refills do not include the container.

Absorbents



30-Gallon Mixed Application Spill Kit

- A single spill kit to respond to both water- and petroleum-based spills
- Absorbs up to 29 gallons per kit
Kit dimensions: 21.125 in. x 28.5 in.

Contents:

- 15 universal pads (15 in. x 19 in.)
- 15 oil-only pads (15 in. x 19 in.)
- 3 universal SOC's (3 in. x 12 ft.)
- 3 oil-only SOC's (3 in. x 12 ft.)
- 3 universal pillows (18 in. x 18 in.)
- 3 oil-only pillows (18 in. x 18 in.)
- 3 disposal bags
- 1 pair goggles
- 1 pair nitrile gloves
- Emergency Response Guidebook

Catalog #	Type	Absorbency Capacity (gal)	Shipping Wt. (lbs)	Pallet Qty.	Qty.
SKMA-30	Mixed	29	41	12	1/each

Absorbents and Spill Control

BradyID.com/s36



Large Spill Response: 55-Gallon Spill Kits

55-gallon spill kits are essential in any facility. Keep them near entrances and exits for emergency deployment to prevent facility spills from entering the environment.



Available with BRIGHTSORB® High Visibility Absorbents

55-Gallon Drum Spill Kit

- Lever-locked 55-gallon drum meets UN specifications and is ideal for medium spills
- Kit refills are available for easy re-stocking after a spill
- Absorbs up to 38 gallons per kit
- Kit dimensions: 24 in. x 37 in.
Wheeled kit dimensions: 23 in. dia. x 37 in.

Contents:

- 50 pads (15 in. x 19 in.)
- 4 SOCs (3 in. x 12 ft.)
- 8 pillows (18 in. x 18 in.)
- 5 disposal bags
- 1 pair goggles
- 1 pair nitrile gloves
- Emergency Response Guidebook

Catalog #	Type	Absorbency Capacity (gal)	Shipping Wt. (lbs)	Pallet Qty.	Qty.
SKA55	Universal	38	57	8	1/each
SKA55-TAA	Universal TAA	38	56	8	1/each
SKO55	Oil only	38	56	8	1/each
SKCH-55	Brightisorb chemical	38	52	8	1/each
SKH55	Chemical	38	52	8	1/each
SKA55W	Universal w/ wheels	38	57	8	1/each
SKO55W	Oil only w/ wheels	38	56	8	1/each
SKH55W	Chemical w/ wheels	38	52	8	1/each
SKA55-R	Universal refill*	38	37	8	1/each
SKO55-R	Oil-only refill*	38	37	8	1/each
SKH55-R	Chemical refill*	38	37	8	1/each

*Refills do not include the container.

Absorbents



55-Gallon Mixed Application Spill Kit

- A single spill kit to respond to spills of water-based and petroleum-based spills
- Absorbs up to 46 gallons per kit
- Kit dimensions: 24 in. x 37 in.
Wheeled kit dimensions: 23 in. dia. x 37 in.

Contents:

- 25 universal pads (15 in. x 19 in.)
- 25 oil-only pads (15 in. x 19 in.)
- 2 universal SOCs (3 in. x 12 ft.)
- 2 oil-only SOCs (3 in. x 12 ft.)
- 4 universal pillows (18 in. x 18 in.)
- 4 oil-only pillows (18 in. x 18 in.)
- 5 disposal bags
- 1 pair goggles
- 1 pair nitrile gloves
- Emergency Response Guidebook

Catalog #	Type	Absorbency Capacity (gal)	Shipping Wt. (lbs)	Pallet Qty.	Qty.
SKMA-55	Mixed	46	52	8	1/each
SKMA-55W	Mixed w/ Wheels	46	52	8	1/each

Large Spill Response: 65-Gallon Spill Kits

If you require a larger spill kit but don't have a lot of space, the 65-gallon kit is the perfect solution. These kits have almost double the absorbents of a 55-gallon kit without doubling in size.



65-Gallon Spill Kit

- UN-approved water- and chemical-resistant polyethylene overpack drum with screw-top lid is reusable and meets DOT specifications
- Kit refills are available for easy re-stocking after a spill
- Absorbs up to 63 gallons per kit
- Kit dimensions: 31 in. x 33.5 in.
Wheeled kit dimensions: 31 in. x 42 in.

Contents:

- 100 pads (15 in. x 19 in.)
- 7 SOCs (3 in. x 12 ft.)
- 7 pillows (18 in. x 18 in.)
- 5 disposal bags
- 1 pair goggles
- 1 pair of nitrile gloves
- Emergency Response Guidebook

Catalog #	Type	Absorbency Capacity (gal)	Shipping Wt. (lbs)	Pallet Qty.	Qty.
SKA65	Universal	63	100	3	1/each
SKA65TAA	Universal TAA	63	100	3	1/each
SKO65	Oil only	63	100	3	1/each
SKH65	Chemical	63	100	3	1/each
SKA65W	Universal w/ wheels	63	100	3	1/each
SKO65W	Oil only w/ wheels	63	100	3	1/each
SKH65W	Chemical w/ wheels	63	100	3	1/each
SKA65-R	Universal refill*	63	40	3	1/each
SKO65-R	Oil-only refill*	63	40	3	1/each
SKH65-R	Chemical refill*	63	40	3	1/each

*Refills do not include the container.



65-Gallon Mixed Application Spill Kit

- A single spill kit to respond to both water-based and petroleum-based spills
- Absorbs up to 65 gallons per kit
- Kit dimensions: 31 in. x 33.5 in.
Wheeled kit dimensions: 31 in. x 42 in.

Contents:

- 50 universal pads (15 in. x 19 in.)
- 50 oil-only pads (15 in. x 19 in.)
- 4 universal SOCs (3 in. x 12 ft.)
- 3 oil-only SOCs (3 in. x 12 ft.)
- 4 universal pillows (18 in. x 18 in.)
- 5 disposal bags
- 1 pair goggles
- 1 pair nitrile gloves
- Emergency Response Guidebook

Catalog #	Type	Absorbency Capacity (gal)	Shipping Wt. (lbs)	Pallet Qty.	Qty.
SKMA-65	Mixed	65	100	3	1/each
SKMA-65W	Mixed w/ Wheels	65	100	3	1/each

Absorbents and Spill Control

BradyID.com/s36



Large Spill Response: 95-Gallon Spill Kits

95-gallon kits will keep you prepared for almost any spill. Keep these on hand in areas where the likelihood of larger spills is greatest.



Available with BRIGHTSORB® High Visibility Absorbents

95-Gallon Overpack

- UN-approved water- and chemical-resistant polyethylene overpack drum with screw-top lid is reusable and meets DOT specifications
- Refill kits are available for easy re-stocking after a spill
- Absorbs up to 75 gallons per kit
- Kit dimensions: 31.5 in. x 35 in.
Wheeled kit dimensions: 31.5 in. x 47 in.

Contents:

- 110 pads (15 in. x 19 in.)
- 12 SOCs (3 in. x 4 ft.)
- 8 SOCs (3 in. x 12 ft.)
- 8 pillows (18 in. x 18 in.)
- 10 disposal bags
- 1 pair goggles
- 1 pair nitrile gloves
- Emergency Response Guidebook

Catalog #	Type	Absorbency Capacity (gal)	Shipping Wt. (lbs)	Pallet Qty.	Qty.
SKA-95	Universal	75	107	2	1/each
SKO-95	Oil Only	75	107	2	1/each
SKCH-95	BRIGHTSORB chemical	75	104	2	1/each
SKH-95	Chemical	75	104	2	1/each
SKA-95W	Universal w/ wheels	75	107	2	1/each
SKO-95W	Oil only w/ wheels	75	107	2	1/each
SKH-95W	Chemical w/ wheels	75	104	2	1/each
SKA95-R	Universal refill*	75	60	3	1/each
SKO95-R	Oil-only refill*	75	60	3	1/each
SKH95-R	Chemical refill*	75	60	3	1/each

*Refills do not include the container.

Absorbents



95-Gallon Mixed Application Spill Kit

- A single spill kit to respond to both water-based and petroleum-based spills
- Absorbs up to 77 gallons per kit
- Kit dimensions: 31.5 in. x 35 in.
Wheeled kit dimensions: 31.5 in. x 47 in.

Contents:

- 55 universal pads (15 in. x 19 in.)
- 55 oil-only pads (15 in. x 19 in.)
- 6 universal SOCs (3 in. x 4 ft.)
- 6 oil-only SOCs (3 in. x 4 ft.)
- 4 universal SOCs (3 in. x 12 ft.)
- 4 oil-only SOCs (3 in. x 12 ft.)
- 4 universal pillows (18 in. x 18 in.)
- 4 oil-only pillows (18 in. x 18 in.)
- 10 disposal bags
- 1 pair goggles
- 1 pair nitrile gloves
- Emergency Response Guidebook

Catalog #	Type	Absorbency Capacity (gal)	Shipping Wt. (lbs)	Pallet Qty.	Qty.
SKMA-95	Mixed	77	107	2	1/each
SKMA-95W	Mixed w/ Wheels	77	107	2	1/each

X-Large Spill Response: Mobile Spill Trucks

In the event of a substantial spill, keep your facility prepared. Mobile spill trucks are filled with all of the essentials you'll need for major spill clean-up.



Mobile Spill Truck - Large

- Wheel-mounted polyethylene bins are chemical and water resistant. Spill trucks provide the highest level of readiness
- Absorbs up to 169 gallons per kit.
- Kit dimensions: 47 in. x 34 in. x 43 in.

Contents of

Universal and Oil-Only Kits:

- 200 pads (15 in. x 19 in.)
- 24 SOC's (3 in. x 4 ft.)
- 12 SOC's (3 in. x 12 ft.)
- 8 pillows (17 in. x 19 in.)
- 15 disposal bags
- 1 pair goggles
- 3 pair nitrile gloves
- Emergency Response Guidebook

Contents of

Marine Kit:

- 400 pads (15 in. x 19 in.)
- 4 booms (5 in. x 10 ft.)
- 1 sweep (19 in. x 100 ft.)
- 15 disposal bags
- 6 pairs of nitrile gloves
- 1 pair goggles
- Emergency Response Guidebook

Catalog #	Type	Absorbency Capacity (gal)	Shipping Wt. (lbs)	Pallet Qty.	Qty.
SKA-LT	Universal	134	164	1	1/each
SKO-LT	Oil only	126	185	1	1/each
SKM-LT	Marine	169	164	1	1/each



Mobile Spill Truck - X-Large

- Mobile spill response kit in a water- and chemical-resistant large bin
- Absorbs up to 282 gallons per kit
- Kit dimensions: 57.5 in. x 40.5 in. x 47 in.

Contents of

Universal and Oil-Only Kits:

- 250 pads (15 in. x 19 in.)
- 36 SOC's (3 in. x 4 ft.)
- 20 SOC's (3 in. x 12 ft.)
- 8 pillows (18 in. x 18 in.)
- 30 disposal bags
- 3 pairs of nitrile gloves
- 1 pair goggles
- Emergency Response Guidebook

Contents of

Marine Kit:

- 600 pads (15 in. x 19 in.)
- 8 booms (5 in. x 10 ft.)
- 1 sweeps (19 in. x 100 ft.)
- 15 disposal bags
- 6 pairs of nitrile gloves
- 1 pair goggles
- Emergency Response Guidebook

Catalog #	Type	Absorbency Capacity (gal)	Shipping Wt. (lbs)	Pallet Qty.	Qty.
SKA-XLT	Universal	184	221	1	1/each
SKO-XLT	Oil only	174	221	1	1/each
SKM-XLT	Marine	282	258	1	1/each

Facility Marking Tape

BradyID.com/s36

Create a visual workplace with facility and floor marking products

Visual Workplace is a lean concept that emphasizes putting critical information at the point of use. Companies that incorporate lean visuals throughout their facility are proven to have higher productivity, reduced waste, and improved safety.

Visuals can be something as simple as a line, shape or color band — whatever employees can understand at a glance. Or visuals can include signs, labels, displays and more.



OSHA regulations now include aisle marking

OSHA has recently begun requiring, or implying, the need for marking and color coding.

OSHA - Use of Mechanical Equipment

1910.176(a) Where mechanical handling equipment is used, sufficient safe clearances shall be allowed for aisles, at loading docks, through doorways and wherever turns or passage must be made. Permanent aisles and passageways shall be appropriately marked.

OSHA - Letter of Interpretation

1910.22(b) The lines used to delineate aisles may be any color so long as they clearly define the area considered as aisle space. The lines may be composed of dots, square, strip or continuous. The recommended width of aisle markings varies from 2 in. to 6 in., therefore any width 2 in. or more is considered acceptable.

OSHA - Means of Egress

1910.35 OSHA will deem an employer demonstrating compliance with the exit route provisions of NFPA 101, Life Safety Code, or the exit route provisions of the IFC 2009, to be in compliance with 190.34, 1910.36 and 1910.37.

IFC - International Fire Code 2009

1024.1 Approved luminous egress path markings delineating the exit path shall be provided...having occupied floors located more than 75 ft. above the lowest level of fire department vehicle access.

1024.2.1 A solid and continuous stripe shall be applied to the horizontal leading edge of each step and shall extend the full length of each step.

1024.2.4 Perimeter and floor mounted demarcation lines shall be placed within 4 in. of the wall and extend to within 2 in. of the markings on the leading edge of landings. Demarcation lines shall be 1 in. to 2 in. wide with interruptions not exceeding 4 in.

ToughStripe Max Floor Marking Tape (B-543)

- Resistance to cuts and scrapes in high-traffic forklift and industrial-vehicle traffic areas due to its increased thickness (1.25 mm)
- Aggressive adhesive performance to floor, but easily removes in one piece
- Tapered edges minimize "pick points" and traffic bumps
- Service temperature range of 0° F to 140° F (-18° C to 60° C)

	2 in. x 100 ft.	3 in. x 100 ft.	4 in. x 100 ft.
Yellow	149629	149636	149643
Yw / Blk Striped	149630	149637	149644
Red	149634	149641	149648
Orange	149635	149642	-
White	149633	149640	149647
Green	149632	149639	149646
Blue	149631	149638	149645



Toughstripe Floor Marking Tape (B-514)

- Ideal for marking aisles, passageways and storage locations, and pointing out important safety equipment and egress paths
- Exceeds OSHA and ANSI safety standards for clean, dry non-slip surfaces
- 0.2 mm thickness and service temperature 0° F to 140° F (-18° C to 60° C)
- Custom colors available



Colors

	2 in. x 100 ft.	3 in. x 100 ft.	4 in. x 100 ft.
Yellow	104312	104342	104372
Red	104313	104343	104373
Orange	104316	104346	104376
White	104311	104341	104371
Green	104315	104345	104375
Blue	104314	104344	104374
Purple	134086	134087	134088
Brown	134089	134090	134091
Grey	134092	134093	134094
Black	104310	104340	104370



Stripes

	2 in. x 100 ft.	3 in. x 100 ft.	4 in. x 100 ft.
Yw / Blk	104317	104347	104377
Rd / Wht	104318	104348	104378
Rd / Yw	132430	132431	132432
Org / Blk	132433	132434	132435
Wht / Blk	104319	104349	104379
Gm / Wht	132436	132437	132438
Blu / Yw	132439	132440	132441



Checkers

	2 in. x 100 ft.	3 in. x 100 ft.	4 in. x 100 ft.
Rd / Wht	121916	121917	121918
Blk / Wht	121913	121914	121915



Overlaminate Tape

Catalog #	Description	Size
142134	Overlaminate	1 in. x 50 ft.
142136	Overlaminate	1.125 in. x 100 ft.
142135	Overlaminate	2 in. x 50 ft.
142137	Overlaminate	2.250 in. x 100 ft.
142138	Overlaminate	3 in. x 100 ft.
142139	Overlaminate	4 in. x 100 ft.

ToughStripe Floor Tape Applicator

- One applicator for all of your floor marking tapes — including thick, heavy-duty tapes and thin, temporary tapes
- Adjusts to fit 2 in. to 4 in. tape widths
- Lightweight, ergonomic design makes tape application easy
- Applicator winds tape liner onto an extra core as you go to make clean up fast and easy
- Small footprint fits in tight spaces

Catalog #	Description	Qty
150852	ToughStripe Floor Tape Applicator	1



Adjusts to fit 2 in. to 4 in. tape widths

ToughStripe® Floor Marking

BradyID.com/s36

ToughStripe Floor Marking Die-cut Shapes

- All the durability and high visibility of ToughStripe Floor Marking Tape, but in die-cut shapes



Dots

	3.5 in. Dia. 350/roll
Yellow	104403
Red	104400
White	104405
Green	104401
Blue	104402
Black	104404



Arrows

	2 in. x 5 in. 100/pack	3 in. x 8 in. 100/pack	4 in. x 10 in. 100/pack
Yellow	104415	104421	104427
Red	104412	104418	104424
White	104417	104423	104429
Green	104413	104419	104425
Blue	104414	104420	104426
Black	104416	104422	104428



Footprints

	10 ft. x 3.5 in. 5 right and 5 left/pack
Yellow	104409
Red	104406
White	104411
Green	104407
Blue	104408
Black	104410



Corner Marks

	2 in. x 5 in. 20/pack	3 in. x 8 in. 20/pack	4 in. x 10 in. 20/pack
Yellow	104433	104445	104457
Red	104430	104442	104454
White	104435	104447	104459
Green	104431	104443	104455
Blue	104432	104444	104456
Black	104434	104446	104458



Center Marks

	2 in. x 5 in. 20/pack	3 in. x 8 in. 20/pack	4 in. x 10 in. 20/pack
Yellow	104469	104475	104481
Red	104466	104472	104478
White	104471	104477	104483
Green	104467	104473	104479
Blue	104468	104474	104480
Black	104470	104476	104482



Divider Marks

	2 in. x 5 in. 20/pack	3 in. x 8 in. 20/pack	4 in. x 10 in. 20/pack
Yellow	104439	104451	104463
Red	104436	104448	104460
White	104441	104453	104465
Green	104437	104449	104461
Blue	104438	104450	104462
Black	104440	104452	104464

Pre-Spaced ToughStripe Shapes

Quickly lay straight, evenly spaced shapes. Simply lay down the continuous tape, then remove the clear transfer tape. No need to apply markings one by one.

	3.5 in. x 100 ft. 55 dots/18 in. apart	2 in. x 5 in. x 100 ft. 52 arrows/18 in. apart	2 in. x 8 in. x 100 ft. 46 dashes/18 in. apart
Yellow	104523	104529	104556
Red	104521	104526	142179
White	104522	104555	142177
Green	104520	104527	142181
Blue	104524	104528	142180
Black	104525	104554	142178



Pre-Printed ToughStripe Tape

Stock or custom legends available (18 character limit)

Legend	Color	2 in. x 100 ft.	3 in. x 100 ft.	4 in. x 100 ft.
QA Inspection Area	Blk on Org	121364	121365	121366
Caution ESD Area	Blk on Ylw	121367	121368	121369



Facility Marking Tape



Print-On-Demand ToughStripe Tape (B-483)

ToughStripe is available as a printable material for several of Brady's printers, allowing you to create custom floor labels for your facility. Simply print desired label from a select Brady printer, position label on floor and apply included B-634 polyester overlamine for print protection.

Benchtop printers
See page 49

BMP®71 Portable Printer
See page 152

Toughstripe Floor Marking Signs

Toughstripe B-534 polyester floor signs resist harsh chemicals and are specifically designed to alert workers of potential dangers and enforce protective equipment requirements.

- Exceeds safety standards for clean, dry non-slip surfaces per ANSI A1264.2-2006 and OSHA 1910.22
- Black areas of signs are coated with anti-slip tread
- 3-mil thickness, service temperature 0° F to 130° F (18° C to 54° C)
- US Patent No 8,302,337

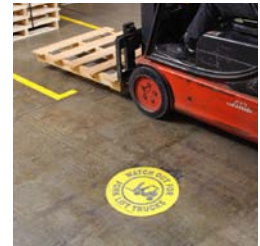

Arrow Symbol
104489 - 17 in. dia.



Emergency Exit
104495 - 17 in. dia.



Emergency Stairs
104496 - 17 in. dia.



Exit Arrow
104490 - 17 in. dia.



Fire Extinguisher
104492 - 17 in. dia.



Fire Alarm
104493 - 17 in. dia.



Fire Hose
104494 - 17 in. dia.



Pedestrian Traffic Only
104509 - 17 in. dia.



Watch Out For Fork Lift
104501 - 17 in. dia.



Warning Forklift Traffic
104512 - 17 in. dia.



Production Area
104513 - 17 in. dia.



First Aid w/Arrow
104486 - 17 in. dia.



Safety Shower
104487 - 17 in. dia.



Eye Wash
104507 - 17 in. dia.



Stop
104511 - 17 in. dia.



Keep Aisles Clear
104508 - 17 in. dia.



Radiation Area
104488 - 14 in. x 18 in.



First Aid
104491 - 14 in. x 18 in.



Do Not Enter
104497 - 14 in. x 18 in.



Chemical Storage
104498 - 14 in. x 18 in.

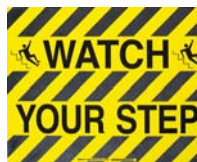

Watch Your Step
104499 - 14 in. x 18 in.



No Smoking
104500 - 14 in. x 18 in.



Ear Protection Area
104502 - 14 in. x 18 in.



Eye Protection Area
104503 - 14 in. x 18 in.

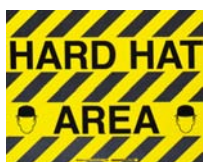

Hard Hat Area
104504 - 14 in. x 18 in.

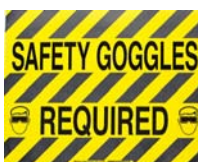

Safety Goggles Required
104505 - 14 in. x 18 in.



Biohazard
104506 - 14 in. x 18 in.



Safety Glasses Required
104510 - 14 in. x 18 in.

ToughStripe® Floor Marking

BradyID.com/s36

ToughStripe Numbers and Letters

- Easy-to-see 6 in. x 8 in. numbers and letters are ideal for marking aisles, shipping and receiving docks, distribution centers and other areas of your facility
- Material removes cleanly without any unsightly adhesive residue or damage to the floor
- Exceeds safety standards for clean, dry non-slip surfaces per ANSI A 1264.2-2006 and OSHA 1910.22



Legend	Black 20/sheets	White 20/sheets	Red 20/sheets	Green 20/sheets	Blue 20/sheets	Yellow 20/sheets
A	121691	121692	121693	121694	121695	121696
B	121697	121698	121699	121700	121701	121702
C	121703	121704	121705	121706	121707	121708
D	121709	121710	121711	121712	121713	121714
E	121715	121716	121717	121718	121719	121720
F	121721	121722	121723	121724	121725	121726
G	121727	121728	121729	121730	121731	121732
H	121733	121734	121735	121736	121737	121738
I	121739	121740	121741	121742	121743	121744
J	121745	121746	121747	121748	121749	121750
K	121751	121752	121753	121754	121755	121756
L	121757	121758	121759	121760	121761	121762
M	121763	121764	121765	121766	121767	121768
N	121769	121770	121771	121772	121773	121774
O	121775	121776	121777	121778	121779	121780
P	121781	121782	121783	121784	121785	121786
Q	121787	121788	121789	121790	121791	121792
R	121793	121794	121795	121796	121797	121798
S	121799	121800	121801	121802	121803	121804
T	121805	121806	121807	121808	121809	121810

Legend	Black 20/sheets	White 20/sheets	Red 20/sheets	Green 20/sheets	Blue 20/sheets	Yellow 20/sheets
U	121811	121812	121813	121814	121815	121816
V	121817	121818	121819	121820	121821	121822
W	121823	121824	121825	121826	121827	121828
X	121829	121830	121831	121832	121833	121834
Y	121835	121836	121837	121838	121839	121840
Z	121841	121842	121843	121844	121845	121846
0	121847	121848	121849	121850	121851	121852
1	121853	121854	121855	121856	121857	121858
2	121859	121860	121861	121862	121863	121864
3	121865	121866	121867	121868	121869	121870
4	121871	121872	121873	121874	121875	121876
5	121877	121878	121879	121880	121881	121882
6	121883	121884	121885	121886	121887	121888
7	121889	121890	121891	121892	121893	121894
8	121895	121896	121897	121898	121899	121900
9	121901	121902	121903	121904	121905	121906
Punctuation Set*	121907	121908	121909	121910	121911	121912

* Each set includes: 40 periods, 20 commas, 20 question marks, 20 exclamation points, 20 forward slashes, 20 dashes and 20 ampersands.

Premium 5S Marking Kits with ToughStripe Floor Marking Tape

Everything you need to 5S your facility, enhancing workplace organization and efficiency.

Premium 5S Marking Kit Includes:

- ToughStripe Floor Marking Tape
 - 4 rolls of 2 in. ToughStripe floor tape (1 yellow, 1 red, 1 blue, 1 green)
 - 4 packs of 2 in. L-shaped corner marks (1 yellow, 1 red, 1 blue, 1 green)
- Toolboard / Workbench Marking Tapes
 - 4 rolls of 12 in. shadow vinyl (1 black, 1 red, 1 blue, 1 green)
 - 4 rolls of 0.5 in. border tape (1 black, 1 red, 1 blue, 1 green)
 - 4 rolls of 0.5 in. L-shaped corner marks (1 black, 1 red, 1 blue, 1 green)

Catalog #	Description
142109	Premium 5S Kit

Premium 5S Kit with BMP®71 Label Printer Includes:

- All contents of Premium 5S Marking Kit above, plus:
- BMP71 Printer with hard carrying case and charger / AC power adaptor
- 3 white vinyl tape cartridges (0.5 in., 1 in., 2 in.)
- 1 yellow vinyl tape cartridge (2 in.)
- 2 ribbon cartridges (1 black, 1 red)

Catalog #	Description
142111	Premium 5S Kit with BMP71 Label Printer



Learn more about the BMP®71 Label Printer on page 152

PaintStripe™ Floor Marking Stencil

- Faster application, exact measurement and precise control
- Two adhesive types to securely mask edges and provide easy removal on concrete and other floor surfaces
- Printed cut-lines and a repeating 12-inch ruler facilitate accurate length measurement and rapid alignment of 90° corners
- Ideal for areas where paint is preferred for line-marking, such as areas with aggressive or abrasive traffic conditions, or facilities that are unable to use aisle marking tapes due to wet floors, washdown conditions, floor-cleaning protocols or chemical exposures



B-518 with lower adhesion for clean, polished floors

Catalog #	Surface Type	Style	Size	Qty
148820	Smooth Flooring	Line	2 in.	100 ft. roll
148808	Smooth Flooring	Line	2 in.	500 ft. roll
148814	Smooth Flooring	Line	3 in.	100 ft. roll
148819	Smooth Flooring	Line	3 in.	500 ft. roll
148806	Smooth Flooring	Line	4 in.	100 ft. roll
148816	Smooth Flooring	Line	4 in.	500 ft. roll
148815	Smooth Flooring	Dashed	2 in. x 8 in.	100 ft. roll
148823	Smooth Flooring	Dashed	2 in. x 8 in.	500 ft. roll



B-519 with higher adhesion for dull or worn surfaces

Catalog #	Surface Type	Style	Size	Qty
148813	Rough Flooring	Line	2 in.	100 ft. roll
148822	Rough Flooring	Line	2 in.	500 ft. roll
148809	Rough Flooring	Line	3 in.	100 ft. roll
148821	Rough Flooring	Line	3 in.	500 ft. roll
148810	Rough Flooring	Line	4 in.	100 ft. roll
148807	Rough Flooring	Line	4 in.	500 ft. roll
148812	Rough Flooring	Dashed	2 in. x 8 in.	100 ft. roll
148818	Rough Flooring	Dashed	2 in. x 8 in.	500 ft. roll



Paint vs. ToughStripe Tape

	Preparation and Execution	Environment	Removal	Brady Solutions	
<p>Tape</p>	Requires less planning and preparation. Tape immediately bonds to floor.	Indoor, dry environments	Easier to remove if markings need to be rearranged	Good: B-726 Vinyl Tape Better: ToughStripe Tape Best: ToughStripe Max Tape	Cost-effective solution for short application periods Longer application period and available in die-cuts and signs Highest durability for forklift traffic
<p>Paint</p>	Extensive surface preparation, ventilation and control of ignition or contamination sources. Downtime for drying.	Indoor and outdoor use, including wash down environments	Difficult to remove if markings need to be rearranged	PaintStripe™ Floor Marking Stencil	Paint stencil for longer, more permanent marking on rough or pitted floors

Facility Marking Tape

BradyID.com/s36



Aisle Marking Tapes

- Long-wearing B-726 vinyl tape
- Applies quickly and sticks tightly
- Not compatible with Universal Line Applicator

Color	2 in. x 36 yd.	3 in. x 36 yd.	4 in. x 36 yd.
Yellow	58200	58250	102838
Red	58201	58251	102836
Orange	102825	102829	102835
White	58203	58253	102837
Green	58202	58252	102834
Blue	58220	58221	102833
Black	58222	58223	102839
Brown	102828	102832	102840
Purple	102827	102831	-
Grey	102826	102830	-



L-Shaped Corner Markings

- Use corner marks to quickly define storage locations on workbenches, desktops and shelves

Catalog #	Color	Size	Qty.
121415	Yellow	1 in. x 1 in.	750/roll
121413	Red	1 in. x 1 in.	750/roll
121416	Green	1 in. x 1 in.	750/roll
121414	Blue	1 in. x 1 in.	750/roll
121417	Black	1 in. x 1 in.	750/roll



Border Marking Tape

- Ideal for solid borders, dividing lines
- Place color-coded bands on tools for easy identification

Catalog #	Color	Size
121124	Yellow	0.25 in. x 50 ft.
121129	Yellow	0.50 in. x 50 ft.
121122	Red	0.25 in. x 50 ft.
121127	Red	0.50 in. x 50 ft.
121125	Green	0.25 in. x 50 ft.
121130	Green	0.50 in. x 50 ft.
121128	Blue	0.25 in. x 50 ft.
121123	Blue	0.50 in. x 50 ft.
121126	Black	0.25 in. x 50 ft.
121131	Black	0.50 in. x 50 ft.



Warning Tape

- B-950 vinyl with permanent adhesive stands up to tough indoor conditions
- Colors sealed beneath protective layer of abrasion resistant clear vinyl

Color	1 in. x 18 yd.	1.5 in. x 18 yd.	2 in. x 18 yd.	3 in. x 18 yd.
Striped Tape				
Blk/Ylw	55300	55301	55302	55303
Rd/Wht	55294	55295	55296	55297
Blk/Wht	55290	55291	55292	55293
Mag/Ylw	-	55312	55313	55314
Grn/Wht	-	-	90019	90020
Checked Tape				
Blk/Ylw	-	-	76317	76319
Blk/Wht	-	-	76316	76318



T-Shaped Corner Markings

- Use corner marks to quickly define storage locations on workbenches, desktops and shelves

Catalog #	Color	Size	Qty.
121420	Yellow	1.5 in. x 1 in.	545/roll
121418	Red	1.5 in. x 1 in.	545/roll
121421	Green	1.5 in. x 1 in.	545/roll
121419	Blue	1.5 in. x 1 in.	545/roll
121422	Black	1.5 in. x 1 in.	545/roll



Shadow Vinyl Rolls

- Quickly and easily create tool shadows to exact size and shape
- Simply place tool on vinyl, trace outline with pen and cut out with scissors

Catalog #	Color	Size
121119	Yellow	12 in. x 12 ft.
121117	Red	12 in. x 12 ft.
121120	Green	12 in. x 12 ft.
121118	Blue	12 in. x 12 ft.
121121	Black	12 in. x 12 ft.



Reflective Tape

- Made of B-957 reflective tape
- Gives an extra margin of safety in low light conditions

Color	2 in. x 15 ft.	2 in. x 30 ft.	3 in. x 15 ft.	3 in. x 30 ft.
Solid Tape				
Yellow	78986	78141	78988	78144
Orange	78989	78142	78990	78145
White	78985	78140	78987	78143
Striped Tape				
Blk/Ylw	76308	78130	76312	78133
Rd/Wht	76309	78131	76313	78134
Blk/Wht	76310	78132	-	78135
Checked Tape				
Blk/Ylw	76321	78137	-	78139
Blk/Wht	-	78136	-	78138



Organize tools and equipment



Designate storage locations



Inventory and reorder levels



Warn of safety hazards

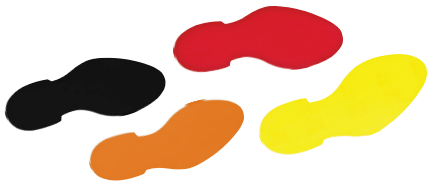

Footprints

- Single footprints made of vinyl and designed for easy hand application

Catalog #		Color	Size	Qty.
Left Foot	Right Foot			
121405	121406	Yellow	12 in.	1 ea.
121402	121401	Orange	12 in.	1 ea.
121409	121410	Red	12 in.	1 ea.
121411	121412	White	12 in.	1 ea.
121407	121408	Green	12 in.	1 ea.
121400	121399	Blue	12 in.	1 ea.
121404	121403	Black	12 in.	1 ea.



Vinyl Aisle Marking Dots

- B-7569 aisle marking vinyl dots are designed for easy hand application

Catalog #	Color	Size	Qty.
121033	Yellow	2 in. dia.	500
121034	Yellow	3 in. dia.	500
121035	Yellow	4 in. dia.	500
121036	Yellow	5 in. dia.	500
121039	Red	2 in. dia.	500
121139	Red	3 in. dia.	500
121040	Green	2 in. dia.	500
121041	Green	3 in. dia.	500
121042	White	2 in. dia.	500
121043	White	3 in. dia.	500

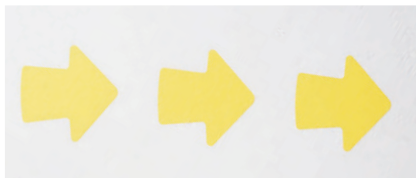

Vinyl Aisle Marking Arrows

- B-7569 vinyl is ideal for floor application
- Aisle marking arrows are designed for easy hand application

Catalog #	Color	Size	Qty.
121046	Yellow	2 in.	100
121047	Yellow	3 in.	100
121048	Yellow	4 in.	100
121049	Yellow	5 in.	100
121051	Red	3 in.	100



Removable Footprints

- Durable, skid-resistant footprints with removable back
- Standard package: 5 left and 5 right

Catalog #	Color	Size	Qty.
31550	Yellow	11.875 in. x 3.75 in.	5 sets
31553	Red	11.875 in. x 3.75 in.	5 sets
31551	Green	11.875 in. x 3.75 in.	5 sets
31552	Blue	11.875 in. x 3.75 in.	5 sets



Roll Mounted Dots

- B-7569 vinyl dots are designed for machine application

Catalog #	Color	Size	Qty.
121037	Yellow	2 in. dia.	1,000/roll
121038	Yellow	3 in. dia.	1,000/roll
121044	White	2 in. dia.	1,000/roll
121045	White	3 in. dia.	1,000/roll
121050	Green	3 in. dia.	1,000/roll



Glow-In-The-Dark Arrows

- Photoluminescent arrows designed to direct safe exit during power outages and emergency situations
- 10+ hour glow life

Catalog #	Description	Size	Qty.
93275	Glow Arrows	3 in.	100



Glow-In-The-Dark Footprints

- Photoluminescent footprints designed to direct safe exit during power outages and emergency situations
- 10+ hour glow life

Catalog #	Description	Size	Qty.
55358	Left Footprint	12 in.	1 ea.
55359	Right Footprint	12 in.	1 ea.



Color-Coded Dots

- Pressure-sensitive paper labels are ideal creating a visual workplace

Catalog #	Color	Size	Qty.
30664	Yellow	1.5 in. dia.	500
30668	Yellow	3 in. dia.	500
30662	Red	1.5 in. dia.	500
30666	Red	3 in. dia.	500
30663	Green	1.5 in. dia.	500
30667	Green	3 in. dia.	500
30661	Blue	1.5 in. dia.	500
30665	Blue	3 in. dia.	500

* Dispensers not included



Write-On Magnetic Labels

- Reuseable labels with a water-soluble pen that wipes off with a wet cloth

Catalog #	Color	Size
56962	Yellow	1 in. x 50 ft.
56959	Orange	1 in. x 50 ft.
56960	Red	1 in. x 50 ft.
56961	White	1 in. x 50 ft.
56958	Green	1 in. x 50 ft.
56957	Blue	1 in. x 50 ft.

Facility Marking Tape

BradyID.com/s36



Warning Message Tapes

- B-950 vinyl with permanent adhesive
- Colors sealed beneath protective layer of abrasion resistant clear vinyl

Catalog #	Legend	Size
58255	Caution w/ Stripes	3 in. x 60 ft.
58257	Stripes Only	3 in. x 60 ft.

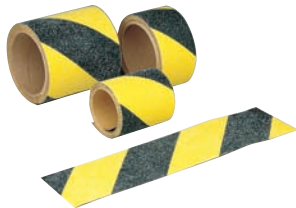

Anti-Slip Striped Tape

- Rugged B-916 adhesive-backed polyester tape coated with durable aluminum oxide grit is ideal for indoor and outdoor use

Catalog #	Size	Qty
78146	1 in. x 60 ft.	1 roll
78147	2 in. x 60 ft.	1 roll
78148	3 in. x 60 ft.	1 roll
78149	4 in. x 60 ft.	1 roll
78150	6 in. x 60 ft.	1 roll



Anti-Slip Floor Tape

- B-916 adhesive-backed polyester tape coated with aluminum oxide grit
- Bonds permanently to clean, dry floors both indoors and outdoors

Color	1 in. x 60 ft.	2 in. x 60 ft.	4 in. x 60 ft.	6 in. x 60 ft.	12 in. x 60 ft.
Blk	78189	78190	78191	78193	78194
Rd	78197	78198	78199	-	-
Ylw	-	78091	78092	-	-
Wht	-	78187	-	-	-
Clear	-	78188	-	-	-



Heavy Duty Anti-Slip Tapes

- Aggressive adhesive withstands harsh elements such as oil, fuel and grease
- High slip resistance with deeply textured silicon carbide grit
- Ideal on loading docks and ramps

Catalog #	Size	Qty
110020	2 in. x 60 ft.	1 roll
110019	4 in. x 60 ft.	1 roll
110018	6 in. x 60 ft.	1 roll
110017	12 in. x 60 ft.	1 roll



Anti-Slip Hazard Marking

- Made of B-819 matte anti-slip overlamine

Catalog #	Legend	Size
92414	Caution	3 in. x 54 ft.
92415	Caution / Do Not Enter	3 in. x 54 ft.
92416	Caution / Watch Your Step	3 in. x 54 ft.
92417	Stripes Only	3 in. x 54 ft.



Anti-Slip Hazard Cleats

- Durable grit-coated polyester die-cuts
- Ideal for use on steps and in entryways

Catalog #	Legend	Size	Qty.
78160	Caution	6 in. x 24 in.	24
78163	Watch Your Step	6 in. x 24 in.	24



Safety Track® Resilient Tape

- Kinder, gentler product without sacrificing performance
- Easily cleaned through mopping

Catalog #	Size	Color	Qty.
98455	4 in. x 60 ft.	Black	1 roll
98459	4 in. x 60 ft.	Gray	1 roll
98457	6 in. x 24 in.	Black	50 cleats



Anti-Slip Die-Cut Cleats

- Durable grit-coated polyester die-cuts

Catalog #	Legend	Size	Qty.
78161	Reflective Stripe	6 in. x 24 in.	24
78162	Photo-lum Stripe	6 in. x 24 in.	24
78195	Black	6 in. x 24 in.	50
78196	Black	5.5 in. x 5.5 in.	50

Egress Marking

The 2015 versions of the International Building Code (IBC), International Fire Code (IFC) and the National Fire Protection Agency's (NFPA) 101 Life Safety Code contain new provisions for the means of egress in most new and pre-existing buildings with five or more stories.

Luminous (glow-in-the-dark) egress path markings are now required for the full width of every stair and handrail, among other markings. Brady offers a complete line of egress marking products that meet the current requirements for the 2015 means of egress regulations.



BradyGlo™ Floor Tapes

- B-324 phosphorescent surface printed polyester
- Designed to safely mark egress pathways during power outages and emergencies
- 10+ hours of glow life

Catalog #	Size	Color
76430	Striped Tape	2 in. x 15 ft.
76431	Striped Tape	3 in. x 15 ft.
76432	Solid Tape	2 in. x 15 ft.
76433	Solid Tape	3 in. x 15 ft.



High Intensity Marking Tape

- Self-sticking polyester in NYC approved styles
- Ideal for marking steps and landings, door frames and handrails
- 10+ hours of glow life

Catalog #	Size	Color
81873	NYC Approved Marking Tape	1 in. x 50 ft.
81729	NYC Approved Anti-Slip Tape	1 in. x 50 ft.



High Intensity Obstacle Tape

- Self-sticking polyester in NYC approved styles
- Clearly marks obstacles that protrude into the egress path
- 10+ hours of glow life

Catalog #	Style	Size
81869	NYC Approved Obstacle Tape	1 in. x 50 ft.



BradyGlo™ Arrow Tape

- Exceeds ASTM E 2072-00 standard
- Designed to safely mark egress pathways during power outages and emergencies
- 10+ hours of glow life

Catalog #	Style	Size
90971	V-Arrow Tape	2 in. x 15 ft.
90972	V-Arrow Tape	3 in. x 15 ft.
90973	Arrow Tape	2 in. x 15 ft.
90974	Arrow Tape	3 in. x 15 ft.
76430	Striped Arrow	2 in. x 15 ft.

Regulations

OSHA 29 CFR 1910.1030 Bloodborne Pathogens:

Labels required for containers and shipments. Employers to post biohazard signs at the entrance to work areas.

DOT 49 CFR 172.400(b):

Labeling is required for infectious substances which meets one or more hazard classifications.

UN2814 Infectious Substances:

Ebola virus defined as Category A infectious substance.

Biohazard Identification

An essential step towards safety is the clear and instantly-readable identification of all biohazard areas and waste products.



Biohazard Labels

- Labels effectively identify and warn of biohazard materials

Catalog #	Size	Qty
LH625E	4 in. x 2.875 in.	25/pk.



Biohazard Waste Disposal Bags

- 3-mil polyethylene bags to package and dispose of biohazardous waste

Catalog #	Size	Qty
145586	16 x 14 x 36 in.	100/pk
145587	30 x 14 x 39 in.	100/pk



Biohazard Tape

- Self-sticking vinyl tape is ideal for clearly identifying biohazard areas

Catalog #	Size	Qty
88051	2 in. x 108 ft.	1 roll



Clearly identify hazardous areas with Brady Biohazard Signs available on page 445.

Barricade Tape

BradyID.com/s36



Woven Barricade Tape

- Made of B-903 polypropylene
- Contains ultraviolet inhibitors for permanent outdoor marking

Catalog #	Size	Color
91172	0.75 in. x 150 ft.	Black/Yellow
91173	0.75 in. x 150 ft.	Magenta/Yellow
91175	0.75 in. x 150 ft.	Black/Red
91176	2 in. x 200 ft.	Black/Yellow
91179	2 in. x 200 ft.	Black/Red



Reinforced Barricade Tape

- Provides fast, on-the-spot warning
- 250-lbs. tensile strength
- Standard package: one roll

Catalog #	Legend	Size
91100	Caution/Cuidado	3 in. x 500 ft.
91101	Caution Construction Area	3 in. x 500 ft.
91102	Caution Do Not Enter	3 in. x 500 ft.
91103	Caution Men Working	3 in. x 500 ft.
91104	Striped	3 in. x 500 ft.



Re-Pulpable Barricade Tape

- Made of 100% strong woven, biodegradable cotton material
- Tape will break down if accidentally introduced into the system

2 in. x 150 ft.	3 in. x 150 ft.	Legend	Color
91082	91083	Caution	Blk/Ylw
91086	91084	Danger	Blk/Red
-	91087	Danger Do Not Enter	Blk/Ylw
-	91085	Danger Do Not Enter	Blk/Red



Economy Barricade Tape

- Made of lightweight non-adhesive polyethylene
- Ideal for temporary use outdoors or permanent indoor warning

Catalog #	Size	Qty.
91228	1 in. x 100 ft.	1 roll
91237	1 in. x 500 ft.	1 roll
91229	2 in. x 200 ft.	1 roll
91238	3 in. x 500 ft.	1 roll

Regulations

Safety Color Code for Marking Physical Hazards 1910.144(a):

Use yellow and black for physical hazards, red and white for fire protection equipment, black and white for traffic and housekeeping markings, magenta and yellow for radiation hazards.



Tape sold separately

Tape Tender

- Dispenses any 2 in. or 3 in. plastic tape rolls up to 1,000 ft.
- Tape advances as needed using thumb
- Steel cutting blade cuts fast and smooth

Catalog #	Legend	Qty.
72412	Tape Tender	1

Facility Marking Tape



Barricade Tape

- Non-adhesive B-912 Polyethylene tapes provide fast, on-the-spot warning
- Use for temporary outdoor or permanent indoor use
- Lightweight tape can be tied, stapled or nailed to posts, fences or metal barricades
- Custom legends also available

3 in. x 200 ft.	3 in. x 1000 ft.	Legend	Color
91468	91462	Authorized Personnel Only	Blk/Ylw
91214	91454	(Blank - Blk/Yellow Stripes Only)	Blk/Ylw
91212	-	Caution	Blk/Ylw
91447	91448	Caution Biohazard	Blk/Org
91469	91463	Caution Chemical Hazard	Blk/Ylw
91217	91453	Caution Construction Area	Blk/Ylw
91224	91451	Caution Do Not Enter	Blk/Ylw
91220	91458	Caution High Voltage	Blk/Ylw
91215	91452	Caution Men Working	Blk/Ylw
91227	91457	Caution Open Trench	Blk/Ylw
91470	91464	Caution Radiation Hazard	Mag/Ylw
91256	91257	Confined Space Do Not Enter	Blk/Ylw
91200	91201	Danger	Blk/Red
91213	91455	Danger	Blk/Ylw
91255	91456	Danger Asbestos Dust Hazard	Blk/Ylw
-	102823	Danger Asbestos Dust Hazard (w/Stripes)	Blk/Red/Wht
-	102822	Danger Confined Space (w/Stripes)	Blk/Red/Wht
-	101349	Danger Keep Out	Blk/Red
102821	-	Do Not Enter (w/Stripes)	Blk/Red
102824	-	Do Not Enter	Blk/Red



Pennant Barricade Tape

- Tough and durable flag barricade can be used repeatedly
- Pennants are 18 in. x 18 in. and spaced evenly across tape

Catalog #	Description
58388	83 ft. with 15 Pennants
58389	113 ft. with 25 Pennants



Biodegradable Flagging Tape

- Made of 70% wood fiber
- Non-toxic; will not harm wildlife, livestock or the environment
- Complete degradation will occur in 6-12 months

Catalog #	Legend	Size	Color
91090	Caution	3 in. x 150 ft.	Blk/Ylw
91091	Caution Do Not Enter	3 in. x 150 ft.	Blk/Ylw
91092	Caution Men Working Overhead	3 in. x 150 ft.	Blk/Ylw
91088	Danger	3 in. x 150 ft.	Blk/Rd
91089	Danger Do Not Enter	3 in. x 150 ft.	Blk/Rd



Flagging Tape

- Flag boundary stakes, trees and hazardous areas
- Non-adhesive

Catalog #	Size	Color
58347	1.187 in. x 300 ft.	Yellow
58342	1.187 in. x 300 ft.	White
58343	1.187 in. x 300 ft.	Green
58344	1.187 in. x 300 ft.	Orange
58345	1.187 in. x 300 ft.	Blue
58346	1.187 in. x 300 ft.	Red
58348	1.187 in. x 150 ft.	Fluor. Yellow
58349	1.187 in. x 150 ft.	Fluor. Red
58351	1.187 in. x 150 ft.	Fluor. Blue
58352	1.187 in. x 150 ft.	Fluor. Orange
58353	1.187 in. x 150 ft.	Fluor. Green
58354	1.187 in. x 150 ft.	Fluor. Pink



Identoline® Underground Warning Tape

- Made of heavy-duty B-720 polyethylene
- Tape is 4.0-mil. thick with a tough tensile strength of 1750 psi
- Uses American Public Works Association (APWA) color coding
- Overcoated graphics provide long-lasting legibility and hold color values

Catalog #	Utility Class	Size	APWA Color
63009	Cable T.V.	6 in. x 1,000 ft.	Orange
91295	Electric*	3 in. x 1,000 ft.	Red
91296	Electric	6 in. x 1,000 ft.	Red
91294	Gas	6 in. x 1,000 ft.	Yellow
91299	Sewer	6 in. x 1,000 ft.	Green
91297	Telephone	6 in. x 1,000 ft.	Orange
63050	Reclaimed Water	6 in. x 1,000 ft.	Purple
91298	Water	6 in. x 1,000 ft.	Blue

*Legend appears on one line



Detectable Identoline® Warning Tape

- B-721 metal detectable polyester; foil is 4.5-mils
- Subsurface graphics seal the legend from acids, alkalis and soil substances
- Uses American Public Works Association (APWA) color coding
- Meets OSHA regulation covering location or underground utility lines
- Manual or automatic installation 4 in. to 6 in. below surface for detectability

Catalog #	Utility Class	Size	APWA Color
91601	Electric	2 in. x 1,000 ft.	Red
91606	Fiber Optic	2 in. x 1,000 ft.	Orange
91600	Gas	2 in. x 1,000 ft.	Yellow
91604	Sewer	2 in. x 1,000 ft.	Green
91603	Water	2 in. x 1,000 ft.	Blue



Utility Marking Flags

- Ideal for identifying possible hazards buried underground
- 4 in. x 5 in. flags attached to 30 in. steel rod

Catalog #	Legend	Color	Qty.
98165	Buried Sewer Line	Blk/Grn	100
98166	Buried Cable	Blk/Rd	100
98167	Buried Water Line	Wht/Blu	100
98168	Buried Electric Line	Blk/Rd	100
98169	Buried Fiber Optic Cable	Blk/Org	100
98170	Buried Pipeline	Wht/Blu	100
98171	Buried Gas Line	Blk/Ylw	100
98172	(Blank)	Orange	100
98173	(Blank)	Red	100
98174	(Blank)	Yellow	100
98175	(Blank)	Blue	100
98176	(Blank)	White	100
98177	(Blank)	Green	100
98178	(Blank)	Fluor. Red	100

BradyLink® Warning Post System

- Portable, non-rusting posts and chain for designating restricted areas or to guide foot and forklift traffic pathways
- Made of colorful polystyrene and polyethylene and are a decorative alternative to metal posts
- Non-conductive so can be safely used in electrically hazardous areas. Hollow base can be filled for a more stable application
- Not intended to support heavy weight



Small posts with flat base

Large with dome base

BradyLink Posts

Includes base, top and c-hook for each post

Color	Color	1 pack	6 pack
Small post with flat base			
Black	40 in. tall; 2.5 in. dia. post; 14 in. dia. flat base	80937	80943
Yellow	40 in. tall; 2.5 in. dia. post; 14 in. dia. flat base	80938	80944
Large post with dome base			
Black	41 in. tall; 3 in. dia. post; 16 in. dia. dome base	92116	92119
White	41 in. tall; 3 in. dia. post; 16 in. dia. dome base	92117	92120
Yellow	41 in. tall; 3 in. dia. post; 16 in. dia. dome base	92118	92121
Blk/Ylw Striped	41 in. tall; 3 in. dia. post; 16 in. dia. dome base	92122	92123

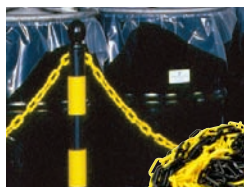

BradyLink Chain

- Polyethylene chain for indoor use only
- Link design prevents kinking

Catalog #	1.5 in. x 100 ft.	2 in. x 100 ft.	3 in. x 100 ft.
Yellow	78234	78238	37860
Black/Yellow	-	78254	37864
White	78235	78239	37861
Black	-	78268	-
Orange	-	78241	-
Yellow/Magenta	-	-	37865



S-Hook

C-Hook

Links, C-Hooks and S-Hooks

- S-hooks temporarily attach lengths of chain together
- C-hooks are installed on the post to allow chain or s-hook to attach to post

Catalog #	Description	Color	Qty.
C-hooks for post tops			
92011	C-hook	Black	36
92010	C-hook	White	36
S-hooks for chain			
78259	2 in. S-hook	Black	36
78257	2 in. S-hook	Yellow	36
78258	2 in. S-hook	White	36
Individual chain links			
78248	2 in. links	Black	36
78246	2 in. links	Yellow	36
78247	2 in. links	White	36



Post Sign Adapter

- Adaptor locks in place on top of BradyLink Warning Posts

Color	Size	1 pack	6 pack
Black	5 in. x 1.75 in.	80958	80960
Black	6 in. x 2 in.	92135	92137
Yellow	5 in. 1.75 in.	80959	80961
Yellow	6 in. x 2 in.	92134	92136



Bradycone™ Warning Cones System

- Designed to communicate temporary slip, trip and fall hazards indoors or outdoors
- Cones are light weight, portable and stackable
- Hazard message is on all four-sides of the cone, so your message can't be missed
- Enhance your message with the Lock-in Sign Frame with pictogram labels



Apply label to the 8.25 in. x 8.25 in. frame face

Bradycone Warning Cones

- Stackable for easy storage
- High impact, weather-resistant cones
- Includes notch at top of cone to attach Bradycone chain (sold separately)

Catalog #	Description	Size
77204	Blank Orange	35 in.
77198	Blank Yellow	25 in.
77205	Blank Yellow	35 in.
103681	Do Not Enter Yellow	35 in.
103682	Icy Areas Yellow	35 in.
103683	No Parking Yellow	35 in.
77201	Safety First Yellow	25 in.
77203	Safety First Yellow	35 in.
77200	Wet Floor Yellow	25 in.
77202	Wet Floor Yellow	35 in.
103680	Wet Floor/ Piso Mojado Yellow	35 in.

Bradycone Accessories

- Accessories to complete your Bradycone Warning System
- Chain can be hooked into cone notch at any position along the chain

Catalog #	Description	Size
77207	Lock-in-Chain	20 in.
77208	Weight Ring	9 lbs.

Bradycone Picto Labels

- Lock-in frame easily fits to the top of the cone
- Self-sticking labels can be applied to the front of the frame

Catalog #	Legend	Size
94917	Falling Ice	8.25 in. x 8.25 in.
77221	Electrical Hazard	8.25 in. x 8.25 in.
77224	No Entry Construction	8.25 in. x 8.25 in.
77217	No Smoking	8.25 in. x 8.25 in.
77219	Out Of Service	8.25 in. x 8.25 in.
77216	Slippery	8.25 in. x 8.25 in.
77226	Watch Your Step	8.25 in. x 8.25 in.
77210	Lock-in-Frame	10 in. x 10 in.



Traffic Cones

- Vinyl construction assures flexible, yet rugged durability

Catalog #	Description	Size	Qty.
80111	Traffic Cone	18 in.	1
80112	Traffic Cone	24 in.	1



Traffic Cone Signs

- Easy to install plastic sign fits any standard traffic cone or delineator
- Legend on one side only

Catalog #	Legend	Size	Qty.
80117	Do Not Enter	10.5 in. x 12.75 in.	1
80118	Wet Floor	10.5 in. x 12.75 in.	1



Construction Barricades on page 581

Barricades / Security

BradyID.com/s36

Reversible Floor Stands

- Reversible signs contain two legends; to change legend simply detach at the bottom and flip over
- Lightweight corrugated material makes it portable and easy to handle
- 12 in. x 20 in. when closed



SIDE A SIDE B
92280



SIDE A SIDE B
92281



SIDE A SIDE B
92285



SIDE A SIDE B
92286



SIDE A SIDE B
92284



Side A Side B
92283



SIDE A SIDE B
92282



SIDE A SIDE B
92288



SIDE A SIDE B
92289

Facility Marking Tape



Floor Stands

- Made of durable polystyrene plastic
- Printing appears on both panels

Catalog #	Legend	Size
47243	Caution Tripping Hazard	12 in. x 20 in.
47239	Danger Persons Working Above	12 in. x 20 in.
47251	Notice Restroom Closed For Cleaning	12 in. x 20 in.



Heavy Duty Floor Stands

- Alert employees and visitors of potential floor hazards
- Made of heavy-duty polypropylene
- Wording appears on both panels

Catalog #	Legend	Height
104808	Blank	24.5 in.
104810	Caution	24.5 in.
104811	Closed	24.5 in.
104809	Wet Floor	24.5 in.





Bradystake™ Warning Stakes

- Bradystake Warning Stakes are ideal for outdoor marking applications
- Rugged and flexible stakes bend, not break, if accidentally run over with a vehicle
- Stakes are available in highly visible standard APWA colors and reflective stripes so they are easy to see. Their durable graphics are ideal for harsh environments and because they are flat on both sides you get two-way readability
- Stakes are six times lighter than conventional signs and posts, so installation is easy and shipping costs are greatly reduced

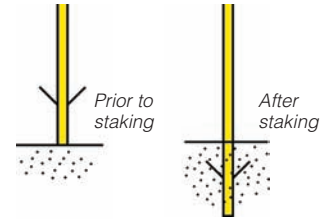
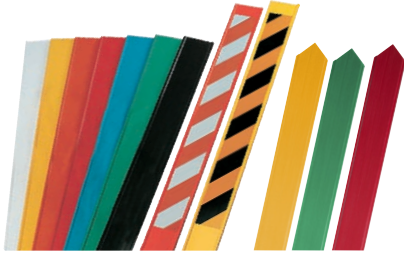

Bradystake Warning Stakes

- Rugged and flexible reinforced polymer
- Stakes available with pointed end to help drive stake into ground
- Blank stakes with no sign assembly

Catalog #	Description	Color	Size
Stakes with pointed end			
96950	Pointed end	Orange	3.75 in. x 66 in.
96951	Pointed end	Yellow	3.75 in. x 66 in.
96952	Pointed end	Blue	3.75 in. x 66 in.
96953	Pointed end	Green	3.75 in. x 66 in.
96954	Pointed end	White	3.75 in. x 66 in.
96955	Pointed end	Red	3.75 in. x 66 in.
Stakes with square end			
96920	Square end	Orange	3.75 in. x 66 in.
96921	Square end	Yellow	3.75 in. x 66 in.
Striped reflective stakes			
96922	Reflective	Org/Wht	3.75 in. x 66 in.
96923	Reflective	Blk/Ylw	3.75 in. x 66 in.

Bradystake Labels

- B-302 self-sticking polyester suitable for outdoor use
- 1 in. blank area at bottom accommodates a company label
- Labels can also be custom ordered with your own legend

Catalog #	Legend	Size
85406	Caution Gas Pipeline	14 in. x 3 in.
85551	Warning Natural Gas Pipeline	14 in. x 3 in.

Bradystake Anchors

- Anchors catch soil around the stake adding extra stability when used in loose or sandy soil
- Resilient, long-lasting spring steel withstands outdoor conditions
- Can be custom ordered to be applied to stakes at the factory allowing for quick field installation

Catalog #	Description	Qty
97084	Bradystake Anchors	1



TensabARRIER™ Barricades

- 40 in. post with 14 in. dia. (26 lb.) base
- Pull-out belt is 7.5 ft. long

Catalog #	Legend
80125	Post with Black / White Stripe Belt
80127	Post with Black / Yellow Caution - Do Not Enter Belt
58413	Wall-Mount End



TensabARRIER Signs

- Made of durable plexiglass
- 11 in. x 7 in. sign feature white letters on black background

Catalog #	Legend
80129	Please Wait Here For Next Available Teller
80130	Please Wait Here For Next Available Clerk
80131	Please Wait Here For Next Available Agent



Convex

Half Dome

Safety Mirrors

- Impact-resistant plastic mirrors improve visibility and safety by providing a wide or field of vision
- Mounting hardware included

Catalog #	Description	Size
86341	Indoor Convex	18 in.
86340	Indoor Convex	26 in.
86344	Full Dome 360°	48 in.
86342	Half Dome 180°	18 in.
86343	Quarter Dome 90°	18 in.

Security Seals

BradyID.com/s36



Metal Ball Seals

- Supplied with embossed consecutive numbering (factory specified) and the word SEALED
- Available with or without rolled edges to help prevent accidental cuts

Catalog #	Description	Qty.
95197	Metal Ball Seals	100
95198	Rolled Edge Metal Ball Seals	100



Bradylock™ Fastener

- Self-locking heavy duty plastic fastener for Strap-On Markers
- Excellent chemical resistance

Catalog #	Description	Size
41772	Bradylock Fastener	0.5 in. x 150 ft.



Colored Nylon Ties

- Easily secure valve tags

Catalog #	Description	Length	Qty.
98848	Black	8 in.	100
98850	Green	8 in.	100
98853	Purple	8 in.	100
98851	Natural	8 in.	100
98854	Red	8 in.	100
98855	Yellow	8 in.	100
98849	Blue	8 in.	100

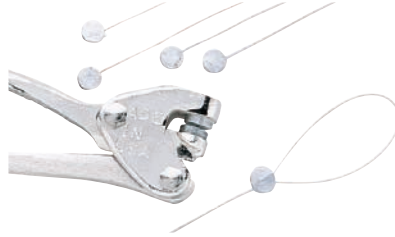

Lead Seals and Press

- 12 in. wire with pre-fitted lead seals fit easily around pipes or valves
- Quickly and permanently crimp your lead seals with Brady's own hand sealer.

Catalog #	Material	Size	Qty.
23301	Copper	12 in. length 31 gauge 7/16 in. dia.	250
23302	Monel Lead	12 in. length 31 gauge 7/16 in. dia.	250
23300	Hand Sealing Press		1



Plastic Truck Seals

- Deters entry, yet easily removed
- Tamper-resistant truck seals are embossed with the word SEAL and are consecutively numbered
- Ships in mats of ten for convenience and accountability; 100 seals total

Catalog #	Size	Color	Qty.
95193	7.5 in.	Blue	100
95195	7.5 in.	Red	100
95196	7.5 in.	Yellow	100
133487	7.5 in.	Green	100
133488	7.5 in.	Orange	100



Quik-Applied™ Nylon Straps

- Can be used with a variety of tags including valve and lockout tags

Catalog #	Strap Length	Qty
91165	6 in.	10/pk
91166	7 in.	10/pk

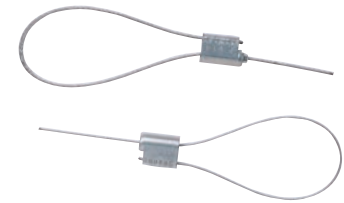

Cable Lock Seals

- Heavy steel seals have a steel head with 6 serialized numbers for inventory or tracking
- Factory chooses the starting number

Catalog #	Description	Tensile Strength	Qty.
95166	12 in. x 1/16 in.	727 lbs.	100
95167	12 in. x 3/32 in.	727 lbs.	100



Padlock Plastic Seals

- Made of durable polypropylene with galvanized wire hasps
- Seal body will blush if tampered with
- Heat stamped with SEAL and a 7-digit sequence number (factory specified)

Catalog #	Color	Qty.
95168	Black	100/pk*
95174	White	100/pk*
95173	Red	100/pk*
95172	Orange	100/pk*
95170	Gray	100/pk*
95171	Green	100/pk*
95169	Blue	100/pk*
95175	Yellow	100/pk*

* Minimum order: 5pks



Nylon Fasteners

- Nylon fastener styles available to meet every application

Catalog #	Description	Qty.
81761	8 in. Reusable Beaded Ties	100/pk
81762	7 in. Nylon Fasteners	100/pk



Stainless Steel Wire

- 32 mil stainless steel safety wire
- Recommend to be used with wire twister pliers

Catalog #	Description	Length
15424	Stainless Steel Safety Wire	1,800 ft



Stainless Steel Strapping

- Type 316 Stainless Steel Strapping is highly corrosion and heat resistant

Catalog #	Description	Qty
42331	0.25 in. Stainless Steel Strapping	100 ft.
42332	0.25 in. Stainless Steel Strapping	250 ft.



Banding Heads

- Use with 0.25 in. continuous stainless steel strapping to create secure closures

Catalog #	Description	Qty.
90910	Stainless Steel Banding Heads	100

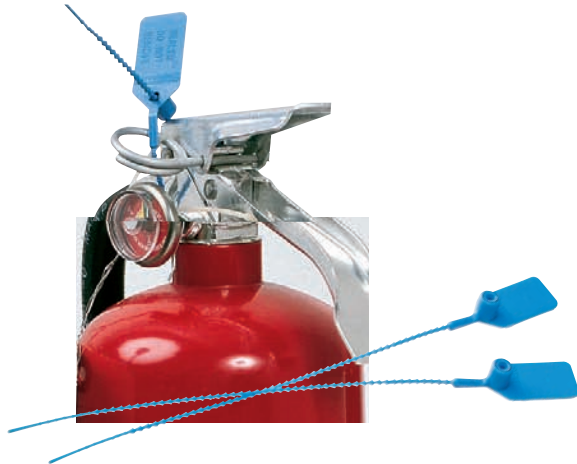

Pull-Tite Seals

- One of the few security seals approved for use by Underwriter's Laboratories (UL) for fire extinguishers and safety doors
- Ideal for use with courier pouches, canisters or cabinets that contain valuables or sensitive documents
- Pull-Tite Seals are embossed SEALED DO NOT REMOVE
- Breaking strength of 10-14 pounds

Catalog #	Size	Color	Qty.
UL approved for fire extinguishers and safety doors			
95150	9 in.	Red	100
95155	9 in.	Yellow	100
95143	9 in.	Light Blue	100
95144	9 in.	Green	100
95141	9 in.	Black	100
Non-UL approved			
133485	9 in.	Orange	100
133482	9 in.	Red	100
133483	9 in.	Yellow	100
133484	9 in.	Light Blue	100
133481	9 in.	Green	100
133486	9 in.	White	100

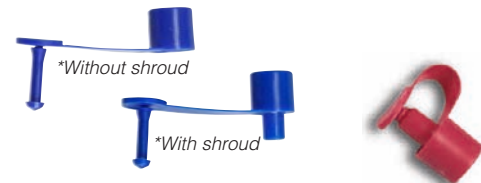

Ring-Loc Drum™ Seals

- Specifically designed to ensure fiber drum integrity
- Available in two materials:
Nylon which affords greater strength
Polypropylene will blush if tampered
- Hand applied seals can be removed with a simple cutting tool

Catalog #	Description	Color	Qty.
Nylon			
95158	Nylon w/ Shroud	Blue	100
95159	Nylon w/o Shroud	Blue	100
95161	Nylon w/ Shroud	Red	100
95160	Nylon w/o Shroud	Red	100
Polypropylene			
95162	Polypropylene w/ Shroud	Blue	100
95163	Polypropylene w/o Shroud	Blue	100
95164	Polypropylene w/ Shroud	Red	100
95165	Polypropylene w/o Shroud	Red	100

Security Badges

BradyID.com/s36



SecurAlert™ Clip-On Badges

- Low cost clip-on alternative to self-adhesive badges
- 3 in. x 3 in. slotted cards
- 500 front and back sets per pack

	Visitor	Contractor	Temporary
Badge expires after 1 day			
Red	95643	95653	95663
Blue	95644	95654	95664
Yellow	95645	95655	95665
Green	95646	95656	95666
White	95647	95657	95667
Badge expires after 1 week			
Red	95648	95658	95668
Blue	95649	95659	95669
Yellow	95650	95660	95670
Green	95651	95661	95671
White	95652	95662	95672

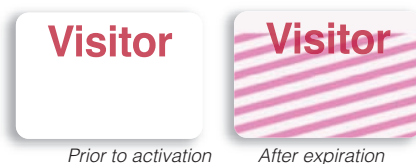

One Step SecurAlert™ Badges

- Pre-assembled for your convenience
- Activated by removing the liner between the front and back of badge
- Badges expire after 24 hours
- 500 front and back sets per pack

Catalog #	Legend	Size	Qty.
95635	Visitor	2 in. x 3 in.	500



SecurAlert™ Adhesive Badges

- Activate expiration by applying the front badge to the back badge
- Badges expire after 24 hours
- 500 front and back sets per pack

Catalog #	Legend	Expires In	Qty.
95689	Contractor	24 hours	500
95674	Contractor	1 week	500
95690	Temporary	24 hours	500
95675	Temporary	1 week	500
95688	Visitor	24 hours	500
95673	Visitor	1 week	500

Facility Security



Retractable Badge Holder

- Clip attaches to belt or pocket while the heavy-duty nylon cable with fastener attaches to badge
- An ideal alternative to bull dog clips which may damage clothing

Catalog #	Description	Color	Qty.
95071	Retractable Holder	Blue	1
95072	Retractable Holder	Red	1
95073	Retractable Holder	White	1
95074	Retractable Holder	Gray	1
95075	Retractable Holder	Black	1



Lanyards

- Reuseable 19 in. cloth lanyard
- Includes a snap-swivel hook and adjustable bead for securing lanyard

Catalog #	Color	Size	Qty.
95090	Blue	19 in.	1
95091	Green	19 in.	1
95092	Orange	19 in.	1
95093	Red	19 in.	1
95094	White	19 in.	1



Security Tyvek® Wristbands

- An economical way to keep track of personnel, patients or visitors
- Will not tear or stretch
- Adhesive closure cannot be reused
- All wristbands are consecutively numbered (factory specified)

Tyvek® is a registered trademark of Dupont

Catalog #	Color	Size	Qty
95097	Red	1 in.	500
95101	Pink	1 in.	500
95099	Yellow	1 in.	500
95102	Orange	1 in.	500
95098	Purple	1 in.	500
95100	Blue	1 in.	500
95103	Green	1 in.	500



Self-Expiring Permits

- Temporary parking permits expire during the day by progressively revealing the letters E-X-P-I-R-E-D.
- Expiration process starts once the self-adhesive cover is applied

Catalog #	Legend	Color	Qty.
Red for Hot Weather Over 80°F (25°C)			
95677	Visitor	5 in. x 3 in.	500
95680	Temporary	5 in. x 3 in.	500
Blue for Moderate Weather 50–80°F (10–25°C)			
95678	Visitor	5 in. x 3 in.	500
95681	Temporary	5 in. x 3 in.	500
Purple for Cold Weather under 50°F (10°C)			
95679	Visitor	5 in. x 3 in.	500
95682	Temporary	5 in. x 3 in.	500

Contact Brady for custom permits with your own logo, color and custom text.

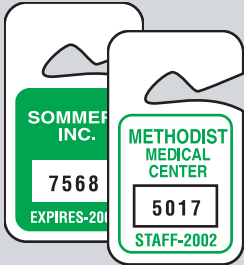

Self-Adhesive Vinyl Windshield Decals

Catalog #	Color	Sequence	Size	Qty.
95199	Blue	001-100	3 in. x 3 in.	100
96230	Blue	101-200	3 in. x 3 in.	100
96231	Blue	201-300	3 in. x 3 in.	100
96232	Blue	301-400	3 in. x 3 in.	100
96233	Blue	401-500	3 in. x 3 in.	100
95200	Red	001-100	3 in. x 3 in.	100
96234	Red	101-200	3 in. x 3 in.	100
96235	Red	201-300	3 in. x 3 in.	100
96236	Red	301-400	3 in. x 3 in.	100
96237	Red	401-500	3 in. x 3 in.	100



Self-Adhesive Vinyl Bumper Decals

Catalog #	Color	Sequence	Size	Qty.
95207	Blue	001-100	4.75 in. x 2.74 in.	100
96246	Blue	101-200	4.75 in. x 2.74 in.	100
96247	Blue	201-300	4.75 in. x 2.74 in.	100
96248	Blue	301-400	4.75 in. x 2.74 in.	100
96249	Blue	401-500	4.75 in. x 2.74 in.	100
95208	Red	001-100	4.75 in. x 2.74 in.	100
96250	Red	101-200	4.75 in. x 2.74 in.	100
96251	Red	201-300	4.75 in. x 2.74 in.	100
96252	Red	301-400	4.75 in. x 2.74 in.	100
96253	Red	401-500	4.75 in. x 2.74 in.	100



Rearview Mirror Hanging Tags

Catalog #	Color	Sequence	Size	Qty.
95201	Blue	001-100	2.75 in. x 4.75 in.	100
96262	Blue	101-200	2.75 in. x 4.75 in.	100
96263	Blue	201-300	2.75 in. x 4.75 in.	100
96264	Blue	301-400	2.75 in. x 4.75 in.	100
96265	Blue	401-500	2.75 in. x 4.75 in.	100
96266	Blue	501-600	2.75 in. x 4.75 in.	100
96267	Blue	601-700	2.75 in. x 4.75 in.	100
96268	Blue	701-800	2.75 in. x 4.75 in.	100
96269	Blue	801-900	2.75 in. x 4.75 in.	100
96270	Blue	901-1000	2.75 in. x 4.75 in.	100
95202	Red	001-100	2.75 in. x 4.75 in.	100
96271	Red	101-200	2.75 in. x 4.75 in.	100
96272	Red	201-300	2.75 in. x 4.75 in.	100
96273	Red	301-400	2.75 in. x 4.75 in.	100
96274	Red	401-500	2.75 in. x 4.75 in.	100
96275	Red	501-600	2.75 in. x 4.75 in.	100
96276	Red	601-700	2.75 in. x 4.75 in.	100
96277	Red	701-800	2.75 in. x 4.75 in.	100
96278	Red	801-900	2.75 in. x 4.75 in.	100
96279	Red	901-1000	2.75 in. x 4.75 in.	100



Rearview Mirror Hanging Tags

Catalog #	Color	Sequence	Size	Qty.
95205	Blue	001-100	4.75 in. x 2 in.	100
96280	Blue	101-200	4.75 in. x 2 in.	100
96281	Blue	201-300	4.75 in. x 2 in.	100
96282	Blue	301-400	4.75 in. x 2 in.	100
96283	Blue	401-500	4.75 in. x 2 in.	100
96284	Blue	501-600	4.75 in. x 2 in.	100
96285	Blue	601-700	4.75 in. x 2 in.	100
96286	Blue	701-800	4.75 in. x 2 in.	100
96287	Blue	801-900	4.75 in. x 2 in.	100
96288	Blue	901-1000	4.75 in. x 2 in.	100
95206	Red	001-100	4.75 in. x 2 in.	100
96289	Red	101-200	4.75 in. x 2 in.	100
96290	Red	201-300	4.75 in. x 2 in.	100
96291	Red	301-400	4.75 in. x 2 in.	100
96292	Red	401-500	4.75 in. x 2 in.	100
96293	Red	501-600	4.75 in. x 2 in.	100
96294	Red	601-700	4.75 in. x 2 in.	100
96295	Red	701-800	4.75 in. x 2 in.	100
96296	Red	801-900	4.75 in. x 2 in.	100
96297	Red	901-1000	4.75 in. x 2 in.	100

PPE Dispensers

BradyID.com/s36



Large Capacity Eye Protection Dispenser

- Clear acrylic unit can be wall or table mounted
- Holds approximately 35 pairs

Catalog #	Description	Size
PD701E	Dispenser	12.25 in. x 18 in. x 9.25 in.



Safety Glasses Holder

- Compact unit holds 4-6 pairs of glasses
- Table top or wall mount use

Catalog #	Description	Size
2011L	Holder w/ cover	3 in. x 9 in. x 6 in. with 6 in. high backplate
2011	Holder w/o cover	3 in. x 9 in. x 6 in. with 6 in. high backplate



Divided Eyewear Dispenser

- White table top dispenser with clear dust cover has two sections in order to dispense two different kinds of eyewear
- Holds approx. 20 pairs

Catalog #	Description	Size
PD264E	Divided Eyewear	11.5 in. x 15.375 in. x 9 in.



Eye Wash Station

- Proper usage instructions printed on the door
- Holds 32 oz. bottle (not included)
- Table top or wall mount use

Catalog #	Description	Size
PD997E	Double Bottle Station	10 in. x 10.25 in. x 7 in.
PD995E	Single Bottle Station	10 in. x 6.25 in. x 7 in.



Towelette Dispenser

- Top loading dispenser has an overflow tray at the bottom
- Table top or wall mount use
- Holds approx. 300 towelettes

Catalog #	Description	Size
LCDISP	Towelette Dispenser	9.75 in. x 7.75 in. x 5 in., 12 in. backplate



Economy Visitor Spec Dispenser

- Holds approx. 20 glasses
- Table top or wall mount use

Catalog #	Description	Size
EHMVSD	Economy Dispenser	17.25 in. x 8 in. x 4 in.

PPE Dispensers



Deluxe Visitor Spec Dispenser

- Tough clear acrylic dispensers have a bottom door that keeps glasses in and folds down for easy dispensing
- Wall mount dispenser holds approx. 20-25 glasses

Catalog #	Description	Size	Color
MVSD	Deluxe Visitor Spec	18 in. x 8 in. x 4 in.	Clear
MVSDL	Deluxe Visitor Spec w/cover	18 in. x 8 in. x 4 in.	Clear
MVSDO	Deluxe Visitor Spec	18 in. x 8 in. x 4 in.	Orange
MVSDG	Deluxe Visitor Spec	18 in. x 8 in. x 4 in.	Green
MVSDM	Deluxe Visitor Spec	18 in. x 8 in. x 4 in.	Mirror



Large Capacity Earplug Dispenser

- Removable inner slanted shelf
- Holds 200 disposable earplugs
- Table top or wall mount use

Catalog #	Description	Size
PD439G	Dispenser	13 in. x 12 in. x 8 in.



Earplug Dispenser

- Removable inner slanted shelf
- Holds 100 to 150 pairs
- Table top or wall mount use

Catalog #	Description	Size
EPD	Earplug Tray	13 in. x 6 in. x 8 in.



Earplug Dispenser

- White acrylic dispenser draws attention to the need to wear ear protection
- Holds approx. 100 pairs
- Table top or wall mount use

Catalog #	Size	Size
EPDISP	Earplug Dispenser	9.75 in. x 7.75 in. x 5 in., 12 in. backplate



Compact Earplug Dispenser

- Cushioned foam bottom
- Table top or wall mount use

Catalog #	Description	Size
2019L	Dispenser w/cover	3 in. x 9 in. x 6 in. with a 6 in. high backplate
2019	Dispenser w/o cover	3 in. x 9 in. x 6 in. with a 6 in. high backplate



Divided Hearing Protection Dispenser

- Two sections allow dispensing of two different kinds of hearing protection
- Table top use only

Catalog #	Description	Size
PD265E	Divided Hearing Protection	11.5 in. x 15.375 in. x 9 in.



Triple Earplug Dispenser

- Blue acrylic dispenser tray features three sections
- Each section holds approx. 50 pairs
- Table top or wall mount use

Catalog #	Description	Size
PD244E	Earplug Tray	10 in. x 12.625 in. x 6.75 in.



Safety Stop Stations

- Safety message and the required PPE needed in one convenient location
- Constructed of durable red and clear acrylic for indoor use
- Mount sign to wall or use as a stand-alone sign (post and base sold separately)

Catalog #	Description	Size	Qty
50914	Sign holds 12 pairs of glasses	36 in. x 18 in. sign	1 each

PPE Dispensers

BradyID.com/s36



Headwear Dispenser

- Middle divider for easy separation
- White acrylic with see-through lid
- Table top only

Catalog #	Description	Size
PD240E	Hairnets	7.5 in. x 10 in. x 6 in.



Headwear Dispenser

- Middle divider for easy separation
- White acrylic with see-through lid
- Table top only

Catalog #	Description	Size
PD241E	Dispenser	11.5 in. x 15.375 in. x 9 in.



Bouffant Cap Dispenser

- Features a front hole and hinged cover for easy dispensing and filling
- Table top or wall mount use

Catalog #	Description	Size
PD524E	Bouffant Cap Dispenser	14 in. x 12 in. x 8 in.
PD325E	Beard Cover Dispenser	14 in. x 12 in. x 8 in.



Glove Dispenser

- The single, double and triple units are all vertically mounted on a wall or counter top

Catalog #	Description	Size
GD01	Single	5 in. x 10.93 in. x 4.12 in.
GD02	Double	10 in. x 10.375 in. x 4.12 in.
GD03	Triple	15 in. x 10.375 in. x 4.12 in.



Deluxe Glove Dispenser

- Dispenser mounts horizontally and allows you to change one box without affecting the others

Catalog #	Description	Size
GD03DL	Deluxe Glove Dispenser	11.812 in. x 20 in. x 4 in.



PPE Dispenser

- 4 in. round front opening for dispensing bouffants, gloves, earplugs, etc.
- Table top or wall mount use

Catalog #	Description	Size
DPE	PPE Dispenser	10 in. x 10 in. x 10 in.

PPE Dispensers



Shoe Cover Dispenser

- Holds over 50 pairs of shoe covers
- Table top or wall mount use

Catalog #	Description	Size
PD322E	Shoe Cover Dispenser	14 in. x 12 in. x 8 in.



Dust Mask Dispenser

- Unique cutout design that allows you to reach in the opening to easily remove
- Holds more than 30 masks

Catalog #	Description	Size
M420	Dust Mask Dispenser	12.5 in. x 6 in. x 6 in.



Finger Cot Dispenser

- White and clear acrylic dispenser with lid helps keep your finger cots clean and ready for use
- Table top or wall mount use

Catalog #	Description	Size
FC1	Finger Cot Dispenser	13 in. x 6 in. x 8 in.

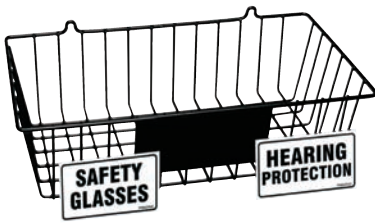

PPE Storage Rack

- Black PVC coated steel rack can hold a variety of items
- Includes one SAFETY GLASSES label and one HEARING PROTECTION label
- Table top or wall mount use

Catalog #	Description	Size
PD001E	Storage Rack	4.5 in. x 15.375 in. x 8.75 in.



PPE Foam-lined Dispenser

- Foam bottom
- Table top or wall mount use

Catalog #	Description	Size
MPPE	Dispenser	9.5 in. x 11.5 in. x 9.5 in.



Clear Dispenser Tray

- Table top or wall mount use

Catalog #	Description	Size
PD205A	Dispenser tray	3 in. x 9 in. x 6 in. with a 6 in. high backplate
PD206A	Tray with lid (not shown)	3 in. x 9 in. x 6 in. with a 6 in. high backplate



Earplug Tray

- Clear acrylic dispenser tray holds a box of your preferred PPE supplies
- Front tray catches spills and protects product dispenser or packaging
- Table top or wall mount use

Catalog #	Description	Size
PD228E	Earplug Tray	10.625 in. x 10.625 in. x 10.625 in.



Towelette Tray

- Attention grabbing red fluorescent acrylic tray holds towelette boxes or other miscellaneous small, frequently used dispenser style boxes
- Table top or wall mount use

Catalog #	Description	Size
PD256E	Towelette Tray	4.5 in. x 6.25 in. x 5.25 in.

PPE Safety Signs

Brady's wide variety of PPE specific safety signs should be used to clearly mark where PPE equipment is required.

View page 529 for all PPE safety signs



Inspection Tags

BradyID.com/s36

new

Brady Inspection Timer

There's a lot going on in your facility. Relying on pen and paper alone to keep it all moving leaves room for gaps in safety and efficiency. Add this innovative Inspection Timer and keep track of your inspection needs at a glance.

It's all in the blinking LED lights that change color to visually indicate how much time you have left before the next inspection. After you've finished your inspection, reset it so you're ready for the next one. With a variety of mounting options and a rugged design you've got an inspection reminder for your tough industrial environments. With this timer, you also get:

- **Impactful and colorful reminders** that break through the grime of your facility
- **Varied timing options** for 7 days, 30 days, 90 days, 6 months and a year
- **Performance in harsh conditions** —IP65 rated so it withstands water, dust, extreme temperatures and more
- **Keeps your inspection timing top of mind** so your facility stays safe, efficient and compliant

Ideal for any location that needs an inspection, including AEDs, fire extinguishers, eyewash stations, forklifts and more



Catalog #	Description	Qty.
150740	7 day inspection timer	10/pack
150741	30 day inspection timer	10/pack
150742	90 day inspection timer	10/pack
150743	180 day inspection timer	10/pack
150744	365 day inspection timer	10/pack



Facility Tags

Universal Tag Holder and Inserts

- Designed for the identification and qualification of lifting equipment, industrial plant, valves, calibration equipment and a variety of other applications
- System provides a clear inspection trail giving integrity and control of work carried out

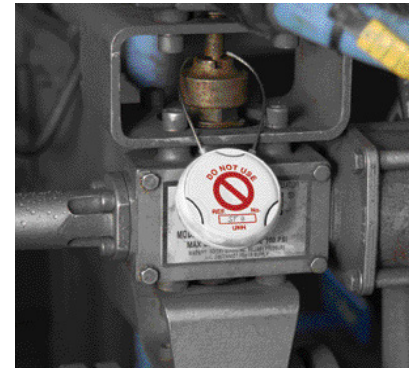

Catalog #	Description	Qty.
UNI-UNH 12 P	Universal Tag Holder Kit w/ 12 in. Plastic Strap	1 kit*
UNI-UNH 6 P STRAP	Universal Tag Holder Kit w/ 6 in. Plastic Strip	1 kit*
UNI-UNH 9 P STRAP	Universal Tag Holder Kit w/ 9 in. Plastic Strip	1 kit*
UNI-UNH PC STRAPS	Universal Tag Plastic Coated Strips	1 kit*
UNI-UNH 9 S	Universal Tag Kit Steel	1 kit*
UNI-UNH S 6 STRAPS	Universal Tag Holder Kit w/ 6 in. Steel Strip	1 kit*

*Kit includes 20 holders, 20 straps and 1 marking pen.



Safe Working Load (SWL)

Catalog #	Size	Color	Qty.
UNI-UNI YELLOW	1.715 in. dia.	Yellow	100/pk
UNI-UNI RED	1.715 in. dia.	Red	100/pk
UNI-UNI BLUE	1.715 in. dia.	Blue	100/pk
UNI-UNI WHITE	1.715 in. dia.	White	100/pk
UNI-UNI GREEN	1.715 in. dia.	Green	100/pk
UNI-UNI ORANGE	1.715 in. dia.	Orange	100/pk
UNI-UNI PURPLE	1.715 in. dia.	Purple	100/pk



Next Inspection Due Date

Catalog #	Size	Color	Qty.
UNI-UNI 503 YELLOW	1.715 in. dia.	Yellow	100/pk
UNI-UNI 503 RED	1.715 in. dia.	Red	100/pk
UNI-UNI 503 B	1.715 in. dia.	Blue	100/pk
UNI-UNI 503 WHITE	1.715 in. dia.	White	100/pk
UNI-UNI 503 GREEN	1.715 in. dia.	Green	100/pk
UNI-UNI 503 ORANGE	1.715 in. dia.	Orange	100/pk
UNI-UNI 503 PURPLE	1.715 in. dia.	Purple	100/pk



Catalog #	Size	Color	Qty.
UNI-UNI 504 YELLOW	1.715 in. dia.	Yellow	100/pk
UNI-UNI BLANK	1.715 in. dia.	Blank	100/pk

NanoTag® Holder and Inserts

- Ideal for the identification and qualification of lifting equipment and is designed to clearly display the Safe Working Load (SWL) or Next Test Date information
- Preprinted empty tag holders alert employees not to use equipment; tag inserts track inspection history and provide other information
- System provides a clear inspection trail giving integrity and control of work carried out



Catalog #	Description	Size	Qty.
NAN-H	Do Not Enter holder	11.25 in x 6 in	1 kit

*Kit includes 20 holders, 40 cable ties and 1 pen.



Safe Working Load (SWL)

Catalog #	Size	Color	Qty.
NAN-NAN YELLOW	1.325 in x 0.7 in	Yellow	100/pk
NAN-NAN RED	1.325 in x 0.7 in	Red	100/pk
NAN-NAN BLUE	1.325 in x 0.7 in	Blue	100/pk
NAN-NAN GREEN	1.325 in x 0.7 in	Green	100/pk
NAN-NAN ORANGE	1.325 in x 0.7 in	Orange	100/pk
NAN-NAN PURPLE	1.325 in x 0.7 in	Purple	100/pk
NAN-NAN WHITE	1.325 in x 0.7 in	Black	100/pk

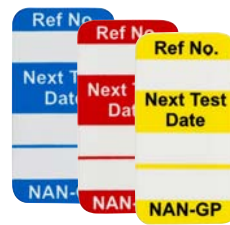

Next Inspection Due Date

Catalog #	Size	Color	Qty.
NAN-GP Y	1.325 in x 0.7 in	Yellow	100/pk
NAN-GP R	1.325 in x 0.7 in	Red	100/pk
NAN-GP B	1.325 in x 0.7 in	Blue	100/pk
NAN-GP G	1.325 in x 0.7 in	Green	100/pk
NAN-GP O	1.325 in x 0.7 in	Orange	100/pk
NAN-GP P	1.325 in x 0.7 in	Purple	100/pk
NAN-GP W	1.325 in x 0.7 in	Black	100/pk

Inspection Tags

BradyID.com/s36

MicroTag® Holder and Inserts

- Ideal for identifying small plant equipment, lifting gear and safety harnesses
- Color coded and date qualified, the system also has the ability to render equipment in a 'prohibition status' should it be found to be faulty between inspection dates.
- Helps meet OSHA regulations for personal fall arrest systems



Catalog #	Description	Size	Color	Qty.
MIC-MTHSTD04	Microtag Kit*	1.5 in x 3.188 in	White	1 kit
MIC-BLANK -FG	Blank Microtag Kit*	1.5 in x 3.188 in	White	1 kit

*Kit includes 20 holders, 40 cables ties and 1 pen

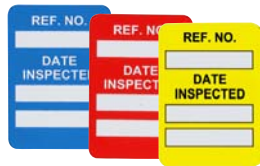

Date Inspected

Catalog #	Color	Qty.
MIC-MTIUSA Y	Yellow	100/pk
MIC-MTIUSA R	Red	100/pk
MIC-MTIUSA B	Blue	100/pk
MIC-MTIUSA G	Green	100/pk
MIC-MTIUSA O	Orange	100/pk
MIC-MTIUSA P	Purple	100/pk
MIC-MTIUSA W	White	100/pk

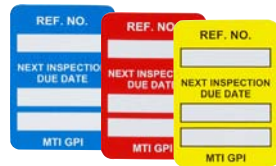

Next Inspection Due Date

Catalog #	Color	Qty.
MIC-MTIGPI Y	Yellow	100/pk
MIC-MTIGPI R	Red	100/pk
MIC-MTIGPI B	Blue	100/pk
MIC-MTIGPI G	Green	100/pk
MIC-MTIGPI O	Orange	100/pk
MIC-MTIGPI P	Purple	100/pk
MIC-MTIGPI W	White	100/pk

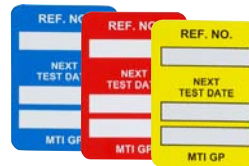

Next Test Date

Catalog #	Color	Qty.
MIC-MTIGP Y	Yellow	100/pk
MIC-MTIGP R	Red	100/pk
MIC-MTIGP B	Blue	100/pk
MIC-MTIGP G	Green	100/pk
MIC-MTIGP O	Orange	100/pk
MIC-MTIGP P	Purple	100/pk
MIC-MTIGP W	White	100/pk



Catalog #	Color	Qty.
MIC-MTI PLAIN	Blank Tag	100/pk
MIC-MTI 500	Hydraulic Tag	100/pk

Scafftag® Scaffolding Tags

- **Heavy-duty Laminated Polyester (LAM)** - Durable polyester laminate tags exceed OSHA's 50-lb. pull force requirement for lockout tagout and include 3/8 in. heavy-duty brass grommets. Nylon ties included.
- **Economy Polyester (POLY)** - Rigid polyester surface exceeds OSHA's 50-lb. pull force requirement for lockout tagout. Tags include 3/8 in. rolled brass eyelets. Nylon ties included.
- **Cardstock (CARD)** - Cardstock tags provide an economical, yet durable, material option. Attachment strings included.



Tag Holder with clear front pocket

- Accommodates 5.75 in. x 3 in. tags

Catalog #	Description	Qty
48111	Holder Only	12 in. x 4.5 in. 1
48112	Holder Kit (holder and 3 tags)	1 kit

86452	5.75 in. x 3 in.	LAM	10/pk
89017	7 in. x 4 in.	LAM	10/pk
86572	5.75 in. x 3 in.	POLY	10/pk
86627	7 in. x 4 in.	POLY	10/pk
86682	5.75 in. x 3 in.	CARD	100/pk

86453	5.75 in. x 3 in.	LAM	10/pk
89018	7 in. x 4 in.	LAM	10/pk
86573	5.75 in. x 3 in.	POLY	10/pk
86628	7 in. x 4 in.	POLY	10/pk
86683	5.75 in. x 3 in.	CARD	100/pk
86738	7 in. x 4 in.	CARD	100/pk

86454	5.75 in. x 3 in.	LAM	10/pk
86502	7 in. x 4 in.	LAM	10/pk
86574	5.75 in. x 3 in.	POLY	10/pk
86629	7 in. x 4 in.	POLY	10/pk
86684	5.75 in. x 3 in.	CARD	100/pk
86739	7 in. x 4 in.	CARD	100/pk

Scafftag® Scaffolding Tags

- Provides system, procedural and legal compliance for scaffolds on worksites
- Provides a clear inspection trail giving integrity and control of work carried out
- Essential for companies working with ISO9000 clients



Catalog #	Description	Size	Color	Qty.
SCAF-STH 132BLA-FG	Holders - Blank	11.75 in x 3.5 in	White	10/pk
SCAF-STH 146BLA-FG	Holders - Blank	11.75 in x 3.5 in	Red	10/pk
SCAF-STH 153	Holders - Eng. / Sp.	11.75 in x 3.5 in	White	10/pk
SCAF-STH 132 SP	Holders - Spanish	11.75 in x 3.5 in	White	10/pk
SCAF-STH 132 FR	Holders - French	11.75 in x 3.5 in	White	10/pk
SCAF-STH132	Holders - English	11.75 in x 3.5 in	White	10/pk
SCAF-STH146	Holders - English	11.75 in x 3.5 in	Red	10/pk
SCAF-STH132A	Standard Kit*	11.75 in x 3.5 in	White	1 kit

Catalog #	Description	Size	Color	Qty.
SCAF-STSI751	Scafftag II Inserts	7.625 in x 5.75 in	Green	100/pk
SCAF2-STHUSA	Scafftag II Holder	11.5 in x 6 in	White	10/pk
SCAF2-STHUSAA	Scafftag II Kit*	11.5 in x 6 in	White	1 kit

*Kits include 10 holders, 20 inserts and 1 pen

*Kits include 10 holders, 20 inserts and 1 pen



SCAF-STSI 601
7.625 in x 3.25 in 100/pk



SCAF-STSI 640
7.625 in x 3.25 in 100/pk



SCAF-STSI 708
7.625 in x 3.25 in 100/pk



SCAF-STSI 1042
6.75 in x 3.25 in 100/pk



SCAF-STSI 539
6.75 in x 3.25 in 100/pk



SCAF-STSI 694
7.625 in x 3.25 in 100/pk



SCAF-STSI 681
7.625 in x 3.25 in 100/pk

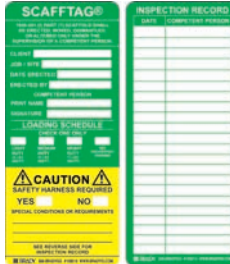

SCAF-STSI 311
7.625 in x 3.25 in 100/pk



SCAF-STSI 639
7.625 in x 3.25 in 100/pk



SCAF-STSI 310 STD
7.625 in x 3.25 in 100/pk



SCAF-STSI 602
6.75 in x 3.25 in 100/pk

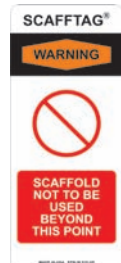

SCAF-STSIW 510
7.625 in x 3.25 in 100/pk



SCAF-STSIP 501
7.625 in x 3.25 in 100/pk



SCAF-STSI 629
7.625 in x 3.25 in 100/pk



SCAF-STSI 772
7.625 in x 3.25 in 100/pk

Facility Tags

Inspection Tags

BradyID.com/s36

Forklifttag® Holder and Inserts

- Assists with pre-use preventative maintenance and forklift safety inspections
- Permanently attaches to the cage of the forklift truck and displays the daily or pre-shift inspections be carried out



FLT-ETSI 519



FLT-ETSI 537



FLT-ETSI 51

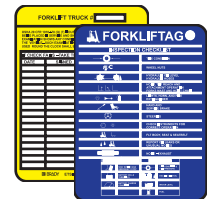

FLT-ETSI 583

Catalog #	Description	Size	Color	Qty.
FLT-ETSH9	Forklift Holder	11.5 in. x 6.000 in.	White	10/pk
FLT-ETSI 519	Inserts	5.75 in. x 7.625 in.	Green	100/pkg
FLT-ETSI 537	Inserts	5.75 in. x 7.625 in.	Green	100/pkg
FLT-ETSI 51	Inserts	5.75 in. x 7.625 in.	Blue	100/pkg
FLT-ETSI 583	Inserts	5.75 in. x 7.625 in.	Blue	100/pkg
FLT-ETSH9A	Forklift Kit*	11.5 in. x 6.000 in.		1 kit

*Kit includes 10 holders, 10 FLT-ETSI 51 inserts and 1 pen

LadderTags™ Holder and Inserts

- Supports a complete ladder safety management system
- Assists with meeting OSHA standards which require ladders to be checked for damage, faults and wear before use by an authorized user
- Holder can be attached by hanger holes or included adhesive

Catalog #	Description	Size	Color	Qty.
LAD-EITH12	Holders	8.25 in. x 2.25 in.	White	10/pk
LAD-EITL 500	Inserts	6.5 in x 2 in	Yellow	100/pkg
LAD-EITL 512	Inserts	6.5 in x 2 in	Green	100/pkg
LAD-EITL521	Inserts	6.5 in x 2 in	Yellow	100/pkg
LAD-EITH/L12	Kit*	8.25 in. x 2.25 in.	White	1 kit

*Kit includes 10 holders, 10 LAD-EITL 500 inserts and 1 pen



LAD-EITL 500



LAD-EITL 512



LAD-EITL521

Facility Tags

MultiTag® Holder and Inserts

- Assists with the identification and preventative maintenance requirements of a range of equipment
- Assists with the requirements of CFR 1926.1053 (a) (12), (b) (17) (i) (ii) and CFR 1910.25 (d) (1) (X).

Catalog #	Description	Size	Color	Qty.
MUL-EITHUSA01	MultiTag Holder	8.25 in x 2.25 in	White	10/pk
MUL-BLANK - FG	Blank Holder	8.25 in x 2.25 in	White	10/pk
MUL-EITL 540	MultiTag Inserts	6.5 in x 2 in	Yellow	100/pkg
MUL-EITL535	MultiTag Inserts	6.5 in x 2 in	Green	100/pkg
MUL-EITHUSA01A	MultiTag Kit	8.25 in x 2.25 in	White	1 kit

*Kit includes 10 holders, 10 MUL-EITL535 inserts and 1 pen



MUL-EITL 540



MUL-EITL535

EntryTag® Holder and Inserts

- Works in conjunction with existing permit-to-work systems and assists in meeting OSHA confined space standards
- The system states the minimum requirements of entry to the confined space or whether the area is in prohibition and cannot be entered



Catalog #	Description	Size	Qty.
ENT-ETSH157	Do Not Enter holder	11.25 in x 6 in	10/pk
ENT-ETSH 500	Confined Space holder	11.25 in x 6 in	10/pk
ENT-ETSH 505	Do Not Use Equipment holder	11.25 in x 6 in	10/pk
ENT-ETSH 506	Manlift holder	11.25 in x 6 in	10/pk
ENT-ETSH BLANK-FG	Blank holder	11.25 in x 6 in	10/pk
ENT-ETSH157A	Do Not Enter kit*	11.25 in x 6 in	1 kit

*Kit includes 10 holders, 10 status inserts and 1 pen.

<p>ENT-ETSI532 5.75 in x 7.625 in 100/pk</p>	<p>ENT-ETSI 549 5.75 in x 7.625 in 100/pk</p>	<p>ENT-ETSI 594 5.75 in x 7.625 in 100/pk</p>	<p>ENT-ETSI 567 5.75 in x 7.625 in 100/pk</p>	<p>MUL-EITL 230 2 in x 6.5 in 100/pk</p>
--	---	---	---	--

Confined Space Tags

- **Heavy-duty Laminated Polyester (LAM)** - Durable polyester laminate completely encapsulates and protects graphics while withstanding moisture, grease, chemicals and extreme temperatures. These tags exceed OSHA's 50-lb. pull force requirement for lockout tagout and include 3/8 in. heavy duty brass grommets. Nylon ties included.
- **Economy Polyester (POLY)** - Rigid polyester surface exceeds OSHA's 50-lb. pull force requirement for lockout tagout. Tags include 3/8 in. rolled brass eyelets. Nylon ties included.
- **Cardstock (CARD)** - Cardstock tags provide an economical, yet durable, material option. Attachment strings included.

<p>49234 5.75 in. x 3 in. LAM 25/pk</p>	<p>49228 5.75 in. x 3 in. POLY 25/pk</p>	<p>50275 5.75 in. x 3 in. LAM 25/pk</p>	<p>49227 5.75 in. x 3 in. POLY 25/pk</p>	<p>66322 5.75 in. x 3 in. LAM 25/pk</p>	<p>66324 5.75 in. x 3 in. POLY 25/pk</p>	<p>65457 5.75 in. x 3 in. CARD 25/pk</p>		
<p>50248 5.75 in. x 3 in. LAM 25/pk</p>	<p>50282 5.75 in. x 3 in. POLY 25/pk</p>	<p>50287 5.75 in. x 3 in. LAM 25/pk</p>	<p>50286 5.75 in. x 3 in. POLY 25/pk</p>	<p>50291 5.75 in. x 3 in. LAM 25/pk</p>	<p>50290 5.75 in. x 3 in. POLY 25/pk</p>	<p>65299 5.75 in. x 3 in. LAM 25/pk</p>	<p>65270 5.75 in. x 3 in. POLY 25/pk</p>	<p>65456 5.75 in. x 3 in. CARD 25/pk</p>

Facility Tags

Inspection Tags

BradyID.com/s36

ChemTag® Holder and Inserts

- Places first response information at the location where immediate access is needed.
- Identifies and controls hazardous substances and assists with the requirements of CFR 1910.1200 (A) (1)



Catalog #	Description	Size	Qty.
CHEM-CTHUSA01	Holder	11.25 in x 6 in	10/pk
CHEM-CTHBLANK-FG	Blank Holder	11.25 in x 6 in	10/pk
CHEM-CTI500	Insert	5.75 in x 7.625 in	100/pk
CHEM-CTSH	kit		1 kit

*Kit includes 10 holders, 10 CHEM-CTI500 inserts and 1 pen.

Cylinder Status Tags

- Clearly inform user of status of cylinder contents
- Economy Polyester (POLY) includes nylon fasteners
- Cardstock (CARD) includes string fasteners

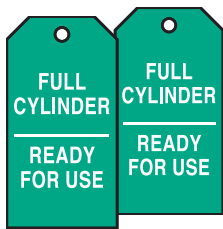

17926 5.75 in. x 3 in. POLY 10/pk
17925 5.75 in. x 3 in. CARD 100/pk



17928 5.75 in. x 3 in. POLY 10/pk
17927 5.75 in. x 3 in. CARD 100/pk



17924 5.75 in. x 3 in. POLY 10/pk
17923 5.75 in. x 3 in. CARD 100/pk



Facility Tags

Fire Extinguisher Inspection Tags

- Economy Polyester (POLY) meet OSHA's 50-lb. pull force requirement for tagout and have moderate chemical and UV resistance
- Tags meet OSHA Standard 1910.145 for accident prevention
- Withstands moisture, grease and dirt
- Nylon ties included

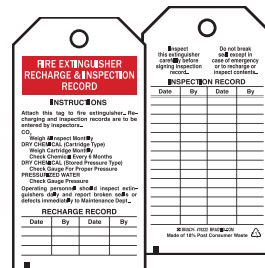

76222 5.75 x 3 in. POLY 25/pk

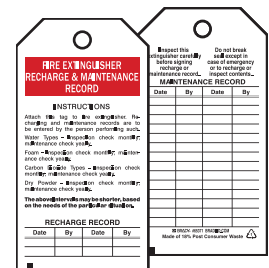

65371 5.75 x 3 in. POLY 25/pk

Aluminum Fire Extinguisher Inspection Tags

- Rigid aluminum won't rust, tear or fade when used in harsh outdoor applications
- Use permanent marking pen or hole punch to mark inspection
- Tags begin with current year
- Wire ties included

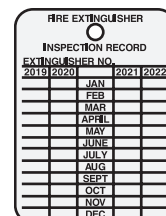

103632 3 x 2.25 in. ALUM 10/pk

Isolation Blind Tags

- Made from 10-mil polyester and has excellent outdoor weather resistance
- Tag includes 3/8 in. dia. hole with rolled brass eyelet and 25 nylon cable ties
- Exceeds OSHA 50-lb pull strength requirement for tagout



132421 5.75 in. x 3 in. CARD 25/pk



132422 5.75 in. x 3 in. CARD 25/pk



132424 5.75 in. x 3 in. CARD 25/pk



132423 5.75 in. x 3 in. CARD 25/pk



132425 5.75 in. x 3 in. CARD 25/pk

Flag Style Blind Tag

- Made from B-851 polyester (10-mil)
- 3/8 in. diameter hole with rolled brass eyelet
- Excellent outdoor weather resistance and is highly visual for safety warnings
- Exceeds OSHA 50-lb pull strength requirement
- Includes 25 nylon cable ties



Catalog #	Legend	Size	Color	Qty.
132452	Install Blind Here	2 in. x 20 in.	Black on Green	25
132453	Isolation Blind	2 in. x 20 in.	Black on Red	25
132454	Blind Installed	2 in. x 20 in.	Black on Red	25

Customize It

Call Brady Customer Service to customize with text, serialization, and perforation.

Isolation Tags

- To help control mechanical and electrical isolation procedures and prevent inadvertent energizing of the system
- Perforated tag consists of two identical sections which are completed by the person in charge



Catalog # 100-ISO 08 Color 7.625 in x 3.25 in Qty. 100/pk

Flange Joint Tags

- To assist in the inspection, modification and maintenance throughout the flange break inspection process
- Tag is divided into three parts by two perforations and assists the user to clearly identify the various stages of the operation from the initial break to the re-energization of the system



Catalog # 833763 Color 7.625 in x 3.25 in Qty. 10/pk



Catalog # 833764 Color 7.625 in x 3.25 in Qty. 10/pk

Inspection Tags

BradyID.com/s36

Inspection / Material Control Tags

- Tags meet OSHA Standard 1910.145 for accident prevention
- **Heavy-duty Laminated Polyester (LAM)** meet OSHA's 50 lb. pull force requirement for tagout and have superior chemical resistance. Plastic tags are encapsulated in matte polyester laminate for superior durability. Nylon ties included.
- **Economy Polyester (POLY)** meet OSHA's 50-lb. pull force requirement for tagout and have moderate chemical and UV resistance. Nylon ties included.
- **Cardstock (CARD)** provide an economical, yet durable, material option. Attachment strings included.

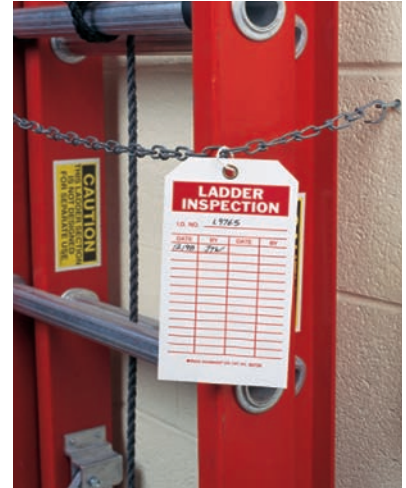

86435 5.75 x 3 in. LAM 10/pk
86497 7 x 4 in. LAM 10/pk
86562 5.75 x 3 in. POLY 10/pk
86617 7 x 4 in. POLY 10/pk
86672 5.75 x 3 in. CARD 100/pk
86727 7 x 4 in. CARD 100/pk

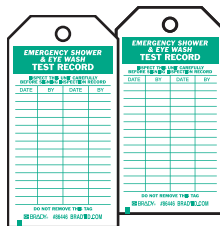

86446 5.75 x 3 in. LAM 10/pk
86508 7 x 4 in. LAM 10/pk
86560 5.75 x 3 in. POLY 10/pk
86615 7 x 4 in. POLY 10/pk
86670 5.75 x 3 in. CARD 100/pk
86725 7 x 4 in. CARD 100/pk

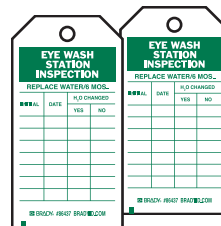

86437 5.75 x 3 in. LAM 10/pk
86499 7 x 4 in. LAM 10/pk
86564 5.75 x 3 in. POLY 10/pk
86619 7 x 4 in. POLY 10/pk
86674 5.75 x 3 in. CARD 100/pk
86729 7 x 4 in. CARD 100/pk

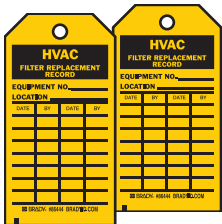

86444 5.75 x 3 in. LAM 10/pk
86506 7 x 4 in. LAM 10/pk
86558 5.75 x 3 in. POLY 10/pk
86613 7 x 4 in. POLY 10/pk
86668 5.75 x 3 in. CARD 100/pk
86723 7 x 4 in. CARD 100/pk



86438 5.75 x 3 in. LAM 10/pk
86500 7 x 4 in. LAM 10/pk
86565 5.75 x 3 in. POLY 10/pk
86620 7 x 4 in. POLY 10/pk
86675 5.75 x 3 in. CARD 100/pk
86730 7 x 4 in. CARD 100/pk

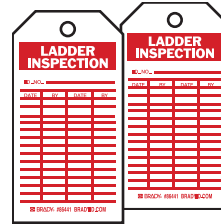

86441 5.75 x 3 in. LAM 10/pk
86503 7 x 4 in. LAM 10/pk
86555 5.75 x 3 in. POLY 10/pk
86610 7 x 4 in. POLY 10/pk
86665 5.75 x 3 in. CARD 100/pk
86720 7 x 4 in. CARD 100/pk



86447 5.75 x 3 in. LAM 10/pk
86509 7 x 4 in. LAM 10/pk
86561 5.75 x 3 in. POLY 10/pk
86616 7 x 4 in. POLY 10/pk
86671 5.75 x 3 in. CARD 100/pk
86726 7 x 4 in. CARD 100/pk



86445 5.75 x 3 in. LAM 10/pk
86559 5.75 x 3 in. POLY 10/pk
86614 7 x 4 in. POLY 10/pk
86669 5.75 x 3 in. CARD 100/pk
86724 7 x 4 in. CARD 100/pk



86449 5.75 x 3 in. LAM 10/pk
86511 7 x 4 in. LAM 10/pk
86569 5.75 x 3 in. POLY 10/pk
86624 7 x 4 in. POLY 10/pk
86679 5.75 x 3 in. CARD 100/pk
86734 7 x 4 in. CARD 100/pk



86442 5.75 x 3 in. LAM 10/pk
86504 7 x 4 in. LAM 10/pk
86556 5.75 x 3 in. POLY 10/pk
86611 7 x 4 in. POLY 10/pk
86666 5.75 x 3 in. CARD 100/pk
86721 7 x 4 in. CARD 100/pk



86443 5.75 x 3 in. LAM 10/pk
86505 7 x 4 in. LAM 10/pk
86557 5.75 x 3 in. POLY 10/pk
86612 7 x 4 in. POLY 10/pk
86667 5.75 x 3 in. CARD 100/pk
86722 7 x 4 in. CARD 100/pk



86439 5.75 x 3 in. LAM 10/pk
86501 7 x 4 in. LAM 10/pk
86566 5.75 x 3 in. POLY 10/pk
86621 7 x 4 in. POLY 10/pk
86676 5.75 x 3 in. CARD 100/pk
86731 7 x 4 in. CARD 100/pk



86450 5.75 x 3 in. LAM 10/pk
86512 7 x 4 in. LAM 10/pk
86570 5.75 x 3 in. POLY 10/pk
86625 7 x 4 in. POLY 10/pk
86680 5.75 x 3 in. CARD 100/pk
86735 7 x 4 in. CARD 100/pk

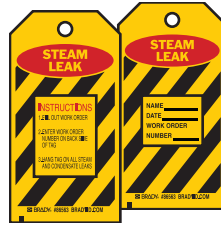

86436 5.75 x 3 in. LAM 10/pk
86498 7 x 4 in. LAM 10/pk
86563 5.75 x 3 in. POLY 10/pk
86673 5.75 x 3 in. CARD 100/pk
86728 7 x 4 in. CARD 100/pk

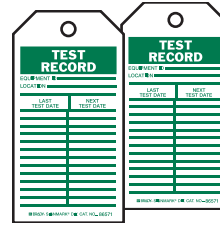

86451 5.75 x 3 in. LAM 10/pk
86513 7 x 4 in. LAM 10/pk
86571 5.75 x 3 in. POLY 10/pk
86626 7 x 4 in. POLY 10/pk
86681 5.75 x 3 in. CARD 100/pk
86736 7 x 4 in. CARD 100/pk



86448 5.75 x 3 in. LAM 10/pk
86510 7 x 4 in. LAM 10/pk
86568 5.75 x 3 in. POLY 10/pk
86623 7 x 4 in. POLY 10/pk
86678 5.75 x 3 in. CARD 100/pk
86733 7 x 4 in. CARD 100/pk

Facility Tags

Production Status Tags

- Designed to help you monitor and control production and equipment maintenance
- Cardstock tags include 0.375 in. metal grommet and attachment strings
- Backs of tags are blank



 86775 3 in. x 5.75 in. 100/pk	 86774 3 in. x 5.75 in. 100/pk				
 86743 3 in. x 5.75 in. 100/pk	 86750 3 in. x 5.75 in. 100/pk	 86753 3 in. x 5.75 in. 100/pk	 86754 3 in. x 5.75 in. 100/pk	 86756 3 in. x 5.75 in. 100/pk	
 86763 3 in. x 5.75 in. 100/pk	 86762 3 in. x 5.75 in. 100/pk	 86746 3 in. x 5.75 in. 100/pk	 86747 3 in. x 5.75 in. 100/pk	 86752 3 in. x 5.75 in. 100/pk	
 86748 3 in. x 5.75 in. 100/pk	 86749 3 in. x 5.75 in. 100/pk	 86740 3 in. x 5.75 in. 100/pk	 86772 3 in. x 5.75 in. 100/pk	 86768 3 in. x 5.75 in. 100/pk	
 86779 3 in. x 5.75 in. 100/pk	 86773 3 in. x 5.75 in. 100/pk	 86761 3 in. x 5.75 in. 100/pk	 86760 3 in. x 5.75 in. 100/pk	 86751 3 in. x 5.75 in. 100/pk	
 86757 3 in. x 5.75 in. 100/pk	 86769 3 in. x 5.75 in. 100/pk	 86771 3 in. x 5.75 in. 100/pk	 86744 3 in. x 5.75 in. 100/pk	 86745 3 in. x 5.75 in. 100/pk	
 86780 3 in. x 5.75 in. 100/pk	 86781 3 in. x 5.75 in. 100/pk	 86755 3 in. x 5.75 in. 100/pk	 86776 3 in. x 5.75 in. 100/pk	 86777 3 in. x 5.75 in. 100/pk	
 86778 3 in. x 5.75 in. 100/pk	 86767 3 in. x 5.75 in. 100/pk	 86765 3 in. x 5.75 in. 100/pk	 86764 3 in. x 5.75 in. 100/pk	 86766 3 in. x 5.75 in. 100/pk	
 86759 3" x 5.75" 100/pk	 86758 3" x 5.75" 100/pk	 86741 3" x 5.75" 100/pk	 86770 3" x 5.75" 100/pk	 86742 3" x 5.75" 100/pk	

Facility Tags

Facility Tags

BradyID.com/s36

Accident Prevention Tags

- **Heavy-duty Laminated Polyester (LAM)** - Durable polyester laminate completely encapsulates and protects graphics while withstanding moisture, grease, chemicals and extreme temperatures. These tags exceed OSHA's 50-lb. pull force requirement for Lockout Tagout and include 3/8 in. heavy duty brass grommets. Nylon ties included.
- **Economy Polyester (POLY)** - Rigid polyester surface exceeds OSHA's 50-lb. pull force requirement for Lockout Tagout. Provides good outdoor UV resistance. Tags include 3/8 in. rolled brass eyelets. Nylon ties included.
- **Cardstock (CARD)** - Cardstock tags provide an economical, yet durable, material option. Attachment strings included.

* Tags have a self-adhesive, clear overlaminate flap which is pressed over the face of the tag for permanent protection.

† Tags have a larger hole without a grommet to accommodate padlocks.

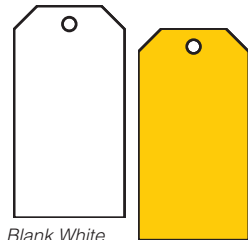

Blank White

65372	3 x 5.75 in.	POLY	25/pk
76198	3 x 5.75 in.	POLY*	25/pk
65349	3 x 5.75 in.	POLY†	25/pk

Blank Yellow

65373	3 x 5.75 in.	POLY	25/pk
76197	3 x 5.75 in.	POLY*	25/pk
65350	3 x 5.75 in.	POLY†	25/pk



76168	3 x 5.75 in.	POLY	25/pk
76193	3 x 5.75 in.	POLY*	25/pk
65348	3 x 5.75 in.	POLY†	25/pk



86433	5.75 x 3 in.	LAM	10/pk
86494	7 x 4 in.	LAM	10/pk
86552	5.75 x 3 in.	POLY	10/pk
86607	7 x 4 in.	POLY	10/pk
86662	5.75 x 3 in.	CARD	100/pk
86717	7 x 4 in.	CARD	100/pk



86427	5.75 x 3 in.	LAM	10/pk
86546	5.75 x 3 in.	POLY	10/pk
86601	7 x 4 in.	POLY	10/pk
86656	5.75 x 3 in.	CARD	100/pk
86711	7 x 4 in.	CARD	100/pk



86426	5.75 x 3 in.	LAM	10/pk
86487	7 x 4 in.	LAM	10/pk
86545	5.75 x 3 in.	POLY	10/pk
86600	7 x 4 in.	POLY	10/pk
86655	5.75 x 3 in.	CARD	100/pk
86710	7 x 4 in.	CARD	100/pk



86428	5.75 x 3 in.	LAM	10/pk
86547	5.75 x 3 in.	POLY	10/pk
86602	7 x 4 in.	POLY	10/pk
86657	5.75 x 3 in.	CARD	100/pk
86712	7 x 4 in.	CARD	100/pk



86425	5.75 x 3 in.	LAM	10/pk
86486	7 x 4 in.	LAM	10/pk
86544	5.75 x 3 in.	POLY	10/pk
86599	7 x 4 in.	POLY	10/pk
86654	5.75 x 3 in.	CARD	100/pk
86709	7 x 4 in.	CARD	100/pk



86424	5.75 x 3 in.	LAM	10/pk
86485	7 x 4 in.	LAM	10/pk
86543	5.75 x 3 in.	POLY	10/pk
86598	7 x 4 in.	POLY	10/pk
86653	5.75 x 3 in.	CARD	100/pk
86708	7 x 4 in.	CARD	100/pk



86430	5.75 x 3 in.	LAM	10/pk
86549	5.75 x 3 in.	POLY	10/pk
86604	7 x 4 in.	POLY	10/pk
86659	5.75 x 3 in.	CARD	100/pk
86714	7 x 4 in.	CARD	100/pk



76171	3 x 5.75 in.	POLY	25/pk
76192	3 x 5.75 in.	POLY*	25/pk
65347	3 x 5.75 in.	POLY†	25/pk



86420	5.75 x 3 in.	LAM	10/pk
86481	7 x 4 in.	LAM	10/pk
86539	5.75 x 3 in.	POLY	10/pk
86594	7 x 4 in.	POLY	10/pk
86649	5.75 x 3 in.	CARD	100/pk
86704	7 x 4 in.	CARD	100/pk



86421	5.75 x 3 in.	LAM	10/pk
86482	7 x 4 in.	LAM	10/pk
86540	5.75 x 3 in.	POLY	10/pk
86595	7 x 4 in.	POLY	10/pk
86650	5.75 x 3 in.	CARD	100/pk
86705	7 x 4 in.	CARD	100/pk



86431	5.75 x 3 in.	LAM	10/pk
86492	7 x 4 in.	LAM	10/pk
86550	5.75 x 3 in.	POLY	10/pk
86605	7 x 4 in.	POLY	10/pk
86660	5.75 x 3 in.	CARD	100/pk
86715	7 x 4 in.	CARD	100/pk



86409	5.75 x 3 in.	LAM	10/pk
86470	7 x 4 in.	LAM	10/pk
86528	5.75 x 3 in.	POLY	10/pk
86583	7 x 4 in.	POLY	10/pk
86638	5.75 x 3 in.	CARD	100/pk
86693	7 x 4 in.	CARD	100/pk



86414	5.75 x 3 in.	LAM	10/pk
86475	7 x 4 in.	LAM	10/pk
86533	5.75 x 3 in.	POLY	10/pk
86588	7 x 4 in.	POLY	10/pk
86643	5.75 x 3 in.	CARD	100/pk
86698	7 x 4 in.	CARD	100/pk

Additional Bilingual Tags Available

Contact Brady Customer Service to order or visit BradyID.com



86465	7 x 4 in.	LAM	10/pk
86523	5.75 x 3 in.	POLY	10/pk
86578	7 x 4 in.	POLY	10/pk
86633	5.75 x 3 in.	CARD	100/pk
86688	7 x 4 in.	CARD	100/pk



86407	5.75 x 3 in.	LAM	10/pk
86468	7 x 4 in.	LAM	10/pk
86526	5.75 x 3 in.	POLY	10/pk
86581	7 x 4 in.	POLY	10/pk
86636	5.75 x 3 in.	CARD	100/pk
86691	7 x 4 in.	CARD	100/pk



86406	5.75 x 3 in.	LAM	10/pk
86467	7 x 4 in.	LAM	10/pk
86525	5.75 x 3 in.	POLY	10/pk
86580	7 x 4 in.	POLY	10/pk
86635	5.75 x 3 in.	CARD	100/pk
86690	7 x 4 in.	CARD	100/pk



86405	5.75 x 3 in.	LAM	10/pk
86524	5.75 x 3 in.	POLY	10/pk
86579	7 x 4 in.	POLY	10/pk
86634	5.75 x 3 in.	CARD	100/pk
86689	7 x 4 in.	CARD	100/pk



86403	5.75 x 3 in.	LAM	10/pk
86464	7 x 4 in.	LAM	10/pk
86522	5.75 x 3 in.	POLY	10/pk
86577	7 x 4 in.	POLY	10/pk
86632	5.75 x 3 in.	CARD	100/pk
86687	7 x 4 in.	CARD	100/pk



86411	5.75 x 3 in.	LAM	10/pk
86472	7 x 4 in.	LAM	10/pk
86530	5.75 x 3 in.	POLY	10/pk
86585	7 x 4 in.	POLY	10/pk
86640	5.75 x 3 in.	CARD	100/pk
86695	7 x 4 in.	CARD	100/pk



86422	5.75 x 3 in.	LAM	10/pk
86483	7 x 4 in.	LAM	10/pk
86541	5.75 x 3 in.	POLY	10/pk
86596	7 x 4 in.	POLY	10/pk
86651	5.75 x 3 in.	CARD	100/pk
86706	7 x 4 in.	CARD	100/pk

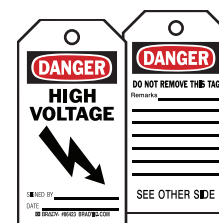

86423	5.75 x 3 in.	LAM	10/pk
86484	7 x 4 in.	LAM	10/pk
86542	5.75 x 3 in.	POLY	10/pk
86597	7 x 4 in.	POLY	10/pk
86652	5.75 x 3 in.	CARD	100/pk
86707	7 x 4 in.	CARD	100/pk



86415	5.75 x 3 in.	LAM	10/pk
86476	7 x 4 in.	LAM	10/pk
86534	5.75 x 3 in.	POLY	10/pk
86589	7 x 4 in.	POLY	10/pk
86644	5.75 x 3 in.	CARD	100/pk
86699	7 x 4 in.	CARD	100/pk



86429	5.75 x 3 in.	LAM	10/pk
86490	7 x 4 in.	LAM	10/pk
86548	5.75 x 3 in.	POLY	10/pk
86603	7 x 4 in.	POLY	10/pk
86658	5.75 x 3 in.	CARD	100/pk
86713	7 x 4 in.	CARD	100/pk



86408	5.75 x 3 in.	LAM	10/pk
86469	7 x 4 in.	LAM	10/pk
86527	5.75 x 3 in.	POLY	10/pk
86582	7 x 4 in.	POLY	10/pk
86637	5.75 x 3 in.	CARD	100/pk
86692	7 x 4 in.	CARD	100/pk



86410	5.75 x 3 in.	LAM	10/pk
86471	7 x 4 in.	LAM	10/pk
86529	5.75 x 3 in.	POLY	10/pk
86584	7 x 4 in.	POLY	10/pk
86639	5.75 x 3 in.	CARD	100/pk
86694	7 x 4 in.	CARD	100/pk



86432	5.75 x 3 in.	LAM	10/pk
86493	7 x 4 in.	LAM	10/pk
86551	5.75 x 3 in.	POLY	10/pk
86606	7 x 4 in.	POLY	10/pk
86661	5.75 x 3 in.	CARD	100/pk
86716	7 x 4 in.	CARD	100/pk



86416	5.75 x 3 in.	LAM	10/pk
86535	5.75 x 3 in.	POLY	10/pk
86590	7 x 4 in.	POLY	10/pk
86645	5.75 x 3 in.	CARD	100/pk
86700	7 x 4 in.	CARD	100/pk



86413	5.75 x 3 in.	LAM	10/pk
86474	7 x 4 in.	LAM	10/pk
86532	5.75 x 3 in.	POLY	10/pk
86587	7 x 4 in.	POLY	10/pk
86642	5.75 x 3 in.	CARD	100/pk
86697	7 x 4 in.	CARD	100/pk



86417	5.75 x 3 in.	LAM	10/pk
86478	7 x 4 in.	LAM	10/pk
86536	5.75 x 3 in.	POLY	10/pk
86591	7 x 4 in.	POLY	10/pk
86646	5.75 x 3 in.	CARD	100/pk
86701	7 x 4 in.	CARD	100/pk



86553	5.75 x 3 in.	POLY	10/pk
86608	7 x 4 in.	POLY	10/pk
86663	5.75 x 3 in.	CARD	100/pk
86718	7 x 4 in.	CARD	100/pk



86434	5.75 x 3 in.	LAM	10/pk
86496	7 x 4 in.	LAM	10/pk
86554	5.75 x 3 in.	POLY	10/pk
86609	7 x 4 in.	POLY	10/pk
86664	5.75 x 3 in.	CARD	100/pk
86719	7 x 4 in.	CARD	100/pk



86418	5.75 x 3 in.	LAM	10/pk
86537	5.75 x 3 in.	POLY	10/pk
86592	7 x 4 in.	POLY	10/pk
86647	5.75 x 3 in.	CARD	100/pk
86702	7 x 4 in.	CARD	100/pk

Lockout Tags

BradyID.com/s36

new

RipTag™ Safety Tag Rolls

- Complete and convenient take-it-with-you system for tagging
- Includes a bulk roll of tags that easily tear off and cable ties for quick attachment
- B-851 polyester tags comply with OSHA's 50-lb. pull force regulation for lockout tagout



ToughWash® Metal-Detectable Tags

- ToughWash B-869 polypropylene tags feature in-molded, protected graphics for use in harsh washdown environments
- With metal and X-ray detectable properties, these tags won't compromise your food safety
- Durable plastic-encapsulated material withstands harsh washdown environments with temperatures up to 175°F (80°C) and pressure up to 1,500 PSI
- Includes 10 metal-detectable cable ties

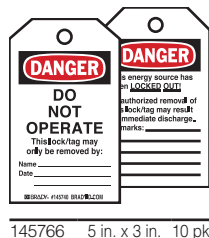

Extra Metal-Detectable Ties		
145588	7 in. ToughWash Ties	10 pk
145589	7 in. ToughWash Ties	100 pk

Facility Tags

Additional Lockout Tags on page 202.

Communicate safety and lockout information at the point of need with Brady's wide selection of OSHA-compliant Lockout Tagout tags.







Energy Source Tags





Energy source tags can be used to mark your facility's points of control for energy sources. These tags help make the lockout process quicker, safer and easier.

These energy source tags are made of plastic and are available with color coded and alpha numeric options. A variety of pre-printed energy source tags are available or they can be customized to meet your specific application.

- 1.5 in. x 3 in. tags are constructed with B-401 Rigid Plastic
- Rounded corners and one hole included
- Choice of number legends supports machines with multiple energy points.



	Catalog #	Legend	Color	Qty.
Control Panel				
 <p>Control Panel tags supplied with an adhesive back.</p>	105634	CP-1	Orange on White	5
	105674	CP-1	Orange on White	25
	105635	CP-2	Orange on White	5
	105675	CP-2	Orange on White	25
	105636	CP-3	Orange on White	5
	105676	CP-3	Orange on White	25
	105637	CP-4	Orange on White	5
	105677	CP-4	Orange on White	25
	105638	CP-5	Orange on White	5
	105673	CP-5	Orange on White	25
Electrical				
 <p>Electrical tags supplied with an adhesive back.</p>	105639	E-1	Red on White	5
	105679	E-1	Red on White	25
	105640	E-2	Red on White	5
	105680	E-2	Red on White	25
	105641	E-3	Red on White	5
	105681	E-3	Red on White	25
	105642	E-4	Red on White	5
	105682	E-4	Red on White	25
	105643	E-5	Red on White	5
	105683	E-5	Red on White	25
Gas				
	105669	G-1	Purple on White	5
	105709	G-1	Purple on White	25
	105670	G-2	Purple on White	5
	105710	G-2	Purple on White	25
	105671	G-3	Purple on White	5
	105711	G-3	Purple on White	25
	105672	G-4	Purple on White	5
	105712	G-4	Purple on White	25
	105673	G-5	Purple on White	5
	105713	G-5	Purple on White	25
Pneumatic / Air				
	105654	P-1	White on Blue	5
	105694	P-1	White on Blue	25
	105655	P-2	White on Blue	5
	105695	P-2	White on Blue	25
	105656	P-3	White on Blue	5
	105696	P-3	White on Blue	25
	105657	P-4	White on Blue	5
	105697	P-4	White on Blue	25
	105658	P-5	White on Blue	5
	105698	P-5	White on Blue	25

	Catalog #	Legend	Color	Qty.
Steam Red				
	105649	S-1	White on Red	5
	105689	S-1	White on Red	25
	105650	S-2	White on Red	5
	105690	S-2	White on Red	25
	105651	S-3	White on Red	5
	105691	S-3	White on Red	25
	105652	S-4	White on Red	5
	105692	S-4	White on Red	25
	105653	S-5	White on Red	5
	105693	S-5	White on Red	25
Steam Orange				
	105659	S-1	Black on Orange	5
	105699	S-1	Black on Orange	25
	105660	S-2	Black on Orange	5
	105700	S-2	Black on Orange	25
	105661	S-3	Black on Orange	5
	105701	S-3	Black on Orange	25
	105662	S-4	Black on Orange	5
	105702	S-4	Black on Orange	25
	105663	S-5	Black on Orange	5
	105703	S-5	Black on Orange	25
Valve				
	105664	V-1	Black on White	5
	105704	V-1	Black on White	25
	105665	V-2	Black on White	5
	105705	V-2	Black on White	25
	105666	V-3	Black on White	5
	105706	V-3	Black on White	25
	105667	V-4	Black on White	5
	105707	V-4	Black on White	25
	105668	V-5	Black on White	5
	105708	V-5	Black on White	25
Water				
	105644	W-1	White on Green	5
	105684	W-1	White on Green	25
	105645	W-2	White on Green	5
	105685	W-2	White on Green	25
	105646	W-3	White on Green	5
	105686	W-3	White on Green	25
	105647	W-4	White on Green	5
	105687	W-4	White on Green	25
	105648	W-5	White on Green	5
	105688	W-5	White on Green	25

Facility Tags

Red Tag Program

BradyID.com/s36

Red Tag Program

- Brady Red Tag products are ideal to visually and effectively manage your red tag program
- Conforms with ANSI Z535 standards
- Signs are available in three materials:
B-140 polyester on fiberglass (FB)
B-302 self-sticking polyester (SS)
B-401 plastic (PL)



122274	10 in. x 7 in.	FB
122298	14 in. x 10 in.	FB
122275	10 in. x 7 in.	SS
122299	14 in. x 10 in.	SS
122273	10 in. x 7 in.	PL
122297	14 in. x 10 in.	PL

122268	10 in. x 7 in.	FB
122292	14 in. x 10 in.	FB
122269	10 in. x 7 in.	SS
122293	14 in. x 10 in.	SS
122267	10 in. x 7 in.	PL
122291	14 in. x 10 in.	PL

122271	10 in. x 7 in.	FB
122295	14 in. x 10 in.	FB
122272	10 in. x 7 in.	SS
122296	14 in. x 10 in.	SS
122270	10 in. x 7 in.	PL
122294	14 in. x 10 in.	PL



49054 14 in. x 10 in. PL



122277	10 in. x 7 in.	FB
122301	14 in. x 10 in.	FB
122278	10 in. x 7 in.	SS
122302	14 in. x 10 in.	SS
122276	10 in. x 7 in.	PL
122300	14 in. x 10 in.	PL



122289	10 in. x 7 in.	FB
122313	14 in. x 10 in.	FB
122290	10 in. x 7 in.	SS
122314	14 in. x 10 in.	SS
122288	10 in. x 7 in.	PL
122312	14 in. x 10 in.	PL



122286	10 in. x 7 in.	FB
122310	14 in. x 10 in.	FB
122287	10 in. x 7 in.	SS
122311	14 in. x 10 in.	SS
122285	10 in. x 7 in.	PL
122309	14 in. x 10 in.	PL



122280	10 in. x 7 in.	FB
122304	14 in. x 10 in.	FB
122281	10 in. x 7 in.	SS
122305	14 in. x 10 in.	SS
122279	10 in. x 7 in.	PL
122303	14 in. x 10 in.	PL



122283	10 in. x 7 in.	FB
122307	14 in. x 10 in.	FB
122284	10 in. x 7 in.	SS
122308	14 in. x 10 in.	SS
122282	10 in. x 7 in.	PL
122306	14 in. x 10 in.	PL



Brief Red Tag

121521 5.75 in. x 3 in. Cardstock 100/pk

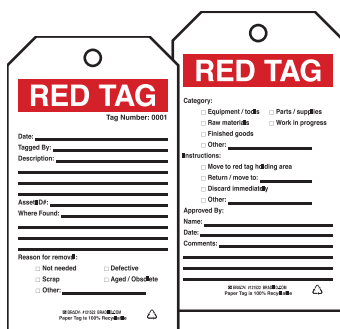

Detailed Red Tag

121522 7 in. x 4 in. Cardstock 100/pk

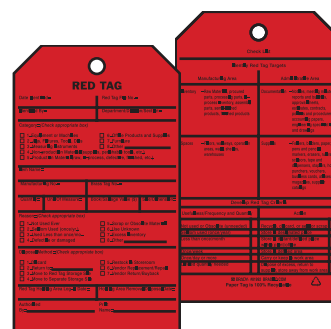

Discard Red Tag

81992 7 in. x 4 in. Cardstock 10/pk

Facility Tags



Red Tag Binder Station

- Polycarbonate backboard with wire rack for storing your Red Tag Binder
- Binder: 10 in. W x 11 in. H x 2 in. D
Rack: 14 in. W x 9 in. H

Catalog #	Description	Board Size	Qty.
122053	Station w/ binder	14 in. x 20 in.	1
122051	Station only	14 in. x 20 in.	1
122052	Binder only	10 in. x 11 in. x 2 in.	1



Red Tag Station

- Acrylic board with 2 tag pockets and 100 tags
- Choose from Brief Red Tags or Detailed Red Tags

Catalog #	Description	Board Size	Qty.
41F346	Station w/ Brief Red Tags	16 in. x 12 in.	1
41F347	Station w/ Detailed Tags	16 in. x 12 in.	1
41F340	Station only	16 in. x 12 in.	1



Red Tag Station w/ Clipboard

- Acrylic board with 2 tag pockets and 100 tags
- Choose from Brief Red Tags or Detailed Red Tags

Catalog #	Description	Size	Qty.
122056	Station w/ Brief Red Tags	22 in. x 16 in.	1
122057	Station w/ Detailed Tags	22 in. x 16 in.	1
122049	Station without tags	22 in. x 16 in.	1
122050	Clipboard Only	9.5 in. x 14 in.	1

Self-Laminating Tags

- Personalize tag by writing on special instructions, hazards or warnings, then apply clear self-laminating overlay to protect and seal your message
- Constructed of B-851 Economy Polyester with a 1-mil polyester overlay
- Exceeds OSHA's 50-lb. pull force requirement for tagout and has moderate chemical resistance
- Includes nylon ties

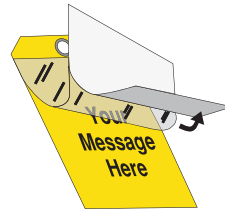

86455 5.75 in. x 3 in. 10/pk
81991 7 in. x 4 in. 10/pk



86460 5.75 in. x 3 in. 10/pk
86518 7 in. x 4 in. 10/pk



86458 5.75 in. x 3 in. 10/pk
86516 7 in. x 4 in. 10/pk



65501 5.75 in. x 3 in. 10/pk
96222 7 in. x 4 in. 10/pk



86461 5.75 in. x 3 in. 10/pk
86519 7 in. x 4 in. 10/pk



86459 5.75 in. x 3 in. 10/pk
86517 7 in. x 4 in. 10/pk



86456 5.75 in. x 3 in. 10/pk
86514 7 in. x 4 in. 10/pk



86457 5.75 in. x 3 in. 10/pk
86515 7 in. x 4 in. 10/pk

Blank Self-Laminating Tags

- Flexible and versatile tags perform multiple roles in URD and cable marking
- 10-mil polyester tags flex and conform easily to cables of any size
- Clear, self-laminating overlay protects written information
- Standard package: 25 tags and cable ties



Tags are full color underneath self-laminating liner.



Size	Colors					
	White	Yellow	Blue	Green	Orange	Red
2 in. x 3 in.	101991	101992	101995	101994	101996	101993
2.5 in. x 4 in.	102015	-	-	-	-	-
3 in. x 1.5 in.	101973	101974	101977	101976	101978	101975
3 in. x 3 in.	102003	102004	102007	102006	102008	102005
4 in. x 2 in.	101997	101998	102001	102000	102002	101999
5 in. x 1.5 in.	101979	101980	101983	101982	-	101981
5 in. x 2.5 in.	102016	102017	102020	102019	102021	102018
5 in. x 3.25 in.	102009	102010	102013	102012	102014	102011

Blank Tags

BradyID.com/s36

Blank Paper Tags

- Blank paper tags are an economical and convenient way to label equipment
- Standard package: 1,000 tags and attachment strings



Size	Standard Colors										Fluorescent Colors				
	White	Yellow	Pink	Orange	Green	Dark Green	Blue	Dark Blue	Lavender	Gray	Fluorescent Green	Fluorescent Red	Fluorescent Orange	Fluorescent Yellow	Fluorescent Pink
2.75 x 1.375 in.	102160	102136	102120	102128	-	102144	102088	102096	102152	102104	102064	102080	102048	102072	102056
3.25 x 1.625 in.	102161	102137	102121	102129	102113	102145	102089	102097	102153	102105	-	102081	102049	102073	102057
3.75 x 1.875 in.	102162	102138	102122	102130	102114	102146	102090	102098	102154	102106	102066	102082	102050	102074	102058
4.25 x 2.125 in.	102163	102139	102123	102131	102115	102147	102091	102099	102155	102107	102067	102083	102051	102075	102059
4.75 x 2.375 in.	102164	102140	102124	102132	102116	102148	102092	102100	-	102108	102068	102084	102052	102076	102060
5.25 x 2.625 in.	102165	102141	102125	102133	102117	102149	102093	102101	102157	102109	102069	102085	102053	102077	102061
5.75 x 2.875 in.	102166	102142	102126	102134	102118	102150	102094	102102	102158	102110	102070	102086	102054	102078	102062
6.25 x 3.125 in.	102167	102143	102127	102135	102119	102151	102095	102103	102159	102111	102071	102087	102055	102079	102063

Blank Manila Tags

- Blank paper tags are an economical and convenient way to label equipment



Catalog #	Size	Color	Qty.
102040	2.75 in. x 1.375 in.	Manila	1,000
102041	3.25 in. x 1.625 in.	Manila	1,000
102042	3.75 in. x 1.875 in.	Manila	1,000
102043	4.25 in. x 2.125 in.	Manila	1,000
102044	4.75 in. x 2.375 in.	Manila	1,000
102045	5.25 in. x 2.625 in.	Manila	1,000
102046	5.75 in. x 2.875 in.	Manila	1,000
102047	6.25 in. x 3.125 in.	Manila	1,000

Blank Tyvek Tags

- Weatherproof, tearproof and lightweight
- Includes metal eyelets



Catalog #	Size	Color	Qty.
102032	2.75 in. x 1.375 in.	White	1,000
102033	3.25 in. x 1.625 in.	White	1,000
102034	3.75 in. x 1.875 in.	White	1,000
102035	4.25 in. x 2.125 in.	White	1,000
102036	4.75 in. x 2.375 in.	White	1,000
102037	5.25 in. x 2.625 in.	White	1,000
102038	5.75 in. x 2.875 in.	White	1,000
102039	6.25 in. x 3.125 in.	White	1,000

Aluminum Write-On Tags

- Laminated B-184 Dead Soft Aluminum Foil on cardboard backing (includes plastic lock-on ties)
- For indoor use only



Catalog #	Description	Qty.
23199	1.125 in. x 3.5 in. Aluminum Foil Tag	25/pk

Facility Tags

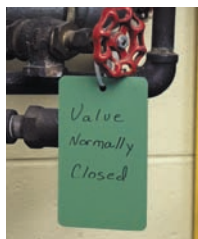

Metal Write-On Tags

- Durable metal accepts most marking pens and includes nylon tie
- Metal can be bent and straightened

Catalog #	Size	Color	Qty.
56937	5 in. x 3 in.	White	1 ea.
56936	5 in. x 3 in.	Yellow	1 ea.
56938	5 in. x 3 in.	Blue	1 ea.
56939	5 in. x 3 in.	Green	1 ea.
56940	5 in. x 3 in.	Red	1 ea.



Color-Coded Lock-On Tags

- Plastic tag locks onto itself
- Resists moisture, grease and dirt

Catalog #	Size	Color	Qty.
30680	5.8 in. x 3.25 in.	White	25/pk
30684	5.8 in. x 3.25 in.	Yellow	25/pk
30682	5.8 in. x 3.25 in.	Blue	25/pk
30683	5.8 in. x 3.25 in.	Green	25/pk
30681	5.8 in. x 3.25 in.	Red	25/pk

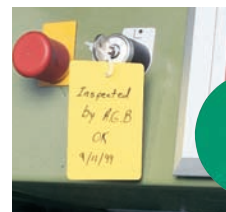

Color-Coded Plasti-Tags

- Rigid 10-mil blank tags with nylon ties
- Available in square or round shapes

Catalog #	Size	Color	Qty.
56927	2.5 in. x 3.5 in.	White	25/pk
56926	2.5 in. x 3.5 in.	Yellow	25/pk
56928	2.5 in. x 3.5 in.	Blue	25/pk
56929	2.5 in. x 3.5 in.	Green	25/pk
56930	2.5 in. x 3.5 in.	Red	25/pk
56932	3 in. Round	White	25/pk
56931	3 in. Round	Yellow	25/pk
56933	3 in. Round	Blue	25/pk
56934	3 in. Round	Green	25/pk
56935	3 in. Round	Red	25/pk



1-Pocket Tag Holder

- Clear plastic holder is designed to hold 50 tags, ties and a marking pen
- Comes with adhesive strips, magnetic strips and screws for mounting
- Dimensions: 7.5 in. x 4.5 in. x 1.5 in.
- Tags sold separately

Catalog #	Description
TH2	1-Pocket Economy Tag Holder



Pocket Premium Tag Center

- Acrylic center features 8 pockets for displaying and dispensing tags
- Each pocket holds up to 30 tags
- Four pre-drilled holes for wall mounting
- Board: 15.75 in. x 23.5 in. x 2 in.
- Pockets: 4.5 in. x 3.5 in.
- Tags sold separately

Catalog #	Description
TC8	8-Pocket Premium Tag Center



10-Pocket Tag Safety Station

- Made of rugged polycarbonate
- Four pre-drilled holes for wall mounting
- Dimensions: 22 in. x 16.5 in. x 2.25 in.
- Tags sold separately

Catalog #	Description
81773	10-Pocket Tag Safety Station

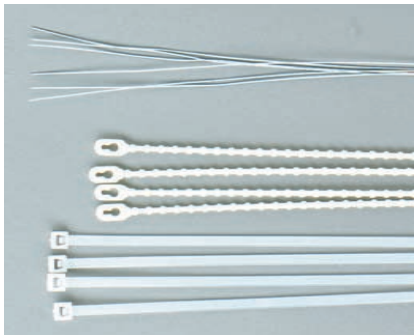

Tag Fasteners

- Three fastener styles available to meet every application
- Nylon fasteners meet OSHA requirements for attaching tagout devices

Catalog #	Description	Qty.
81760	12 in. 26 Gauge Wire	100
81761	8 in. Reusable Beaded Ties	100
81762	7 in. Nylon Fasteners	100

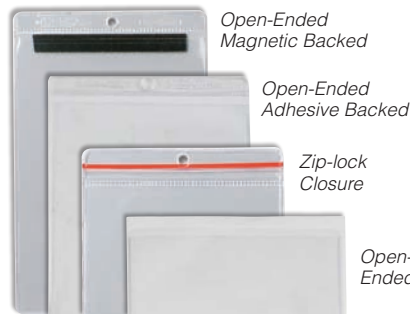

Protective Envelopes

- Transparent, durable vinyl construction
- Ideal for indoor or outdoor use
- Protects tags and cards on machinery, valves, switches, controls and more

Catalog #	Description	Size	Qty.
81769	Magnetic Backed	4.5 in. x 6.5 in.	10
81770	Magnetic Backed	5.5 in. x 8.5 in.	10
81771	Adhesive Backed	4.5 in. x 6.5 in.	10
81772	Adhesive Backed	5.5 in. x 8.5 in.	10
81765	Zip-lock w/o Grommet	4.5 in. x 6.5 in.	10
81767	Zip-lock w/o Grommet	5.5 in. x 8.5 in.	10
81766	Zip-lock w/ Grommet	4.5 in. x 6.5 in.	10
81768	Zip-lock w/ Grommet	5.5 in. x 8.5 in.	10
81763	Open-Ended	4.5 in. x 6.5 in.	10
81764	Open-Ended	5.5 in. x 8.5 in.	10



Fluorescent Protective Envelopes

- Transparent, durable vinyl construction
- Fluorescent edging is ideal for color-coding work in process, machine procedures and drawings

Catalog #	Size	Color	Qty.
56941	9 in. x 9 in.	Fluorescent Green	25
56945	9 in. x 12 in.	Fluorescent Green	25
56942	9 in. x 9 in.	Fluorescent Orange	25
56946	9 in. x 12 in.	Fluorescent Orange	25
56944	9 in. x 9 in.	Fluorescent Yellow	25
56948	9 in. x 12 in.	Fluorescent Yellow	25

Valve Tags

BradyID.com/s36

Valve Identification

Valve tags help relay important pipe content information, valve identification or operation information at the point of need. Some stock valve tag options, like our brass valve tags and energy source tags, are available with preset legends. All of our tags are available for customization or as blanks so you may stamp or print your own tag text or legends.



ASME A13.1

Recommends the use of a permanently legible tag for identification of materials in pipes less than 3/4 in. (19 mm) in diameter.

	High-Performance Material				General-Purpose Material					
	HEET Tag B-748	Coated Aluminum B-541	Fiberglass B-120	Plastic Tag B-418	Brass B-907	Aluminum B-906	Stainless Steel B-919	3-Ply Engraved B-1	Polyester B-851	Polyurethane B-462
Environment										
Indoor	Good	Good	Good	Good	Good	Good	Good	Good	Good	Good
Avg. Outdoor Durability (yrs)	5-7	Up to 10	15	5-7**	3-6	Up to 2	5-7	5-8	3-5	5-7
Surface Abrasion Resistance	Good	Good	Good	Good	Good	Good	Good	Good	Fair	Good
Temperatures										
Upper Limit	248° F (120°)	500° F (260° C)	193° F (89° C)	260° F (127° C)	233° F (113° C)	233° F (113° C)	1500° F (815° C)	193° F (89° C)	212° F (100° C)	250° F (121° C)
Lower Limit	-40° F (40° C)	-40° F (40° C)	-40° F (40° C)	-40° F (40° C)	-40° F (40° C)	-40° F (40° C)	-40° F (40° C)	-40° F (40° C)	-40° F (40° C)	-40° F (40° C)
Chemical Resistance										
Organic Solvents (MEK, Acetone, Toluene)	Not Rec.	Good	Not Rec.	Not Rec.	Not Rec.	Not Rec.	Good	Not Rec.	Not Rec.	Not Rec.
Acids (Sulfuric, HCl, Acetic)	Good	Not Rec.	Not Rec.	Good	Not Rec.	Not Rec.	Not Rec.	Not Rec.	Good	Good
Alkali (Sodium Hydroxide)	Not Rec.	Not Rec.	Not Rec.	Good	Not Rec.	Not Rec.	Not Rec.	Good	Good	Good
Alcohols (Methanol, Isopropanol)	Not Rec.	Good	Good	Good	Good	Not Rec.	Good	Good	Good	Good
Grease/Oils (SAE 20, ASTM#3)	Good	Good	Good	Good	Good	Good	Good	Good	Good	Good
Special Properties										
Bar Coding Available	Yes	Yes	No	Yes	No	No	No	No	Yes	No
Protective Covering Available	Yes	No	No	Yes	No	No	No	No	Yes	No

** Includes overlaminated Not Rec. = Not Recommended

Valve Tags



Custom Valve Tags

Brady offers a wide variety of customizable valve tags to meet your needs and the harsh environments throughout your facility. View the available tag types, then contact Brady Customer Service to order your custom tags today.

Contact Customer Service to order your custom tags



HEET Tags (B-748)

- Features overlaminated polyester which permanently bonds graphics to a stainless steel baseplate
- Optional protective tag covers are available to maintain readability even when covered with paint
- Custom text on one or both sides
- Sizes: 2 in. x 2 in. or 2.5 in. x 5 in.
- Available colors: yellow, red, green, blue or white



Durable Rigid Plastic Tags (B-418)

- Colorful plastic tag has recessed area on both sides to apply printed label
- Non-corrosive, lightweight, non-conductive and impact resistant
- Available with either 1.5 in. x 3 in. or 2.5 in. x 4 in. label area
- Overlaminated choices include standard or UV resistant for durability
- Tags can be purchased individually
- Available colors: black, yellow, red, blue, green, orange, white, gray, brown and tan



Coated Aluminum Tags (B-541)

- Anodized aluminum printed with black text and coated with flourinated polyethylene; resists corrosion, paint, chemicals and sunlight
- Legends, barcodes and human readable text available with variable print
- Fixed custom message, warning or logo may be added to all tags
- Sizes: 1.5 in. x 1.5 in. or 1 in. x 3 in.



Stamped and Engraved Brass Tags (B-907)

- 19 gauge cartridge brass (40-mil thick) for general purpose valve identification
- Available in 1.5 in. and 2 in. round, square, triangle or octagon / hexagon shapes
- Available in natural color or black-filled. All tags are produced natural unless requested. Black-filled legend is recommended for maximum legibility
- Stamping or engraving options available



Fiberglass Tags (B-120)

- Graphics are embedded within a fiberglass / resin package in order to withstand moisture, grease and dirt
- Standard colors are yellow and white
- Ability to add multiple lines of text
- Sizes: 2 in. x 2 in. or 4 in. x 4 in. Custom sizes and colors available



Stamped and Engraved Aluminum Tags (B-906)

- Durable 19 gauge aluminum tags
- Type 3003-H14 material has been anodized, dyed and sealed
- Available in round or square shapes in either 1.5 in. or 2 in. sizes.
- Available in natural color or black-filled. All tags are produced natural unless requested. Black-filled legend is recommended for maximum legibility
- Stamping, engraving or etching options available

Custom Valve Tags

BradyID.com/s36

Custom Valve Tags (continued)



Stainless Steel (B-919)

- Durable .025 in. stainless steel tags
- Pre-stamped tags may be black filled for easier readability
- Equipment tags are surface coated with ink and then engraved
- Available in round or square shapes in either 1.5 in. or 2 in. sizes
- Withstands temperatures of 2,700° F
- Stamping, engraving or etching options available



3-Ply Engraved (B-1)

- Rigid laminate plastic is heat resistant, non-conductive and non-corroding
- Tag text engraved through a colored cap sheet to a contrasting colored base sheet
- Multiple background colors available
- Round size: 1.5 in. or 2 in.
- Square size options:
0.75 in. x 2.5 in. 1 in. x 2.5 in.
1 in. x 3 in. 2 in. x 3 in.
1.5 in. x 4 in. 2 in. x 4 in.
- Hole size: 3/16 in.



Polyester (B-851)

- Grommated heavy duty polyester tags withstand moisture, grease and dirt
- Rigid polyester surface exceeds OSHA 50-lb. pull out requirement
- Polyester tags withstand moisture, grease and dirt
- Provides good outdoor UV resistance
- Ability to add barcodes and multiple lines of text
- Standard colors include: red, yellow, blue, green and white

Grade 316 Stainless Steel Tags and Ties (B-7316)

Designed to withstand extreme temperatures, harsh chemicals and to offer excellent outdoor durability

- Service temperature of -112°F to 1,000°F (-80°C to 815°C)
- Blank stock tags can be embossed or laser-engraved, and offer excellent clarity and print permanence. Tags can also be ordered with custom legends
- Easy installation with the cable tie tool, capable of both cinching and cutting ties (sold separately)



Cable tie tool with teeth

Stainless Steel Tags

Catalog #	Size	Qty
SSTAG-5219-7316	2.040 in. x 0.740 in.	100/pk
SSTAG-7010-7316	2.756 in. x 0.394 in.	100/pk
SSTAG-7013-7316	2.756 in. x 0.512 in.	100/pk
SSTAG-9010-7316	3.543 in. x 0.394 in.	100/pk
SSTAG-11010-7316	4.331 in. x 0.394 in.	100/pk
SSTAG-11013-7316	4.331 in. x 0.512 in.	100/pk

Stainless Steel Ties

Catalog #	Size	Qty
SSTIE-127-7316	0.181 in. x 5.00 in.	100/pk
SSTIE-201-7316	0.181 in. x 7.913 in.	100/pk
SSTIEC-201-7316	0.181 in. x 7.913 in.	100/pk
SSTIE-300-7316	0.181 in. x 11.811 in.	100/pk
SSTIE-370-7316	0.181 in. x 14.566 in.	100/pk
SSTIEC-370-7316	0.181 in. x 14.566 in.	100/pk
SSTIE-520-7316	0.181 in. x 20.472 in.	100/pk
SSTIE-150-7316-HD	0.311 in. x 5.905 in.	100/pk
SSTIE-201-7316-HD	0.311 in. x 7.913 in.	100/pk
SSTIE-300-7316-HD	0.311 in. x 11.811 in.	100/pk
SSTIEC-362-7316	0.311 in. x 14.251 in.	100/pk
SSTIE-370-7316-HD	0.311 in. x 14.566 in.	100/pk
SSTIE-520-7316-HD	0.311 in. x 20.472 in.	100/pk
SSTIEC-520-7316	0.311 in. x 20.472 in.	100/pk
SSTIE-840-7316-HD	0.311 in. x 33.07 in.	100/pk

Cable-Tie Tools

Catalog #	Size	Qty
JV-4580	Heavy Duty Cable Tie Tool	1
JV-4580MG	Heavy Duty Cable Tie Tool w/Teeth	1

Stamped Brass Valve Tags (B-907)

- 1.5 in. diameter stamped valve tags
- Constructed from 19 gauge cartridge brass (40-mils thick)
- Black-filled text for easy readability
- Text size: 0.25 in. top legend; 0.5 in. number sequence
- Standard package: 25 tags (one each of sequence)

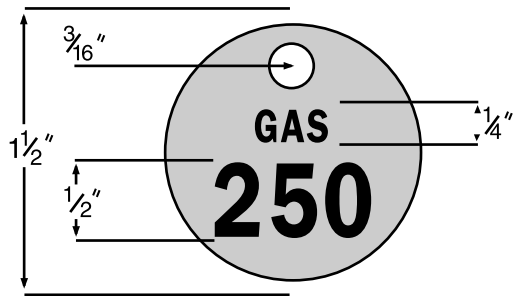

Contact Brady to customize

Top Line Copy	1-25	26-50	51-75	76-100	101-125	126-150	151-175	176-200	201-225	226-250	251-275	276-300	301-325	326-350	351-375	376-400	401-425	426-450	451-475	476-500
(Blank)	23200	23201	23202	23203	23204	23205	23206	23207	23208	23209	23617	23618	23619	23620	23621	23622	23623	23624	23625	23626
AC	23272	23273	23274	23275	23480	23481	23482	23483	23484	23485	23486	23487	23488	23489	23490	23491	23492	23493	23494	23495
CA	87460	87461	87462	87463	87464	87465	87466	87467	87468	87469	87470	87471	87472	87473	87474	87475	87476	87477	87478	87479
CHW	23516	23517	23518	23519	23520	23521	23522	23523	23524	23525	23526	23527	23528	23529	23530	23531	23532	23533	23534	23535
CHWR	23596	23597	23598	23599	23600	23601	23602	23603	23604	23605	23606	23607	23608	23609	-	-	-	-	-	-
CHWS	23576	23577	23578	23579	23580	23581	23582	23583	23584	23585	-	23587	23588	23589	-	-	-	-	-	-
COND	23647	23648	23649	23650	23651	23652	23653	23654	23655	23656	23657	23658	-	23660	23661	23662	23663	23664	23665	23666
CW	23256	23257	23258	23259	23400	23401	23402	23403	23404	23405	23406	23407	23408	23409	23410	23411	23412	23413	23414	23415
CWR	87100	87101	87102	87103	87104	87105	87106	87107	87108	87109	87110	87111	87112	87113	87114	87115	87116	87117	87118	87119
CWS	87120	87121	87122	87123	87124	87125	87126	87127	87128	87129	87130	87131	87132	87133	87134	87135	87136	87137	87138	87139
DCW	87200	87201	87202	87203	87204	87205	87206	87207	87208	87209	87300	87302	87303	87304	87305	87306	87307	87308	87309	87310
DCWR	87331	87332	87333	87334	87335	87336	87337	87338	87339	87340	87341	87342	87343	87344	87345	87346	87347	87348	87349	87350
DCWS	87371	87372	87373	87374	87375	87376	87377	87378	87379	87380	87381	87382	87383	87384	87385	87386	87387	87388	87389	87942
DHW	87180	87181	87182	87183	87184	87185	87186	87187	87188	87189	87190	87191	87192	87193	87194	87195	87196	87197	87198	87199
DHWR	87311	87312	87313	87314	87315	87316	87317	87318	87319	87320	87321	87322	87323	87324	87325	87326	87327	87328	87329	87330
DHWS	87351	87352	87353	87354	87355	87356	87357	87358	87359	87360	87361	87362	87363	87364	87365	87366	87367	87368	87369	87370
FP	23667	23668	23669	23670	23671	23672	23673	23674	23675	23676	23677	23678	23679	23680	-	23682	23683	23684	23685	23686
GAS	23264	23265	23266	23267	23448	23449	23450	23451	23452	23453	23454	23455	23456	23457	23458	23459	23460	23461	23462	23463
HPS	44720	44721	44722	44723	44724	44725	44726	44727	44728	44729	44730	-	44732	44733	44734	44735	44736	44737	44738	44739
HTG	23268	23269	23270	23271	23464	23465	23466	23467	23468	23469	23470	23471	23472	23473	23474	23475	23476	23477	23478	23479
HW	23276	23277	23278	23279	23416	23417	23418	23419	23420	23421	23422	23423	23424	23425	23426	23427	23428	-	23430	23431
HWR	23536	23537	23538	23539	23540	23541	23542	23543	23544	23545	23546	23547	23548	23549	23550	-	23552	23553	23554	23555
HWS	23556	23557	23558	23559	23560	23561	23562	23563	23564	23565	23566	23567	23568	23569	23570	23571	23572	23573	23574	23575
HVAC	87140	87141	87142	87143	87144	87145	87146	87147	87148	87149	87150	87151	87152	87153	87154	87155	87156	87157	87158	87159
LPC	87390	87391	87392	87393	87394	87395	87396	87397	87398	87399	87400	87401	87402	87403	87404	87405	87406	87407	87408	87409
LPS	44740	44741	44742	44743	44744	44745	44746	44747	44748	44749	44750	44751	44752	44753	-	44755	44756	44757	44758	44759
MPS	-	-	44702	44703	44704	44705	44706	44707	44708	44709	44710	44711	44712	44713	44714	44715	44716	44717	44718	44719
OXY	87480	87481	87482	87483	87484	87485	87486	87487	87488	87489	87490	87491	87492	87493	87494	87495	87496	87497	87498	87499
PLBG	23260	23261	23262	23263	23432	23433	23434	23435	23436	23437	23438	23439	23440	23441	23442	23443	23444	23445	23446	23447
SPK	-	-	-	23630	23631	23632	23633	23634	23635	23636	23637	23638	23639	23640	23641	23642	23643	23644	23645	23646
SPR	87160	87161	87162	87163	87164	87165	87166	87167	87168	87169	87170	87171	87172	87173	87174	87175	87176	87177	87178	87179
STM	23496	23497	23498	23499	23500	23501	23502	23503	23504	23505	23506	23507	23508	23509	23510	23511	23512	23513	23514	23515
VAC	87500	87501	87502	87503	87504	87505	87506	87507	87508	87509	87510	87511	87512	87513	87514	87515	87516	87517	87518	87519

Blank Valve Tags

BradyID.com/s36



Blank Brass Valve Tags

- Customize your own brass tags with Brady steel stamps

Catalog #	Description	Qty.
23210	1.5 in. Round Brass Tag	25
23211	2 in. Round Brass Tag	25
23212	1.5 in. Square Brass Tag	25
23213	2 in. Square Brass Tag	25



Blank Stainless Steel Tags

- B-919 tags are ideal for harsh environments or where a stainless steel material is specified
- Tag hole is 3/16 in.

Catalog #	Size	Qty.
44400	1.5 in. Round	25
44401	1.5 in. Square	25
44402	2 in. Round	25
44403	2 in. Square	25

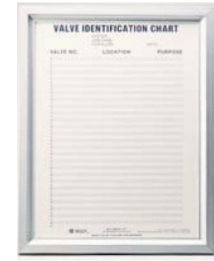

Valve Chart Frame

- Aluminum frame with plastic window displays your valve tag chart
- Chart size: 8 in. x 11 in.
- Chart lists up to 50 locations

Catalog #	Description	Qty.
23309	Valve Chart Frame	1 ea.



Blank Aluminum Tags

- Anodized aluminum B-906 is dyed to offer color-coding options not available with brass tags
- Available in round or square styles
- Standard package: 25 tags

Catalog #	2 in. Round	2 in. Square	1.5 in. Round	1.5 in. Square
Black	87612	87637	87605	87619
Blue	49907	87641	49902	87629
Green	49908	87642	49903	87630
Natural	49909	87643	49904	87631
Orange	87611	87636	87604	87618
Pink	-	87635	87603	87617
Yellow	49905	87639	49900	87627
Red	49906	87640	49901	87628



Rigid Plastic Tags

- B-418 durable plastic tags are lightweight, non-corrosive, non-conductive and impact resistant
- Withstands temps -40°F to 260°F
- Standard package: 1 each

Print Valve Tag Labels

Print custom labels with your Brady printer and attach them to these blank tags to customize.



Blank Rigid Tags

Catalog #	Color	Tag Size	Recessed Label Area
87696	White	2.1 in. x 3.6 in.	1.5 in. x 3 in.
87697	White	3.1 in. x 4.6 in.	2.5 in. x 4 in.
41922	Yellow	2.1 in. x 3.6 in.	1.5 in. x 3 in.
41923	Yellow	3.1 in. x 4.6 in.	2.5 in. x 4 in.
41924	Red	2.1 in. x 3.6 in.	1.5 in. x 3 in.
41925	Red	3.1 in. x 4.6 in.	2.5 in. x 4 in.
41926	Blue	2.1 in. x 3.6 in.	1.5 in. x 3 in.
41927	Blue	3.1 in. x 4.6 in.	2.5 in. x 4 in.
41928	Green	2.1 in. x 3.6 in.	1.5 in. x 3 in.
41929	Green	3.1 in. x 4.6 in.	2.5 in. x 4 in.
87694	Orange	2.1 in. x 3.6 in.	1.5 in. x 3 in.
87695	Orange	3.1 in. x 4.6 in.	2.5 in. x 4 in.
87712	Tan	2.1 in. x 3.6 in.	1.5 in. x 3 in.
87713	Tan	3.1 in. x 4.6 in.	2.5 in. x 4 in.
87710	Brown	2.1 in. x 3.6 in.	1.5 in. x 3 in.
87711	Brown	3.1 in. x 4.6 in.	2.5 in. x 4 in.
87698	Gray	2.1 in. x 3.6 in.	1.5 in. x 3 in.
87699	Gray	3.1 in. x 4.6 in.	2.5 in. x 4 in.
41920	Black	2.1 in. x 3.6 in.	1.5 in. x 3 in.
41921	Black	3.1 in. x 4.6 in.	2.5 in. x 4 in.
142133	Variety Pack*	-	-

* Variety Pack combines 30 tags including at least one of each size and color. Perfect for evaluating which sizes and colors you need.

Contact Brady Customer Service to customize tags for your facility.



S-Hooks

- Standard package: 100 s-hooks, sold in full packages only

Catalog #	Description	For Valve Stems Up To	Qty.
23305	1.75 in. O.D. Brass	0.5 in.	100
23304	1.5 in. O.D. Brass	0.375 in.	100
23303	1.25 in. O.D. Brass	0.25 in.	100



#16 Jack Chain

- Approximately 25 links per foot
- Standard package: 50 feet of chain, sold in full packages only

Catalog #	Description	Qty.
23308	#16 brass	50 ft.
98859	Stainless steel	50 ft.



4.5 Inch Beaded Chain

- Extremely flexible 4.5 inch bead chain with locking link
- Standard package contains 100 chains. Sold in full packages only

Catalog #	Description	Qty.
23306	4.5 in. #6 brass chain	100
23307	4.5 in. #6 nickel plate chain	100
98857	4.5 in. #6 stainless steel chain	100

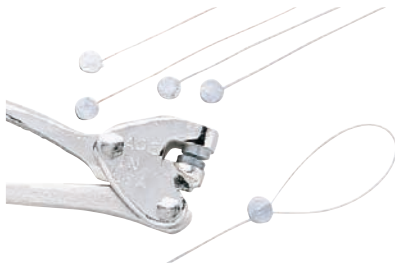

Lead Seals

- 12 in. wires with pre-fitted lead seals fit easily around pipes or valves
- Seals and Hand Sealing Press sold separately

Catalog #	Description	Qty.
23301	Copper Lead Seals	250
23302	Monel Seals	250
23300	Hand Sealing Press	1



Wire, Clamps and Tools

- Stranded stainless steel wire offers secure attachment when used with zinc clamps
- Clamps feature double ferrule design

Catalog #	Description	Qty.
38090	Zinc Wire Clamps	50
38091	48-mil Stainless Steel Wire	30 ft.
38088	Stainless Steel Wire Cutter	1



Fastening Devices

- 32-mil stainless steel safety wire to be used with wire twister pliers

Catalog #	Outside Dia.	Length
15424	Stainless Steel Safety Wire	1,800 ft



Zinc Plated Temporary Fastener

Nickel Key / Tag Ring

Tag and Key Rings

- Squeeze fastener to open and close; Inside diameter of fastener is 1.375 in.

Catalog #	Description	Qty.
58973	Nickel Key Ring	10
98858	Zinc Plated Temp. Fastener	100



Quik-Apply™ Nylon Straps

- Use with a variety of valve and lockout tagout tags

Catalog #	Outside Dia.	Strap Length
91165	1 in.	6 in.
91166	2 in.	7 in.



Colored Nylon Ties

- Use with a variety of valve and lockout tagout tags

Catalog #	Description	Length	Qty.
98848	Black	8 in.	100
98849	Blue	8 in.	100
98850	Green	8 in.	100
98851	Natural	8 in.	100
98853	Purple	8 in.	100
98854	Red	8 in.	100
98855	Yellow	8 in.	100

Pipe Marking Guide

BradyID.com/s36

Pipe Marking

ASME (ANSI) Standard A13.1-2007

The ASME (ANSI) Standard for pipe identification is a widely used guideline in determining pipe identification requirements. The purpose of the standard is to:

- Assist in identification of hazardous materials conveyed in piping systems and their hazards when released into the environment
- Pipes are defined as conduits for the transport of gases, liquids, semi-liquids or fine particulate dust



Marker placement

ASME (ANSI) A13.1-2007 visibility standard states that markers shall be located so that they are readily visible to plant personnel from the point of normal approach.

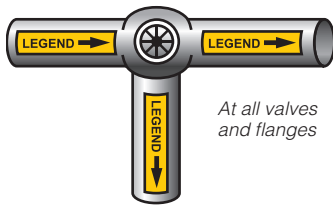

At all valves and flanges

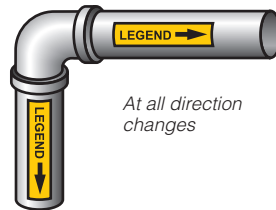

At all direction changes

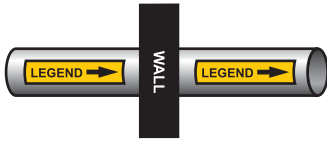

At both sides of floor or wall penetrations

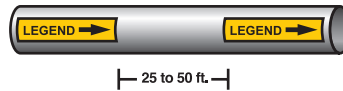

Every 25 to 50 ft. intervals on straight runs

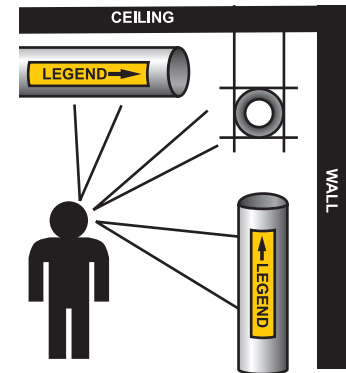

Placement of the marker may be above or below the centerline of the pipe, depending on the normal approach of personnel

Pipe Markers

Text size

The text and directional flow arrow is the primary means of identifying pipe content. A13.1-2007 standard makes recommendations as to the size of letter height and length of color field for various pipe diameters.



Outside Diameter	Length of Color Field	Size of Letters
Over 10 in.	32 in.	3.5 in.
8 in. to 10 in.	24 in.	2.5 in.
2.5 in. to 6 in.	12 in.	1.25 in.
1.5 in. to 2 in.	8 in.	0.75 in.
0.75 in. to 1.25 in.	5 in.	0.5 in.
less than 0.75 in.	Permanently legible tag recommended	

Color standards

Pipe marker colors communicate the type of contents, and are particularly important when outside agencies are called in under emergency conditions.

Pipe Classification	Color Scheme
Fire quenching fluids	White on Red
Toxic and corrosive fluids	Black on Orange
Flammable fluids	Black on Yellow
Combustible fluids	White on Brown
Potable, cooling, boiler feed and other water	White on Green
Compressed air	White on Blue

Custom colors available including gray, black, purple and clear.



B-946
Self-Sticking
Marker

B-736
Self-Sticking
Markers-To-Go

B-915
Snap-On
Marker

B-915
Strap-On
Marker

B-689
Wrap-Around
Marker

B-681 / B-883
High-Performance
High-Visibility
Marker

Overview						
Marker Type	Premium self-adhesive marker for indoor or outdoor use in either individual markers or roll-form.	Economical self-adhesive roll-form markers for smooth, clean, dry pipe surfaces.	Non-adhesive coiled pipe marker "snaps" around pipe giving 360 visibility while remaining easily removeable	Non-adhesive vinyl marker applied with nylon strapping (included).	Wrap-around marker with an adhesive edge to secure marker. Repeating legends offers 360 visibility.	Polyester marker applied to a fiberglass carrier. Markers fasten to pipe with with included mounting clips and strapping (sold separately).
Marker Material	Vinyl	Plastic Film	Vinyl	Vinyl	Polyester	Plastic Carrier
Installation Type	Adhesive	Adhesive	Snap-on	Nylon Strapping	Wrap-around with adhesive edge	Mounting clips (included) & strapping (sold separately)
Outer Diameter	From less than 0.75 in. to greater than 8 in.	-	0.75 in. to 6 in.	6 in. to 15 in.	0.2 in. to 7.875 in.	8 in. or larger
Environment						
Indoor	✓	✓	✓	✓	✓	✓
Average Outdoor Durability	3 to 5 years	2 to 3 years	5 to 8 years	5 to 8 years	5 to 8 years	5 to 8 years
Surface Abrasion Resistance	✗	✗	✗	✗	✓	✓
Dirty, Dusty Surface	✗	✗	✓	✓	✓	✓
Rough Surface	✓	✗	✓	✓	✓	✓
Insulated Surface	✓	✓	✓	✓	✓	✓
Wet Surface	✗	✗	✓	✓	✓	✓
Greasy, Oily Surface	✗	✗	✓	✓	✓	✓
Chemical Resistance						
Organic Solvents (MEK, Acetone, Toluene)	✗	✗	✗	✗	✗	✗
Acids (Sulfuric, HCL, Acetic)	✗	✓	✗	✗	✓	✓
Alkalis (Sodium Hydroxide)	✗	✗	✗	✗	✓	✓
Alcohols (Methanol, Isopropanol)	✓	✓	✓	✓	✓	✓
Grease/Oils (SAE 20, ASTM #3)	✓	✓	✓	✓	✓	✓
Temperature						
Minimum Installation Temperature	0° F (-18° C)	50° F (0° C)	-	-	40° F (5° C)	-
Service Temperature	-40° F to 180° F (-40° C to 82° C)	-40° F to 212° F (-40° C to 100° C)	-40° F to 180° F (-40° C to 82° C)	-40° F to 180° F (-40° C to 82° C)	-40° F to 248° F (-40° C to 120° C)	-40° F to 230° F (-40° C to 110° C)
Special Properties						
Low PVC - Pipe contact point	✗	✗	✗	✗	✓	✓
Low PVC - Whole marker	✗	✗	✗	✗	✗	✓
Low Halogen - Pipe contact point	✗	✗	✗	✗	✓	✓
Low Halogen - Whole marker	✗	✗	✗	✗	✗	✓
Meets ASME (ANSI) A13.1	✓	✓	✓	✓	✓	✓

IIAR Pipe Markers

BradyID.com/s36



IIAR Ammonia Refrigeration Pipe Markers

The International Institute of Ammonia Refrigeration (IIAR) standardizes pipe labeling for Ammonia Refrigeration Piping and System Components.



Ammonia piping abbreviation
*See chart below

Physical state of the refrigerant:
Liquid (LIQ)
black or white on yellow
Vapor (VAP)
black or white on sky blue
Both (LIQ and VAP)
both in colors listed above

Marker body
AMMONIA in black letters on orange background

Pressure level of the refrigerant:
HIGH
black or white on red
LOW
black or white on green
HIGH and LOW
both in colors listed above

Ammonia piping abbreviations

Abbr.	System	Abbr.	System
BD	Booster Discharge	LTRL	Low Temp. Recirculated Liquid
CD	Condenser	LTS*	Low Temp. Suction
DC	Defrost Condensate	LTRS	Low Temp. Recirculated Suction
EQ*	Equalizer	LIC	Liquid Injection Cooling
ES	Economizer Suction	LSS	Low Stage Suction
HGD	Hot Gas Defrost	PO*	Pump Out
HPL	High Pressure Liquid	PU*	Purge
HSD	High Stage Discharge	RV	Relief Vent
HSS	High Stage Suction	TSR	Thermosyphon Return
HTS*	High Temp. Suction	TSS	Thermosyphon Supply
HTRL	High Temp. Recirculated Liquid		
HTRS	High Temp. Recirculated Suction		

*Not currently covered in the IIAR standard

Orange vs. Yellow

Orange was adopted by the International Institute of Ammonia Refrigeration (IIAR) for ammonia markers, instead of yellow, because it meets the ANSI A13.1 (2007) revised standard for toxic and corrosive fluids. Yellow will continue to be available for established facilities needing replacements.



Pipe Markers

IIAR Marker Styles

Brady offers a variety of ammonia pipe markers that comply with the IIAR's established guidelines, including self-adhesive markers, snap-around marker styles and high performance pipe markers recommended for harsh environments.



IIAR B-689 High Performance Wrap-Around Marker Styles and Sizes

Style Code	Outside Diameter	Letter Height	Marker Size
Style: I	1.5 in. to 2.378 in.	0.75 in.	9 in. x 8 in. (uncoiled)
Style: II	2.5 in. to 7.875 in.	1.25 in.	26 in. x 12 in. (uncoiled)



IIAR B-681 / B-883 HPHV Marker Styles and Sizes

Style Code	Outside Diameter	Letter Height	Marker Size
Style: HPHV	8 in. or larger	3.5 in.	4 in. x 24 in. (includes 2 mounting clips)



B-946 Self-Sticking Marker Styles and Sizes

Style Code	Style Example	Outside Diameter	Letter Height	Marker Size
Style: 1HV	HEATING RETURN	8 in. or greater	3.5 in.	One 4 in. x 24 in. marker per card
Style: 1	HEATING RETURN	2.5 in. to 7.875 in.	2 in.	One 2.25 in. x 14 in. marker per card
Style: 4	FIRE AUTO SPRINKLERS	0.75 in. to 2.378 in.	0.75 in.	Four 1.125 in. x 7 in. markers per card*

* Use in conjunction with 1 in. arrow tape to meet the 8 in. marking required by ANSI standards.

Orange IIAR Pipe Markers				B-689 Wrap-Around		B-681/B-883	B-946 Self-Sticking Vinyl		
IIAR Abbr.	Physical	Legend	Pressure	Style I	Style II	Style HPHV	Style 1	Style 1HV	Style 4
(blank)	LIQ	Ammonia	High	145793	145830	145953	145866	145894	145924
(blank)	LIQ	Ammonia	Low	145789	145823	145946	145859	145888	145917
(blank)	LIQVAP	Ammonia	High	145787	145820	145943	145856	145885	145914
(blank)	LIQVAP	Ammonia	Low	145783	145817	145940	145852	145882	145911
(blank)	VAP	Ammonia	High	145778	145814	145937	145850	145876	145907
(blank)	VAP	Ammonia	Low	145771	145809	145932	145845	145873	145903
BD	VAP	Ammonia	Low	145772	145799	145926	145839	145868	145897
CD	LIQ	Ammonia	High	145795	145825	145948	145861	145890	145919
DC	LIQ	Ammonia	High	145796	145826	145949	145862	145891	145920
EQ	LIQVAP	Ammonia	Low	145784	145818	145941	145853	145883	145912
ES	VAP	Ammonia	Low	145773	145800	145927	145840	145869	145898
HGD	VAP	Ammonia	High	145780	145811	145934	145847	145878	145904
HG	VAP	Ammonia	High	145779	145810	145933	145846	145877	145908
HPL	LIQ	Ammonia	High	145797	145827	145950	145863	145896	145921
HSD	VAP	Ammonia	High	145781	145812	145935	145848	145879	145905
HSS	VAP	Ammonia	Low	145774	145802	145928	145841	145870	145899
HTRL	LIQ	Ammonia	Low	145791	145821	145944	145857	145886	145915
HTRS	LIQVAP	Ammonia	Low	145785	145815	145938	145851	145880	145909
HTS	VAP	Ammonia	Low	145775	145805	145929	145842	145871	145900
LIC	LIQ	Ammonia	High	145798	145828	145951	145864	145892	145922
LSS	VAP	Ammonia	Low	145776	145807	145930	145843	145872	145901
LTRL	LIQ	Ammonia	Low	145788	145822	145945	145858	145887	145916
LTRS	LIQVAP	Ammonia	Low	145782	145816	145939	145854	145881	145910
LTS	VAP	Ammonia	Low	145770	145808	145931	145844	145874	145902
PO	LIQ	Ammonia	Low	145790	145824	145947	145860	145889	145918
PU	LIQ	Ammonia	High	145794	145831	145954	145867	145895	145925
PV	VAP	Ammonia	High	145777	145813	145936	145849	145875	145906
TSR	LIQVAP	Ammonia	High	145786	145819	145942	145855	145884	145913
TSS	LIQ	Ammonia	High	145792	145829	145952	145865	145893	145923

Yellow IIAR Pipe Markers

For established facilities needing replacements.

Yellow IIAR Pipe Markers				B-689 Wrap-Around		B-681/B-883	B-946 Self-Sticking Vinyl		
IIAR Abbr.	Physical	Legend	Pressure	Style I	Style II	Style HPHV	Style 1	Style 1HV	Style 4
(blank)	LIQ	Ammonia	High	58000	58006	59939	90462	90460	90461
(blank)	LIQ	Ammonia	Low	58003	58009	59942	90465	90463	90464
(blank)	LIQVAP	Ammonia	High	58002	58008	59941	90474	90472	90473
(blank)	LIQVAP	Ammonia	Low	58005	58011	59944	90477	90475	90476
(blank)	VAP	Ammonia	High	58001	58007	59940	90468	90466	90467
(blank)	VAP	Ammonia	Low	58004	58010	59943	90471	90469	90470
BD	VAP	Ammonia	Low	57960	57980	59919	90440	90400	90420
CD	LIQ	Ammonia	High	57961	57981	59920	90441	90401	90421
DC	LIQ	Ammonia	High	57962	57982	59921	90442	90402	90422
EQ	LIQVAP	Ammonia	Low	58014	58017	59982	90486	90484	90485
ES	VAP	Ammonia	Low	57963	57983	59922	90443	90403	90423
HGD	VAP	Ammonia	High	57965	57985	59924	90445	90405	90425
HG	VAP	Ammonia	High	57964	57984	59923	90444	90404	90424
HPL	LIQ	Ammonia	High	57966	57986	59925	90446	90406	90426
HSD	VAP	Ammonia	High	57967	57987	59926	90447	90407	90427
HSS	VAP	Ammonia	Low	57968	57988	59927	90448	90408	90428
HTRL	LIQ	Ammonia	Low	57969	57989	59928	90449	90409	90429
HTRS	LIQVAP	Ammonia	Low	57970	57990	59929	90450	90410	90430
HTS	VAP	Ammonia	Low	57971	57991	59930	90451	90411	90431
LIC	LIQ	Ammonia	High	57972	57992	59931	90452	90412	90432
LSS	VAP	Ammonia	Low	57973	57993	59932	90453	90413	90433
LTRL	LIQ	Ammonia	Low	57974	57994	59933	90454	90414	90434
LTRS	LIQVAP	Ammonia	Low	57975	57995	59934	90455	90415	90435
LTS	VAP	Ammonia	Low	57976	57996	59935	90456	90416	90436
PO	LIQ	Ammonia	Low	58012	58015	59980	90480	90478	90479
PU	LIQ	Ammonia	High	58013	58016	59981	90483	90481	90482
PV	VAP	Ammonia	High	57977	57997	59936	90457	90417	90437
TSR	LIQVAP	Ammonia	High	57978	57998	59937	90458	90418	90438
TSS	LIQ	Ammonia	High	57979	57999	59938	90459	90419	90439

Pipe Markers



IIAR Component Markers

Legend	Pressure	Yellow Style 1HV	Orange Style 1HV
ACCUMULATOR	Low	90340	145832
COMPRESSOR	High	90341	145836
EVAPORATOR	Low	90350	145833
HEAT EXCHANGER	Low	90343	145834
OIL SEPARATOR	High	90349	145837
RECEIVER	High	90345	145838
RECIRCULATOR	Low	90346	145835

Self-Sticking Pipe Markers

BradyID.com/s36

Self-Sticking Vinyl Pipe Markers (B-946)

- Markers meet the requirements of the ASME (ANSI) A13.1 Standard for the identification of piping system contents when used with directional flow arrow tape
- Durable B-946 material ideal for indoor and outdoor environments
- Supplied on a coated backing material that makes handling and installation easy



Marker Styles and Sizes

Style Code	Style Example	Outside Diameter	Letter Height	Marker Size
Style: 1HV	HEATING RETURN	8 in. or greater	3.5 in.	One 4 in. x 24 in. marker per card
Style: 1	HEATING RETURN	2.5 in. to 7.875 in.	2 in.	One 2.25 in. x 14 in. marker per card
Style: 3C		less than 0.75 in	0.3 in	Three 2.25 in. x 2.75 in markers per card plus 8 strips of arrow tape
Style: 4		0.75 in. to 2.378 in.	0.75 in.	Four 1.125 in. x 7 in. markers per card*

* Use in conjunction with 1 in. arrow tape to meet the ANSI marking requirement of 8 in.

Self-Sticking Pipe Marker Legends

Legend	Color	Style 1HV	Style 1	Style 3C	Style 4
(Blank)	Blue	7021-1HV	7021-1	7021-3C	7021-4
(Blank)	Green	7022-1HV	7022-1	7022-3C	7022-4
(Blank)	Orange	7023-1HV	7023-1	7023-3C	7023-4
(Blank)	Red	7024-1HV	7024-1	7024-3C	7024-4
(Blank)	White	7026-1HV	7026-1	7026-3C	7026-4
(Blank)	Yellow	7025-1HV	7025-1	7025-3C	7025-4
° C	Yellow	7307-1HV	7307-1	7307-3C	7307-4
° F	Yellow	7308-1HV	7308-1	7308-3C	7308-4
Kg/Cm2	Yellow	-	91834	-	91835
LB. Steam	Green	7427-1HV	7427-1	7427-3C	7427-4
LB. Steam	Yellow	7309-1HV	7309-1	7309-3C	7309-4
PSI	Yellow	7310-1HV	7310-1	7310-3C	7310-4
Acetone	Yellow	7000-1HV	7000-1	7000-3C	7000-4
Acetylene Gas	Brown	7317-1HV	7317-1	7317-3C	7317-4
Acetylene Gas	Yellow	7001-1HV	7001-1	7001-3C	7001-4
Acid	Orange	7318-1HV	7318-1	7318-3C	7318-4
Acid	Yellow	7002-1HV	7002-1	7002-3C	7002-4
Acid Vent	Orange	7319-1HV	7319-1	7319-3C	7319-4
Acid Vent	Yellow	7003-1HV	7003-1	7003-3C	7003-4
Acid Waste	Orange	7320-1HV	7320-1	7320-3C	7320-4
Acid Waste	Yellow	7004-1HV	7004-1	7004-3C	7004-4
Air	Blue	7006-1HV	7006-1	7006-3C	7006-4
Air	Green	7007-1HV	7007-1	7007-3C	7007-4
Air	Yellow	7005-1HV	7005-1	7005-3C	7005-4
Air Return	Blue	7008-1HV	7008-1	7008-3C	7008-4
Air Return	White	7009-1HV	7009-1	7009-3C	7009-4
Air Supply	Blue	7010-1HV	7010-1	7010-3C	7010-4
Air Supply	White	7011-1HV	7011-1	7011-3C	7011-4
Alcohol	Yellow	7012-1HV	7012-1	7012-3C	7012-4
Alum	Yellow	7013-1HV	7013-1	7013-3C	7013-4
Ammonia	Orange	7321-1HV	7321-1	7321-3C	7321-4
Ammonia	Yellow	7014-1HV	7014-1	7014-3C	7014-4
Argon	Blue	7016-1HV	7016-1	7016-3C	7016-4
Argon	Brown	7322-1HV	7322-1	7322-3C	7322-4
Argon	Green	7015-1HV	7015-1	7015-3C	7015-4
Asbestos Free	Blue	7017-1HV	7017-1	7017-3C	7017-4
Asbestos Free Insulation	Blue	7018-1HV	7018-1	7018-3C	7018-4
Asbestos Insulation	Yellow	7019-1HV	7019-1	7019-3C	7019-4
Backwash	Green	7020-1HV	7020-1	7020-3C	7020-4
Black Liquor	Orange	7324-1HV	7324-1	7324-3C	7324-4
Black Liquor	Yellow	8782-1HV	8782-1	8782-3C	8782-4
Bleach Liquor	Orange	7325-1HV	7325-1	7325-3C	7325-4
Bleach Liquor	Yellow	8783-1HV	8783-1	8783-3C	8783-4
Blow Off Water	Green	7326-1HV	7326-1	7326-3C	7326-4
Blow Off Water	Yellow	7027-1HV	7027-1	7027-3C	7027-4
Blowdown	Yellow	7028-1HV	7028-1	7028-3C	7028-4
Blowdown	Green	7327-1HV	7327-1	7327-3C	7327-4

Legend	Color	Style 1HV	Style 1	Style 3C	Style 4
Blower Air	Blue	7329-1HV	7329-1	7329-3C	7329-4
Blower Air	Green	7029-1HV	7029-1	7029-3C	7029-4
Blower Air	Red	7330-1HV	7330-1	7330-3C	7330-4
Boiler Blowdown	Green	7331-1HV	7331-1	7331-3C	7331-4
Boiler Blowdown	Yellow	7030-1HV	7030-1	7030-3C	7030-4
Boiler Feed	Green	7032-1HV	7032-1	7032-3C	7032-4
Boiler Feed	Yellow	7031-1HV	7031-1	7031-3C	7031-4
Boiler Feed Water	Green	7332-1HV	7332-1	7332-3C	7332-4
Boiler Feed Water	Yellow	7033-1HV	7033-1	7033-3C	7033-4
Boiler Water	Green	7034-1HV	7034-1	7034-3C	7034-4
Bop Control	Yellow	-	131048	-	131053
Breathing Air	Blue	7334-1HV	7334-1	7334-3C	7334-4
Breathing Air	Green	7035-1HV	7035-1	7035-3C	7035-4
Breathing Air	Red	7335-1HV	7335-1	7335-3C	7335-4
Brine	Green	7036-1HV	7036-1	7036-3C	7036-4
Brine	Orange	7336-1HV	7336-1	7336-3C	7336-4
Carbon Dioxide	Brown	7338-1HV	7338-1	7338-3C	7338-4
Carbon Dioxide	Gray	-	-	87740	90307
Carbon Dioxide	Red	7039-1HV	7039-1	7039-3C	7039-4
Carbon Dioxide	Yellow	7038-1HV	7038-1	7038-3C	7038-4
Caustic	Orange	7339-1HV	7339-1	7339-3C	7339-4
Caustic	Yellow	7040-1HV	7040-1	7040-3C	7040-4
Caustic Soda	Orange	7340-1HV	7340-1	7340-3C	7340-4
Caustic Soda	Yellow	7041-1HV	7041-1	7041-3C	7041-4
Caution Asbestos	Yellow	97542	97543	-	-
Caution Asbestos Hazard Do Not Distrub Without Pro	Yellow	97627	97628	-	-
Chemical	Orange	7341-1HV	7341-1	7341-3C	7341-4
Chemical	Yellow	7042-1HV	7042-1	7042-3C	7042-4
Chemical Feed	Orange	7342-1HV	7342-1	7342-3C	7342-4
Chemical Feed	Yellow	7043-1HV	7043-1	7043-3C	7043-4
Chilled Hot Water	Green	7044-1HV	7044-1	7044-3C	7044-4
Chilled Water	Green	7045-1HV	7045-1	7045-3C	7045-4
Chilled Water Return	Green	7046-1HV	7046-1	7046-3C	7046-4
Chilled Water Supply	Green	7047-1HV	7047-1	7047-3C	7047-4
Chlorine	Orange	7343-1HV	7343-1	7343-3C	7343-4
Chlorine	Yellow	7048-1HV	7048-1	7048-3C	7048-4
Chlorine Gas	Brown	7344-1HV	7344-1	7344-3C	7344-4
Chlorine Gas	Yellow	7049-1HV	7049-1	7049-3C	7049-4
Chlorine Solution	Orange	7345-1HV	7345-1	7345-3C	7345-4
Chlorine Solution	Yellow	7050-1HV	7050-1	7050-3C	7050-4
Circulating Water	Green	7051-1HV	7051-1	7051-3C	7051-4
Circulating Water	Yellow	7052-1HV	7052-1	7052-3C	7052-4
City Gas	Brown	7346-1HV	7346-1	7346-3C	7346-4
City Gas	Yellow	7053-1HV	7053-1	7053-3C	7053-4
City Water	Green	7054-1HV	7054-1	7054-3C	7054-4
Cold Water	Green	7055-1HV	7055-1	7055-3C	7055-4
Cold Water Return	Green	7056-1HV	7056-1	7056-3C	7056-4

Self-Sticking Pipe Markers

BradyID.com/s36

Self-Sticking Pipe Marker Legends (continued)

Legend	Color	Style 1HV	Style 1	Style 3C	Style 4
Cold Water Supply	Green	7057-1HV	7057-1	7057-3C	7057-4
Compressed Air	Blue	7060-1HV	7060-1	7060-3C	7060-4
Compressed Air	Green	7059-1HV	7059-1	7059-3C	7059-4
Compressed Air	Yellow	7058-1HV	7058-1	7058-3C	7058-4
Condensate	Brown	7348-1HV	7348-1	7348-3C	7348-4
Condensate	Yellow	7061-1HV	7061-1	7061-3C	7061-4
Condensate Drain	Green	7063-1HV	7063-1	7063-3C	7063-4
Condensate Drain	Yellow	7062-1HV	7062-1	7062-3C	7062-4
Condensate Pump Discharge	Brown	7347-1HV	7347-1	7347-3C	7347-4
Condensate Pump Discharge	Yellow	7064-1HV	7064-1	7064-3C	7064-4
Condensate Return	Green	7349-1HV	7349-1	7349-3C	7349-4
Condensate Return	Yellow	7065-1HV	7065-1	7065-3C	7065-4
Condensate Supply	Yellow	7066-1HV	7066-1	7066-3C	7066-4
Condenser Water	Green	7067-1HV	7067-1	7067-3C	7067-4
Condenser Water Return	Green	7068-1HV	7068-1	7068-3C	7068-4
Condenser Water Supply	Green	7069-1HV	7069-1	7069-3C	7069-4
Cooling Water	Green	7070-1HV	7070-1	7070-3C	7070-4
Cooling Water Return	Green	7071-1HV	7071-1	7071-3C	7071-4
Cooling Water Supply	Green	7072-1HV	7072-1	7072-3C	7072-4
Crude Oil	Yellow	8784-1HV	8784-1	8784-3C	8784-4
Cyclopropane	Orange	-	90308	-	-
Danger Asbestos	Yellow	97544	97545	-	-
Deionized Water	Green	7073-1HV	7073-1	7073-3C	7073-4
Deionized Water Return	Green	7074-1HV	7074-1	7074-3C	7074-4
Deionized Water Supply	Green	7075-1HV	7075-1	7075-3C	7075-4
Diesel Oil	Yellow	7078-1HV	7078-1	7078-3C	7078-4
Digested Sludge	Yellow	7076-1HV	7076-1	7076-3C	7076-4
Digester Gas	Yellow	7077-1HV	7077-1	7077-3C	7077-4
Discharge	Green	7080-1HV	7080-1	7080-3C	7080-4
Discharge	Yellow	7079-1HV	7079-1	7079-3C	7079-4
Distilled Water	Green	7081-1HV	7081-1	7081-3C	7081-4
Do Not Paint	Red	150681	150683	150684	150682
Dom Cold Water	Green	-	103553	-	-
Dom Hot Water	Yellow	-	103554	-	103549
Domestic	Green	7083-1HV	7083-1	7083-3C	7083-4
Domestic	Yellow	7082-1HV	7082-1	7082-3C	7082-4
Domestic Cold Water	Green	7084-1HV	7084-1	7084-3C	7084-4
Domestic Cold Water Return	Green	7085-1HV	7085-1	7085-3C	7085-4
Domestic Cold Water Supply	Green	7086-1HV	7086-1	7086-3C	7086-4
Domestic Hot Water	Green	7350-1HV	7350-1	7350-3C	7350-4
Domestic Hot Water	Yellow	7087-1HV	7087-1	7087-3C	7087-4
Domestic Hot Water Return	Green	7351-1HV	7351-1	7351-3C	7351-4
Domestic Hot Water Return	Yellow	7088-1HV	7088-1	7088-3C	7088-4
Domestic Hot Water Supply	Green	7352-1HV	7352-1	7352-3C	7352-4
Domestic Hot Water Supply	Yellow	7089-1HV	7089-1	7089-3C	7089-4
Drain	Green	7090-1HV	7090-1	7090-3C	7090-4
Drain	Yellow	7091-1HV	7091-1	7091-3C	7091-4
Drain Water	Green	7092-1HV	7092-1	7092-3C	7092-4
Drilling Mud	Yellow	-	131047	-	131052
Drinking Water	Green	7093-1HV	7093-1	7093-3C	7093-4
Dual Temperature	Green	7353-1HV	7353-1	7353-3C	7353-4
Dual Temperature	Yellow	7094-1HV	7094-1	7094-3C	7094-4
Dye	Yellow	8785-1HV	8785-1	8785-3C	8785-4
Effluent	Yellow	7095-1HV	7095-1	7095-3C	7095-4
Electric Traced	Orange	7097-1HV	7097-1	7097-3C	7097-4
Electric Traced	Yellow	7096-1HV	7096-1	7096-3C	7096-4
Engine Oil	Yellow	8786-1HV	8786-1	8786-3C	8786-4
Exhaust	Blue	7354-1HV	7354-1	7354-3C	7354-4
Exhaust	Green	7099-1HV	7099-1	7099-3C	7099-4
Exhaust	Yellow	7098-1HV	7098-1	7098-3C	7098-4
Exhaust Air	Blue	7100-1HV	7100-1	7100-3C	7100-4
Exhaust Air	White	7101-1HV	7101-1	7101-3C	7101-4
Exhaust Intake	Blue	7102-1HV	7102-1	7102-3C	7102-4
Feed	Green	7104-1HV	7104-1	7104-3C	7104-4
Feed	Yellow	7103-1HV	7103-1	7103-3C	7103-4
Filtered Water	Green	7105-1HV	7105-1	7105-3C	7105-4
Filtrate	Green	7355-1HV	7355-1	7355-3C	7355-4
Filtrate	Yellow	7106-1HV	7106-1	7106-3C	7106-4
Fire Auto Sprinklers	Red	7107-1HV	7107-1	7107-3C	7107-4
Fire Dry Standpipe	Red	7108-1HV	7108-1	7108-3C	7108-4
Fire Main	Red	7109-1HV	7109-1	7109-3C	7109-4
Fire Protection	Red	-	103551	-	103546
Fire Protection Water	Red	7110-1HV	7110-1	7110-3C	7110-4

Legend	Color	Style 1HV	Style 1	Style 3C	Style 4
Floor Drain	Green	7111-1HV	7111-1	7111-3C	7111-4
Floor Drain	Yellow	7356-1HV	7356-1	7356-3C	7356-4
Freon	Green	7112-1HV	7112-1	7112-3C	7112-4
Fresh Water	Green	7113-1HV	7113-1	7113-3C	7113-4
Fuel Gas	Brown	7357-1HV	7357-1	7357-3C	7357-4
Fuel Gas	Yellow	7114-1HV	7114-1	7114-3C	7114-4
Fuel Oil	Yellow	7115-1HV	7115-1	7115-3C	7115-4
Fuel Oil Return	Yellow	7116-1HV	7116-1	7116-3C	7116-4
Fuel Oil Supply	Yellow	7117-1HV	7117-1	7117-3C	7117-4
Fuel Oil Vent	Yellow	7118-1HV	7118-1	7118-3C	7118-4
Gas	Brown	7358-1HV	7358-1	7358-3C	7358-4
Gas	Yellow	7119-1HV	7119-1	7119-3C	7119-4
Gas - Air	Yellow	-	131050	-	131055
Gas - Mist	Yellow	-	131051	-	131056
Gasoline	Brown	7359-1HV	7359-1	7359-3C	7359-4
Gasoline	Yellow	7120-1HV	7120-1	7120-3C	7120-4
Glycol	Brown	8779-1HV	8779-1	8779-3C	8779-4
Glycol	Yellow	7121-1HV	7121-1	7121-3C	7121-4
Glycol Return	Brown	8780-1HV	8780-1	8780-3C	8780-4
Glycol Return	Yellow	7122-1HV	7122-1	7122-3C	7122-4
Glycol Supply	Brown	8781-1HV	8781-1	8781-3C	8781-4
Glycol Supply	Yellow	7123-1HV	7123-1	7123-3C	7123-4
Green Liquor	Orange	7360-1HV	7360-1	7360-3C	7360-4
Green Liquor	Yellow	8787-1HV	8787-1	8787-3C	8787-4
Halon	Red	8788-1HV	8788-1	8788-3C	8788-4
Heating	Green	7361-1HV	7361-1	7361-3C	7361-4
Heating	Yellow	7124-1HV	7124-1	7124-3C	7124-4
Heating Return	Green	7362-1HV	7362-1	7362-3C	7362-4
Heating Return	Yellow	7125-1HV	7125-1	7125-3C	7125-4
Heating Steam	Yellow	7126-1HV	7126-1	7126-3C	7126-4
Heating Supply	Green	7363-1HV	7363-1	7363-3C	7363-4
Heating Supply	Yellow	7127-1HV	7127-1	7127-3C	7127-4
Heating Water	Green	7364-1HV	7364-1	7364-3C	7364-4
Heating Water	Yellow	7128-1HV	7128-1	7128-3C	7128-4
Heating Water Return	Green	7365-1HV	7365-1	7365-3C	7365-4
Heating Water Return	Yellow	7129-1HV	7129-1	7129-3C	7129-4
Heating Water Supply	Green	7366-1HV	7366-1	7366-3C	7366-4
Heating Water Supply	Yellow	7130-1HV	7130-1	7130-3C	7130-4
Helium	Blue	7133-1HV	7133-1	7133-3C	7133-4
Helium	Brown	-	-	87742	-
Helium	Green	7132-1HV	7132-1	7132-3C	7132-4
High Pressure	Yellow	7134-1HV	7134-1	7134-3C	7134-4
High Pressure Air	Blue	7367-1HV	7367-1	7367-3C	7367-4
High Pressure Air	Green	7136-1HV	7136-1	7136-3C	7136-4
High Pressure Air	Yellow	7135-1HV	7135-1	7135-3C	7135-4
High Pressure Condensate	Yellow	7137-1HV	7137-1	7137-3C	7137-4
High Pressure Gas	Brown	7368-1HV	7368-1	7368-3C	7368-4
High Pressure Gas	Yellow	7138-1HV	7138-1	7138-3C	7138-4
High Pressure Natural Gas	Yellow	7139-1HV	7139-1	7139-3C	7139-4
High Pressure Nitrogen	Yellow	7140-1HV	7140-1	7140-3C	7140-4
High Pressure Steam	Green	7369-1HV	7369-1	7369-3C	7369-4
High Pressure Steam	Yellow	7141-1HV	7141-1	7141-3C	7141-4
High Pressure Water	Green	7370-1HV	7370-1	7370-3C	7370-4
High Pressure Water	Yellow	7142-1HV	7142-1	7142-3C	7142-4
High Temperature Hot Water	Green	7371-1HV	7371-1	7371-3C	7371-4
High Temperature Hot Water	Yellow	7143-1HV	7143-1	7143-3C	7143-4
Hot	Green	7372-1HV	7372-1	7372-3C	7372-4
Hot	Yellow	7144-1HV	7144-1	7144-3C	7144-4
Hot Gas	Brown	7373-1HV	7373-1	7373-3C	7373-4
Hot Gas	Yellow	7145-1HV	7145-1	7145-3C	7145-4
Hot Oil	Yellow	-	131049	-	131054
Hot Water	Green	7374-1HV	7374-1	7374-3C	7374-4
Hot Water	Yellow	7146-1HV	7146-1	7146-3C	7146-4
Hot Water Recirculation	Green	7375-1HV	7375-1	7375-3C	7375-4
Hot Water Recirculation	Yellow	7147-1HV	7147-1	7147-3C	7147-4
Hot Water Return	Green	7376-1HV	7376-1	7376-3C	7376-4
Hot Water Return	Yellow	7148-1HV	7148-1	7148-3C	7148-4
Hot Water Supply	Green	7377-1HV	7377-1	7377-3C	7377-4
Hot Water Supply	Yellow	7149-1HV	7149-1	7149-3C	7149-4
House Vacuum	Blue	7378-1HV	7378-1	7378-3C	7378-4
House Vacuum	Green	7150-1HV	7150-1	7150-3C	7150-4
HVAC Return	Green	7379-1HV	7379-1	7379-3C	7379-4
HVAC Return	Yellow	7151-1HV	7151-1	7151-3C	7151-4

Pipe Markers

Self-Sticking Pipe Markers

BradyID.com/s36



Style Code	Style Example	Outside Diameter	Letter Height	Marker Size
Style: 1HV	HEATING RETURN	8 in. or greater	3.5 in.	One 4 in. x 24 in. marker per card
Style: 1	HEATING RETURN	2.5 in. to 7.875 in.	2 in.	One 2.25 in. x 14 in. marker per card
Style: 3C	HEATING RETURN	less than 0.75 in.	0.3 in.	Three 2.25 in. x 2.75 in markers per card plus 8 strips of arrow tape
Style: 4	FIRE AUTO SPRINKLERS	0.75 in. to 2.378 in.	0.75 in.	Four 1.125 in. x 7 in. markers per card*

* Use in conjunction with 1 in. arrow tape to meet the ANSI marking requirement of 8 in.

Self-Sticking Pipe Marker Legends (continued)

Legend	Color	Style 1HV	Style 1	Style 3C	Style 4
HVAC Supply	Green	7380-1HV	7380-1	7380-3C	7380-4
HVAC Supply	Yellow	7152-1HV	7152-1	7152-3C	7152-4
Hydraulic Fluid	Yellow	8789-1HV	8789-1	8789-3C	8789-4
Hydraulic Line	Yellow	7153-1HV	7153-1	7153-3C	7153-4
Hydraulic Oil	Yellow	8790-1HV	8790-1	8790-3C	8790-4
Hydraulic Return	Yellow	7154-1HV	7154-1	7154-3C	7154-4
Hydraulic Supply	Yellow	7155-1HV	7155-1	7155-3C	7155-4
Hydrochloric Acid	Orange	7381-1HV	7381-1	7381-3C	7381-4
Hydrochloric Acid	Yellow	7156-1HV	7156-1	7156-3C	7156-4
Hydrogen	Brown	7382-1HV	7382-1	7382-3C	7382-4
Hydrogen	Yellow	7157-1HV	7157-1	7157-3C	7157-4
Hydrogen Peroxide	Orange	7383-1HV	7383-1	7383-3C	7383-4
Hydrogen Peroxide	Yellow	7158-1HV	7158-1	7158-3C	7158-4
Hydrogen Sulfide	Orange	7384-1HV	7384-1	7384-3C	7384-4
Hydrogen Sulfide	Yellow	7159-1HV	7159-1	7159-3C	7159-4
Industrial Cold Water Return	Green	7160-1HV	7160-1	7160-3C	7160-4
Industrial Hot Water	Yellow	7161-1HV	7161-1	7161-3C	7161-4
Industrial Waste	Yellow	7162-1HV	7162-1	7162-3C	7162-4
Industrial Water	Green	7163-1HV	7163-1	7163-3C	7163-4
Inert Gas	Green	7164-1HV	7164-1	7164-3C	7164-4
Inert Gas	Yellow	8791-1HV	8791-1	8791-3C	8791-4
Inlet	Yellow	7165-1HV	7165-1	7165-3C	7165-4
Instrument Air	Blue	7168-1HV	7168-1	7168-3C	7168-4
Instrument Air	Green	7167-1HV	7167-1	7167-3C	7167-4
Instrument Air	Yellow	7166-1HV	7166-1	7166-3C	7166-4
Kerosene	Yellow	7169-1HV	7169-1	7169-3C	7169-4
Lab Compressed Air	Blue	7170-1HV	7170-1	7170-3C	7170-4
Lab Vacuum	Yellow	7171-1HV	7171-1	7171-3C	7171-4
Lab Vent	Yellow	8792-1HV	8792-1	8792-3C	8792-4
Lab Waste	Yellow	8793-1HV	8793-1	8793-3C	8793-4
Liquid Nitrogen	Yellow	7172-1HV	7172-1	7172-3C	7172-4
Liquor	Yellow	-	91757	-	-
Low Pressure	Green	7173-1HV	7173-1	7173-3C	7173-4
Low Pressure Air	Blue	7385-1HV	7385-1	7385-3C	7385-4
Low Pressure Air	Green	7174-1HV	7174-1	7174-3C	7174-4
Low Pressure Condensate	Green	7386-1HV	7386-1	7386-3C	7386-4
Low Pressure Condensate	Yellow	7175-1HV	7175-1	7175-3C	7175-4
Low Pressure Gas	Brown	7388-1HV	7388-1	7388-3C	7388-4
Low Pressure Gas	Yellow	7176-1HV	7176-1	7176-3C	7176-4
Low Pressure Natural Gas	Brown	7387-1HV	7387-1	7387-3C	7387-4
Low Pressure Natural Gas	Yellow	7177-1HV	7177-1	7177-3C	7177-4
Low Pressure Nitrogen	Brown	7389-1HV	7389-1	7389-3C	7389-4
Low Pressure Nitrogen	Yellow	7178-1HV	7178-1	7178-3C	7178-4
Low Pressure Steam	Green	7390-1HV	7390-1	7390-3C	7390-4
Low Pressure Steam	Yellow	7179-1HV	7179-1	7179-3C	7179-4
Low Pressure Water	Green	7180-1HV	7180-1	7180-3C	7180-4
Lube Oil	Yellow	7181-1HV	7181-1	7181-3C	7181-4
Make-Up Water	Green	7182-1HV	7182-1	7182-3C	7182-4
Medical Air	Blue	-	7183-1	7183-3C	7183-4
Medical Air	Yellow	7184-1HV	7184-1	7184-3C	7184-4
Medical Air 50-55 PSI	Yellow	-	-	86330	86331
Medical Gas	Brown	-	-	108706	108707
Medical Vacuum	Blue	7185-1HV	7185-1	7185-3C	7185-4
Medical Vacuum	White	7186-1HV	7186-1	7186-3C	7186-4
Medium Pressure Air	Blue	7187-1HV	7187-1	7187-3C	7187-4
Medium Pressure Condensate	Yellow	7188-1HV	7188-1	7188-3C	7188-4
Medium Pressure Gas	Brown	7391-1HV	7391-1	7391-3C	7391-4
Medium Pressure Gas	Yellow	7189-1HV	7189-1	7189-3C	7189-4
Medium Pressure Natural Gas	Brown	7392-1HV	7392-1	7392-3C	7392-4
Medium Pressure Natural Gas	Yellow	7190-1HV	7190-1	7190-3C	7190-4
Medium Pressure Nitrogen	Yellow	-	90261	-	-
Medium Pressure Steam	Green	7393-1HV	7393-1	7393-3C	7393-4
Medium Pressure Steam	Yellow	7191-1HV	7191-1	7191-3C	7191-4

Legend	Color	Style 1HV	Style 1	Style 3C	Style 4
Mill Air	Blue	7192-1HV	7192-1	7192-3C	7192-4
Mill Water	Green	7193-1HV	7193-1	7193-3C	7193-4
Mixed Gas	Yellow	7194-1HV	7194-1	7194-3C	7194-4
Muriatic Acid	Orange	7394-1HV	7394-1	7394-3C	7394-4
Muriatic Acid	Yellow	7195-1HV	7195-1	7195-3C	7195-4
Naphtha	Yellow	8795-1HV	8795-1	8795-3C	8795-4
Natural Gas	Brown	7395-1HV	7395-1	7395-3C	7395-4
Natural Gas	Yellow	7196-1HV	7196-1	7196-3C	7196-4
Nitric Acid	Orange	7396-1HV	7396-1	7396-3C	7396-4
Nitric Acid	Yellow	7197-1HV	7197-1	7197-3C	7197-4
Nitrogen	Black	-	-	87745	90331
Nitrogen	Blue	7200-1HV	7200-1	7200-3C	7200-4
Nitrogen	Green	7198-1HV	7198-1	7198-3C	7198-4
Nitrogen 180-200 PSI	Black	-	-	86334	-
Nitrous Oxide	Blue	-	-	87746	90333
Nitrous Oxide	Yellow	7202-1HV	7202-1	7202-3C	7202-4
Nitrous Oxide 50-55 PSI	Blue	-	-	86332	86333
No Asbestos	Blue	97597	97626	-	-
Non-Potable Water	Green	7397-1HV	7397-1	7397-3C	7397-4
Non-Potable Water	Yellow	7203-1HV	7203-1	7203-3C	7203-4
Oil	Yellow	7204-1HV	7204-1	7204-3C	7204-4
Outlet	Green	7205-1HV	7205-1	7205-3C	7205-4
Outside Air	Blue	7206-1HV	7206-1	7206-3C	7206-4
Outside Air	White	7207-1HV	7207-1	7207-3C	7207-4
Overflow	Yellow	7208-1HV	7208-1	7208-3C	7208-4
Oxygen	Blue	7211-1HV	7211-1	7211-3C	7211-4
Oxygen	Green	7210-1HV	7210-1	7210-3C	7210-4
Oxygen	Yellow	7209-1HV	7209-1	7209-3C	7209-4
Oxygen 50-55 PSI	Green	-	-	86328	86329
Peroxide	Green	7398-1HV	7398-1	7398-3C	7398-4
Peroxide	Yellow	8796-1HV	8796-1	8796-3C	8796-4
Plant Air	Blue	7399-1HV	7399-1	7399-3C	7399-4
Plant Air	Yellow	7212-1HV	7212-1	7212-3C	7212-4
Plant Water	Green	7213-1HV	7213-1	7213-3C	7213-4
Plumbing Vent	Green	7214-1HV	7214-1	7214-3C	7214-4
Polymer	White	7216-1HV	7216-1	7216-3C	7216-4
Polymer	Yellow	7215-1HV	7215-1	7215-3C	7215-4
Potable	Green	7217-1HV	7217-1	7217-3C	7217-4
Potable Water	Green	7219-1HV	7219-1	7219-3C	7219-4
Potable Water	Yellow	7218-1HV	7218-1	7218-3C	7218-4
Primary	Green	7221-1HV	7221-1	7221-3C	7221-4
Primary	Yellow	7220-1HV	7220-1	7220-3C	7220-4
Primary Sludge	Brown	7222-1HV	7222-1	7222-3C	7222-4
Process	Yellow	7223-1HV	7223-1	7223-3C	7223-4
Process Water	Green	7224-1HV	7224-1	7224-3C	7224-4
Processed Water	Green	7226-1HV	7226-1	7226-3C	7226-4
Processed Water	Yellow	7225-1HV	7225-1	7225-3C	7225-4
Propane Gas	Brown	7400-1HV	7400-1	7400-3C	7400-4
Propane Gas	Yellow	7227-1HV	7227-1	7227-3C	7227-4
Pulp	Green	7401-1HV	7401-1	7401-3C	7401-4
Pulp	Yellow	8797-1HV	8797-1	8797-3C	8797-4
Pump	Green	7402-1HV	7402-1	7402-3C	7402-4
Pump	Yellow	7228-1HV	7228-1	7228-3C	7228-4
Pumped Condensate	Green	7403-1HV	7403-1	7403-3C	7403-4
Pumped Condensate	Yellow	8799-1HV	8799-1	8799-3C	8799-4
Rain Water	Green	7229-1HV	7229-1	7229-3C	7229-4
Raw Water	Green	7230-1HV	7230-1	7230-3C	7230-4
Raw Water	Yellow	7231-1HV	7231-1	7231-3C	7231-4
Recirculated	Yellow	7232-1HV	7232-1	7232-3C	7232-4
Recovery	Yellow	7233-1HV	7233-1	7233-3C	7233-4
Red Liquor	Orange	7404-1HV	7404-1	7404-3C	7404-4
Red Liquor	Yellow	8801-1HV	8801-1	8801-3C	8801-4
Refrigerant Discharge	Yellow	7234-1HV	7234-1	7234-3C	7234-4

Pipe Markers

Self-Sticking Pipe Marker Legends (continued)

Legend	Color	Style 1HV	Style 1	Style 3C	Style 4
Refrigerant Liquid	Yellow	7235-1HV	7235-1	7235-3C	7235-4
Refrigerant Suction	Yellow	7236-1HV	7236-1	7236-3C	7236-4
Refrigerated Water	Green	7237-1HV	7237-1	7237-3C	7237-4
Refrigeration	Green	7238-1HV	7238-1	7238-3C	7238-4
Reheat Water Return	Green	7428-1HV	7428-1	7428-3C	7428-4
Reheat Water Return	Yellow	8802-1HV	8802-1	8802-3C	8802-4
Reheat Water Supply	Green	7405-1HV	7405-1	7405-3C	7405-4
Reheat Water Supply	Yellow	8803-1HV	8803-1	8803-3C	8803-4
Relief	Yellow	7239-1HV	7239-1	7239-3C	7239-4
Relief Air	Blue	7240-1HV	7240-1	7240-3C	7240-4
Ret. Activated Sludge	Yellow	7245-1HV	7245-1	7245-3C	7245-4
Return	Blue	7241-1HV	7241-1	7241-3C	7241-4
Return	Green	7242-1HV	7242-1	7242-3C	7242-4
Return	Red	7243-1HV	7243-1	7243-3C	7243-4
Return	Yellow	7244-1HV	7244-1	7244-3C	7244-4
River Water	Green	7246-1HV	7246-1	7246-3C	7246-4
Roof Drain	Green	7247-1HV	7247-1	7247-3C	7247-4
Salt Water	Green	7248-1HV	7248-1	7248-3C	7248-4
Sanitary Drain	Green	7249-1HV	7249-1	7249-3C	7249-4
Sanitary Sewer	Green	7250-1HV	7250-1	7250-3C	7250-4
Sanitary Sewer	Yellow	7251-1HV	7251-1	7251-3C	7251-4
Sanitary Vent	Yellow	7252-1HV	7252-1	7252-3C	7252-4
Sanitary Waste	Green	7406-1HV	7406-1	7406-3C	7406-4
Sanitary Waste	Yellow	7253-1HV	7253-1	7253-3C	7253-4
Seal Water	Green	7254-1HV	7254-1	7254-3C	7254-4
Secondary	Green	7255-1HV	7255-1	7255-3C	7255-4
Secondary Scum	Yellow	-	91808	-	-
Service Air	Blue	7407-1HV	7407-1	7407-3C	7407-4
Service Air	Yellow	7256-1HV	7256-1	7256-3C	7256-4
Service Water	Green	7257-1HV	7257-1	7257-3C	7257-4
Sewage	Yellow	7258-1HV	7258-1	7258-3C	7258-4
Sewer	Green	7259-1HV	7259-1	7259-3C	7259-4
Sludge	Yellow	7260-1HV	7260-1	7260-3C	7260-4
Slurry	Yellow	7261-1HV	7261-1	7261-3C	7261-4
Soap	Yellow	8804-1HV	8804-1	8804-3C	8804-4
Sodium Chlorate	Orange	7409-1HV	7409-1	7409-3C	7409-4
Sodium Chlorate	Yellow	7262-1HV	7262-1	7262-3C	7262-4
Sodium Hydrosulphide	Yellow	-	91763	-	91764
Sodium Hydroxide	Orange	7410-1HV	7410-1	7410-3C	7410-4
Sodium Hydroxide	Yellow	7263-1HV	7263-1	7263-3C	7263-4
Sodium Hypochlorite	Orange	7408-1HV	7408-1	7408-3C	7408-4
Sodium Hypochlorite	Yellow	7264-1HV	7264-1	7264-3C	7264-4
Soft Water	Green	7265-1HV	7265-1	7265-3C	7265-4
Solvent	Yellow	7266-1HV	7266-1	7266-3C	7266-4
Soot Blower Air	Yellow	-	36230	-	79936
Spent Acid	Orange	7411-1HV	7411-1	7411-3C	7411-4
Spent Acid	Yellow	8807-1HV	8807-1	8807-3C	8807-4
Sprinkler	Red	7267-1HV	7267-1	7267-3C	7267-4
Sprinkler Fire	Red	7268-1HV	7268-1	7268-3C	7268-4
Sprinkler Water	Red	7269-1HV	7269-1	7269-3C	7269-4
Steam	Green	7412-1HV	7412-1	7412-3C	7412-4
Steam	Yellow	7270-1HV	7270-1	7270-3C	7270-4
Steam Return	Green	7413-1HV	7413-1	7413-3C	7413-4
Steam Return	Yellow	7271-1HV	7271-1	7271-3C	7271-4
Steam Supply	Green	7414-1HV	7414-1	7414-3C	7414-4
Steam Supply	Yellow	7272-1HV	7272-1	7272-3C	7272-4

Spanish Legends

Legend	Color	Style 1HV	Style 1	Style 3C	Style 4
Agua	Yellow	-	-	-	83614
Agua	Green	83596	83540	83576	83615
Agua De Refrigeracion	Green	83484	83424	83460	-
Agua Fria	Green	-	83418	83453	83498
Agua Potable	Yellow	-	83522	83558	-
Agua Refrigerada	Green	83477	83414	83449	-
Agua Protec. Papa Incendios	Red	-	83430	83466	83503
Aire	Blue	-	83400	83436	-
Aire Comprimido	Yellow	-	-	83454	83499
Aire Comprimido	Blue	-	83421	83456	83501
Aire Uso Medico	Yellow	-	83514	83550	83599
Caustica	Yellow	-	83413	83448	83496
Desague Sanitario	Green	83589	83527	83563	-

Legend	Color	Style 1HV	Style 1	Style 3C	Style 4
Storm Drain	Green	7273-1HV	7273-1	7273-3C	7273-4
Storm Sewer	Green	7274-1HV	7274-1	7274-3C	7274-4
Storm Water	Green	7275-1HV	7275-1	7275-3C	7275-4
Suction	Yellow	7276-1HV	7276-1	7276-3C	7276-4
Sulfur	Orange	7415-1HV	7415-1	7415-3C	7415-4
Sulfur	Yellow	8808-1HV	8808-1	8808-3C	8808-4
Sulfur Dioxide	Orange	7417-1HV	7417-1	7417-3C	7417-4
Sulfur Dioxide	Yellow	7277-1HV	7277-1	7277-3C	7277-4
Sulfur Dioxide Liquid	Orange	7418-1HV	7418-1	7418-3C	7418-4
Sulfur Dioxide Liquid	Yellow	7278-1HV	7278-1	7278-3C	7278-4
Sulfuric Acid	Orange	7416-1HV	7416-1	7416-3C	7416-4
Sulfuric Acid	Yellow	7279-1HV	7279-1	7279-3C	7279-4
Sump Pump Discharge	Yellow	7280-1HV	7280-1	7280-3C	7280-4
Supply	Blue	7281-1HV	7281-1	7281-3C	7281-4
Supply	Green	7282-1HV	7282-1	7282-3C	7282-4
Supply	Yellow	7311-1HV	7311-1	7311-3C	7311-4
Tank Drain	Green	7419-1HV	7419-1	7419-3C	7419-4
Tank Drain	Yellow	8809-1HV	8809-1	8809-3C	8809-4
Tempered Water	Green	7420-1HV	7420-1	7420-3C	7420-4
Tempered Water	Yellow	7283-1HV	7283-1	7283-3C	7283-4
Thickened Activated Sludge	Yellow	-	90276	-	-
Toluene	Yellow	7284-1HV	7284-1	7284-3C	7284-4
Tower Water	Green	7285-1HV	7285-1	7285-3C	7285-4
Tower Water Return	Green	7286-1HV	7286-1	7286-3C	7286-4
Tower Water Supply	Green	7287-1HV	7287-1	7287-3C	7287-4
Transfer	Yellow	7288-1HV	7288-1	7288-3C	7288-4
Treated Water	Green	7289-1HV	7289-1	7289-3C	7289-4
Trichloroethylene	Yellow	-	-	92059	-
Unbleached Stock	Yellow	91783	91782	-	-
Unsafe Water	Yellow	7290-1HV	7290-1	7290-3C	7290-4
Vacuum	Green	7292-1HV	7292-1	7292-3C	7292-4
Vacuum	Yellow	7291-1HV	7291-1	7291-3C	7291-4
Valve	Yellow	7293-1HV	7293-1	7293-3C	7293-4
Vapor	Yellow	7294-1HV	7294-1	7294-3C	7294-4
Vent	Blue	7297-1HV	7297-1	7297-3C	7297-4
Vent	Green	7296-1HV	7296-1	7296-3C	7296-4
Vent	Yellow	7295-1HV	7295-1	7295-3C	7295-4
Warm Mill Water	Yellow	-	91784	-	91785
Warm Water	Green	8920-1HV	8920-1	8920-3C	8920-4
Waste	Green	7299-1HV	7299-1	7299-3C	7299-4
Waste	Yellow	7298-1HV	7298-1	7298-3C	7298-4
Waste Activated Sludge	Yellow	7300-1HV	7300-1	7300-3C	7300-4
Waste Water	Green	7301-1HV	7301-1	7301-3C	7301-4
Waste Water	Yellow	7302-1HV	7302-1	7302-3C	7302-4
Water	Green	7304-1HV	7304-1	7304-3C	7304-4
Water	Yellow	7303-1HV	7303-1	7303-3C	7303-4
Weak Black Liquor	Orange	7424-1HV	7424-1	7424-3C	7424-4
Weak Black Liquor	Yellow	8921-1HV	8921-1	8921-3C	8921-4
Weak Caustic Liquor	Yellow	-	91793	-	-
Weak White Liquor	Orange	7425-1HV	7425-1	7425-3C	7425-4
Weak White Liquor	Yellow	8922-1HV	8922-1	8922-3C	8922-4
Well Water	Green	7305-1HV	7305-1	7305-3C	7305-4
White Liquor	Orange	7423-1HV	7423-1	7423-3C	7423-4
White Liquor	Yellow	8923-1HV	8923-1	8923-3C	8923-4
White Water	Yellow	7306-1HV	7306-1	7306-3C	7306-4

Legend	Color	Style 1HV	Style 1	Style 3C	Style 4
Gas	Yellow	83489	83432	83468	83505
Gas Natural	Yellow	83585	83517	83553	83601
Hidrogeno	Yellow	-	83510	83545	83598
Nitrogeno	Green	-	83518	-	83554
Oxigeno	Green	-	83520	83556	83604
Respiradero	Yellow	-	83537	83573	83612
Retorno	Yellow	-	-	-	83561
Retorno De Agua Refrigerada	Green	83478	83415	83450	-
Suministro Agua Refrigerada	Green	83479	83416	83451	-
Vacio Uso Medico	White	-	83515	83551	83600
Vacio Uso Medico	Yellow	83583	-	-	83571
Vapor	Yellow	83590	83530	83566	83607

Self-Sticking Pipe Markers

BradyID.com/s36

Roll-Form Pipe Markers

- Eliminates need for precise measurement of pipe diameter
Simply cut to the size you need from the 30 foot long roll
- B-946 material adheres to itself for easy wrap-around marker installation
- 8 in. wide roll repeats legend 65 times per roll
12 in. wide roll repeats legend 29 times per roll



Legend	Color	8 in. x 30 ft.	12 in. x 30 ft.
(Blank)	Blue	41598	15507
(Blank)	Clear	41594	15504
(Blank)	Green	41597	-
(Blank)	Red	41599	15508
(Blank)	Yellow	41596	-
(Blank)	Yellow	41532	15509
___ LB Steam	Yellow	41483	15600
___ LB. Steam	Green	109926	109927
Acid	Orange	108442	108443
Acid	Yellow	41538	15500
Alum	Yellow	41539	15501
Asbestos Free	Blue	41593	15502
Black Liquor	Orange	108503	108504
Black Liquor	Yellow	41523	15503
Bleach Stock	Yellow	52643	52644
Bleached Liquor	Orange	108520	108521
Bleached Liquor	Yellow	52641	52642
Boiler Feed Water	Green	108609	108610
Boiler Feed Water	Yellow	41537	15512
Caustic	Orange	108724	108725
Caustic	Yellow	41545	15515
Caustic Soda	Orange	108744	108745
Caustic Soda	Yellow	41535	15516
Chilled Water	Green	41518	15517
Chlorine	Orange	108780	108781
Chlorine	Yellow	41530	15518
Chlorine Gas	Brown	108798	108799
Chlorine Gas	Yellow	41549	15520
Circulating Water	Green	41551	15521
City Water	Green	41522	15522
Cold Water	Green	41512	15523
Compressed Air	Blue	41456	15536
Compressed Air	Yellow	41455	15535
Condensate	Yellow	41521	15524
Contains Asbestos	Blue	108863	108864
Contains Asbestos	Yellow	52665	81728
Cooling Water	Green	41457	15537
Danger Asbestos Insulation	Blue	108872	108873
Danger Asbestos Insulation	Yellow	41592	15526
Danger Contains Asbestos Fibers	Blue	108874	108875
Danger Contains Asbestos Fibers	Yellow	41595	15527
Demin. Water	Blue	52673	52674
Demin. Water	Green	108880	108881
Domestic Cold Water	Green	41458	15538
Domestic Hot Water	Green	108897	108898
Domestic Hot Water	Yellow	41459	15539
Drain	Green	41460	15540
Filtered Water	Green	41554	15530
Fire Auto Sprinklers	Red	41461	15541
Fire Protection Water	Red	41462	15542
Fresh Water	Green	41555	15532
Fuel Oil	Yellow	41463	15543
Gas	Brown	109002	109003
Gas	Yellow	41464	15544
Green Liquor	Orange	109032	109033
Green Liquor	Yellow	41527	15533
High Pressure Steam	Green	109152	109153
High Pressure Steam	Yellow	41519	15534
Hot Water	Green	109219	109220
Hot Water	Yellow	41510	15545
Hot Water Return	Green	109250	109251
Hot Water Return	Yellow	41465	15582
Hot Water Supply	Green	109273	109274

Legend	Color	8 in. x 30 ft.	12 in. x 30 ft.
Hot Water Supply	Yellow	41466	15583
Hydrochloric Acid	Orange	109308	109309
Hydrochloric Acid	Yellow	41557	15546
Hydrogen	Brown	109326	109327
Hydrogen	Yellow	41467	15584
Hydrogen Peroxide	Orange	109344	109345
Hydrogen Peroxide	Yellow	41558	15547
Hydrogen Sulfide	Orange	109350	109351
Hydrogen Sulfide	Yellow	41559	15548
Industrial Water	Green	41468	15585
Lime Mud	Orange	109360	109361
Lime Mud	Yellow	41560	15549
Low Pressure Steam	Green	109440	109441
Low Pressure Steam	Yellow	41520	15550
Make-Up Water	Green	41562	15552
Mill Air	Blue	41563	15553
Mill Water	Green	41564	15554
Natural Gas	Brown	109488	109489
Natural Gas	Yellow	41511	15556
Noncondensable Gas	Yellow	41565	15555
Oxygen	Blue	41470	15587
Oxygen	Yellow	41469	15586
Plant Air	Blue	109560	109561
Plant Air	Yellow	41471	15588
Pond Water	Green	41567	15557
Potable Water	Green	41472	15589
Process Water	Green	41568	15558
Raw Water	Green	41570	15560
Return	Green	41515	15562
Return	Yellow	41514	15561
Roof Drain	Green	41473	15590
Sanitary Sewer	Yellow	41474	15591
Seal Water	Green	41572	15563
Sodium Hypochlorite	Orange	109681	109682
Sodium Hypochlorite	Yellow	41575	15566
Sprinkler Fire	Red	41475	15592
Sprinkler Water	Red	41476	15593
Steam	Green	109725	109726
Steam	Yellow	41513	15567
Storm Drain	Green	41477	15594
Sulfur Dioxide	Orange	109802	109803
Sulfur Dioxide	Yellow	41579	15569
Sulfuric Acid	Orange	109785	109786
Sulfuric Acid	Yellow	41536	15570
Supply	Green	41517	15572
Supply	Yellow	41516	15571
Tower Water	Green	41478	15595
Treated Water	Green	41582	15573
Vacuum	Yellow	41479	15596
Vent	Blue	109845	109846
Vent	Yellow	41480	15597
Warm Mill Water	Yellow	41584	15574
Waste Water	Green	109865	109866
Waste Water	Yellow	41586	15576
Water	Green	41482	15599
Water	Yellow	41481	15598
Weak Wash	Orange	109894	109895
Weak Wash	Yellow	41589	15578
White Liquor	Orange	109888	109889
White Liquor	Yellow	41524	15580
White Water	Yellow	41525	15581

Self-Sticking Pipe Markers

BradyID.com/s36



Pipe Markers-To-Go

- Made of economical B-736 surface printed plastic for use on smooth, clean, dry pipe surfaces
- Markers withstand temperatures from -40° F to 212° F
- Supplied in as roll of 25 identical markers and arrows
- Arrows are perforated and may be applied to indicate flow in either direction
- Ideal for on-the-spot repair or replacement of damaged or missing markers

Pipe Markers

Legend	Color	1 in. x 8 in. (25/roll)	2 in. x 12 in. (25/roll)
(Blank)	Yellow	20483	73944
(Blank)	Green	20484	73945
(Blank)	Blue	20485	73946
(Blank)	Red	20486	73947
Acid	Yellow	20400	73860
Acid	Orange	108444	108445
Air	Blue	20401	73861
Arrow	Yellow	20487	73948
Arrow	Green	20488	73949
Arrow	Blue	20489	73950
Arrow	Red	20490	73951
Asbestos Free Insulation	Blue	20402	73862
Boiler Blowdown	Green	108585	108586
Boiler Blowdown	Yellow	20403	73863
Boiler Feed Water	Yellow	20404	73864
Boiler Feed Water	Green	108611	108612
Carbon Dioxide	Yellow	20405	73865
Carbon Dioxide	Brown	108699	108700
Caustic	Yellow	20406	73866
Caustic	Orange	108726	108727
Chilled Water	Green	20407	73867
Chilled Water Return	Green	20408	73868
Chilled Water Supply	Green	20409	73869
Circulating Water	Green	20410	73870
City Water	Green	20411	73871
Cold Water	Green	20412	73872
Cold Water Return	Green	20413	73873
Cold Water Supply	Green	20414	73874
Compressed Air	Blue	20415	73875
Compressed Air	Yellow	20416	73877
Condensate	Yellow	20417	73878
Condensate Return	Yellow	20418	73879
Condensate Return	Green	108857	108858
Condensate Supply	Yellow	20419	73880
Condenser Water Return	Green	20421	73882
Condenser Water Supply	Green	20422	73883
Cooling Water	Green	20424	73885
Domestic Cold Water	Green	20425	73886
Domestic Hot Water	Yellow	20426	73887
Domestic Hot Water	Green	108899	108900
Drain	Green	20427	73888
Exhaust	Yellow	20428	73889
Exhaust	Blue	108950	108951
Filtered Water	Green	20429	73890
Fire Protection Water	Red	20430	73891
Fuel Oil	Yellow	20431	73892
Gas	Yellow	20432	73893
Gas	Brown	109004	109005
Glycol	Yellow	20433	73894
Glycol	Brown	110235	110236
Heating	Yellow	20434	73895
Heating	Green	109038	109039
Heating Return	Yellow	20435	73896
Heating Return	Green	109055	109056
Heating Supply	Yellow	20436	73897
Heating Supply	Green	109072	109073
High Pressure Air	Yellow	20437	73898
High Pressure Air	Blue	109124	109125
High Pressure Condensate	Yellow	20438	73899
High Pressure Condensate	Green	109182	109183

Legend	Color	1 in. x 8 in. (25/roll)	2 in. x 12 in. (25/roll)
High Pressure Steam	Yellow	20439	73900
High Pressure Steam	Green	109154	109155
Hot Water	Yellow	20440	73901
Hot Water	Green	109221	109222
Hot Water Return	Yellow	20441	73902
Hot Water Return	Green	109252	109253
Hot Water Supply	Yellow	20442	73903
Hot Water Supply	Green	109275	109276
Low Pressure Air	Blue	20443	73904
Low Pressure Air	Blue	109373	109374
Low Pressure Condensate	Yellow	20444	73905
Low Pressure Condensate	Green	109390	109391
Low Pressure Steam	Yellow	20445	73906
Low Pressure Steam	Green	109442	109443
Make-Up Water	Green	20446	73907
Medium Pressure Air	Blue	20447	73908
Medium Pressure Steam	Yellow	20448	73909
Medium Pressure Steam	Green	109467	109468
Natural Gas	Yellow	20449	73910
Natural Gas	Brown	109490	109491
Nitrogen	Green	20450	73911
Non-Potable Water	Yellow	20452	73913
Non-Potable Water	Green	109527	109528
Oil	Yellow	20453	73914
Oxygen	Yellow	20454	73915
Plant Air	Yellow	20455	73916
Plant Air	Blue	109562	109563
Potable Water	Green	20456	73917
Propane Gas	Yellow	20457	73918
Propane Gas	Brown	109579	109580
Raw Water	Green	20458	73919
Refrigerated Liquid	Yellow	20459	73920
Refrigerated Suction	Yellow	20460	73921
Return	Green	20461	73922
Return	Yellow	20462	73923
Roof Drain	Green	20463	73924
Sanitary Drain	Green	20464	73925
Sanitary Sewer	Green	20465	73926
Sprinkler Fire	Red	20466	73927
Sprinkler Water	Red	20467	73928
Steam	Yellow	20468	73929
Steam	Green	109727	109728
Steam Return	Yellow	20469	73930
Steam Return	Green	109740	109741
Steam Supply	Yellow	20470	73931
Steam Supply	Green	109753	109754
Storm Drain	Blue	20471	73932
Supply	Green	20472	73933
Supply	Yellow	20473	73934
Tower Water	Green	20474	73935
Vacuum	Green	20475	73936
Vacuum	Yellow	20476	73937
Vent	Green	20477	73938
Vent	Yellow	20478	73939
Vent	Blue	109847	109848
Waste	Yellow	20479	73940
Waste Water	Green	20480	73941
Water	Green	20481	73942
Water	Yellow	20482	73943

Self-Sticking Pipe Markers

BradyID.com/s36



Semiconductor and Chemical Pipe Markers

- B-946 self-sticking vinyl with permanent adhesive
- For use on small diameter piping or tubing 0.75 in. or less
- Meets ASME A13.1 color specifications

Legend	Color	0.5 in. x 2.25 in. (28/card)
(Arrow)	Yellow	91883
(Arrow)	Green	91884
(Arrow)	Red	91885
(Arrow)	Blue	91886
(Arrow)	Orange	91887
(Arrow)	White	91888
(Blank)	Yellow	91889
(Blank)	Green	91890
(Blank)	Red	91891
(Blank)	Blue	91892
(Blank)	Orange	91893
(Blank)	White	91894
Acetone	Yellow	91895
Acid	Orange	108446
Acid	Yellow	91896
Acid Waste	Orange	108455
Acid Waste	Yellow	91897
Air	Green	91898
Ammonia	Orange	108471
Ammonia	Yellow	91899
Argon	Brown	108483
Argon	Yellow	91900
Argon	Green	91901
Carbon Dioxide	Brown	108708
Carbon Dioxide	Yellow	91906
Carbon Dioxide	Green	91907
Caustic	Orange	108728
Caustic	Green	91909
Chilled Water	Green	91910

Legend	Color	0.5 in. x 2.25 in. (28/card)
Chlorine	Orange	108782
Chlorine	Yellow	91911
City Water	Green	91913
Clean Dry Air	Yellow	91914
Clean Dry Air	Green	91915
Cold Water	Green	91916
Compressed Air	Blue	91917
Cooling Water	Green	91918
D.I. Water	Green	91920
Deionized Water	Green	91921
Do Not Paint	Red	150685
Drain	Yellow	91925
Drain	Green	91926
Exhaust	Blue	108952
Exhaust	Yellow	91930
Heating Water	Green	109078
Heating Water	Yellow	91933
Helium	Yellow	91934
Helium	Green	91935
Hot	Green	109199
Hot	Yellow	91936
Hot Water	Green	109223
Hot Water	Yellow	91937
Hydrochloric Acid	Orange	109310
Hydrochloric Acid	Yellow	91938
Hydrofluoric Acid	Yellow	91939
Hydrogen	Brown	109328
Hydrogen	Yellow	91940
Hydrogen Chloride	Yellow	91942

Legend	Color	0.5 in. x 2.25 in. (28/card)
Industrial Water	Green	91943
Isopropyl Alcohol	Yellow	91944
Methyl Alcohol	Yellow	91948
Natural Gas	Brown	109496
Natural Gas	Yellow	91949
Nitrogen	Blue	91997
Nitrogen	Green	91998
Nitrogen Trifluoride	Yellow	91950
Nitrous Oxide	Yellow	91951
Non-Potable Water	Green	109529
Non-Potable Water	Yellow	91953
Oxygen	Yellow	91955
Phosphine	Yellow	91956
Potable Water	Green	91958
Process Cooling Water	Green	91959
Process Vacuum	Green	91961
Return	Yellow	91964
Return	Green	91965
Silane	Yellow	91966
Solvent	Yellow	91967
Spare	Green	91968
Supply	Yellow	91972
Trichlorosilane	Yellow	91974
Vacuum	Green	91977
Vent	Blue	109849
Vent	Yellow	91978
Vent	Green	91979
Water	Green	91981



Medical Gas Pipe Markers-on-a-Roll

- 3 in. x 3 in. markers wrap completely around 0.75 in. pipe
- Includes direction flow arrows with 0.25 in. high characters
- Complies with CGA and NFPA Standards

Catalog #	Legend	Color	Roll Length	Qty.
98499	Cyclopropane	Black on Orange	15 ft.	60/roll
98621	Helium	White on Brown	15 ft.	60/roll
98838	Medical Vacuum	Black on White	15 ft.	60/roll
98844	Oxygen	White on Green	15 ft.	60/roll



Duct Markers

- B-946 self-sticking vinyl markers make it easy to color-code between different air systems
- Detachable arrows can be applied in any direction

Legend	Color	2.25 in. x 13.25 in.	4.0 in. x 20.5 in.
Exhaust	Yellow	98356	98490
Exhaust Air	Yellow	98357	98491
Intake	Yellow	98358	98492
Outside Air	Blue	98368	98493
Relief	Yellow	98378	98494
Relief Air	Blue	98487	98495
Return Air	Blue	98488	98496
Supply Air	Blue	98489	98497

BradySnap-On™ / Strap-On Pipe Markers

BradyID.com/s36



BradySnap-On Pipe Markers

- Designed for pipes that have an outside diameter between 0.75 in. and 6 in. (including insulation)
- Coiled plastic marker snaps around pipe and can be removed and re-applied
- May be applied to dirty, oily, greasy or rough surfaces
- Meet ASME (ANSI) Standard

BradySnap-On Marker Styles and Sizes

Style Code	Outside Diameter	Letter Height	Marker Length
Style: A	0.75 in. to 1.375 in.	0.5 in.	8 in.
Style: B	1.5 in. to 2.375 in.	0.75 in.	9 in.
Style: C	2.5 in. to 3.875 in.	1.25 in.	13 in.
Style: D	4 in. to 6 in.	1.25 in.	21 in.



Strap-On Pipe Markers

- Designed for pipes that have a 6 in. or larger diameter (including insulation)
- May be applied to dirty, oily, greasy or rough surfaces
- Can be removed and reapplied in other areas
- Styles F, G and H include nylon straps

Strap-On Marker Styles and Sizes

Style Code	Outside Diameter	Letter Height	Marker Size
Style: F	6 in. to 7.875 in.	1.25 in.	8 in. x 16 in.
Style: G	8 in. to 9.875 in.	2.5 in.	10 in. x 24 in.
Style: H	10 in. to 15 in.	3.5 in.	10 in. x 32 in.

How to order:

1. Choose the desired pipe marker legend below.
2. Replace the asterisk (*) with the style code (A, B, C, D, F, G or H) from the size charts above to indicate your desired pipe marker size and style. (Example: Air = 4001-H)

Pipe Markers

BradySnap-On and Strap-On Marker Legends

Legend	Color	Cat. #
(Blank)	Blue	4013-*
(Blank)	Green	4011-*
(Blank)	Red	4012-*
(Blank)	Yellow	4010-*
Acetone	Yellow	4157-*
Acetylene Gas	Brown	4288-*
Acetylene Gas	Yellow	4158-*
Acid	Orange	4289-*
Acid	Yellow	4000-*
Air	Blue	4002-*
Air	Green	4001-*
Air	Yellow	4003-*
Air Supply	Blue	4160-*
Alum	Yellow	4004-*
Ammonia	Orange	4290-*
Ammonia	Yellow	4005-*
Argon	Blue	4162-*
Argon	Brown	4291-*
Argon	Green	4006-*
Asbestos Free	Blue	4007-*
Asbestos Free Insulation	Blue	4008-*
Asbestos Insulation	Blue	4315-*
Asbestos Insulation	Yellow	4009-*
Black Liquor	Orange	4292-*
Bleach Liquor	Orange	4293-*
Blow Off Water	Yellow	4284-*
Blowdown	Green	4294-*
Blowdown	Yellow	4014-*
Blower Air	Blue	4296-*
Blower Air	Green	4165-*

Legend	Color	Cat. #
Blower Air	Red	4297-*
Boiler Blowdown	Green	4298-*
Boiler Blowdown	Yellow	4015-*
Boiler Drain	Green	4299-*
Boiler Feed	Yellow	4016-*
Boiler Feed Water	Green	4300-*
Boiler Feed Water	Yellow	4017-*
Breathing Air	Blue	4302-*
Breathing Air	Green	4167-*
Breathing Air	Red	4303-*
Brine	Green	4018-*
Brine	Orange	4304-*
Carbon Dioxide	Brown	4306-*
Carbon Dioxide	Yellow	4019-*
Carbon Dioxide	Yellow	4168-*
Caustic	Orange	4307-*
Caustic	Yellow	4020-*
Caustic Soda	Orange	4308-*
Caustic Soda	Yellow	4021-*
Chemical	Orange	4309-*
Chemical	Yellow	4169-*
Chilled Water	Green	4022-*
Chilled Water Return	Green	4023-*
Chilled Water Supply	Green	4024-*
Chlorine	Orange	4310-*
Chlorine	Yellow	4025-*
Chlorine Gas	Brown	4311-*
Chlorine Gas	Yellow	4026-*
Circulating Water	Green	4170-*
City Gas	Brown	4312-*

Legend	Color	Cat. #
City Gas	Yellow	4027-*
City Water	Green	4028-*
Cold Water	Green	4029-*
Cold Water Return	Green	4030-*
Cold Water Supply	Green	4031-*
Compressed Air	Blue	4034-*
Compressed Air	Green	4033-*
Compressed Air	Yellow	4032-*
Condensate	Brown	4313-*
Condensate	Yellow	4035-*
Condensate Drain	Yellow	4036-*
Condensate Return	Green	4314-*
Condensate Return	Yellow	4037-*
Condensate Supply	Yellow	4038-*
Condenser Water	Green	4039-*
Condenser Water Return	Green	4040-*
Condenser Water Supply	Green	4041-*
Cooling Water	Green	4042-*
Cooling Water Return	Green	4043-*
Cooling Water Supply	Green	4044-*
Danger Asbestos Insulation	Yellow	4045-*
Deionized Water	Green	4046-*
Deionized Water Return	Green	4172-*
Deionized Water Supply	Green	4173-*
Diesel Oil	Yellow	4174-*
Discharge	Green	4175-*
Distilled Water	Green	4047-*
Domestic Cold Water	Green	4048-*
Domestic Cold Water Return	Green	4049-*
Domestic Cold Water Supply	Green	4050-*

BradySnap-On and Strap-On Marker Legends (continued)

Legend	Color	Cat. #
Domestic Hot Water	Green	4316-*
Domestic Hot Water	Yellow	4051-*
Domestic Hot Water Return	Green	4317-*
Domestic Hot Water Return	Yellow	4052-*
Domestic Hot Water Supply	Green	4318-*
Domestic Hot Water Supply	Yellow	4053-*
Drain	Green	4055-*
Drain	Yellow	4054-*
Drain Water	Green	4176-*
Drinking Water	Green	4056-*
Dye	Yellow	4177-*
Effluent	Yellow	4178-*
Electric Traced	Yellow	4179-*
Engine Oil	Yellow	4180-*
Exhaust	Blue	4319-*
Exhaust	Yellow	4057-*
Exhaust Air	Blue	4181-*
Filtered Water	Green	4058-*
Filtrate	Green	4320-*
Filtrate	Yellow	4184-*
Fire Auto Sprinklers	Red	4059-*
Fire Main	Red	4185-*
Fire Protection Water	Red	4060-*
Floor Drain	Green	4285-*
Freon	Green	4061-*
Fresh Water	Green	4186-*
Fuel Gas	Brown	4321-*
Fuel Gas	Yellow	4062-*
Fuel Oil	Yellow	4063-*
Fuel Oil Return	Yellow	4064-*
Fuel Oil Supply	Yellow	4065-*
Fuel Oil Vent	Yellow	4066-*
Gas	Blue	4187-*
Gas	Brown	4322-*
Gas	Yellow	4067-*
Gasoline	Brown	4323-*
Glycol	Brown	4200-*
Glycol	Yellow	4068-*
Glycol Return	Brown	4201-*
Glycol Return	Yellow	4189-*
Glycol Supply	Brown	4202-*
Glycol Supply	Yellow	4190-*
Green Liquor	Orange	4324-*
Heating Return	Green	4325-*
Heating Return	Yellow	4070-*
Heating Supply	Green	4326-*
Heating Supply	Yellow	4071-*
Heating Water Return	Green	4327-*
Heating Water Return	Yellow	4072-*
Heating Water Supply	Green	4328-*
Heating Water Supply	Yellow	4073-*
Helium	Green	4074-*
High Pressure Air	Blue	4329-*
High Pressure Air	Yellow	4075-*
High Pressure Condensate	Green	4333-*
High Pressure Condensate	Yellow	4076-*
High Pressure Gas	Brown	4330-*
High Pressure Gas	Yellow	4193-*
High Pressure Natural Gas	Yellow	4194-*
High Pressure Nitrogen	Yellow	4195-*
High Pressure Steam	Green	4331-*
High Pressure Steam	Yellow	4077-*
High Pressure Water	Green	4332-*
High Pressure Water	Yellow	4078-*
Hot	Green	4334-*
Hot	Yellow	4197-*
Hot Water	Green	4335-*
Hot Water	Yellow	4079-*
Hot Water Recirculation	Green	4336-*
Hot Water Recirculation	Yellow	4080-*
Hot Water Return	Green	4337-*
Hot Water Return	Yellow	4081-*
Hot Water Supply	Green	4338-*
Hot Water Supply	Yellow	4082-*
Hydraulic Fluid	Yellow	4198-*

Legend	Color	Cat. #
Hydraulic Line	Yellow	4083-*
Hydraulic Oil	Yellow	4199-*
Hydraulic Supply	Yellow	4084-*
Hydrochloric Acid	Orange	4339-*
Hydrochloric Acid	Yellow	4085-*
Hydrogen	Brown	4340-*
Hydrogen	Yellow	4086-*
Hydrogen Peroxide	Orange	4341-*
Hydrogen Peroxide	Yellow	4087-*
Industrial Water	Green	4088-*
Instrument Air	Blue	4089-*
Instrument Air	Blue	4223-*
Instrument Air	Green	4287-*
Instrument Air	Green	4287-*
Instrument Air	Green	4287-*
Instrument Air	Green	4287-*
Instrument Air	Yellow	4222-*
Lab Vent	Yellow	4225-*
Lab Waste	Yellow	4226-*
Liquid Nitrogen	Yellow	4227-*
Low Pressure	Green	4228-*
Low Pressure Air	Blue	4342-*
Low Pressure Air	Green	4229-*
Low Pressure Air	Yellow	4090-*
Low Pressure Condensate	Green	4343-*
Low Pressure Condensate	Yellow	4091-*
Low Pressure Gas	Brown	4345-*
Low Pressure Gas	Yellow	4240-*
Low Pressure Natural Gas	Brown	4344-*
Low Pressure Natural Gas	Yellow	4241-*
Low Pressure Nitrogen	Brown	4346-*
Low Pressure Steam	Green	4347-*
Low Pressure Steam	Yellow	4092-*
Low Pressure Water	Green	4243-*
Lube Oil	Yellow	4244-*
Make-Up Water	Green	4093-*
Med. Pressure Condensate	Yellow	4094-*
Medical Air	Blue	4096-*
Medium Pressure Steam	Green	4348-*
Medium Pressure Steam	Yellow	4095-*
Mixed Gas	Yellow	4245-*
Natural Gas	Brown	4349-*
Natural Gas	Yellow	4097-*
Nitric Acid	Orange	4350-*
Nitric Acid	Yellow	4247-*
Nitrogen	Blue	4100-*
Nitrogen	Green	4099-*
Nitrogen	Yellow	4098-*
Nitrous Oxide	Yellow	4101-*
Non-Potable Water	Green	4351-*
Non-Potable Water	Yellow	4102-*
Oil	Yellow	4103-*
Outside Air	Blue	4248-*
Overflow	Yellow	4104-*
Oxygen	Blue	4107-*
Oxygen	Green	4106-*
Oxygen	Yellow	4105-*
Peroxide	Green	4352-*
Peroxide	Yellow	4249-*
Plant Air	Blue	4353-*
Plant Air	Yellow	4108-*
Plant Water	Green	4109-*
Plumbing Vent	Green	4110-*
Polymer	Yellow	4260-*
Potable	Green	4261-*
Potable Water	Green	4111-*
Process Water	Green	4113-*
Process Water	Yellow	4112-*
Propane Gas	Brown	4354-*
Propane Gas	Yellow	4114-*
Pulp	Green	4355-*
Pump	Green	4356-*
Pumped Condensate	Green	4357-*
Pumped Condensate	Yellow	4264-*
Rain Water	Green	4115-*

Legend	Color	Cat. #
Raw Water	Green	4116-*
Red Liquor	Orange	4358-*
Refrigerant Liquid	Yellow	4117-*
Refrigerant Suction	Yellow	4118-*
Reheat Water Return	Green	4359-*
Reheat Water Return	Yellow	4266-*
Reheat Water Supply	Green	4360-*
Reheat Water Supply	Yellow	4267-*
Return	Green	4120-*
Return	Yellow	4119-*
Roof Drain	Green	4121-*
Sanitary Drain	Green	4122-*
Sanitary Sewer	Green	4123-*
Service Air	Blue	4361-*
Service Air	Yellow	4269-*
Service Water	Green	4270-*
Sewage	Yellow	4271-*
Sewer	Green	4272-*
Sludge	Yellow	4273-*
Soap	Yellow	4274-*
Sodium Hydroxide	Orange	4363-*
Sodium Hydroxide	Yellow	4275-*
Sodium Hypochlorite	Orange	4362-*
Sodium Hypochlorite	Yellow	4124-*
Soft Water	Green	4125-*
Spent Acid	Orange	4364-*
Sprinkler	Red	4277-*
Sprinkler Fire	Red	4127-*
Sprinkler Water	Red	4128-*
Steam	Yellow	4129-*
Steam Return	Green	4365-*
Steam Return	Yellow	4130-*
Steam Supply	Green	4366-*
Steam Supply	Yellow	4131-*
Storm Drain	Green	4132-*
Storm Sewer	Green	4133-*
Storm Water	Green	4134-*
Sulfur	Orange	4367-*
Sulfur Dioxide	Orange	4369-*
Sulfur Dioxide	Yellow	4135-*
Sulfuric Acid	Orange	4368-*
Sulfuric Acid	Yellow	4136-*
Sump Pump Discharge	Yellow	4137-*
Supply	Green	4139-*
Supply	Yellow	4138-*
Tank Drain	Green	4370-*
Tank Drain	Yellow	4279-*
Tempered Water	Green	4371-*
Tempered Water	Yellow	4140-*
Toluene	Yellow	4141-*
Tower Water	Green	4142-*
Tower Water Return	Green	4143-*
Tower Water Supply	Green	4144-*
Treated Water	Green	4145-*
Vacuum	Green	4147-*
Vacuum	Yellow	4146-*
Vent	Blue	4149-*
Vent	Green	4150-*
Vent	Yellow	4148-*
Waste	Yellow	4151-*
Waste Water	Green	4153-*
Waste Water	Yellow	4152-*
Water	Green	4155-*
Water	Yellow	4154-*
Weak Black Liquor	Orange	4375-*
Weak Black Liquor	Yellow	4281-*
Weak White Liquor	Orange	4376-*
Well Water	Green	4156-*
White Liquor	Orange	4374-*
White Liquor	Yellow	4283-*

High-Performance Pipe Markers

BradyID.com/s36



Adhesive lip seals marker to itself during installation



B-689 Wrap-Around High Performance Pipe Markers

- PVF overlaminated polyester construction seals in and protects graphics
- Markers resist abrasion, chemicals, high humidity and outdoor weathering
- Pre-coiled for easy wrap-around installation on pipe up to 7.875 in. diameter

Wrap-Around Marker Styles and Sizes

Style Code	Outside Dia.	Letter Height	Marker Size
Style: 0	0.5 in. to 1.375 in.	0.5 in.	8 in. x 5 in. (uncoiled)
Style: I	1.5 in. to 2.378 in.	0.75 in.	9 in. x 8 in. (uncoiled)
Style: II	2.5 in. to 7.875 in.	1.25 in.	26 in. x 12 in. (uncoiled)

B-681 / B-883 HPHV High Performance, High Visibility Markers

- Ideal for pipes 8 in. and larger in diameter
- Overlaminated graphics are factory applied to a fiberglass plastic carrier
- Easy strap-on installation of fiberglass plastic carrier
- Includes two heavy-duty mounting clips that apply to pipe using continuous stainless steel strapping (sold separately)

HPHV Marker Style and Size Chart

Style Code	Outside Dia.	Letter Height	Marker Size
Style: HPHV	8 in. or larger	3.5 in.	4 in. x 24 in.

Spare carriers, mounting clips and steel strapping available on page 359.

Pipe Markers

High Performance Marker Legends

Legend	Color	Style 0	Style I	Style II	Style HPHV
(Blank Carrier)	White	-	-	-	59918
(Blank)	Blue	5600-O	5600-I	5600-II	-
(Blank)	Green	5601-O	5601-I	5601-II	-
(Blank)	Red	5602-O	5602-I	5602-II	-
(Blank)	Yellow	5603-O	5603-I	5603-II	-
120# Steam	Yellow	5613-O	5613-I	5613-II	5613-HPHV
150# Steam	Yellow	5614-O	5614-I	5614-II	-
2# Fuel Oil	Yellow	5693-O	5693-I	5693-II	5693-HPHV
200# Steam	Yellow	5617-O	5617-I	5617-II	5617-HPHV
35# Steam	Yellow	5607-O	5607-I	5607-II	-
400# Steam	Yellow	5619-O	5619-I	5619-II	-
6# Fuel Oil	Yellow	5694-O	5694-I	5694-II	5694-HPHV
60# Steam	Yellow	5609-O	5609-I	5609-II	-
Abandoned	Yellow	5622-O	5622-I	5622-II	5622-HPHV
Acid	Orange	5796-O	5796-I	5796-II	5796-HPHV
Acid	Yellow	5624-O	5624-I	5624-II	5624-HPHV
Air	Blue	5625-O	5625-I	5625-II	-
Ammonia	Orange	5797-O	5797-I	5797-II	5797-HPHV
Anhydrous	Yellow	5631-O	5631-I	5631-II	5631-HPHV
Anhydrous Ammonia	Yellow	5631-O	5631-I	5631-II	5631-HPHV
Asbestos Free Insulation	Blue	5632-O	5632-I	5632-II	5632-HPHV
Black Liquor	Orange	5798-O	5798-I	5798-II	5798-HPHV
Black Liquor	Yellow	5634-O	5634-I	5634-II	5634-HPHV
Bleached Stock	Orange	5799-O	5799-I	5799-II	5799-HPHV
Boiler Blowdown	Green	5800-O	5800-I	5800-II	5800-HPHV
Boiler Blowdown	Yellow	5636-O	5636-I	5636-II	5636-HPHV
Boiler Blowdown	Yellow	5636-O	5636-I	5636-II	5636-HPHV
Boiler Feed Water	Green	5801-O	5801-I	5801-II	5801-HPHV
Boiler Feed Water	Yellow	5637-O	5637-I	5637-II	5637-HPHV
BOP Control	Yellow	-	-	131058	-
Broke Stock	Green	5804-O	5804-I	5804-II	5804-HPHV
Brine	Orange	5802-O	5802-I	5802-II	5802-HPHV
Carbon Dioxide	Brown	5805-O	5805-I	5805-II	5805-HPHV
Caustic	Orange	5806-O	5806-I	5806-II	5806-HPHV

Legend	Color	Style 0	Style I	Style II	Style HPHV
Caustic	Yellow	5643-O	5643-I	5643-II	5643-HPHV
Caustic Soda	Orange	5807-O	5807-I	5807-II	5807-HPHV
Chemical Feed	Orange	5808-O	5808-I	5808-II	5808-HPHV
Chemical Feed	Yellow	5645-O	5645-I	5645-II	5645-HPHV
Chilled Water	Green	5646-O	5646-I	5646-II	-
Chilled Water Return	Green	5647-O	5647-I	5647-II	5647-HPHV
Chilled Water Supply	Green	5648-O	5648-I	5648-II	5648-HPHV
Chlorine	Orange	5809-O	5809-I	5809-II	5809-HPHV
Chlorine Dioxide Gas	Brown	5811-O	5811-I	5811-II	5811-HPHV
Chlorine Dioxide Liquid	Brown	5812-O	5812-I	5812-II	5812-HPHV
Chlorine Gas	Brown	5810-O	5810-I	5810-II	5810-HPHV
Chlorine Water	Green	5813-O	5813-I	5813-II	5813-HPHV
Chlorine Water	Yellow	5653-O	5653-I	5653-II	5653-HPHV
Circulating Water	Green	5654-O	5654-I	5654-II	5654-HPHV
City Water	Green	5655-O	5655-I	5655-II	5655-HPHV
Cold Water	Green	5658-O	5658-I	5658-II	5658-HPHV
Cold Water Return	Green	80548	80549	80550	80551
Compressed Air	Blue	5660-O	5660-I	5660-II	5660-HPHV
Compressed Air	Yellow	5661-O	5661-I	5661-II	-
Condensate	Yellow	5662-O	5662-I	5662-II	5662-HPHV
Condensate Drain	Green	5663-O	5663-I	5663-II	5663-HPHV
Condensate Return	Yellow	5664-O	5664-I	5664-II	5664-HPHV
Condenser Water Return	Green	5665-O	5665-I	5665-II	5665-HPHV
Cooling Water	Green	5668-O	5668-I	5668-II	5668-HPHV
Deionized Water	Green	5671-O	5671-I	5671-II	5671-HPHV
Demin. Water	Blue	5814-O	5814-I	5814-II	5814-HPHV
Demin. Water	Green	5672-O	5672-I	5672-II	5672-HPHV
Domestic Cold Water	Green	5673-O	5673-I	5673-II	5673-HPHV
Domestic Hot Water	Green	5815-O	5815-I	5815-II	5815-HPHV
Domestic Hot Water	Yellow	5675-O	5675-I	5675-II	5675-HPHV
Domestic Hot Water Return	Green	5816-O	5816-I	5816-II	5816-HPHV
Domestic Hot Water Return	Yellow	5676-O	5676-I	5676-II	5676-HPHV

High-Performance Pipe Markers

BradyID.com/s36

High Performance Pipe Marker Legends (continued)

Legend	Color	Style O	Style I	Style II	Style HPHV
Domestic Hot Water Supply	Green	5817-O	5817-I	5817-II	5817-HPHV
Domestic Hot Water Supply	Yellow	5677-O	5677-I	5677-II	5677-HPHV
Drain	Green	5678-O	5678-I	5678-II	5678-HPHV
Drain	Yellow	5679-O	5679-I	5679-II	-
Drilling Mud	Yellow	-	-	131057	-
Ethylene Oxide	Orange	5818-O	5818-I	5818-II	5818-HPHV
Filtrate	Green	5819-O	5819-I	5819-II	5819-HPHV
Filtrate	Yellow	5685-O	5685-I	5685-II	5685-HPHV
Fire Auto Sprinklers	Red	5686-O	5686-I	5686-II	5686-HPHV
Fire Protection	Red	5688-O	5688-I	5688-II	5688-HPHV
Fire Protection Water	Red	5689-O	5689-I	5689-II	5689-HPHV
Floor Drain	Green	5820-O	5820-I	5820-II	5820-HPHV
Floor Drain	Yellow	5690-O	5690-I	5690-II	-
Foul Condensate	Yellow	5691-O	5691-I	5691-II	5691-HPHV
Fresh Water	Green	5692-O	5692-I	5692-II	5692-HPHV
Fuel Oil	Yellow	5695-O	5695-I	5695-II	5695-HPHV
Fuel Oil Return	Yellow	5696-O	5696-I	5696-II	5696-HPHV
Fuel Oil Supply	Yellow	5697-O	5697-I	5697-II	5697-HPHV
Gas	Brown	5821-O	5821-I	5821-II	5821-HPHV
Gas	Yellow	5698-O	5698-I	5698-II	5698-HPHV
Gas Air	Yellow	-	-	131060	-
Gas Mist	Yellow	-	-	131061	-
Green Liquor	Orange	5822-O	5822-I	5822-II	5822-HPHV
Green Liquor	Yellow	5699-O	5699-I	5699-II	5699-HPHV
Heating Return	Green	5823-O	5823-I	5823-II	5823-HPHV
Heating Return	Yellow	5700-O	5700-I	5700-II	5700-HPHV
Heating Supply	Green	5824-O	5824-I	5824-II	5824-HPHV
Heating Supply	Yellow	5701-O	5701-I	5701-II	5701-HPHV
Heating Water Return	Green	5825-O	5825-I	5825-II	5825-HPHV
Heating Water Return	Yellow	5702-O	5702-I	5702-II	5702-HPHV
Heating Water Supply	Green	5826-O	5826-I	5826-II	5826-HPHV
Heating Water Supply	Yellow	5703-O	5703-I	5703-II	5703-HPHV
Heavy Black Liquor	Orange	5827-O	5827-I	5827-II	5827-HPHV
High Pressure Condensate	Green	5829-O	5829-I	5829-II	5829-HPHV
High Pressure Steam	Green	5828-O	5828-I	5828-II	5828-HPHV
High Pressure Steam	Yellow	5706-O	5706-I	5706-II	5706-HPHV
Hot Oil	Yellow	-	-	131059	-
Hot Water	Green	5830-O	5830-I	5830-II	5830-HPHV
Hot Water	Yellow	5707-O	5707-I	5707-II	5707-HPHV
Hot Water Return	Green	5831-O	5831-I	5831-II	5831-HPHV
Hot Water Return	Yellow	5708-O	5708-I	5708-II	5708-HPHV
Hot Water Supply	Green	5832-O	5832-I	5832-II	5832-HPHV
Hot Water Supply	Yellow	5709-O	5709-I	5709-II	5709-HPHV
Hydraulic Fluid	Yellow	5710-O	5710-I	5710-II	5710-HPHV
Hydraulic Oil	Yellow	5711-O	5711-I	5711-II	-
Hydrochloric Acid	Orange	5833-O	5833-I	5833-II	5833-HPHV
Hydrochloric Acid	Yellow	5712-O	5712-I	5712-II	5712-HPHV
Hydrogen	Brown	5834-O	5834-I	5834-II	5834-HPHV
Hydrogen Peroxide	Orange	5835-O	5835-I	5835-II	5835-HPHV
Instrument Air	Blue	5716-O	5716-I	5716-II	5716-HPHV
Instrument Air	Yellow	5715-O	5715-I	5715-II	5715-HPHV
Lime	Orange	5836-O	5836-I	5836-II	5836-HPHV
Lime Mud	Orange	5837-O	5837-I	5837-II	5837-HPHV
Lime Mud	Yellow	5718-O	5718-I	5718-II	5718-HPHV
Low Pressure Condensate	Green	5838-O	5838-I	5838-II	5838-HPHV
Low Pressure Condensate	Yellow	5719-O	5719-I	5719-II	5719-HPHV
Low Pressure Steam	Green	5839-O	5839-I	5839-II	5839-HPHV
Low Pressure Steam	Yellow	5720-O	5720-I	5720-II	5720-HPHV
Lube Oil	Yellow	5721-O	5721-I	5721-II	5721-HPHV
Make-Up Water	Green	5722-O	5722-I	5722-II	5722-HPHV
Medium Pressure Steam	Green	5840-O	5840-I	5840-II	5840-HPHV
Medium Pressure Steam	Yellow	5723-O	5723-I	5723-II	5723-HPHV
Mill Air	Blue	5724-O	5724-I	5724-II	5724-HPHV
Mill Water	Green	5725-O	5725-I	5725-II	-

Legend	Color	Style O	Style I	Style II	Style HPHV
Natural Gas	Brown	5841-O	5841-I	5841-II	5841-HPHV
Natural Gas	Yellow	5726-O	5726-I	5726-II	-
Nitric Acid	Orange	5842-O	5842-I	5842-II	5842-HPHV
Nitric Acid	Yellow	5727-O	5727-I	5727-II	5727-HPHV
Nitrogen	Green	5728-O	5728-I	5728-II	5728-HPHV
Nitrogen	Yellow	5729-O	5729-I	5729-II	5729-HPHV
Non-Potable Water	Green	5843-O	5843-I	5843-II	5843-HPHV
Non-Potable Water	Yellow	5730-O	5730-I	5730-II	5730-HPHV
Noncondensable Gas	Yellow	5731-O	5731-I	5731-II	5731-HPHV
Overflow	Green	5733-O	5733-I	5733-II	-
Oxygen	Blue	5734-O	5734-I	5734-II	5734-HPHV
Oxygen	Green	5735-O	5735-I	5735-II	5735-HPHV
Oxygen	Yellow	5736-O	5736-I	5736-II	5736-HPHV
Peroxide	Green	5844-O	5844-I	5844-II	5844-HPHV
Peroxide	Yellow	5737-O	5737-I	5737-II	5737-HPHV
Plant Air	Blue	5845-O	5845-I	5845-II	5845-HPHV
Plant Air	Yellow	5738-O	5738-I	5738-II	5738-HPHV
Plant Water	Green	5739-O	5739-I	5739-II	5739-HPHV
Polymer	Yellow	5740-O	5740-I	5740-II	5740-HPHV
Potable Water	Green	5744-O	5744-I	5744-II	-
Process Water	Green	5747-O	5747-I	5747-II	5747-HPHV
Process Water	Yellow	5746-O	5746-I	5746-II	5746-HPHV
Propane Gas	Brown	5846-O	5846-I	5846-II	5846-HPHV
Propane Gas	Yellow	5748-O	5748-I	5748-II	5748-HPHV
Pulp	Green	5847-O	5847-I	5847-II	5847-HPHV
Raw Water	Green	5750-O	5750-I	5750-II	-
River Water	Green	5753-O	5753-I	5753-II	5753-HPHV
Roof Drain	Green	5754-O	5754-I	5754-II	5754-HPHV
Sanitary Sewer	Yellow	5755-O	5755-I	5755-II	5755-HPHV
Seal Water	Green	5758-O	5758-I	5758-II	5758-HPHV
Seal Water	Yellow	5757-O	5757-I	5757-II	5757-HPHV
Sodium Chlorate	Orange	5849-O	5849-I	5849-II	5849-HPHV
Sodium Hypochlorite	Orange	5848-O	5848-I	5848-II	5848-HPHV
Sodium Hypochlorite	Yellow	5761-O	5761-I	5761-II	5761-HPHV
Spent Acid	Orange	5850-O	5850-I	5850-II	5850-HPHV
Sprinkler Water	Red	5765-O	5765-I	5765-II	5765-HPHV
Steam	Green	5851-O	5851-I	5851-II	5851-HPHV
Steam	Yellow	5767-O	5767-I	5767-II	5767-HPHV
Storm Drain	Green	5769-O	5769-I	5769-II	5769-HPHV
Strong Black Liquor	Orange	5852-O	5852-I	5852-II	5852-HPHV
Sulfur Dioxide	Orange	5854-O	5854-I	5854-II	5854-HPHV
Sulfuric Acid	Orange	5853-O	5853-I	5853-II	5853-HPHV
Sulfuric Acid	Yellow	5774-O	5774-I	5774-II	5774-HPHV
Treated Water	Green	5775-O	5775-I	5775-II	5775-HPHV
Turpentine	Yellow	5776-O	5776-I	5776-II	5776-HPHV
Vacuum	Blue	5778-O	5778-I	5778-II	5778-HPHV
Vacuum	Green	5777-O	5777-I	5777-II	5777-HPHV
Vacuum	Yellow	5779-O	5779-I	5779-II	5779-HPHV
Vent	Blue	5855-O	5855-I	5855-II	5855-HPHV
Vent	Green	5780-O	5780-I	5780-II	-
Vent	Yellow	5781-O	5781-I	5781-II	-
Warm Mill Water	Green	5782-O	5782-I	5782-II	5782-HPHV
Warm Water	Green	5783-O	5783-I	5783-II	5783-HPHV
Waste Water	Yellow	5784-O	5784-I	5784-II	5784-HPHV
Waste Water Effluent	Green	5857-O	5857-I	5857-II	5857-HPHV
Water	Green	5786-O	5786-I	5786-II	-
Water	Yellow	5787-O	5787-I	5787-II	5787-HPHV
Weak Black Liquor	Orange	5860-O	5860-I	5860-II	5860-HPHV
Weak Wash	Orange	5859-O	5859-I	5859-II	5859-HPHV
Well Water	Green	5790-O	5790-I	5790-II	5790-HPHV
White Liquor	Orange	5858-O	5858-I	5858-II	5858-HPHV
White Liquor	Yellow	5791-O	5791-I	5791-II	5791-HPHV
White Water	Green	5793-O	5793-I	5793-II	5793-HPHV
White Water	Yellow	5792-O	5792-I	5792-II	-

Pipe Markers

Pipe Marker Accessories

BradyID.com/s36

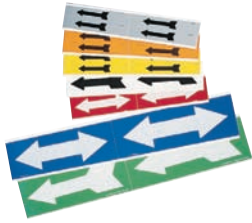

Self Sticking Vinyl Arrows

- Durable B-946 material withstands the elements indoors or out
- Mounted on easy-to-use cards
- Available as single or double arrows

	1.125 in. x 7 in. (4/Card)	2.5 in. x 7 in. (2/Card)	4 in. x 12 in. (2/Card)
Single Direction Arrow			
Blk/Ylw	93242	76507	93390
Wht/Blu	93247	76502	93392
Wht/Rd	93252	76505	93394
Wht/Grn	93257	76503	93396
Blk/Org	93262	76504	-
Wht/Brwn	109935	109933	109931
Blk/Wht	93267	76506	-
Blk/Alum	93272	76501	-
Double Direction Arrow			
Blk/Ylw	93243	76514	93391
Wht/Blu	93248	76509	-
Wht/Rd	-	76512	93395
Wht/Grn	93258	76510	93397
Wht/Brwn	109936	109934	109932



Reflective Pipe Banding

- Reflective vinyl increases night time visibility throughout your facility
- Withstands temperatures of -40° F (-40° C) to 180° F (82° C)
- Exceeds Federal Spec. C-S-300, Class I and FP-79 type II

Color	1 in. x 30 ft.	2 in. x 30 ft.	4 in. x 30 ft.
Yellow	105976	105982	105988
Green	105973	105979	105985
Red	105974	105980	105986
Blue	105972	105978	105984
Orange	105971	105977	105983
White	105975	105981	105987



Directional Flow Arrow Tape

- Durable B-946 material withstands the elements indoors or out
- Provides visibility on all side of pipe
- Supplied in liner-mounted rolled form

Color	1 in. x 30 yds (1440 Arrows)	2 in. x 30 yds (720 Arrows)	4 in. x 30 yds (270 Arrows)
Blk/Ylw	91424	91420	91287
Wht/Grn	91425	91421	91290
Blk/Grn	91412	91416	91408
Wht/Rd	91426	91422	91288
Wht/Blu	91427	91423	91289
Blk/Wht	91413	91417	91409
Blk/Org	91414	91418	91410
Blk/Gry	91415	91419	91411
Wht/Brwn	109928	109929	109930



ISO 14726 Banding Tape

- Help reduce accidents and damage to machinery
- ISO14726 Marine Standard defines the principle colors for identifying pipes - each color indicates a certain gauge of substances

Color	1 in. x 30 yds	2 in. x 30 yds	4 in. x 30 yds
Green	-	105564	105574
Blue	-	105562	105572
Brown	-	105563	105573
Gray	-	105565	105575
Purple	-	-	105576
Maroon	105557	105567	105577



Solid Color Banding Tape

- Durable B-946 material withstands the elements indoors or outdoors
- Meets ASME color field size when used in combination with worded legends and directional flow arrows

Color	1 in. x 30 yds	2 in. x 30 yds	4 in. x 30 yds
White	91429	91431	91433
Clear	36309	36314	36319
Yellow	36301	55260	36287
Green	36304	55263	36290
Red	36302	55261	36288
Orange	91428	91430	91432
Blue	36303	55262	36289
Brown	36305	36310	36315
Black	36306	36311	36316
Gray	36307	36312	36317
Purple	36308	36313	36318



Stock IIAR Tape

- Ideal for use with IIAR Pipe Markers
- Made of B-946 Self-Sticking Vinyl
- Use arrow tapes to indicate flow direction

Legend	Color	2 in. x 30 yds	4 in. x 30 yds
VAP	BK on BL	55364	55365
HIGH	BK on RD	-	55368
LOW	BK on GR	-	55371

How many rolls do I need?

Use this guide to help estimate approximately how many pipes you can mark with a 30-yard roll of tape.

- 1 in. pipe = 260 wraps
- 2 in. pipe = 150 wraps
- 3 in. pipe = 100 wraps
- 4 in. pipe = 80 wraps
- 5 in. pipe = 60 wraps

- 6 in. pipe = 50 wraps
- 7 in. pipe = 40 wraps
- 8 in. pipe = 35 wraps
- 9 in. pipe = 30 wraps
- 10 in. pipe = 30 wraps

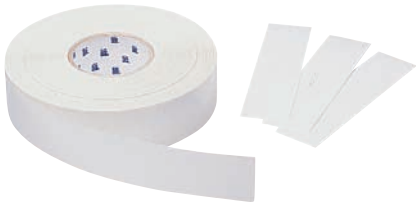

Tape Strip Rolls

- Use to re-secure wrap-around pipe markers should they become damaged need to be moved

Catalog #	Description
59946	2 in. x 30 yards Tape Strip Roll



Quik-Appl™ Nylon Straps

- Can be used with a variety of tags including valve and lockout tags
- For larger outer diameters, use BradyLock Fasteners

Catalog #	Outside Dia.	Strap Length
91165	1 in.	6 in.
91166	2 in.	7 in.



Bradylock™ Fastener

- Self-locking heavy-duty plastic fastener for Strap-On Markers
- Excellent chemical resistance

Catalog #	Description
41772	0.5 in. x 150 ft. Bradylock Fastener



Stainless Steel Wire

- 32 mil stainless steel safety wire to be used with wire twister pliers

Catalog #	Description	Length
15424	Stainless Steel Safety Wire	1,800 ft.



Stainless Steel Strapping

- Type 316 Stainless Steel Strapping is highly corrosion and heat resistant
- Ideal for HPHV pipe markers
- Continuous form requires separate stainless steel heads for uses other than HPHV pipe marker installation

Catalog #	Description
42331	0.25 in. x 100 ft. Steel Strapping
42332	0.25 in. x 250 ft. Steel Strapping



Banding Heads

- Use with continuous stainless steel strapping to create secure closures
- Stainless steel heads fit 0.25 in. strapping

Catalog #	Description	Qty.
90910	Stainless Steel Banding Heads	100

Custom Legend pipe markers available in a variety of sizes, colors and styles.

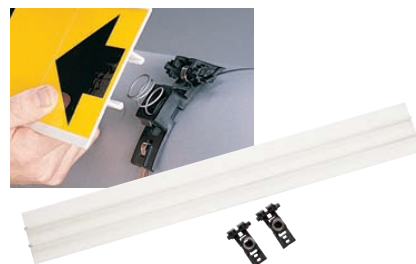

Blank HPHV Carrier

- Fiberglass carrier is blank (no label) and comes with two mounting clips
- Sized to accommodate labels up to 4.25 in. x 32 in.

Catalog #	Description	Qty.
59918	Blank HPHV Carrier	1

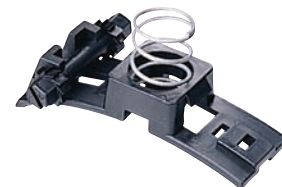

HPHV Mounting Clips

- For use with HPHV pipe markers

Catalog #	Description	Qty.
42335	Heavy Duty Clip	1

Custom Pipe Markers

BradyID.com/s36

Custom Pipe Markers

Use the information below to help create your own custom pipe markers then use the following form to order.



B-946 Self-Sticking Marker Styles and Sizes

Style Code	Style Example	Outside Diameter	Letter Height	Marker Size
Style: 1HV		8 in. or greater	3.5 in.	One 4 in. x 24 in. marker per card
Style: 1		2.5 in. to 7.875 in.	2 in.	One 2.25 in. x 14 in. marker per card
Style: 3C		less than 0.75 in.	0.3 in.	Three 2.25 in. x 2.75 in. markers per card plus 8 strips of arrow tape
Style: 4		0.75 in. to 2.378 in.	0.75 in.	Four 1.125 in. x 7 in. markers per card*

* Use in conjunction with 1 in. arrow tape to meet the ANSI marking requirement of 8 in.



Wrap-Around Marker Styles and Sizes

Style Code	Style Example	Outside Diameter	Letter Height	Marker Size
Style: 0		0.5 in. to 1.375 in.	0.5 in.	8 in. x 5 in. (uncoiled)
Style: I		1.5 in. to 2.378 in.	0.75 in.	9 in. x 8 in. (uncoiled)
Style: II		2.5 in. to 7.875 in.	1.25 in.	26 in. x 12 in. (uncoiled)



HPHV Marker Style and Size Chart

Style Code	Style Example	Outside Diameter	Letter Height	Marker Size
Style: HPHV		8 in. or larger	3.5 in.	4 in. x 24 in. (includes 2 mounting clips and 2 arrows)



BradySnap-On™ Marker Styles and Sizes

Style Code	Style Example	Outside Diameter	Letter Height	Marker Length
Style: A		0.75 in. to 1.375 in.	0.5 in.	8 in.
Style: B		1.5 in. to 2.375 in.	0.75 in.	9 in.
Style: C		2.5 in. to 3.875 in.	1.25 in.	13 in.
Style: D		4 in. to 6 in.	1.25 in.	21 in.



Strap-On Marker Styles and Sizes

Style Code	Style Example	Outside Diameter	Letter Height	Marker Size
Style: F		6 in. to 7.875 in.	1.25 in.	8 in. x 16 in.
Style: G		8 in. to 9.875 in.	2.5 in.	10 in. x 24 in.
Style: H		10 in. to 15 in.	3.5 in.	10 in. x 32 in.



Self-Sticking Semiconductor Marker Style and Size Chart

Style Code	Style Example	Outside Diameter	Marker Size
Style: 28		less than 0.75 in.	0.5 in. x 2.25 in. (28 markers per card)



Snap-On Fiber Optic and Coaxial Cable Marker Styles and Sizes

Style Code	Outside Diameter	Marker Size
Cable Style: 12	0.375 in. to 0.625 in.	12 in. color field
Cable Style: 8	0.375 in. to 0.625 in.	8 in. color field
Cable Style: 5	0.375 in. to 0.625 in.	5 in. color field

Custom Pipe Marker Order Form

Order Quote Artwork Attached Ship Via: _____ P.O. # or Request # : _____

Customer information

Company Name: _____ Name: _____
 Address 1: _____ Phone #: _____
 Address 2: _____ Fax #: _____
 City: _____ State: _____ Zip: _____
 Email: _____

Distributor information

Distributor: _____ Contact Name: _____
 Account #: _____ Fax #: _____ Phone #: _____

Custom pipe markers

Legend	Color* (Text / Bkgd)	Marker Style Code	Quantity
1.			
2.			
3.			
4.			
5.			
6.			
7.			
8.			
9.			
10.			

Marker style reference

Style	Pipe Outside Diameter	Qty.
B-946 Self-Sticking Markers		
1	2.5 to 7.875 in.	1 marker
1HV	8 in. or larger	1 marker
3c	Less than 0.75 in.	3 / card
4	0.75 in. to 2.375 in.	4 / card
B-689 Wrap-around Markers		
O	0.5 in. to 1.375 in.	1 marker
I	1.5 in. to 2.375 in.	1 marker
II	2.5 in. to 7.875 in.	1 marker
III	8 in. to 10 in.	1 marker
IV	10 in. or larger to 16 in.	1 marker
V	16 in. or larger to 22 in.	1 marker
VI	22 in. or larger to 26 in.	1 marker
High Performance (HPHV) Markers		
HPHV	8 in. or larger	1 marker

Style	Pipe Outside Diameter	Qty.
Snap-On Markers		
A	0.75 in. to 1.375 in.	1 marker
B	1.5 in. to 2.375 in.	1 marker
C	2.5 in. to 3.875 in.	1 marker
D	4 in. to 6 in.	1 marker
Strap-On Markers		
F	6 to 7.875 in.	1 marker
G	8 in. to 9.875 in.	1 marker
H	10 in. to 15 in.	1 marker
B-946 Semiconductor Markers		
28	0.75 in. or less	28 / card
Cable Markers		
CABLE	0.75 in. to 0.625 in.	1 marker

Marker color reference

Pipe Classification	Background Color
Fire quenching fluids	White on Red
Toxic and corrosive fluids	Black on Orange
Flammable fluids	Black on Yellow
Combustible fluids	White on Brown
Potable, cooling, boiler feed and other water	White on Green
Compressed air	White on Blue

Custom colors available including gray, black, purple and clear.

HazCom OSHA Standards and GHS Compliance

OSHA's Hazard Communication Standard directly affects all areas of chemical labeling and specify mandatory employee training. This means you need to know exactly what the Global Harmonized System (GHS) is and how it affects your business.

What is GHS?

GHS is an international system that the United Nations created for the unified classification and labeling of chemicals. It was officially adopted in the U.S. on March 26, 2012, by the Occupational Safety and Health Administration (OSHA).

Why does GHS matter?

GHS compliance is important because it gives employees the right to understand hazard information, rather than the right to know about potential hazards.

OSHA HazCom violations

HazCom was #2 on OSHA's Top 10 list of most frequently cited standards for fiscal year 2017.



Regulations

In the United States, OSHA is enforcing GHS by adopting it into its Hazard Communication Standard (CFR 1910.1200). It is focused on ensuring chemical safety in the workplace by requiring chemicals to be labeled and chemical hazards to be identified in a way that is easily understood by workers. It entails:

1910.1200(h)(1)

Employee information and training

1910.1200(e)(1)

Developing, implementing and maintaining a written HazCom program

1910.1200(g)(1)

Developing and maintaining written Safety Data Sheets

1910.1200(f)(1)

Labels on shipped containers

1910.1200(i)(1)

Employee training on new label elements and Safety Data Sheets



HazCom Program



Training



Labeling

Full compliance was required as of June 1, 2016

OSHA published an updated Hazard Communication standard in 2012 that incorporated the major elements of the GHS standards. A 3-year transitional period allowed companies time to fully implement the new GHS standards within their facility prior to the 2016 full compliance deadline. Below is an overview of each of the deadlines and some of the items that were required is listed below.

December 1, 2013	June 1, 2015	December 1, 2015	June 1, 2016
<p>Employers must train employees on the new label elements and Safety Data Sheet (SDS) format</p> <ul style="list-style-type: none"> ☑ Schedule and document periodic re-training on pictograms, labels and SDS ☑ Post GHS signs, posters, and hand out wallet cards ☑ Be able to demonstrate that workers clearly understand the hazards associated with each chemical they're exposed to, along with practice measures they must take ☑ Separate SDS and Material Safety Data Sheet (MSDS) binders and sheets as part of the management system. This helps you create secondary container labels with SDS information and determine which chemicals haven't been updated 	<p>Chemical manufacturers, importers and distributors reclassify chemicals, send SDS and GHS labels</p> <ul style="list-style-type: none"> ☑ Identify secondary container labeling needs and procedures ☑ Purchase GHS labeling equipment and supplies ☑ Implement labeling procedures (create your own or order pre-printed) based on new SDS sheets ☑ Archive old MSDS for determined amount of time (We recommend 30 years) ☑ Re-train on GHS as well as your existing HazCom system (NFPA/HMIS) until full conversion to GHS is complete 	<p>Distributors send only updated SDS and labels</p> <ul style="list-style-type: none"> ☑ Update your chemical database as new SDSs are received ☑ Review and ensure that all MSDS for any chemicals received after December 1, 2015, have been converted to SDS format ☑ Notify and document your communications with suppliers who have not provided new SDS information ☑ Audit all containers for compliance with updated regulations. Establish policies to control improperly labeled containers 	<p>Employer full compliance deadline</p> <ul style="list-style-type: none"> ☑ Ensure your training policy is in place, including new and existing chemical and internal product changes. Annual training is always recommended ☑ Update and complete a written HazCom program that includes a system of labeling, pictograms, training schedule and how/where to obtain more information ☑ Perform audits as conditions change or once a year to ensure program effectiveness



Continually enhance your HazCom program

Throughout your journey to HazCom/GHS compliance, you should always keep the following tasks in mind:

- Note any hazard or PPE changes on SDS sheets with each chemical that comes into your facility. As new chemicals are brought into your facility, new hazard and PPE needs may be required
- Ensure your written HazCom program is updated and reflects all internal and external changes
- Provide training to all new employees working with or around hazardous chemicals

Safety Data Sheets (SDS)

Formerly called Material Safety Data Sheets (MSDS), the new Safety Data Sheets (SDS) follow a consistent, user-friendly format to communicate chemical hazards. They provide the information that's needed to understand what the chemical is, what hazards it presents and how to respond to these hazards. SDSs must accompany any hazardous chemicals that are distributed. Most of the SDSs you need may be available online or through third party providers, such as MSDSONline.com.

When you need to create your compliant GHS labels, the SDS has the content you need. With the SDS information in hand, you're then ready to order pre-printed labels or quickly create labels onsite with the right printing system.

How do you obtain an SDS?

Chemical manufacturers, distributors or importers are required to create SDSs for any chemical they offer. These SDSs are then provided to the companies that purchase and use the chemicals, in order to effectively communicate any relevant chemical information and hazards.

The 16 elements of Safety Data Sheets (SDS)

The updated standards require that the chemical manufacturer, distributor or importer provide Safety Data Sheets (SDS) for each hazardous chemical to communicate information on these hazards. Each SDS is required to be presented in a consistent format, including the following sections:

Section 1: Identification

Chemical and recommended uses, and supplier contact information.

Section 2: Hazard(s) Identification

Hazards of chemical and the appropriate warning information.

Section 3: Composition/Information of Ingredients

Ingredients contained in the products.

Section 4: First-Aid Measures

Initial care that should be given by an untrained responder to an individual exposed to a chemical.

Section 5: Fire-Fighting Measures

Recommendations for fighting a fire caused by the chemical.

Section 6: Accidental Release Measures

Appropriate response to spills, leaks or releases, including containment and cleanup practices.

Section 7: Handling and Storage

Safe handling practices and conditions for safe storage.

Section 8: Exposure Controls/Personal Protection

Exposure limits, engineering controls and personal protective measures to minimize worker exposure.

Section 9: Physical and Chemical Properties

Physical and chemical properties associated with the substance.

Section 10: Stability and Reactivity

Reactivity hazards and stability information.

Section 11: Toxicology Information

Toxicological and health effects information or indicates data is unavailable.

Section 12: Ecological Information (non-mandatory)

Environmental impact of the chemical(s) if it were released to the environment.

Section 13: Disposal Considerations (non-mandatory)

Proper disposal practices, recycling or reclamation and safe handling practices.

Section 14: Transport Information (non-mandatory)

Classification information for shipping and transporting.

Section 15: Regulatory Information (non-mandatory)

Safety, health and environmental regulations specific for the product that is not indicated anywhere else on the SDS.

Section 16: Other Information

When the SDS was prepared or when the last known revision took place.

Brady's partnership with MSDSONline.com

Without a comprehensive online system to save and manage SDS information, users would have to input data manually in order to print the needed chemical labels. By utilizing Brady's partnership with MSDSONline, labels can be quickly populated and printed — saving you time and ensuring information is input correctly onto the label.



MSDSonline.com

Helps improve the real time management of chemical products and SDS



Brady Printers

Reliable label printing with a range of durable materials for specific applications or regulation requirements.



MSDSonline customers use SDS from their system to create labels that are formatted with the GHS label elements and can be printed to a variety of Brady label printers.

Symbols Guide

The new symbols, also known as hazard pictograms, each serve a special purpose and are used to identify hazardous products. While the environmental pictogram was not mandated by OSHA, it is listed because it may be required by other agencies for labeling.

Chemical and physical risk symbols



Explosion Bomb
Explosives, self-reactives, organic peroxides



Flame
Flammable gases, liquids, and solids; self-reactives; pyrophorics; self-heating



Flame Over Circle
Oxidizing gases, liquids and solids



Gas Cylinder
Compressed gases; liquefied gases; dissolved gases



Corrosion
Corrosives to metals

Health risk symbols



Corrosion
Skin corrosion; eye damage



Skull and Crossbones
Acute toxicity (severe, fatal)



Exclamation Mark
Irritant, dermal sensitizer, acute toxicity (harmful)



Health Hazard
Carcinogens, respiratory sensitizers, reproductive toxicity, target organ toxicity, germ cell mutagens

Environmental risk symbols



Environment
Aquatic toxicity
(Not regulated by OSHA)

The Environmental Protection Agency (EPA) has not yet incorporated GHS into its Federal Insecticide, Fungicide and Rodenticide Act (FIFRA) labeling requirements. Currently, a combination product that contains a pesticide and a fertilizer is regulated as a pesticide product under the FIFRA and must continue to be labeled in accordance with 40 CFR Part 156. However, some pesticide products may still be required to have an SDS.

The Six Elements of GHS Labels

GHS labels for primary containers must have six key elements in order to be compliant to the HazCom 2012 standard. All chemicals shipped from chemical manufacturers after June 1, 2015, must contain these six elements.

#6 Manufacturer information

Company name, address and phone number. (SDS Section 1)

#3 Product name or identifiers*

(SDS Section 1)

#4 Hazard statements

Phrases that describe the nature of hazardous products and associated risks if precautionary action is not taken. (SDS Section 2)

#1 Signal word

Indicates relative severity of hazard. DANGER is used for most severe instances, while WARNING is less severe. (SDS Section 2)

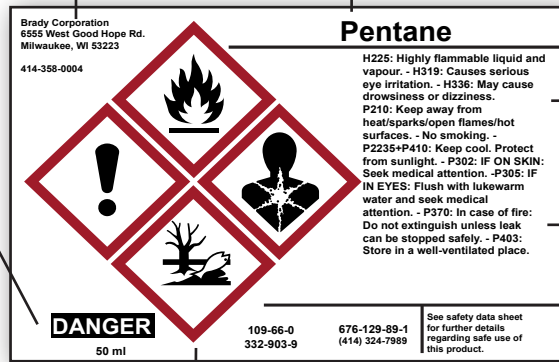

#2 Symbols (pictograms)

Convey health, physical and environmental hazard information with red diamond pictograms. May use a combination of one to five symbols. (SDS Section 2)

* Additional Product Identifiers

#5 Precautionary statements

Phrases associated with each hazard statement, that describe general preventative, response, storage or disposal precautions. (SDS Section 2)

Learn more with the *Streamlined Guide To GHS*

Brady understands that GHS has been a significant change for businesses and that there is a lot you need to do to become GHS compliant.

Download our extensive e-book for help navigating HazCom and GHS compliance.

▶ **Download at: BradyID.com/ghs**



Primary vs. Secondary Container



Primary container labeling

Primary chemical containers are bags, barrels, bottles, boxes, cans, cylinders, and drums that you receive from the manufacturer. These containers should be labeled following the GHS mandates and include all six labeling elements.

When a label is on a container directly from a supplier, this label cannot be removed, altered or defaced. If it needs to be replaced, the new label must contain the same information as the original.



Secondary container labeling

Secondary containers are usually smaller than primary container, such as spray bottles, jugs or jars. They usually hold chemicals that are transferred from a primary container.

Secondary containers must comply with GHS workplace labeling requirements except when the following criteria are met:

- The material is used within the work shift of the individual who makes the transfer
- The worker who made the transfer is in the work area the entire time during use
- The container stays in within the work area and in the possession of the worker who filled the container



Regulation information

OSHA has not changed the general requirements for secondary container labeling specifically. Employers have the option to create their own workplace labels by using all of the information provided by the manufacturer or using a combination of the elements in the GHS label example on page 366.

Employers may continue to use rating systems such as the National Fire Protection Association (NFPA) diamonds or Hazardous Materials Identification System (HMIS) requirements for workplace labels, as long as they are consistent with the HazCom 2012 / GHS standard.

Hazard Communication Training

OSHA requires all employees who are covered under the 29 CFR 1910.1200 regulation must complete initial training on the new Hazard Communication Standard updates and the GHS elements. To help you achieve and sustain complete compliance, Brady offers a full suite of training options.

GHS HazCom Training Program (DVD)

Used for: Initial GHS Training

- Two-video program focused specifically on the GHS elements
- Fulfills an initial training requirement
- Program is intended to ensure employees:
 - Understand the new GHS label elements
 - Are able to identify the new GHS pictograms
 - Are able to read and interpret GHS Safety Data Sheets (SDS)
- Includes: DVD with two videos (14 minute GHS Labeling Video and 10 minute GHS SDS Video), instructor's guide, employee quiz, presentation slides and five Employee Handbooks



Catalog #	Description	Qty.
132428	GHS HazCom Training Program Kit (English)	1
132429	Additional GHS HazCom Training Employee Handbooks (English)	5

HazCom Comprehensive Training Program (DVD)

Used for: Annual Refresher Training

- Fully comprehensive training program on OSHA's Hazard Communication Regulation (1910.1200) including GHS
- Fulfills annual refresher requirement
- Program is intended to ensure employees:
 - Understand types of hazardous materials in the workplace
 - Are able to read and understand labels and Safety Data Sheets (SDS)
 - Are able to understand how to safely use hazardous materials
- Includes: DVD, instructor's guide, employee quiz, presentation slides and five Employee Handbooks



Catalog #	Description	Qty.
132457	HazCom Comprehensive Training Program Kit	1
132458	Additional HazCom Comprehensive Training Employee Handbooks	5

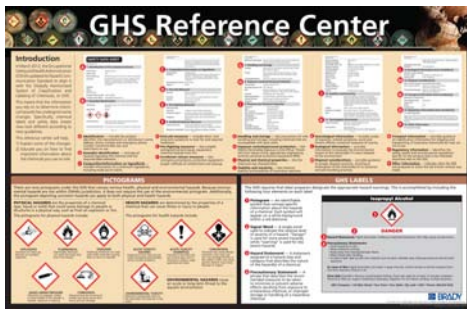

GHS Reference Center Poster

- This all-inclusive, large-format poster gets worker's attention and combines many of the most important changes into one easy-to-read format
- Includes detailed information on:
 - Safety Data Sheet (SDS) format
 - GHS-formatted label elements
 - GHS Hazard Pictograms

Catalog #	Description	Size	Qty.
133209	GHS Reference Center Poster	25.5 in. x 39.5 in.	1 each



GHS Pictograms Wallet Cards

- Wallet Cards outline all nine GHS hazard pictograms
- A great training aid to help employees become familiar with the new hazard pictograms, and as a handy reference for when the new GHS labels are entering your facility
- Made of laminated cardstock

Catalog #	Description	Size	Qty.
133208	GHS Pictograms Wallet Card	2.1 in. x 3.4 in.	10/pk



GHS Intro Poster Pack

- Set of 3 informational posters puts critical GHS information in your facility and to promote employee understanding
- Posters outline:
 - An overview of the Globally Harmonized System of Classification and Labeling of Chemicals
 - Information regarding the new Safety Data Sheets format and outline
 - Information regarding the new GHS-formatted label elements

Catalog #	Description	Size	Qty.
133207	GHS Intro Posters	17 in. x 22 in.	1 set of 3

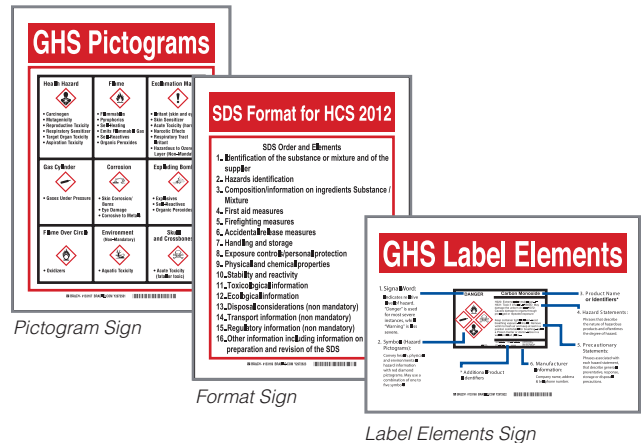

GHS Reference Signs

- Post signs to remind and reinforce label, pictogram and SDS training
- Choice of B-140 fiberglass or B-302 self-sticking polyester

Catalog #	Description	Material	Size	Qty.
133167	GHS Pictogram Overview Sign	Fiberglass	14 in. x 10 in.	1
133170	GHS Pictogram Overview Sign	Self-Sticking	14 in. x 10 in.	1
133168	GHS Label Elements Sign	Fiberglass	10 in. x 14 in.	1
133171	GHS Label Elements Sign	Self-Sticking	10 in. x 14 in.	1
133169	SDS Format Overview Sign	Fiberglass	14 in. x 10 in.	1
133172	SDS Format Overview Sign	Self-Sticking	14 in. x 10 in.	1

Print-Your-Own GHS Labels

Achieve full GHS compliance throughout your facility by utilizing easy-to-use label printers, label design software and a wide range of label materials from Brady.



How can I create a GHS label?

Printer built-in touchscreen app

Many of Brady's printers feature an easy-to-use touchscreen interface with built-in GHS label creation applications that make creating GHS labels simple.

Brady Workstation GHS Labels App

The Brady Workstation GHS App features built-in, pre-formatted layouts, pictograms, as well as drag and drop hazard statements so there's no need to type them all in. Once your label is created, print to any compatible Brady printer.

Brady's partnership with MSDSONline.com

By utilizing Brady's partnership with MSDSONline, labels can be quickly populated using the SDS data managed within your MSDSONline account – saving you time and ensuring information is correctly input onto the label. Once the label is created, print directly to a compatible Brady printer.



How can I print a GHS label?

Your printing solution can consist of a mono-color printer and label materials with pre-printed diamonds, or use a multi-color printer to print your own red diamonds on any blank label material.

Mono-color printing

Pre-printed diamond labels available for the following Brady printers:

- BradyPrinter S3000, BradyPrinter S3100, BradyPrinter i3300, BBP®35, BBP®37 and BBP®85 printers

Multi-color printing

Color printers capable of printing red diamonds on any blank label material:

- BBP®35, BBP®37 color printers
- BradyJet J2000 and J5000 color printers





Pre-Printed and Custom Labels

If a full printing system isn't an option for you, Brady still has solutions to help you get the GHS labels you need. From custom label options to individual pictogram labels, Brady has you covered.

Die-cut GHS pictogram labels

Printing your own GHS labels but can't get the pictograms you need? Use Brady's pre-printed GHS pictogram labels to add the necessary icons to your label. These are a great way to supplement mono-color label printers without investing in a brand new label printing system.

Custom GHS labels

Have Brady create your GHS labels for you! It's simple. Just fill in the forms on the following pages with your label content and specifications. Then send it back to Brady's custom quote team for pricing. From there, use your quote to place the order. That's it!

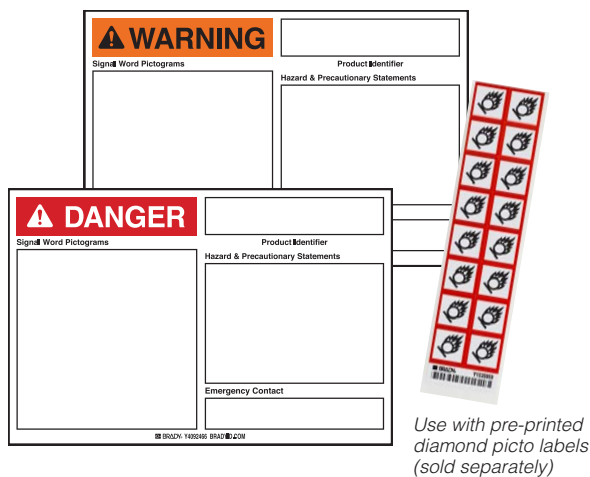

Write-On GHS Labels

- Ample room to include product identifier, hazard and precautionary statements, and emergency contact information
- Durable vinyl material for indoor or outdoor use
- Accommodate Brady's 5/8 in. or 1 in. pre-printed red diamond pictogram labels (sold separately)

Catalog #	Header	Size	Material	Qty.
145957	Warning	4 in. x 6 in.	Vinyl	50/pk
145956	Danger	4 in. x 6 in.	Vinyl	50/pk



Die-cut picto labels included on every label



Write-On GHS and NFPA Labels with Die-Cut GHS Pictos

- Convenient, write-on GHS labels
- Durable vinyl material for indoor or outdoor use
- Contains both GHS and NFPA label elements
- Included die-cut pictograms can be applied onto the label

Catalog #	Header	Size	Material	Qty.
148804	Warning	4 in. x 6 in.	Vinyl	25/roll
148805	Danger	4 in. x 6 in.	Vinyl	25/roll

Die-Cut GHS Pictogram Labels

- To be applied to primary and secondary container labels that do not already contain GHS pictogram symbols
- Ideal when printing black and white labels or when pictograms are not available in the label design process
- Picto labels must accompany all other required GHS label elements in order to meet OSHA standards



Explosive Picto Labels

Catalog #	Size	Material	Qty.
B-7569 Vinyl			
118815	5/8 in.	Vinyl	1 card of 39
118816	1 in.	Vinyl	1 card of 16
118817	2 in.	Vinyl	1 card of 4
B-235 Paper			
118869	5/8 in.	Paper	1 card of 39
118870	1 in.	Paper	1 card of 16
118871	2 in.	Paper	1 card of 4
B-7451 Polyester			
121188	1.5 in.	Polyester	1 card of 20
121202	2 in.	Polyester	Roll of 250
121201	4 in.	Polyester	Roll of 250



Flammable Picto Labels

Catalog #	Size	Material	Qty.
B-7569 Vinyl			
118821	5/8 in.	Vinyl	1 card of 39
118822	1 in.	Vinyl	1 card of 16
118823	2 in.	Vinyl	1 card of 4
B-235 Paper			
118875	5/8 in.	Paper	1 card of 39
118876	1 in.	Paper	1 card of 16
118877	2 in.	Paper	1 card of 4
B-7451 Polyester			
121190	1.5 in.	Polyester	1 card of 20
121203	2 in.	Polyester	Roll of 250
121189	4 in.	Polyester	Roll of 250



Oxidizing Picto Labels

Catalog #	Size	Material	Qty.
B-7569 Vinyl			
118827	5/8 in.	Vinyl	1 card of 39
118828	1 in.	Vinyl	1 card of 16
118829	2 in.	Vinyl	1 card of 4
B-235 Paper			
118881	5/8 in.	Paper	1 card of 39
118882	1 in.	Paper	1 card of 16
118883	2 in.	Paper	1 card of 4
B-7451 Polyester			
121191	1.5 in.	Polyester	1 card of 20
121205	2 in.	Polyester	Roll of 250
121204	4 in.	Polyester	Roll of 250



Gas Pressure Picto Labels

Catalog #	Size	Material	Qty.
B-7569 Vinyl			
118833	5/8 in.	Vinyl	1 card of 39
118834	1 in.	Vinyl	1 card of 16
118835	2 in.	Vinyl	1 card of 4
B-235 Paper			
118887	5/8 in.	Paper	1 card of 39
118888	1 in.	Paper	1 card of 16
118889	2 in.	Paper	1 card of 4
B-7451 Polyester			
121192	1.5 in.	Polyester	1 card of 20
121207	2 in.	Polyester	Roll of 250
121206	4 in.	Polyester	Roll of 250



Corrosive Picto Labels

Catalog #	Size	Material	Qty.
B-7569 Vinyl			
118839	5/8 in.	Vinyl	1 card of 39
118840	1 in.	Vinyl	1 card of 16
118841	2 in.	Vinyl	1 card of 4
B-235 Paper			
118893	5/8 in.	Paper	1 card of 39
118894	1 in.	Paper	1 card of 16
118895	2 in.	Paper	1 card of 4
B-7451 Polyester			
121198	1.5 in.	Polyester	1 card of 20
121213	2 in.	Polyester	Roll of 250
121197	4 in.	Polyester	Roll of 250



Severe Toxic Picto Labels

Catalog #	Size	Material	Qty.
B-7569 Vinyl			
118845	5/8 in.	Vinyl	1 card of 39
118846	1 in.	Vinyl	1 card of 16
118847	2 in.	Vinyl	1 card of 4
B-235 Paper			
118899	5/8 in.	Paper	1 card of 39
118900	1 in.	Paper	1 card of 16
118901	2 in.	Paper	1 card of 4
B-7451 Polyester			
121200	1.5 in.	Polyester	1 card of 20
121214	2 in.	Polyester	Roll of 250
121199	4 in.	Polyester	Roll of 250



Health Danger Picto Labels

Catalog #	Size	Material	Qty.
B-7569 Vinyl			
118851	5/8 in.	Vinyl	1 card of 39
118852	1 in.	Vinyl	1 card of 16
118853	2 in.	Vinyl	1 card of 4
B-235 Paper			
118905	5/8 in.	Paper	1 card of 39
118906	1 in.	Paper	1 card of 16
118907	2 in.	Paper	1 card of 4
B-7451 Polyester			
121196	1.5 in.	Polyester	1 card of 20
121212	2 in.	Polyester	Roll of 250
121195	4 in.	Polyester	Roll of 250



Acute Toxic Picto Labels

Catalog #	Size	Material	Qty.
B-7569 Vinyl			
118857	5/8 in.	Vinyl	1 card of 39
118858	1 in.	Vinyl	1 card of 16
118859	2 in.	Vinyl	1 card of 4
B-235 Paper			
118911	5/8 in.	Paper	1 card of 39
118912	1 in.	Paper	1 card of 16
118913	2 in.	Paper	1 card of 4
B-7451 Polyester			
121193	1.5 in.	Polyester	1 card of 20
121209	2 in.	Polyester	Roll of 250
121208	4 in.	Polyester	Roll of 250



Environmental Picto Labels

Catalog #	Size	Material	Qty.
B-7569 Vinyl			
118863	5/8 in.	Vinyl	1 card of 39
118864	1 in.	Vinyl	1 card of 16
118865	2 in.	Vinyl	1 card of 4
B-235 Paper			
118917	5/8 in.	Paper	1 card of 39
118918	1 in.	Paper	1 card of 16
118919	2 in.	Paper	1 card of 4
B-7451 Polyester			
121194	1.5 in.	Polyester	1 card of 20
121211	2 in.	Polyester	Roll of 250
121210	4 in.	Polyester	Roll of 250

Custom GHS Label Form

When ordering a Custom GHS Label from Brady, please have a Safety Data Sheet (SDS) in hand to fill in the form. The SDS, supplied from your chemical manufacturer must be up-to-date with GHS elements. All required label elements that are needed to fill this form out are found in sections 1-3 in your chemical SDS. (Once label has been created a proof will be provided.) Once complete, return this form to BradyUSAQuotes@BradyCorp.com or fax to 1-800-292-2289.

Customer Information

Company Name: _____ Name: _____
Address1: _____ Phone #: _____
Address2: _____ Fax #: _____
City: _____ State: _____ Zip: _____
Email: _____

Distributor Information

Distributor: _____ Contact Name: _____
Account #: _____ Fax #: _____ Phone #: _____

Label Specifications

Label Material

- B-302 Self-Sticking Polyester
- B-946 Vinyl
- B-7569 Economy Vinyl
- B-235 Coated Paper

Quantity and Size

(minimum order qty. of 25)

- 3 in. x 5 in. Qty. _____
- 4 in. x 6 in. Qty. _____
- 4.5 in. x 7 in. Qty. _____

Label Package

- Roll Form (100 labels minimum)
- Individual Labels

Label Content

Chemical/Product Name:

Signal Word:

(DANGER or WARNING)

Capacity:

Units:

Hazard Statements:

Located on your Safety Data Sheet, please include H-Code if available. i.e. H100

Precautionary Statements/First Aid:

Located on your Safety Data Sheet, please include P-Code if available. i.e. P100

GHS Pictograms:

Locate on your Safety Data Sheet and indicate pictogram number below:
1 minimum / 4 maximum

Diamond 1: _____ Diamond 3: _____

Diamond 2: _____ Diamond 4: _____



1. Corrosive 2. Severe Toxic 3. Explosive 4. Flammable 5. Environmental



6. Acute Toxic 7. Oxidizing 8. Gas Pressure 9. Health

Additional Label Content:

EC #: _____

CAS #: _____

Index #: _____

Reach Authorization #: _____

Internal Reference #: _____

Chemical Manufacturer Name: _____

Chemical Manufacturer Address: _____

Emergency Contact Phone #: _____

Multiple Languages Requested* _____

* Please indicate languages requested, then provide the necessary translations to the customer service rep after you have received the initial English proof.

Hazard Communication (RTK)

BradyID.com/s36



NFPA



HMIG Color Bar



NFPA



HMIG Color Bar



5 in. x 3 in. Container Labels

- Economical option for secondary container labeling
- Available with NFPA Diamond or HMIG Color Bar formats

Catalog #	Material	Format	Qty.
99175	Paper	HMIG Color Bar	500
121164	Vinyl	HMIG Color Bar	500
99195	Paper	NFPA	500
121146	Vinyl	NFPA	500

2 in. x 1.25 in. Lab Labels

- Paper or vinyl materials in NFPA Diamond or HMIG Color Bar formats
- Write-on labels allow you to customize your message

Catalog #	Material	Format	Qty.
58268	Paper	HMIG Color Bar	500
121161	Vinyl	HMIG Color Bar	500
99199	Paper	NFPA	500
121163	Vinyl	NFPA	500

3 in. x 5 in. Write-On Labels

- Customize these Blank RTK Labels by writing your own message on them and adding RTK pictograms

Catalog #	Material	Format	Qty.
121056	Vinyl	NFPA	50

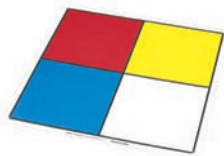

Blank NFPA Placards

- Meets NFPA's Code No. 704M and Federal Standard 313
- Place on potentially hazardous equip.
- Use with Gothic style Quik-Align® numbers and letters (sold separately)

Catalog #	Description	Size	Qty.
58656	Fiberglass	11 in.	1
58510	Fiberglass	16 in.	1
58500	Vinyl	2.5 in.	10
58501	Vinyl	5 in.	10
58502	Vinyl	7.5 in.	10
58503	Vinyl	10 in.	10
58504	Vinyl	15 in.	10
58272	Reflective	5 in.	10
58273	Reflective	7.5 in.	10
58274	Reflective	10 in.	10



NFPA Placard Kits

- Vinyl kits includes:
 - 10 blank NFPA placards
 - 10 characters each of 0 – 4, W, ☸, OXY, ACID, COR and ALK
- Fiberglass kits includes:
 - 1 blank NFPA placard
 - 10 characters each of 0 – 4, W, ☸, OXY, ACID, COR and ALK

Catalog #	Description	Size	Qty.
50053	Vinyl	10 in.	1 kit
50054	Vinyl	15 in.	1 kit
50055	Fiberglass	11 in.	1 kit
50056	Fiberglass	16 in.	1 kit

NFPA Diamond Labels

Catalog #	Description	Size	Qty.
53072	Vinyl	6 in. x 6 in.	500



NFPA Information Placards

- Placards graphically explain the NFPA Hazard Identification Coding System

Catalog #	Description	Size	Qty.
78788	Fiberglass	10 in. x 14 in.	1
58511	Vinyl	2.25 in. x 3.125 in.	1
76415	Vinyl	10 in. x 14 in.	1

HazCom Labels



HMIG Labels Station

- Features six 3/4 in. pockets for holding sheet labels, one 5 in. dowel to hold label rolls and a pen holder
- Displays hazard rating information

Catalog #	Description	Size	Qty.
PD674E	HMIG Label Station	11 in. x 18 in.	1

CHEMICAL NAME	PROTECTIVE EQUIPMENT GUIDE	
HEALTH	A	G G V G
FLAMMABILITY	B C	H H V A L
INSTABILITY	D	I J V A L
PROTECTIVE EQUIPMENT	E	F V G V K L L

HMIG Self-Laminating Labels

- Self-adhesive polyester label includes protective laminate cover
- Write in the rating on the left side
- Features index for required PPE

Catalog #	Description	Size	Qty.
60332	Self-Lam Label	2 in. x 3.5 in.	25
60333	Self-Lam Label	3 in. x 5 in.	25

HEALTH HAZARD		FLAMMABILITY		REACTIVITY/INSTABILITY	
1	2	1	2	1	2
3	4	3	4	3	4
5	6	5	6	5	6

RTK Wallet Card

- Handy wallet-sized reference card of the NFPA Hazard Identification Coding System

Catalog #	Description	Size	Qty.
58515	English	2.125 in. x 3.375 in.	25
89257	Spanish	2.125 in. x 3.375 in.	25

Hazardous Waste Labels

BradyID.com/s36

Hazardous Waste Labels

- Labels comply with all current federal regulations regarding identification of hazardous waste materials for transportation



Catalog #	Material	Size	Qty.
121155	Vinyl	6 in. x 6 in.	50
121151	Vinyl	6 in. x 6 in.	100
California Specific Labels			
121157	Vinyl	6 in. x 6 in.	50
121152	Vinyl	6 in. x 6 in.	100
New Jersey Specific Labels			
121156	Vinyl	6 in. x 6 in.	50
121144	Vinyl	6 in. x 6 in.	100



Catalog #	Material	Size	Qty.
121158	Vinyl	6 in. x 6 in.	50
121153	Vinyl	6 in. x 6 in.	100
121159	Paper	6 in. x 6 in.	100



Catalog #	Material	Size	Qty.
121154	Vinyl	6 in. x 6 in.	50
60447	Vinyl	6 in. x 6 in.	100
121064	Paper	6 in. x 6 in.	100



Catalog #	Material	Size	Qty.
121064	Vinyl	4 in. x 6 in.	50
121063	Vinyl	4 in. x 6 in.	100
60445	Paper	4 in. x 6 in.	100



Catalog #	Material	Size	Qty.
121061	Vinyl	4 in. x 4 in.	100
121438	Vinyl	6 in. x 6 in.	100



Catalog #	Material	Size	Qty.
87026	Paper	6 in. x 6 in.	50
87031	Vinyl	4 in. x 4 in.	50
87028	Vinyl	6 in. x 6 in.	50

Waste Disposal Labels

- Use to easily identify and sort waste

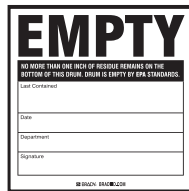

Catalog #	Material	Size	Qty.
121439	Vinyl	6 in. x 6 in.	100
60363	Paper	6 in. x 6 in.	100



Catalog #	Material	Size	Qty.
63240	Vinyl	6 in. x 6 in.	500



Catalog #	Material	Size	Qty.
121062	Vinyl	6 in. x 6 in.	100
60369	Paper	6 in. x 6 in.	100



Catalog #	Material	Size	Qty.
121436	Vinyl	6 in. x 6 in.	100
60364	Paper	6 in. x 6 in.	100

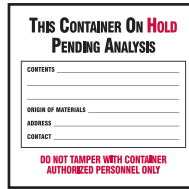

Catalog #	Material	Size	Qty.
121140	Vinyl	6 in. x 6 in.	100
60366	Paper	6 in. x 6 in.	100



Catalog #	Material	Size	Qty.
121437	Vinyl	6 in. x 6 in.	100
60362	Paper	6 in. x 6 in.	100



Catalog #	Material	Size	Qty.
121433	Vinyl	6 in. x 6 in.	100

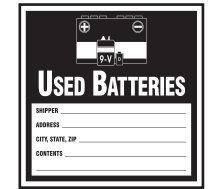

Catalog #	Material	Size	Qty.
121431	Vinyl	6 in. x 6 in.	100
60365	Paper	6 in. x 6 in.	100

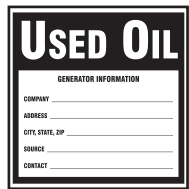

Catalog #	Material	Size	Qty.
121432	Vinyl	6 in. x 6 in.	100
60367	Paper	6 in. x 6 in.	100



Catalog #	Material	Size	Qty.
121434	Vinyl	6 in. x 6 in.	100



Catalog #	Material	Size	Qty.
121435	Vinyl	6 in. x 6 in.	100

HazCom Labels

Hazardous Material Shipping

BradyID.com/s36

Hazardous Material Shipping Labels

- Composite plastic material offers extreme weatherability so label colors stay bright
- Super tacky adhesive back permanently bonds to most surfaces (including low energy surfaces such as polyethylene bags)
- Labels withstand temperatures of -50°



Class 2:



121066 4 in. x 4 in. 500/roll



121065 4 in. x 4 in. 500/roll



121469 4 in. x 4 in. 500/roll

Class 3:



121067 4 in. x 4 in. 500/roll

Class 4:



121069 4 in. x 4 in. 500/roll



121068 4 in. x 4 in. 500/roll

Placard Labels and GHS

While GHS requires proper chemical labeling, the Department of Transportation (DOT) requires proper labeling when you're shipping chemicals.

This means when the product is shipped, the outer package must bear all of the required DOT marks and labels as well as the GHS label information if it is a primary container.

Essentially, DOT labeling does not change with GHS, but when the primary container is also the shipping container, you'll need both.

Class 5:



121071 4 in. x 4 in. 500/roll



121471 4 in. x 4 in. 500/roll

Class 6:



121466 4 in. x 4 in. 500/roll



63473 4 in. x 4 in. 500/roll



121467 4 in. x 4 in. 500/roll

Class 7:



121473 4 in. x 4 in. 500/roll



121441 4 in. x 4 in. 500/roll

Class 8:



121070 4 in. x 4 in. 500/roll

Class 9:



121141 4 in. x 4 in. 500/roll

HazCom Labels

Die-Cut Placard Numbers



Catalog #	Description	Qty.
5010-*	1 in. Quik-Align Numbers	10pk

Replace () with the desired number (0-9).
Example: To order die-cut 8, order # 5010-8.

Vehicle Placard Signs

Brady also offers a wide range of Vehicle Placard Signs for shipping hazardous materials.

View signs on page 463.



Regulations

OSHA standards require you to have SDS on hand for all chemicals at your facility.

1910.1200(g)(1)

Developing and maintaining written Safety Data Sheets

1910.1200(i)(1)

Employee training on new label elements and Safety Data Sheets



Bilingual Training Insert

- This detailed binder insert package contains:
 - OSHA Haz-Com Standard highlights and overview of program requirements
 - Compliance checklist
 - Two 15-page RTK training booklets,
 - 2-Sided RTK poster (Spanish/English)
 - 50 clear sheet protectors
 - A-Z index tabs

Catalog #	Description
BR801B	Bilingual Binder Insert



Standard MSDS Binders

- 1.5 in. dia. rings hold 275-300 sheets
- 2.5 in. dia. ring holds 400-500 sheets
- 3 in. dia. ring holds 600 sheets
- Durable polyethylene cover, 36 in. chain and pair of sheet lifters

Catalog #	Description
2023	1.5 in. MSDS Binder
2024	2.5 in. MSDS Binder
2025	3.0 in. MSDS Binder
2026	1.5 in. Bilingual MSDS Binder
2027	2.5 in. Bilingual MSDS Binder
2028	3.0 in. Bilingual MSDS Binder
BR801B	Binder Insert



GHS SDS Binders

- Complies with OSHA regulations
- 1.5 in. dia. ring holds 275-300 sheets
- 3 in. dia. ring holds 600 sheets
- Features a durable polyethylene cover, 36 in. chain and a pair of sheet lifters

Catalog #	Description
121183	1.5 in. SDS Binder, English
121184	3 in. SDS Binder, English
121185	1.5 in. SDS Binder, English/Spanish
121186	3 in. SDS Binder, English/Spanish
121187	3 in. SDS Binder, English/French



Double RTK Center

- This center includes red polystyrene board, 2 binder racks and two MSDS binders
- Center size: 20 in. x 29 in. x 4.5 in.

Catalog #	Description
2010DB	Double RTK Compliance Center



Economy RTK Center

- Includes MSDS v-style sign, 8 in. x 14.5 in. x 6 in.
- 1.5 in. MSDS binder with 300 sheet capacity

Catalog #	Description
2007	Economy RTK Center
RK085A	Rack and Binder w/inserts
2005	Rack and Binder Only



GHS SDS Centers

- 20 in. x 14 in. x 4.5 in. center offered in English and Spanish
- Includes 1.5 in. SDS binder, Right To Know Compliance Center backboard and yellow wire rack

Catalog #	Description
121370	SDS Center English
121371	SDS Center Spanish



RTK Compliance Center

- 20 in. x 14 in. x 4.5 in. compliance center includes red polystyrene board, binder rack and MSDS binder
- 1.5 in. binder w/ 300 sheet capacity

Catalog #	Description
2010	Compliance Center
RK018A	Compliance Center w/inserts
2010NB	Compliance Center w/o binder
2010SP	Spanish Compliance Center*

*Board is Spanish with 1.5 in. Bilingual Binder



High Visibility SDS Signs

- High visibility signs easily mount and project from the wall for easy viewing
- Made from heavy-duty B-493 plastic

Catalog #	Style	Size	Qty
139786	V-Shape	6 in. x 9 in. x 4 in.	1
139787	L-Shape	8 in. x 8 in.	1

Safety Information Centers

BradyID.com/s36



Information Centers

- Rugged poly backboard comes with white PVC coated wire basket, allowing for high visibility and convenience
- Tear resistant 3-ring binder holds approx. 300 sheets and includes chain and mounting hardware
- Center Size: 20 in. x 14 in.

Catalog #	Description
IC326E	Emergency Information Center



Bloodborne Pathogen Compliance Center

- Wall-mount display includes a 1.5 in. binder that holds up to 300 pages of your exposure control plans (not included)
- Center size: 20 in. x 14 in. x 4.5 in.

Catalog #	Description
BH2010	Bloodborne Pathogen Center
BH2023	Exposure Control Binder only



Standard Operating Procedures Center

- Poly backboard w/ white PVC coated wire basket
- Rugged binder holds approximately 300 sheets and comes with an attached chain
- Additional binders sold separately

Catalog #	Description
SM681A	Procedures Center
SM682A	Double Standard Operation Procedures Center



Lockout Procedure Station

- Durable polystyrene board includes pre-drilled holes and mounting hardware
- Backboard dimensions: 20 in. x 14 in. x 4.5 in.

Catalog #	Description
LOSP22	Station With Binder and 25 Forms
99289	Lockout Procedure Station With Binder Only
LOSB1	Lockout Procedure Binder Only



MSDS / Job Site Safety Document Center

- Table top or wall mount center holds one 3-ring binder in a weather resistant and lockable polystyrene case
- Size: 13.5 in. x 13.5 in. x 4.75 in.

Catalog #	Description
JS1	MSDS/Job Site Center



Standard RTK Center

- Acrylic board can hold up to 100 booklets and an MSDS binder
- Includes our 1.5 in. binder and 10 training booklets
- Center size: 30 in. x 24 in. x 4.5 in.

Catalog #	Description
2001	Standard Right to Know Center
2012	Board Only
2002	Bilingual version*

*Includes 5 English booklets, 5 Spanish booklets and a bilingual binder

HazCom Labels



Binder Holders

- PVC coated steel racks designed for holding binders up to 3 in. ring dia.
- Single: 9 in. x 14 in. x 4.5 in.
Double: 9 in. x 14 in. x 6.5 in.

Catalog #	Description	Color	Qty.
2014	Single Binder Holder	Yellow	1
2014W	Single Binder Holder	White	1
104791	Double Binder Holder	Yellow	1
104792	Double Binder Holder	White	1



Suggestion Box

- Wall or table mount black acrylic box w/ a lockable top and side pocket
- Box: 12 in. x 11.75 in. x 4.75 in.
Side pocket: 5 in. x 4 in. x 1.625 in.
Top drop slot: 9 in.

Catalog #	Description
MC111E	Suggestion Box

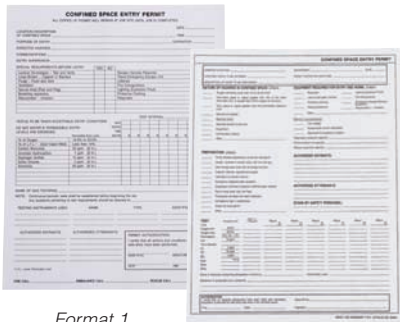

Format 1

Format 2

Confined Space Entry Permits

- 8.5 in. x 11 in. forms include all information required by OSHA's Confined Space Regulation
- Available in several materials to best meet your facility's environment

Catalog #	Description	Qty
EP1	Format 1 Permits	25/pk
65937	Format 2 Permits (2-ply Carbonless)	25/pk



Confined Space Permit Center

- Wall-mounted Permit Center provides ready access to entry permits while making employees aware of special safety requirements
- Holds 8.5 in. x 11 in. forms
Holder dimensions: 15.75 in. x 23.5 in.
- Permit forms sold separately

Catalog #	Description	Qty
PC1	Permit Center (Permit forms sold separately)	25/pk



Confined Space Entry Permit Holder

- Provides a confined space warning and easy access to permits
- Made of durable polycarbonate material
- Holds 8.5 in. x 11 in. forms
Holder dimensions: 12 in. x 19 in.
- Permit forms sold separately

Catalog #	Description	Qty
65903	Permit Holder (Permit forms sold separately)	1



Safe-T-Grip® Fuse Pullers

- Provides maximum convenience when removing or replacing cartridge fuses
- Notched handles for no-slip grip
- Clearly marked amperage ranges
- Exceeds MIL specifications
- For 0-100A, 250V and 600V fuses

Catalog #	Description
65280	Safe-T-Grip Fuse Pullers



E-Z Check® Plus GFI Circuit Tester

- Checks for the following conditions: correct wiring, open ground, reverse polarity, open hot, open neutral, hot on neutral, hot and ground reversed with open hot and ground fault interruption

Catalog #	Description
65273	E-Z Check Plus GFI Circuit Tester



Battery Cleaning and Charging Safety Kit

- Help minimize the risk of acid burns or shocks while charging batteries
- Fully equipped portable kit includes:
 - (1) pair of large unsupported neoprene over natural rubber gloves
 - (1) pair of clear chemical goggles
 - (1) 45 in. x 35 in. black rubber apron
 - (1) 8 in. synthetic brush
 - (2) 9.25 in. x 14.5 in. chemical sorbent pads
 - (1) quart neutralizing and cleaning agent
 - (1) laminated instruction card

Catalog #	Description
BCK	Battery cleaning and charging kit

Arc Flash Safety

What is arc flash and what causes it?

An arc flash is a short circuit through air that flashes from one exposed live conductor to another conductor or ground. This electrical fault can create a dangerous release of energy, including thermal energy, acoustical energy, pressure wave or debris.

There are many ways an arc flash can occur, including:

- Close proximity of a high-amp source to a conductive object
- Dropping a tool or creating a spark
- Breaks or gaps in insulation
- Failing equipment due to use of substandard parts, improper installation or even normal wear and tear
- Dust, corrosion or other impurities on the surface of the conductor

What impacts the size of an arc flash event?

Common variables that impact the size and energy of an arc flash include:

- Amperage
- Voltage
- Arc gap
- Closure time
- Distance from arc
- Three phase vs. single phase
- Confined space



Did You Know?

Anything above 50V that could be worked on while energized, resulting in exposure to electrical hazards, requires an arc flash label.

Examples include, but are not limited to:

- Switchboards
- Panel boards
- Motor control centers
- Industrial control panels
- Meter socket enclosures

NFPA 70E Standard for Electrical Safety in the Workplace

OSHA cites and fines employers for failure to protect employees from the dangers of arc flash under regulation 29 CFR 1910.333(a). The National Fire Protection Association (NFPA) details how to comply with this regulation through the NFPA 70E standard.

According to the NFPA 70E standard, there are six primary responsibilities that facilities must meet, including:

1. Training for employees
2. Written safety program in place that is actionable
3. Personal protective equipment (PPE) available for employees
4. Insulated tools
5. Arc flash hazard degree calculations
6. Properly labeled equipment

Most recent updates (2018)

The NFPA 70E gets updated every three years. Some of the most recent updates include:

- Updated training and retraining requirements
- Revision to arc flash warning label content
- Elimination of the PPE hazard category 0
- Elimination of prohibited approach boundary
- Additional boundary requirements
- Revisions to selecting appropriate PPE
- Minor terminology changes (such as work shoes now referred to as footwear)

What is an arc flash boundary?

An arc flash boundary is the distance at which an electrical arc can flash outward and endanger employees working on electrical equipment.

Additional boundary requirements include:

- Conductive articles of jewelry and clothing: Watchbands, bracelets, rings, key chains, necklaces, metal frame glasses, etc. shall not be worn within the restricted approach boundary
- Working space: Space shall be kept clear and not used for storage to permit safe operation and maintenance
- Barricades: When the arc flash boundary is greater than the limited approach boundary, barricades shall not be placed closer than the arc flash boundary
- Insulated tools: Employees shall use insulated tools when working inside the restricted approach boundary of exposed energized electrical conductors.

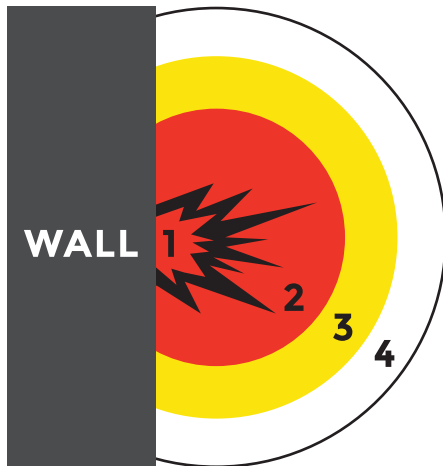

1. Exposed / energized conductor or circuit part

2. Restricted approach boundary

Distance where there is an increased likelihood of electric shock

3. Limited approach boundary

Distance where a shock hazard exists

4. Arc flash boundary

Distance from an arc source where the thermal energy exposure could cause 2nd degree burns on unprotected skin

Arc Flash Risk Assessment

The NFPA 70E 2015 edition requires employers to conduct an arc flash risk assessment to determine the amount of thermal energy that could be generated from an arc flash incident. The information is then used to define a flash protection boundary around the potential source, and to determine the level of arc-rated apparel and other personal protection equipment required when employees cross the boundary while they work on or near explosive live parts.

- ▶ **At minimum, the safety program needs to be audited at intervals not to exceed three years and arc flash risk assessments shall be periodically reviewed at intervals not to exceed five years.**

Who should perform arc flash risk assessments?

Completing a best-in-class arc flash risk assessment in-house requires time, resources and analysis software to accurately calculate arc flash risk. In addition, simple miscalculations can lead to incorrect incident energy levels resulting in the improper use of PPE.

Brady's **Arc Flash Risk Assessment Service**, performed by a licensed electrical engineer using power system analysis software, enables you to not only reach compliance, but maintain compliance. Additional services also include Arc Flash Audits and Arc Flash Safety Training.

Arc Flash Labels

BradyID.com/s36

Arc Flash Labeling

Who's responsible for labeling?

Arc flash labeling is the responsibility of the employer, not the manufacturer or installer of the equipment.

What needs to be labeled?

Labeling is required for any piece of electrical equipment that is likely to require examination, adjustment, service or maintenance while energized, creating the potential for an arc flash incident to occur.

Any modifications or renovations to electrical equipment that changes data on the label requires an updated arc flash risk assessment and label.

Where should the label be placed?

Markings must be in a location that is clearly visible to workers before they may be exposed to any potentially dangerous live parts. Typically, the label is placed outside the panel or enclosure door.



What needs to appear on the label?

Once an arc flash risk assessment has been conducted, in which the arc flash boundary, the incident energy at the working distance and the personal protective equipment required has been determined, Article 130.5 (C) in the 2015 edition of NFPA 70E further dictates that the label must contain these important elements.

Arc Flash Labels

Incident energy and corresponding working distance

Min. arc rating of clothes

Arc flash boundary

Site specific PPE

FLASH PROTECTION		SHOCK PROTECTION	
Incident Energy at:	18 in.	Shock Risk When Cover is Removed	480 VAC
Min. Arc Rating:	0.45 cal/cm ²	Limited Approach	42 in.
Arc Flash Boundary:	10 in.	Restricted Approach	12 in.
Glove Class:	00	Bus Name: PNL_P-5	
PPE: Shirt and pants or coverall, Nonmelting (ASTM F1506) or Untreated Fiber + hard hat + safety glasses + hearing protection		Prot Dev: 100/3 BS-18 LAB PNL	

Header

Shock hazard information

▶ Learn more with our free e-book at BradyID.com/arcflash

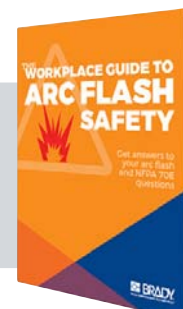

Brady Arc Flash Solutions



Arc flash services

Brady understands the importance of electrical safety as a whole and has licensed engineers who understand not only arc flash safety, but also the firsthand impact of arc flash risk. We work with your team to best protect your employees based on your custom facility and program requirements.

- **Arc Flash Risk Assessment**
A Brady safety electrical engineer completes your assessment, provides you with a detailed assessment report, including your single-line diagram, and installs the correct arc flash labels.
- **Arc Flash Audit**
Let our electrical engineer perform your arc flash audit and ensure your assessment is up to date and compliant.
- **Arc Flash Safety Training**
This custom approach to training incorporates both the NFPA regulation and your company-specific arc flash requirements to ensure participating employees can apply their knowledge.



Print your own labels

Create and print customized arc flash labels when and where you need them with an on-demand label printer. When you're working on a project, you can stop handwriting your labels, and print all the labels you need in batches. You also avoid the hassle of having to select, order and wait for pre-printed labels to arrive.



Pre-printed die-cut labels

Pre-printed arc flash labels with the arc flash PPE category and a list of the required PPE relieve the employer from having to hand-write this information. As with the check box labels, a version for both arc flash and shock hazards is available.

Arc Flash Labels

BradyID.com/s36

Pre-Printed Arc Flash Labels

- Labels come with the hazard category and PPE requirements preprinted
- Write in specifics such as minimum arc rating, protection boundary, etc.
- B-7569 vinyl can be written on with pen or marker



Catalog #	Header	Hazard	Size	Qty
121085	Warning	1	5 in. x 7 in.	5/pk.
121087	Warning	2	5 in. x 7 in.	5/pk.
121091	Warning	3	5 in. x 7 in.	5/pk.
121093	Warning	4	5 in. x 7 in.	5/pk.
121086	Danger	1	5 in. x 7 in.	5/pk.
121088	Danger	2	5 in. x 7 in.	5/pk.
121092	Danger	3	5 in. x 7 in.	5/pk.
121094	Danger	4	5 in. x 7 in.	5/pk.

Catalog #	Header	Hazard	Size	Qty
121097	Warning	1	4 in. x 6 in.	5/pk.
121099	Warning	2	4 in. x 6 in.	5/pk.
121101	Warning	3	4 in. x 6 in.	5/pk.
121103	Warning	4	4 in. x 6 in.	5/pk.
121098	Danger	1	4 in. x 6 in.	5/pk.
121100	Danger	2	4 in. x 6 in.	5/pk.
121102	Danger	3	4 in. x 6 in.	5/pk.
121104	Danger	4	4 in. x 6 in.	5/pk.

Write-On Arc Flash Labels

- Write in specifics such as minimum arc rating, protection boundary, etc.
- B-7569 vinyl can be written on with pen or marker



Catalog #	Header	Size	Qty
121077	Warning	5 in. x 7 in.	5/pk.
121078	Danger	5 in. x 7 in.	5/pk.

Catalog #	Header	Size	Qty
121079	Warning	4 in. x 6 in.	5/pk.
121080	Danger	4 in. x 6 in.	5/pk.



Catalog #	Header	Size	Qty
145975	Danger	5 in. x 7 in.	5/pk.
145974	Danger	4 in. x 6 in.	5/pk.
145973	Warning	5 in. x 7 in.	5/pk.
145972	Warning	4 in. x 6 in.	5/pk.

Arc flash hazard categories and PPE requirements

Required Flash Protection Equipment*	
Hazard Category 1 Incident energy 4 cal/cm ²	Arc-rated long-sleeve shirt and long pants (or arc-rated coverall)
	Arc-rated face shield or arc flash hood
	Arc-rated jacket, parka, rainwear or hard hat liner (as needed)
	Hard hat
	Safety glasses or safety goggles
Hazard Category 2 Incident energy 8 cal/cm ²	Hearing protection (ear canal inserts)
	Leather gloves
	Leather footwear (as needed)
	Arc-rated long-sleeve shirt and long pants (or arc-rated coverall)
	Arc-rated face shield or arc flash hood
Hazard Category 3 Incident energy 25 cal/cm ²	Arc-rated jacket, parka, rainwear or hard hat liner (as needed)
	Hard hat and arc-rated hard hat liner
	Safety glasses or safety goggles
	Hearing protection (ear canal inserts)
	Leather footwear
Hazard Category 4 Incident energy 40 cal/cm ²	Arc-rated gloves
	Arc-rated long-sleeve shirt and long pants (or arc-rated coverall)
	Arc-rated arc flash suit jacket and pants
	Arc-rated arc flash hood
	Arc-rated jacket, parka or rainwear (as needed)

* Arc rating of PPE should correspond with the Hazard Category and Incident Energy present. Voltage-rated gloves and other shock protection may also be required when working on exposed energized electrical parts.

Arc Flash Labels

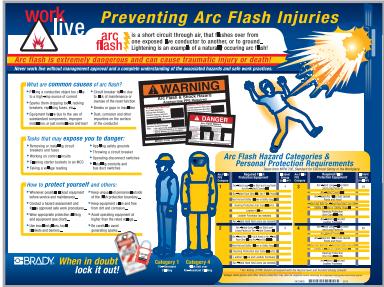

Poster

- Highlights the common causes of arc flash and provides safe work practices and personal protection equipment requirements
- Laminated on both sides to stand up to industrial environments
- Full-color printing and eye-catching graphics for optimum visual impact
- Poster reflects all changes from NFPA 70E-2015 regulation

Catalog #	Description	Quantity
104571	18 in. x 24 in. poster	1 each

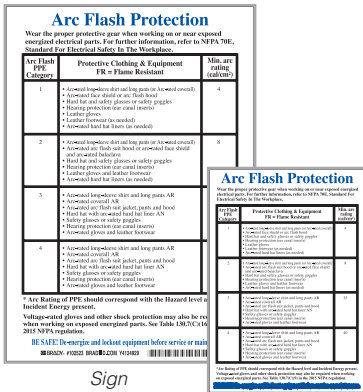

Sign and Label

- Post signs and labels in the work area and near electrical equipment to boost awareness and compliance
- Signs and labels specify the personal protection equipment required for each arc flash hazard category
- Sign and label reflects all changes from NFPA 70E-2015 regulation
- Sign: B-401 rigid plastic with laminated graphics
- Label: B-302 self-sticking polyester with overlaminates

Catalog #	Description	Quantity
102523	7 in. x 10 in. sign	1 each
102524	3.5 in. x 5 in. label	5/pack

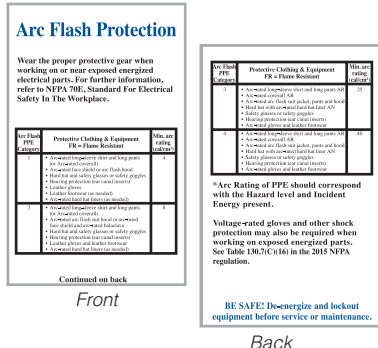

Wallet Card

- Ensure compliance and safety by providing each employee with their own arc flash wallet card
- Card specifies the personal protection equipment required for each arc flash hazard category
- Made of laminated cardstock
- Reflects all changes from NFPA 70E-2015 regulation

Catalog #	Description	Quantity
102525	2.1 in. x 3.4 in. card	25/pack



On-Site Arc Flash Training Service

Under the NFPA 70E standard, arc flash training must be completed every three years.

Brady's Arc Flash Safety Training is a custom approach to training that includes:

- Custom training materials with NFPA regulations and your company-specific arc flash information
- On-site interactive training session
- Attendees receive a workbook and a certificate of completion

Training topics include:

- What is an arc flash and related information, such as boundaries, labeling, work permits and PPE requirements
- OSHA regulations, responsibilities, training and PPE
- NFPA updates, compliance and PPE tables
- The difference between qualified and unqualified employees
- And more

For more info, visit BradyID.com/Services

Pre-Printed Labels

BradyID.com/s36

Conduit and Voltage Labels

- Orange markers meet ASME (ANSI) Standard ZG3.22 and alert employees to potentially dangerous machinery or energized equipment
- Cards sold individually



Legend	Style A	Style B	Style C
(blank)	44099	44100	-
110 Volts	44101	44201	44301
115 Volts	44102	44202	44302
120 Volts	44104	44204	44304
120/208 Volts	44159	44259	44359
208 Volts	44106	44206	44306
220 Volts	44107	44207	44307
230 Volts	44108	44208	44308
240 Volts	44110	44210	44310
250 Volts	44111	44211	44311
277 Volts	44112	44212	-
277/480 Volts	44160	44260	44360
440 Volts	44113	44213	44313
460 Volts	44114	44214	44314
480 Volts	44115	44215	44315
550 Volts	44116	44216	-
600 Volts	44118	44218	-
2300 Volts	44134	44234	-
2400 Volts	44121	44221	-
4160 Volts	44122	44222	-

Legend	Style A	Style B	Style C
4800 Volts	44124	-	-
6900 Volts	44125	-	-
7200 Volts	44126	-	-
13,200 Volts	44151	-	-
AC	44127	44227	44327
Air Conditioning	-	44247	44347
Circuit #	44155	44255	-
Circuit Breaker	44157	44257	-
DC	44138	44238	44338
Electric Out of Service	-	44250	-
Emergency Service	-	-	44328
Fuse Box	44158	44258	-
Heating Circuit	-	44248	-
Light and Power	-	44242	44342
Lights	44133	44233	44333
On/Off	-	44256	-
Power	44132	44232	44332
Single Phase	44129	44229	44329
Three Phase	44131	44231	44331
Volts	44149	-	-

120 VOLTS

Style A:

(1) 2.25 in. x 9 in. marker per card

120 VOLTS 120 VOLTS

Style B:

(4) 1.125 in. x 4.125 in. markers per card

120 VOLTS 120 VOLTS

Style C:

(18) 0.5 in. x 2.25 in. markers per card

Pre-Printed Labels



Warning Labels

- Call attention to hazards on paperwork, equipment and packages
- Made of B-946 pressure sensitive vinyl
- **0.5, 1 and 2 inch labels:** 10 per card, 10 cards per pack
- **4 inch labels:** 3 per card, 10 cards per pack
- **8 inch labels:** 1 per card, 10 cards per pack



No Smoking

60237	2 in. x 2 in.	Vinyl	50/pk.
-------	---------------	-------	--------

* 5 labels per card. 10 cards per pack



Acid

60184	0.5 in. x 0.5 in.	Vinyl	100/pk.
60195	1 in. x 1 in.	Vinyl	100/pk.
60206	2 in. x 2 in.	Vinyl	100/pk.
60217	4 in. x 4 in.	Vinyl	30/pk.
60228	8 in. x 8 in.	Vinyl	10/pk.



Battery Hazard

60186	0.5 in. x 0.5 in.	Vinyl	100/pk.
60197	1 in. x 1 in.	Vinyl	100/pk.
60208	2 in. x 2 in.	Vinyl	100/pk.
60219	4 in. x 4 in.	Vinyl	30/pk.
60230	8 in. x 8 in.	Vinyl	10/pk.



Electrical Voltage

60235	0.5 in. x 0.5 in.	Vinyl	100/pk.
60191	1 in. x 1 in.	Vinyl	100/pk.
60202	2 in. x 2 in.	Vinyl	100/pk.
60213	4 in. x 4 in.	Vinyl	30/pk.
60224	8 in. x 8 in.	Vinyl	10/pk.



Explosive Atmosphere

60189	0.5 in. x 0.5 in.	Vinyl	100/pk.
60200	1 in. x 1 in.	Vinyl	100/pk.
60211	2 in. x 2 in.	Vinyl	100/pk.
60222	4 in. x 4 in.	Vinyl	30/pk.
60233	8 in. x 8 in.	Vinyl	10/pk.



Explosive Material

60182	0.5 in. x 0.5 in.	Vinyl	100/pk.
60193	1 in. x 1 in.	Vinyl	100/pk.
60204	2 in. x 2 in.	Vinyl	100/pk.
60215	4 in. x 4 in.	Vinyl	30/pk.
60226	8 in. x 8 in.	Vinyl	10/pk.



Flammable Material

60181	0.5 in. x 0.5 in.	Vinyl	100/pk.
60192	1 in. x 1 in.	Vinyl	100/pk.
60203	2 in. x 2 in.	Vinyl	100/pk.
60214	4 in. x 4 in.	Vinyl	30/pk.
60225	8 in. x 8 in.	Vinyl	10/pk.



Hazardous Area

60188	0.5 in. x 0.5 in.	Vinyl	100/pk.
60199	1 in. x 1 in.	Vinyl	100/pk.
60210	2 in. x 2 in.	Vinyl	100/pk.
60221	4 in. x 4 in.	Vinyl	30/pk.
60232	8 in. x 8 in.	Vinyl	10/pk.



Laser Beam

60187	0.5 in. x 0.5 in.	Vinyl	100/pk.
60198	1 in. x 1 in.	Vinyl	100/pk.
60209	2 in. x 2 in.	Vinyl	100/pk.
60220	4 in. x 4 in.	Vinyl	30/pk.
60231	8 in. x 8 in.	Vinyl	10/pk.



Radioactive Material

60185	0.5 in. x 0.5 in.	Vinyl	100/pk.
60196	1 in. x 1 in.	Vinyl	100/pk.
60207	2 in. x 2 in.	Vinyl	100/pk.
60218	4 in. x 4 in.	Vinyl	30/pk.
60229	8 in. x 8 in.	Vinyl	10/pk.



Static Sensitive Devices

60190	0.5 in. x 0.5 in.	Vinyl	100/pk.
60201	1 in. x 1 in.	Vinyl	100/pk.
60212	2 in. x 2 in.	Vinyl	100/pk.
60223	4 in. x 4 in.	Vinyl	30/pk.
60234	8 in. x 8 in.	Vinyl	10/pk.



Toxic Material

60183	0.5 in. x 0.5 in.	Vinyl	100/pk.
60194	1 in. x 1 in.	Vinyl	100/pk.
60205	2 in. x 2 in.	Vinyl	100/pk.
60216	4 in. x 4 in.	Vinyl	30/pk.
60227	8 in. x 8 in.	Vinyl	10/pk.



Porta-Pack® Voltage Labels

- Voltage labels mounted on pocket-sized flip strip cards so they are easy to carry and always on hand when needed
- Made of self-sticking vinyl material

Catalog #	Legend	Size	Quantity
44500	120 Volts	0.562 in. x 3.250 in.	3 labels/card; 5 cards/pack
44501	240 Volts	0.562 in. x 3.250 in.	3 labels/card; 5 cards/pack
44503	480 Volts	0.562 in. x 3.250 in.	3 labels/card; 5 cards/pack

Mr. Ouch Transformer Labels

- National Electrical Manufacturers Association (NEMA) recommends use on transformers located in public areas
- Meet the NEMA Standard as well as Underwriters Laboratory Performance Standard #969
- Made of B-927 tamper-resistant film



46346 8 in. x 4.5 in. 1 ea.



46347 8 in. x 4.5 in. 1 ea.



46348 4.5 in. x 10.75 in. 1 ea.



46349 4.5 in. x 10.75 in. 1 ea.

CEMA Conveyor Safety Labels

- Conveyor Equipment Safety Labels help make your conveying equipment operations safer
- Made of B-302 high-performance polyester



96175 6 in. x 3 in. 5/pk.



96179 6 in. x 3 in. 5/pk.



96177 6 in. x 3 in. 5/pk.



96180 6 in. x 3 in. 5/pk.



96178 6 in. x 3 in. 5/pk.



96160 2.5 in. x 5 in. 5/pk.

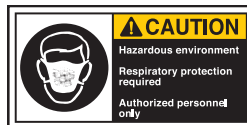

96168 2.5 in. x 5 in. 5/pk.



96167 2.5 in. x 5 in. 5/pk.



96171 2.5 in. x 5 in. 5/pk.



96162 2.5 in. x 5 in. 5/pk.



96158 2.5 in. x 5 in. 5/pk.



96157 2.5 in. x 5 in. 5/pk.



96170 2.5 in. x 5 in. 5/pk.



96156 2.5 in. x 5 in. 5/pk.



96164 2.5 in. x 5 in. 5/pk.



96155 2.5 in. x 5 in. 5/pk.



96165 2.5 in. x 5 in. 5/pk.



96159 2.5 in. x 5 in. 5/pk.



96163 2.5 in. x 5 in. 5/pk.



96173 2.5 in. x 5 in. 5/pk.

Pre-Printed Labels

BradyID.com/s36

Quality Control Labels

- Identify the calibration, testing and repair of tools and equipment
- Material options include B-500 repositionable vinyl cloth, B-619 permanent polyester and B-184 aluminum foil tape
- Standard package is 1 card. Value pack (VP) is 5 cards. Bulk pack (PK) is 25 cards



(BLANK)

B-500 repositionable vinyl cloth

WO-47	0.250 x 0.75 in.	Vinyl	72 labels
WO-47-PK	0.250 x 0.75 in.	Vinyl	1800 labels
WO-46	0.250 x 1.50 in.	Vinyl	36 labels
WO-46-VP	0.250 x 1.50 in.	Vinyl	180 labels
WO-46-PK	0.250 x 1.50 in.	Vinyl	900 labels
WO-35	0.343 x 1.50 in.	Vinyl	25 labels
WO-35-PK	0.343 x 1.50 in.	Vinyl	625 labels
WO-30	0.437 x 1.50 in.	Vinyl	20 labels
WO-30-PK	0.437 x 1.50 in.	Vinyl	500 labels
WO-48	0.500 x 0.50 in.	Vinyl	54 labels
WO-49	0.500 x 1.50 in.	Vinyl	18 labels
WO-49-PK	0.500 x 1.50 in.	Vinyl	450 labels
WO-68	0.500 x 2.25 in.	Vinyl	18 labels
WO-24	0.625 x 1.50 in.	Vinyl	14 labels
WO-24-PK	0.625 x 1.50 in.	Vinyl	350 labels
WO-50	0.750 x 0.50 in.	Vinyl	36 labels
WO-50-PK	0.750 x 0.50 in.	Vinyl	900 labels
WO-62	0.750 x 2.25 in.	Vinyl	12 labels
WO-62-VP	0.750 x 2.25 in.	Vinyl	60 labels
WO-59	1.000 x 1.50 in.	Vinyl	9 labels
WO-59-PK	1.000 x 1.50 in.	Vinyl	225 labels
WO-19	1.500 x 1.00 in.	Vinyl	9 labels
WO-19-VP	1.500 x 1.00 in.	Vinyl	45 labels
WO-19-PK	1.500 x 1.00 in.	Vinyl	225 labels
WO-16	1.500 x 1.50 in.	Vinyl	6 labels
WO-56	2.250 x 1.50 in.	Vinyl	6 labels
WO-56-PK	2.250 x 1.50 in.	Vinyl	150 labels
WO-54	2.250 x 2.25 in.	Vinyl	4 labels
WO-54-PK	2.250 x 2.25 in.	Vinyl	100 labels

B-619 permanent polyester

WOX-47	0.250 x 0.75 in.	Poly.	72 labels
WOX-46	0.250 x 1.50 in.	Poly.	36 labels
WOX-49	0.500 x 1.50 in.	Poly.	18 labels
WOX-24	0.625 x 1.50 in.	Poly.	14 labels

B-184 aluminum foil tape

WOAF-46	0.250 x 1.50 in.	Alum.	36 labels
WOAF-30	0.437 x 1.50 in.	Alum.	20 labels
WOAF-30-PK	0.437 x 1.50 in.	Alum.	500 labels
WOAF-24	0.625 x 1.50 in.	Alum.	14 labels
WOAF-19	1.500 x 1.00 in.	Alum.	9 labels

ACCEPTED

BY _____ DATE _____

WO-2	0.625 x 1.5 in.	Vinyl	14 labels
WO-2-PK	0.625 x 1.5 in.	Vinyl	350 labels
WOX-2	0.625 x 1.5 in.	Poly.	14 labels
WOX-2-PK	0.625 x 1.5 in.	Poly.	350 labels
WOAF-2	0.625 x 1.5 in.	Alum.	14 labels

CALIBRATION

BY _____ DATE _____

DUE _____

WO-10	0.625 x 1.5 in.	Vinyl	14 labels
WO-10-VP	0.625 x 1.5 in.	Vinyl	70 labels
WO-10-PK	0.625 x 1.5 in.	Vinyl	350 labels
WOX-10	0.625 x 1.5 in.	Poly.	14 labels
WOX-10-PK	0.625 x 1.5 in.	Poly.	350 labels
WOAF-10	0.625 x 1.5 in.	Alum.	14 labels
WOAF-10-PK	0.625 x 1.5 in.	Alum.	350 labels

CALIBRATION DATE _____

BY _____

DUE _____

WO-9	1.0 x 1.5 in.	Vinyl	9 labels
WO-9-PK	1.0 x 1.5 in.	Vinyl	225 labels
WOX-9	1.0 x 1.5 in.	Poly.	9 labels
WOX-9-PK	1.0 x 1.5 in.	Poly.	225 labels
WOAF-9	1.0 x 1.5 in.	Alum.	9 labels
WOAF-9-PK	1.0 x 1.5 in.	Alum.	225 labels

BATCH NO. _____ **DATE** _____

WO-7	0.625 x 1.5 in.	Vinyl	14 labels
------	-----------------	-------	-----------

CALIBRATION DATE _____

BY _____ DUE _____

INST. I.D. _____

WO-64	0.625 x 1.5 in.	Vinyl	14 labels
WO-64-PK	0.625 x 1.5 in.	Vinyl	350 labels

CALIBRATED

BY _____ DATE _____

DUE _____

WO-41	0.625 x 1.5 in.	Vinyl	14 labels
WO-41-PK	0.625 x 1.5 in.	Vinyl	350 labels

CALIBRATED

EXPIRES _____

IDENT. NO. _____

ACCURACY _____

DATE CAL. _____

BY _____

DEPT. NO. _____

WO-63	0.5 x 1.50 in.	Vinyl	6 labels
-------	----------------	-------	----------

CALIBRATION NOT REQUIRED

WO-53	0.5 x 1.5 in.	Vinyl	18 labels
WO-53-PK	0.5 x 1.5 in.	Vinyl	450 labels
WOAF-53	0.5 x 1.5 in.	Alum.	18 labels
WOAF-53-PK	0.5 x 1.5 in.	Alum.	450 labels

CAUTION

WO-11	0.625 x 1.5 in.	Vinyl	14 labels
WO-11-PK	0.625 x 1.5 in.	Vinyl	350 labels

CERTIFICATION

BY _____ DATE _____

DUE _____

WO-42	0.625 x 1.5 in.	Vinyl	14 labels
WO-42-PK	0.625 x 1.5 in.	Vinyl	350 labels

CIRCUIT NO.

LOCATION _____

WO-14	0.625 x 1.5 in.	Vinyl	14 labels
-------	-----------------	-------	-----------

DATE INSTALLED

BY _____

WO-17	0.625 x 1.5 in.	Vinyl	14 labels
WO-17-PK	0.625 x 1.5 in.	Vinyl	350 labels

DO NOT USE

AFTER _____

WO-18	0.625 x 1.5 in.	Vinyl	14 labels
WO-18-PK	0.625 x 1.5 in.	Vinyl	350 labels
WOX-18	0.625 x 1.5 in.	Poly.	14 labels
WOX-18-PK	0.625 x 1.5 in.	Poly.	350 labels
WOAF-18	0.625 x 1.5 in.	Alum.	14 labels

DO NOT USE

Until Tested & Calibrated

WO-51	0.625 x 1.5 in.	Vinyl	14 labels
WO-51-PK	0.625 x 1.5 in.	Vinyl	350 labels

DUE FOR INSPECTION

DO NOT REMOVE

WO-20	0.625 x 1.5 in.	Vinyl	14 labels
WO-20-PK	0.625 x 1.5 in.	Vinyl	350 labels

EXTINGUISHER

CHECKED ON _____

DATE _____ BY _____

WOX-23	0.625 x 1.5 in.	Poly.	14 labels
--------	-----------------	-------	-----------

HOLD

FOR _____

UNTIL _____

WO-3	0.625 x 1.5 in.	Vinyl	14 labels
------	-----------------	-------	-----------

Pre-Printed Labels

HOLD FOR INSPECTION	
BY _____	DATE _____
REASON _____	

WO-6 0.625 x 1.5 in. Vinyl 14 labels

INSPECTED BY:	
DATE _____	

WO-52 0.625 x 1.5 in. Vinyl 14 labels
WO-52-VP 0.625 x 1.5 in. Vinyl 70 labels
WO-52-PK 0.625 x 1.5 in. Vinyl 350 labels

INVENTORY	
NO: _____	DATE: _____
COUNT: _____	BY: _____

WO-27 1.0 x 1.5 in. Vinyl 9 labels

MAINTENANCE	
BY: _____	DATE: _____

WO-43 0.625 x 1.5 in. Vinyl 14 labels
WO-43-PK 0.625 x 1.5 in. Vinyl 350 labels

PROPERTY TAG	
ASSET NO. _____	

WOAF-29 0.5 x 1.5 in. Alum. 18 labels
WOAF-29-VP 0.5 x 1.5 in. Alum. 90 labels
WOAF-29-PK 0.5 x 1.5 in. Alum. 450 labels

RE-WORK	DATE
BY: _____	_____
REASON: _____	_____

WO-5 0.625 x 1.5 in. Vinyl 14 labels
WO-5-PK 0.625 x 1.5 in. Vinyl 350 labels
WOX-5 0.625 x 1.5 in. Poly. 14 labels

REJECTED	DATE
REASON _____	_____
BY _____	_____

WO-1 0.625 x 1.5 in. Vinyl 14 labels
WO-1-PK 0.625 x 1.5 in. Vinyl 350 labels
WOX-1 0.625 x 1.5 in. Poly. 14 labels

REPAIRED BY	
INITIALS _____	_____
DATE _____	_____

WO-31 0.625 x 1.5 in. Vinyl 14 labels
WO-31-PK 0.625 x 1.5 in. Vinyl 350 labels
WOX-31 0.625 x 1.5 in. Poly. 14 labels

RETURN TO VENDOR	
BY _____	DATE _____
REASON _____	

WO-4 0.625 x 1.5 in. Vinyl 14 labels

REV.

WOX-57 0.75 x 0.25 Poly. 72 labels

SCRAPPED
DATE _____
INITIALS _____

WO-33 0.625 x 1.5 in. Vinyl 14 labels

STOCK NO.

WO-37 0.5 x 1.5 in. Vinyl 18 labels
WO-37-PK 0.5 x 1.5 in. Vinyl 450 labels

SERIAL NO.			

MODEL NO.			

VOLTS	AC-DC	AMPS	HERTZ
_____	_____	_____	_____

WOAF-36 2.25 x 1.5 in. Alum. 6 labels
WOAF-36-VP 2.25 x 1.5 in. Alum. 30 labels
WOAF-36-PK 2.25 x 1.5 in. Alum. 150 labels

SERIAL NO.

WO-34 0.5 x 1.5 in. Vinyl 18 labels
WO-34-PK 0.5 x 1.5 in. Vinyl 450 labels
WOAF-34 0.5 x 1.5 in. Alum. 18 labels
WOAF-34-PK 0.5 x 1.5 in. Alum. 450 labels

TESTED	
DATE _____	INITIALS _____

WO-38 0.625 x 1.5 in. Vinyl 14 labels
WO-38-PK 0.625 x 1.5 in. Vinyl 350 labels
WOX-38 0.625 x 1.5 in. Poly. 14 labels
WOX-38-PK 0.625 x 1.5 in. Poly. 350 labels
WOAF-38 0.625 x 1.5 in. Alum. 14 labels
WOAF-38-PK 0.625 x 1.5 in. Alum. 350 labels

TOOL NO.	DEPT.
_____	_____

WO-39 0.625 x 1.5 in. Poly. 14 labels

Bilingual Labels

- Labels feature English and Spanish legends
- Made of B-500 repositionable vinyl cloth
- Standard package is 1 card

CALIBRATED CALIBRADO	
BY POR _____	DATE FECHA _____
DUE DEBIDO _____	_____

WOS-41 0.625 x 1.5 in. Vinyl 14/card

CALIBRATION CALIBRACION	
BY POR _____	DATE FECHA _____
DUE DEBIDO _____	_____

WOS-10 0.625 x 1.5 in. Vinyl 14/card

REJECTED RECHAZADO	
BY POR _____	DATE FECHA _____
REASON RAZON _____	_____

WOS-1 0.625 x 1.5 in. Vinyl 14/card



Write-On Inspection Labels

- Made of durable, write-on polyester
- 364 identical labels per package

ACCEPTED	
DATE _____	INITIALS _____

82586 0.625 x 1.5 in. 364/pk.

CALIBRATED	
BY _____	DATE _____
DUE FOR CAL. _____	

82589 0.625 x 1.5 in. 364/pk.

CALIBRATED	
BY _____	DATE _____
DUE FOR CAL. _____	

82592 0.625 x 1.5 in. 364/pk.

CALIBRATION	
BY _____	DATE _____
NEXT CAL. DUE _____	_____
INSTRUMENT# _____	_____

42211 0.625 x 1.5 in. 364/pk.

CALIBRATION NOT REQUIRED	
--------------------------	--

82594 0.625 x 1.5 in. 364/pk.

CERTIFICATION	
BY _____	DATE _____
DUE _____	

42217 0.625 x 1.5 in. 364/pk.

DO NOT USE AFTER	
DATE _____	

82590 0.625 x 1.5 in. 364/pk.

INSPECTED	
DATE _____	INITIALS _____

82587 0.625 x 1.5 in. 364/pk.

MAINTENANCE	
BY _____	DATE _____
DATE _____	_____

42221 0.625 x 1.5 in. 364/pk.

REJECTED	
BY _____	DATE _____

82591 0.625 x 1.5 in. 364/pk.

REPAIRED BY	
INITIALS _____	_____
DATE _____	_____

82593 0.625 x 1.5 in. 364/pk.

TESTED	
DATE _____	INITIALS _____

82588 0.625 x 1.5 in. 364/pk.

Pre-Printed Labels

BradyID.com/s36

Machine and Equipment Labels

- Labels communicate dangers and messages to those close to or working around machinery and equipment
- Place these small labels on equipment to increase safety
- Made of B-302 self-sticking polyester



868271 3.5 x 5 in. Poly. 5/pk.



86864 3.5 x 5 in. Poly. 5/pk.

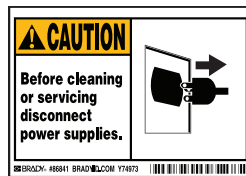

86841 3.5 x 5 in. Poly. 5/pk.



86842 3.5 x 5 in. Poly. 5/pk.



86843 3.5 x 5 in. Poly. 5/pk.



86844 3.5 x 5 in. Poly. 5/pk.



86846 3.5 x 5 in. Poly. 5/pk.



86889 3.5 x 5 in. Poly. 5/pk.

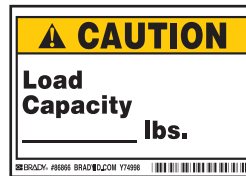

86866 3.5 x 5 in. Poly. 5/pk.

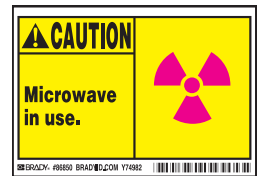

86850 3.5 x 5 in. Poly. 5/pk.

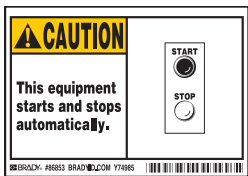

86853 3.5 x 5 in. Poly. 5/pk.

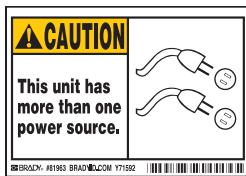

81963 3.5 x 5 in. Poly. 5/pk.



86857 3.5 x 5 in. Poly. 5/pk.



86260 3.5 x 5 in. Poly. 5/pk.

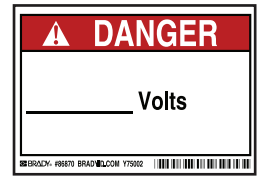

86870 3.5 x 5 in. Poly. 5/pk.

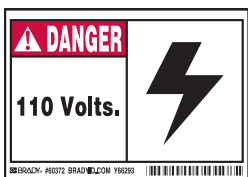

86372 3.5 x 5 in. Poly. 5/pk.

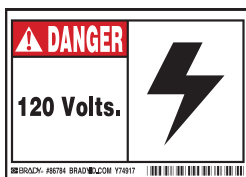

86784 3.5 x 5 in. Poly. 5/pk.

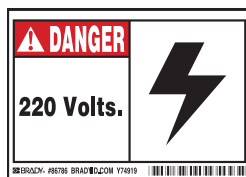

86786 3.5 x 5 in. Poly. 5/pk.

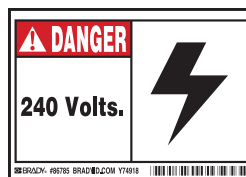

86785 3.5 x 5 in. Poly. 5/pk.

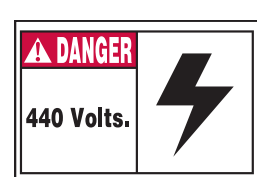

86373 3.5 x 5 in. Poly. 5/pk.

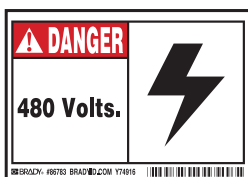

86783 3.5 x 5 in. Poly. 5/pk.

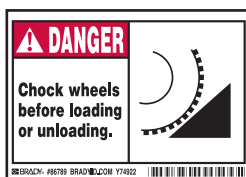

86789 3.5 x 5 in. Poly. 5/pk.



86895 3.5 x 5 in. Poly. 5/pk.



86898 3.5 x 5 in. Poly. 5/pk.

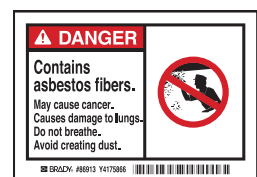

86913 3.5 x 5 in. Poly. 5/pk.

Pre-Printed Labels

Stock Spanish Labels Available

Contact Brady Customer Service to order.



86847 3.5 x 5 in. Poly. 5/pk.



86235 5 x 3.5 in. Poly. 5/pk.



86234 5 x 3.5 in. Poly. 5/pk.



86792 3.5 x 5 in. Poly. 5/pk.

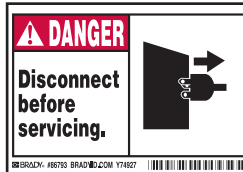

86793 3.5 x 5 in. Poly. 5/pk.



86882 3.5 x 5 in. Poly. 5/pk.



86796 3.5 x 5 in. Poly. 5/pk.



86797 3.5 x 5 in. Poly. 5/pk.



86869 3.5 x 5 in. Poly. 5/pk.



86899 3.5 x 5 in. Poly. 5/pk.

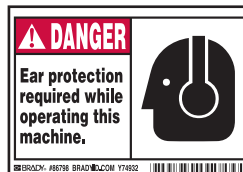

86798 3.5 x 5 in. Poly. 5/pk.



86799 3.5 x 5 in. Poly. 5/pk.



86801 3.5 x 5 in. Poly. 5/pk.

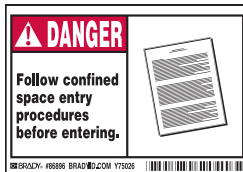

86896 3.5 x 5 in. Poly. 5/pk.



86804 3.5 x 5 in. Poly. 5/pk.

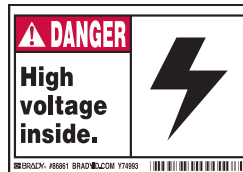

86861 3.5 x 5 in. Poly. 5/pk.

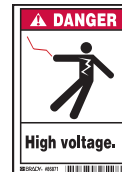

86871 5 x 3.5 in. Poly. 5/pk.



86860 3.5 x 5 in. Poly. 5/pk.



86877 5 x 3.5 in. Poly. 5/pk.



86862 3.5 x 5 in. Poly. 5/pk.



86808 3.5 x 5 in. Poly. 5/pk.



86811 3.5 x 5 in. Poly. 5/pk.



86891 3.5 x 5 in. Poly. 5/pk.



86886 5 x 3.5 in. Poly. 5/pk.



86894 3.5 x 5 in. Poly. 5/pk.



86874 3.5 x 5 in. Poly. 5/pk.



86885 3.5 x 5 in. Poly. 5/pk.

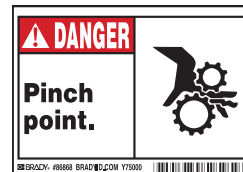

86868 3.5 x 5 in. Poly. 5/pk.



86867 3.5 x 5 in. Poly. 5/pk.



86813 3.5 x 5 in. Poly. 5/pk.

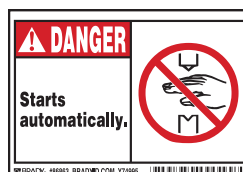

86863 3.5 x 5 in. Poly. 5/pk.



86148 3.5 x 5 in. Poly. 5/pk.



86817 3.5 x 5 in. Poly. 5/pk.

Pre-Printed Labels

BradyID.com/s36

Machine and Equipment Labels (continued)



86887 5 x 3.5 in. Poly. 5/pk.



86818 3.5 x 5 in. Poly. 5/pk.



86865 3.5 x 5 in. Poly. 5/pk.



86248 3.5 x 5 in. Poly. 5/pk.



86250 3.5 x 5 in. Poly. 5/pk.



86194 3.5 x 5 in. Poly. 5/pk.



86905 3.5 x 5 in. Poly. 5/pk.



86859 3.5 x 5 in. Poly. 5/pk.



86193 3.5 x 5 in. Poly. 5/pk.



86909 3.5 x 5 in. Poly. 5/pk.



86890 3.5 x 5 in. Poly. 5/pk.

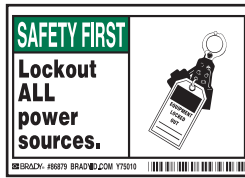

86879 3.5 x 5 in. Poly. 5/pk.



86302 3.5 x 5 in. Poly. 5/pk.



86880 3.5 x 5 in. Poly. 5/pk.



86900 3.5 x 5 in. Poly. 5/pk.



86901 3.5 x 5 in. Poly. 5/pk.



86826 3.5 x 5 in. Poly. 5/pk.



86828 3.5 x 5 in. Poly. 5/pk.



86830 3.5 x 5 in. Poly. 5/pk.



86832 3.5 x 5 in. Poly. 5/pk.



86878 3.5 x 5 in. Poly. 5/pk.

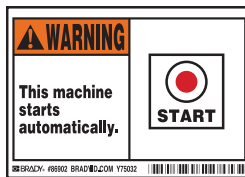

86902 3.5 x 5 in. Poly. 5/pk.



86837 3.5 x 5 in. Poly. 5/pk.



86903 3.5 x 5 in. Poly. 5/pk.



86838 3.5 x 5 in. Poly. 5/pk.



86839 3.5 x 5 in. Poly. 5/pk.



86266 5 x 3.5 in. Poly. 5/pk.



86243 3.5 x 5 in. Poly. 5/pk.

Pre-Printed Labels

Machine and Equipment Labels (continued)

 <p>86199 3.5 x 5 in. Poly. 5/pk.</p>	 <p>86218 3.5 x 5 in. Poly. 5/pk.</p>	 <p>86203 3.5 x 5 in. Poly. 5/pk.</p>	 <p>86246 3.5 x 5 in. Poly. 5/pk.</p>	 <p>86198 3.5 x 5 in. Poly. 5/pk.</p>
 <p>86275 3.5 x 5 in. Poly. 5/pk.</p>	 <p>86270 3.5 x 5 in. Poly. 5/pk.</p>	 <p>86261 3.5 x 5 in. Poly. 5/pk.</p>	 <p>86245 3.5 x 5 in. Poly. 5/pk.</p>	 <p>86204 3.5 x 5 in. Poly. 5/pk.</p>
 <p>86216 3.5 x 5 in. Poly. 5/pk.</p>	 <p>86240 5 x 3.5 in. Poly. 5/pk.</p>	 <p>86213 3.5 x 5 in. Poly. 5/pk.</p>	 <p>86267 5 x 3.5 in. Poly. 5/pk.</p>	 <p>86225 3.5 x 5 in. Poly. 5/pk.</p>

Gas Cylinder Labels

- Promote safety and safe handling of gas cylinders by posting these labels around cylinders and cylinder storage areas
- Labels remove cleanly, leaving no residue on surface
- Made of B-235 self-adhesive paper

 <p>60311 3 x 5 in. Paper 10/pk.</p>	 <p>60312 3 x 5 in. Paper 10/pk.</p>	 <p>60309 3 x 5 in. Paper 10/pk.</p>	 <p>60313 3 x 5 in. Paper 10/pk.</p>	 <p>60310 3 x 5 in. Paper 10/pk.</p>
 <p>60314 3 x 5 in. Paper 10/pk.</p>	 <p>60307 3 x 5 in. Paper 10/pk.</p>	 <p>60308 3 x 5 in. Paper 10/pk.</p>	 <p>60315 3 x 5 in. Paper 10/pk.</p>	

Pre-Printed Labels

BradyID.com/s36

Cabinet Labels

- Clearly identify cabinets containing chemicals and safety equipment
- Specially designed for placement on any size cabinet, including one-door and low-capacity cabinets
- Made of B-302 self-adhesive laminated polyester



60284 3.5 x 12 in. Polyester 1 ea.
60261 7 x 24 in. Polyester 1 ea.



60285 3.5 x 12 in. Polyester 1 ea.
60262 7 x 24 in. Polyester 1 ea.



60286 3.5 x 12 in. Polyester 1 ea.
60263 7 x 24 in. Polyester 1 ea.



60287 3.5 x 12 in. Polyester 1 ea.
60264 7 x 24 in. Polyester 1 ea.



60288 3.5 x 12 in. Polyester 1 ea.
60265 7 x 24 in. Polyester 1 ea.



60289 3.5 x 12 in. Polyester 1 ea.
60266 7 x 24 in. Polyester 1 ea.



60290 3.5 x 12 in. Polyester 1 ea.
60267 7 x 24 in. Polyester 1 ea.



60291 3.5 x 12 in. Polyester 1 ea.
60268 7 x 24 in. Polyester 1 ea.



60292 3.5 x 12 in. Polyester 1 ea.
60269 7 x 24 in. Polyester 1 ea.



60294 3.5 x 12 in. Polyester 1 ea.
60271 7 x 24 in. Polyester 1 ea.



60295 3.5 x 12 in. Polyester 1 ea.
60272 7 x 24 in. Polyester 1 ea.



60296 3.5 x 12 in. Polyester 1 ea.
60273 7 x 24 in. Polyester 1 ea.



60297 3.5 x 12 in. Polyester 1 ea.
60274 7 x 24 in. Polyester 1 ea.



60298 3.5 x 12 in. Polyester 1 ea.
60275 7 x 24 in. Polyester 1 ea.



60299 3.5 x 12 in. Polyester 1 ea.
60276 7 x 24 in. Polyester 1 ea.



60300 3.5 x 12 in. Polyester 1 ea.
60277 7 x 24 in. Polyester 1 ea.



60301 3.5 x 12 in. Polyester 1 ea.
60278 7 x 24 in. Polyester 1 ea.



60302 3.5 x 12 in. Polyester 1 ea.
60279 7 x 24 in. Polyester 1 ea.



60303 3.5 x 12 in. Polyester 1 ea.
60280 7 x 24 in. Polyester 1 ea.



60293 3.5 x 12 in. Polyester 1 ea.
60270 7 x 24 in. Polyester 1 ea.



60304 3.5 x 12 in. Polyester 1 ea.
60281 7 x 24 in. Polyester 1 ea.



60305 3.5 x 12 in. Polyester 1 ea.
60282 7 x 24 in. Polyester 1 ea.



60306 3.5 x 12 in. Polyester 1 ea.
60283 7 x 24 in. Polyester 1 ea.

Pre-Printed Labels

Container Labels

- Bold pre-printed labels leave no doubt as to the contents of containers
- Self-adhesive polyester labels are constructed from laminated polyester
- Chemical resistant for longer label life



60243 3 x 7 in. 25/pk.	60244 3 x 7 in. 25/pk.	60245 3 x 7 in. 25/pk.	60246 3 x 7 in. 25/pk.	60247 3 x 7 in. 25/pk.	60248 3 x 7 in. 25/pk.
60249 3 x 7 in. 25/pk.	60250 3 x 7 in. 25/pk.	60251 3 x 7 in. 25/pk.	60252 3 x 7 in. 25/pk.	60253 3 x 7 in. 25/pk.	60254 3 x 7 in. 25/pk.
60255 3 x 7 in. 25/pk.	60256 3 x 7 in. 25/pk.	60257 3 x 7 in. 25/pk.	60258 3 x 7 in. 25/pk.	60259 3 x 7 in. 25/pk.	60260 3 x 7 in. 25/pk.

Fire Extinguisher Labels

- Fire extinguisher labels use the most recently recommended pictorial design from NAFED (National Association of Fire Equipment Distributors)
- Label style meets the NFPA 10, 1084 standard for portable fire extinguishers labels

45193 1.5 x 1.5 in. B-927 6/card 95218 3 x 3 in. B-927 3/card	45194 1.5 x 1.5 in. B-927 6/card 95219 3 x 3 in. B-927 3/card	45195 1.5 x 1.5 in. B-927 6/card 95220 3 x 3 in. B-927 3/card	45196 1.5 x 1.5 in. B-927 6/card 95221 3 x 3 in. B-927 3/card
95222 1.5 x 6 in. B-927 6/card	95223 1.5 x 6 in. B-927 6/card	95224 1.5 x 6 in. B-927 6/card	95225 1.5 x 6 in. B-927 6/card
95226 1.5 x 6 in. B-927 6/card	95227 1.5 x 6 in. B-927 6/card	95228 1.5 x 6 in. B-927 6/card	76303 1.5 x 3 in. B-927 3/card
A extinguishers, water based 76299 2 x 5 in. B-927 5/card	A/B extinguishers, AFFF, foam 76300 2 x 5 in. B-927 5/card	B/C extinguishers, carbon dioxide, halon 1211 and 1301, dry chemical 76301 2 x 5 in. B-927 5/card	A/B/C extinguishers, halon 1211, multi-purpose dry chemical 76302 2 x 5 in. B-927 5/card

Pre-Printed Labels

BradyID.com/s36

Hard Hat Emblems

- Provide a constant visual reminder to observe good safety practices
- Emblems may also be used to identify first aid personnel.
- 2 in. diameter indoor / outdoor vinyl labels and are card-mounted
- Glow-in-the-dark labels sold 1 per card, non glow-in-the-dark sold 4 per card



49551	49550	102027 Glow - 1/pk.	49574	42229	42228	49554			
49576	42230	42231	42293	49560	49565	102030 Glow - 1/pk.	42233	49562	
49567	49568	49561	42234	42294	49580	49570	42238	49556	
49579	45332	76306	42241	42242	42243	49563	49578	49558	
42244	42245	49569	42247	42248	49559	76305	42257	49571	
42262	42263	42261	49566	42541	49557	49577	49553	49552	
49555	42269	45330	102024 Glow - 1/pk.	49581	102026 Glow - 1/pk.	42272	42271	42273	
49572	49573	49564	42283	42284	45333	45331	102025 Glow - 1/pk.	42290	

Pre-Printed Labels



Reflective Hard Hat Labels

- Made of silver-reflective, pressure-sensitive vinyl so they are easy to read even in low-light conditions

Catalog #	Legend	Size	Qty.
28713	Chief	3 in. x 6.875 in.	1
28714	Emergency Medical Technician	3 in. x 6.875 in.	1
28720	Safety Officers	3 in. x 6.875 in.	1



Reflective Hard Hat Stripes

- (50) 1.25 in. x 5 in. stripes per package

Catalog #	Description	Qty.
95229	1.25 in. x 5 in.	50



Write-On Magnetic Labels

- Re-useable labels with a water-soluble pen that wipes off with a wet cloth
- For a permanent label, use our permanent marking pen (87052)

Catalog #	Size	Color	Qty.
56957	1 in. x 50 ft.	Blue	1 roll
56958	1 in. x 50 ft.	Green	1 roll
56959	1 in. x 50 ft.	Orange	1 roll
56960	1 in. x 50 ft.	Red	1 roll
56961	1 in. x 50 ft.	White	1 roll
56962	1 in. x 50 ft.	Yellow	1 roll



Gauge Marking Labels

- Color code your gauges to easily identify acceptable or dangerous levels
- Transparent, adhesive polyester label sheets

Catalog #	Description	Color	Qty.
30697	9 in. x 10 in. sheet	Red	1
30698	9 in. x 10 in. sheet	Green	1
30699	9 in. x 10 in. sheet	Yellow	1

Print-Your-Own Labels

Benchtop and portable printers offer you the opportunity to make custom labels on-demand. No need to wait for custom labels to arrive, simply print your own labels at the point of need.



For more information view:
Benchtop printers..... page 26
Portable printers..... page 102



Numbers and Letters

BradyID.com/s36

ToughStripe® Floor Marking Numbers and Letters

- Easy to view 6 in. x 8 in. numbers and letters are ideal for marking aisle-ways, shipping and receiving docks, distribution centers or other areas in your facility
- Material removes cleanly without any unsightly adhesive residue or damage to the floor



	Black 20/pk.	White 20/pk.	Red 20/pk.	Green 20/pk.	Blue 20/pk.	Yellow 20/pk.
0	121847	121848	121849	121850	121851	121852
1	121853	121854	121855	121856	121857	121858
2	121859	121860	121861	121862	121863	121864
3	121865	121866	121867	121868	121869	121870
4	121871	121872	121873	121874	121875	121876
5	121877	121878	121879	121880	121881	121882
6	121883	121884	121885	121886	121887	121888
7	121889	121890	121891	121892	121893	121894
8	121895	121896	121897	121898	121899	121900
9	121901	121902	121903	121904	121905	121906
A	121691	121692	121693	121694	121695	121696
B	121697	121698	121699	121700	121701	121702
C	121703	121704	121705	121706	121707	121708
D	121709	121710	121711	121712	121713	121714
E	121715	121716	121717	121718	121719	121720
F	121721	121722	121723	121724	121725	121726
G	121727	121728	121729	121730	121731	121732
H	121733	121734	121735	121736	121737	121738
I	121739	121740	121741	121742	121743	121744
J	121745	121746	121747	121748	121749	121750

	Black 20/pk.	White 20/pk.	Red 20/pk.	Green 20/pk.	Blue 20/pk.	Yellow 20/pk.
K	121751	121752	121753	121754	121755	121756
L	121757	121758	121759	121760	121761	121762
M	121763	121764	121765	121766	121767	121768
N	121769	121770	121771	121772	121773	121774
O	121775	121776	121777	121778	121779	121780
P	121781	121782	121783	121784	121785	121786
Q	121787	121788	121789	121790	121791	121792
R	121793	121794	121795	121796	121797	121798
S	121799	121800	121801	121802	121803	121804
T	121805	121806	121807	121808	121809	121810
U	121811	121812	121813	121814	121815	121816
V	121817	121818	121819	121820	121821	121822
W	121823	121824	121825	121826	121827	121828
X	121829	121830	121831	121832	121833	121834
Y	121835	121836	121837	121838	121839	121840
Z	121841	121842	121843	121844	121845	121846
Punct. Set*	121907	121908	121909	121910	121911	121912

* Each set includes: 40 periods, 20 commas, 20 question marks, 20 exclamation points, 20 forward slashes, 20 dashes and 20 ampersands.



Number and Letter Labels

15 Series Outdoor Numbers and Letters

- B-946 premium outdoor grade vinyl with permanent pressure sensitive adhesive
- Designed for permanent applications in severe outdoor environments as well as indoors
- Special acrylic adhesive adheres strongly, making marker removal difficult



15 Series Individual Cards

- Sold as individual cards

Catalog #	Character Height	Marker Size	Markers Per Card
Available in letters (A-Z), dashes (DSH) only			
1500-*	0.25 in.	0.375 in. x 0.25 in.	144
Available in numbers (0-9), letters (A-Z), dashes (DSH) and arrows (ARO).			
1520-*	0.625 in.	0.75 in. x 0.562 in.	32
1530-*	1 in.	1.5 in. x 0.875 in.	10
1534-*	2 in.	2.25 in. x 0.875 in.	10
1550-*	3 in.	3.5 in. x 1.5 in.	6
Available in numbers (0-9), letters (A-Z), dashes (DSH)			
1560-*	3.875 in.	5 in. x 1.75 in.	5
1570-*	6 in.	9 in. x 5 in.	1

To order: replace the asterisk (*) with the desired character listed above.

15 Series Combo Packs

- Standard package: 25 assorted cards

Catalog #	Character Height	Marker Size	Markers Per Card
Letter Combo Packs			
1500-LTR KIT	0.25 in.	0.375 in. x 0.25 in.	144
1520-LTR KIT	0.625 in.	0.75 in. x 0.562 in.	32
1530-LTR KIT	1 in.	1.5 in. x 0.875 in.	10
1534-LTR KIT	2 in.	2.25 in. x 0.875 in.	10
1550-LTR KIT	3 in.	3.5 in. x 1.5 in.	6
1560-LTR KIT	3.875 in.	5 in. x 1.75 in.	5
1570-LTR KIT	6 in.	9 in. x 5 in.	1
Number Combo Packs			
1500-# KIT	0.25 in.	0.375 in. x 0.25 in.	144
1520-# KIT	0.625 in.	0.75 in. x 0.562 in.	32
1530-# KIT	1 in.	1.5 in. x 0.875 in.	10
1534-# KIT	2 in.	2.25 in. x 0.875 in.	10
1550-# KIT	3 in.	3.5 in. x 1.5 in.	6
1560-# KIT	3.875 in.	5 in. x 1.75 in.	5
1570-# KIT	6 in.	9 in. x 5 in.	1





34 Series Indoor Numbers and Letters

- B-498 plastic coated cloth numbers and letters with pressure sensitive adhesive
- The adhesive and cloth backing offers excellent holding power, yet allows for clean removal and repositioning if necessary



34 Series Individual Cards

- A single number, letter or character
- Sold as individual cards

Catalog #	Character Height	Marker Size	Markers Per Card
Available in numbers (0-9), letters (A-Z), dashes (DSH)			
3400-*	0.25 in.	0.375 in. x 0.25 in.	144
3410-*	0.375 in.	0.5 in. x 1.031 in.	78
Available in numbers (0-9), letters (A-Z), dashes (DSH) and arrows (ARO).			
3420-*	0.625 in.	0.75 in. x 0.562 in.	32
3430-*	1 in.	1.5 in. x 0.875 in.	10
3440-*	1.937 in.	2.25 in. x 0.875 in.	10
3450-*	2.937 in.	3.5 in. x 1.5 in.	6
Available in numbers (0-9), letters (A-Z), dashes (DSH) and blanks (BLANK).			
3460-*	3.875 in.	5 in. x 1.75 in.	5
3470-*	6 in.	9 in. x 5 in.	1

To order: replace the asterisk (*) with the desired characters listed above.



34 Series Combo Packs

- Combo of all numbers or all letters
- Standard package: 25 assorted cards

Catalog #	Character Height	Marker Size	Markers Per Card
Letter Combo Packs (A-Z)			
3400-LTR KIT	0.25 in.	0.375 in. x 0.25 in.	144
3410-LTR KIT	0.375 in.	0.5 in. x 1.031 in.	78
3420-LTR KIT	0.625 in.	0.75 in. x 0.562 in.	32
3430-LTR KIT	1 in.	1.5 in. x 0.875 in.	10
3440-LTR KIT	1.937 in.	2.25 in. x 0.875 in.	10
3450-LTR KIT	2.937 in.	3.5 in. x 1.5 in.	6
3460-LTR KIT	3.875 in.	5 in. x 1.75 in.	5
3470-LTR KIT	6 in.	9 in. x 5 in.	1
Number Combo Packs (0-9)			
3400-# KIT	0.25 in.	0.375 in. x 0.25 in.	144
3410-# KIT	0.375 in.	0.5 in. x 1.031 in.	78
3420-# KIT	0.625 in.	0.75 in. x 0.562 in.	32
3430-# KIT	1 in.	1.5 in. x 0.875 in.	10
3440-# KIT	1.937 in.	2.25 in. x 0.875 in.	10
3450-# KIT	2.937 in.	3.5 in. x 1.5 in.	6
3460-# KIT	3.875 in.	5 in. x 1.75 in.	5
3470-# KIT	6 in.	9 in. x 5 in.	1



34 Series Consecutive Markers

- Contains sequence on one card (larger sized cards split the alphabet)
- Sold as individual cards

Catalog #	Legend	Char. Height	Marker Size	Markers Per Card
34010	(0-9)	0.25 in.	0.375 x 0.25 in.	144
34110	(0-9)	0.375 in.	0.5 x 1.031 in.	78
34138	(A-Z)	0.375 in.	0.5 x 1.031 in.	78
34210	(0-9)	0.625 in.	0.75 x 0.562 in.	32
34238	(A-Z)	0.625 in.	0.75 x 0.562 in.	32
34310	(0-9)	1 in.	1.5 x 0.875 in.	10
34340	(A-J)	1 in.	1.5 x 0.875 in.	10
34341	(K-T)	1 in.	1.5 x 0.875 in.	10
34342	(U-Z)	1 in.	1.5 x 0.875 in.	10
34410	(0-9)	1.937 in.	2.25 x 0.875 in.	10
34440	(A-J)	1.937 in.	2.25 x 0.875 in.	10
34441	(K-T)	1.937 in.	2.25 x 0.875 in.	10
34442	(U-Z)	1.937 in.	2.25 x 0.875 in.	10



97 Series Indoor / Outdoor Numbers and Letters

- B-946 markers with superior abrasion, chemical and UV resistance
- Designed for permanent applications in indoor and outdoor environments



97 Series Individual Cards

- Sold as individual cards

Catalog #	Card Size	Character Height	Markers Per Card
9712-*	0.75 in. x 2 in.	0.625 in.	20
9713-*	1.5 in. x 1 in.	1 in.	10
9714-*	2.25 in. x 1.8 in.	1.937 in.	5

To order: replace the asterisk (*) with the desired number (0-9), capital letter (A-Z) or dash (DSH).



97 Series Combo Packs

- Standard package: 25 assorted cards

Catalog #	Char. Height	Marker Size	Markers Per Card
Letter Combo Packs			
9712-LTR KIT	0.625 in.	0.75 in. x 2.031 in.	20
9713-LTR KIT	1 in.	1.5 in. x 1.187 in.	10
9714-LTR KIT	2 in.	2.25 in. x 1.187 in.	5
Number Combo Packs			
9712-# KIT	0.625 in.	0.75 in. x 2.031 in.	20
9713-# KIT	1 in.	1.5 in. x 1.187 in.	10
9714-# KIT	2 in.	2.25 in. x 1.187 in.	5



Numbers and Letters

BradyID.com/s36



Helvetica Quik-Align® Kits and 10-Packs

- B-933 vinyl with permanent adhesive
- Self-spacing and self-aligning die-cuts

Helvetica Quik-Align Kits:

10 identical characters or arrows; 5 identical \$ or &; Punctuation includes 5 periods and 5 commas

Size	Black Lowercase	White Lowercase	Black Uppercase
1 in. kit	-	-	-
2 in. kit	80012	80032	-
3 in. kit	80013	80033	-
4 in. kit	80014	80034	-
6 in. kit	80016	80036	-

10-Pack Refills:

10 identical characters or arrows; 5 identical \$ or &; Punctuation includes 5 periods and 5 commas

Size	Black Lowercase	White Lowercase	Black Uppercase
1 in.	8235-*	8305-*	8200-* Available in (0-9), (&), (\$) only
1.5 in.	8240-*	-	8205-* Available in (0-9), (&), (\$) only
2 in.	8245-*	-	-
3 in.	8250-*	8320-*	8215-*
4 in.	8255-*	8325-*	8220-* Available in (0-9), (&), (\$) only
6 in.	8265-*	8335-*	-

Letter sizes refer to uppercase letters, lowercase are proportional. To order: replace the asterisk (*) with the desired number (0-9), capital letter (A-Z), (&), (\$) or punctuation (PUN).*



Gothic Quik-Align® Kits and 10-Packs

- B-933 vinyl with permanent adhesive
- Self-spacing and self-aligning die-cuts

Gothic Quik-Align Kits:

Includes 20 each of A, E, I, L, N, O, R, S, T, and 0-9; 10 each of remaining letters; 5 each of \$ and & punctuation

Size	Black	Black Condensed	White	Yellow	Red
1 in. kit	52203	52180	52204	-	-
2 in. kit	52207	52184	52208	52210	-
3 in. kit	52211	52188	52212	52214	-
4 in. kit	52215	-	52216	-	52213
6 in. kit	52219	-	52220	-	52217

10-Pack Refills:

Includes 10 identical characters or arrows; 5 identical \$ or &; Punctuation includes 5 periods and 5 commas

Size	Black	Black Condensed*	White	Yellow	Red
1 in.	5010-*	-	5040-*	-	-
2 in.	5050-*	6450-*	5080-*	5060-*	-
3 in.	5100-*	6500-*	5130-*	5110-*	5120-*
4 in.	5140-*	-	5170-*	5150-*	5160-*
6 in.	5180-*	-	5210-*	-	-

To order: replace the asterisk (*) with the desired number (0-9), capital letter (A-Z), arrow (ARO), (\$), (&) or punctuation (PUN). * Arrows not available in Condensed Black

Number and Letter Labels



3-Series Glow-in-the-Dark Ultra Reflective Numbers and Letters

- 7 times more reflective than other reflective materials
- Black characters w/ glow-in-the-dark border on a highly-reflective silver background
- Designed for permanent application in indoor or outdoor environments

Catalog #	Marker Size	Character Size	Qty
3000-*	2.875 in. x 1.5 in.	2 in.	10
3010-*	3.5 in. x 2.5 in.	3 in.	10
3020-*	6 in. x 3 in.	5 in.	10

To order: replace the asterisk (*) with the desired number (0-9), capital letter (A-Z), dash (DSH), blank (BLANK), ampersand (&) or period (PRD).



BradyGlo™ Gothic Quik-Align Numbers and Letters

- Photoluminescent material charges in 5 minutes at 1000 Lux for 10+ hours of glow time
- Consistent glow life and unlimited rechargability
- Complies with ASTM 2030-99

Catalog #	Character Size	Qty
6001-*	1 in.	25
6002-*	2 in.	25
6003-*	3 in.	25
6004-*	4 in.	25

To order: replace the asterisk (*) with the desired number (0-9) or capital letter (A-Z).



Die-cut Magnetic Numbers

- Magnetic numbers are perfect for safety scoreboards

Catalog #	Size	Qty.
57624	1.5 in.	15 each of 0-3; 8 each of 4-9



Aluminum Utility Panels

- 20 mil. aluminum panels are designed to be rugged, yet conform to pole
- Recommended use with B-946 vinyl or B-997 reflective markers
- 7.25 in. panel holds eight markers
- 12 in. panel holds eleven reflective markers or twelve vinyl markers

Catalog #	Panel Size	Qty.
97198	1.75 in. x 7.25 in.	25
97199	1.75 in. x 12 in.	25



Outdoor Numbers and Letters (B-946)

- B-946 tough vinyl film provides high visibility and lasting performance
- UV resistant protects against fading and shrugs off oil and water
- Meets APWA color code: black on orange for communications yellow on black for electric, oil and gas
- Standard package: 1 card

Catalog #	Char. Height	Marker Size	Color	Markers Per Card
6560-*	1 in.	1.5 x 0.875 in.	Blk / Org	10
6570-*	2 in.	2.25 x 0.875 in.	Blk / Org	10
7890-*	1 in.	1.5 x 0.875 in.	Ylw / Blk	10
7897-*	2 in.	2.25 x 0.875 in.	Ylw / Blk	10

To order: replace the asterisk (*) with the desired number (0-9), capital letter (A-Z) or dash (DSH).



BradyLite® Reflective Numbers and Letters (B-997)

- Reflects light 100 times brighter than a plain white surface
- Will perform in tough environmental conditions
- Can be applied in temps as low as 10° F
- Standard package: 25 cards

Catalog #	Char. Height	Marker Size	Color	Markers Per Card
5900-*	1 in.	1.5 x 1 in.	Blk / Slvr	1
5905-*	1 in.	1.5 x 1 in.	Ylw / Blk	1
5920-*	1 in.	1.5 x 1 in.	Blk / Ylw	1
5890-*	1.5 in.	1.875 x 1.375 in.	Ylw / Blk	1
5000-*	2.5 in.	2.875 x 1.75 in.	Ylw / Blk	1
Only available in numbers (0-9) and blank (BLANK)				
5910-*	1 in.	1.5 x 1 in.	Blk / Org	1

To order: replace the asterisk (*) with the desired number (0-9), capital letter (A-Z), dash (DSH) or blank (BLANK)



Pre-printed KVA Markers

- Help determine the KVA classification of pole-mounted transformers
- Yellow numbers printed on B-997 BradyLite Reflective Sheeting
- Come with slit liner for easy application
- Standard Package: 25 cards

Catalog #	Legend	Marker Size	Markers Per Card
50010	7 ½	2.875 in. x 3.25 in.	1
50011	10	2.875 in. x 3.25 in.	1
50012	15	2.875 in. x 3.25 in.	1
50013	25	2.875 in. x 3.25 in.	1
50015	50	2.875 in. x 3.25 in.	1
50016	75	2.875 in. x 3.25 in.	1
50014	37 ½	2.875 in. x 3.25 in.	1
50017	100	2.875 in. x 3.25 in.	1
50018	150	2.875 in. x 3.25 in.	1
50019	167	2.875 in. x 3.25 in.	1
50020	500	2.875 in. x 3.25 in.	1



Seriesystem™ Kit Serialized Markers

- B-498 repositionable vinyl cloth with black character on yellow background
- 10 single digit cards (0-9) included in each kit for replacing numbers
- Standard Package:
 - Legend 01-99 is 6/card, 27 cards/package
 - Legend 001-999 is 12/card, 94 cards/package

Catalog #	Legends	Char. Height	Marker Size	Markers Per Card
34353	01-99	1 in.	1.5 x 1.5 in.	6
34253	001-999	0.625 in.	0.75 x 1.5 in.	12



Aluminum Embossed Numbers and Letters

- Roman style numbers and letters contain pre-punched holes for easy installation; 1 in. nails included
- Standard Package: 10

Catalog #	Character Height	Qty.
1600-*	3 in.	10

To order: replace the asterisk (*) with the desired number (0-9), capital letter (A-Z).

Safety Signs

BradyID.com/s36

Safety and Facility Signs

Safety signs are a necessary and required component for warning and communicating messages or notices to your employees, customers and the general public.

In order to provide a clear and concise message, the sign must meet a variety of requirements and standards. Selecting and placing a safety sign in your facility is more than a workplace requirement, but an opportunity to prevent costly accidents or dangerous hazards within your facility.



Top 5 things to consider when choosing safety signs

- 1. Comply with applicable regulations**
Several regulating bodies come into play when posting signs throughout your facility. Familiarize yourself with these regulations to increase safety and avoid costly fines.
- 2. Display a clear and visible message**
The header you select is directly tied to the severity of the hazard. Make sure you are communicating the correct message with the right sign headers.
- 3. Use visually intuitive pictograms**
75% of knowledge is gained through visuals. Use pictogram visuals to convey your message quickly and more accurately in multi-language environments.
- 4. Location, location, location**
Location is extremely important when it comes to sign placement. Make sure your signs are posted at eye level and in highly visible locations.
- 5. Use the right material for your application**
Brady offers a wide variety of sign materials for unique applications throughout your facility. But make sure you are choosing the right material to avoid having to replace the sign more frequently than needed.

1. Comply with applicable regulations

Check the specific sign requirements of the regulation you're complying with. Exit and fire extinguisher signs are covered by NFPA and IBC, general and chemical hazards by OSHA, traffic and parking signs by the Dept. of Transportation. Layout, text and signal words are covered by OSHA and ANSI. Below are several of the common regulations affecting signs:

Organization	Regulations
OSHA – Occupational Safety and Health Administration	OSHA 1910.37 Means of Egress, General (Exit Signs and Routes) OSHA 1910.144 Safety Color Code for Marking Physical Hazards OSHA 1910.145 Specifications for Accident Prevention Signs and Tags OSHA 1910.146 Permit-Required Confined Spaces OSHA 1910.147 Control of Hazardous Energy (Lockout/Tagout) OSHA 1910.1200 Hazard Communication (includes updated GHS standard) OSHA 1910.303 Electrical Subpart S: ((g)(2)(iii) and (h)(5)(iii)[B] – Warning Signs) OSHA 1926.200 Signs, Signals and Barricades for Construction
DOT – Department of Transportation	Hazardous Materials Warning Placards and Labels - Title 49, Code of Federal Regulations, Part 172 Subpart D–Marking, Subpart E – Labeling, Subpart F-Placarding - Title 49, Code of Federal Regulations, Parts 100-199
NFPA – National Fire Protection Association	NFPA 70: National Electrical Code NFPA 101: Life Safety Code NFPA 101B: Code for Means of Egress for Buildings and Structures NFPA 704: Standard System for the Identification of the Hazards of Materials for Emergency Response
ICC – International Code Council	IBC 2015 International Building Code IFC 2015 International Fire Code
IMO – International Maritime Organization	Resolution A.752(18) Egress and Low Level Lighting
ANSI – American National Standards Institute	ANSI Z535.1-2006 (R2011), Safety Color Code ANSI Z535.2-2011, Environmental and Facility Safety Signs ANSI Z535.3-2011, Criteria for Safety Symbols ANSI Z535.4-2011, Product Safety Signs and Labels
ISO – International Standards Organization	ISO 7010:2011 Prescribes Safety Signs for the Purposes of Accident Prevention, Fire Protection, Health Hazard Information and Emergency Evacuation. ISO 7001:2007 Graphical Symbols, Public Information Symbols
ADA – Americans with Disabilities Act	2010 ADA Standards for Accessible Design; 703 Signs Meet Occupational Health Administration (OSHA 1910.145) and ANSI (ANSI Z535) regulations and guidelines.

ANSI sign standard increases comprehension and safety

Under OSHA's Hazard Communication Standard update, organizations can now use either the American National Standard Institute (ANSI) standards from 1967-1968 (ANSI Z53.1, Z35.1 and Z35.2) or from 2011 (ANSI Z535.1, Z535.2 and Z535.5) for safety signage.



Previous standard

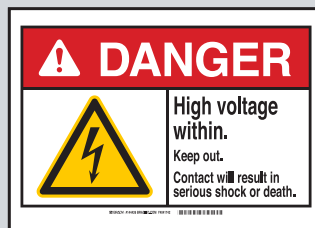

New standard

Redesign includes:

1. A safety alert symbol in the header
2. Three part text statement with:
 - the hazard
 - the possible consequences
 - how to avoid the hazard
3. More visual pictograms

Safety Signs

BradyID.com/s36

2. Display a clear and visible message

Sign headers may seem interchangeable, but actually deliver very different messages. ANSI and OSHA specify that safety signs must indicate and define specific hazards that, without identification, may lead to accidental injury to workers, customers or the general public.

Safety Signs	Increasing Severity	DANGER imminent hazard may result in death or serious injury	<ul style="list-style-type: none">• Mark hazardous situations with a high probability of death or serious injury.• The word "Danger" should be limited to most extreme situations.• Not used for property damage hazards unless personal injury risk to this level is also involved.
		WARNING Potential hazard may result in death or serious injury	<ul style="list-style-type: none">• Indicates potential hazards which, if not avoided, could result in death or serious injury.• Appropriate for placement outside of the area or on the exterior of enclosures containing a Danger-level hazard.• Not used for property damage hazards unless personal injury risk to this level is also involved.
		CAUTION Potential hazard may result in minor or moderate injury	<ul style="list-style-type: none">• Indicates potential hazards which, if not avoided, may result in minor or moderate injury.• May be used to alert against unsafe practices that may cause property damage.
		NOTICE Statement related to safety of personnel or protection of property	<ul style="list-style-type: none">• Indicates a statement of company policy directly or indirectly related to the safety of personnel or protection of property.• Should not be associated with a hazard or hazardous situation and shall not be used in place of DANGER, WARNING or CAUTION.
		SAFETY Statement related to safe practices or safety equipment	<ul style="list-style-type: none">• Indicate general instructions relative to safe work practices or indicate the location of safety equipment (e.g. eyewash station)

Safety Signs

3. Use visually intuitive pictograms for increased comprehension

As immigration rates increase and demographics evolve, it is essential to communicate messages across many different cultural backgrounds. Everyone within the facility should be able to understand the message being communicated.

Pictograms provide a universal way to communicate warnings to all employees and visitors, regardless of language or demographic, and can provide a better understanding of hazards. Pictograms provide an easy to understand alternative to multi-lingual signs, which can often be difficult to read.

Examples of standard ISO pictograms are below:

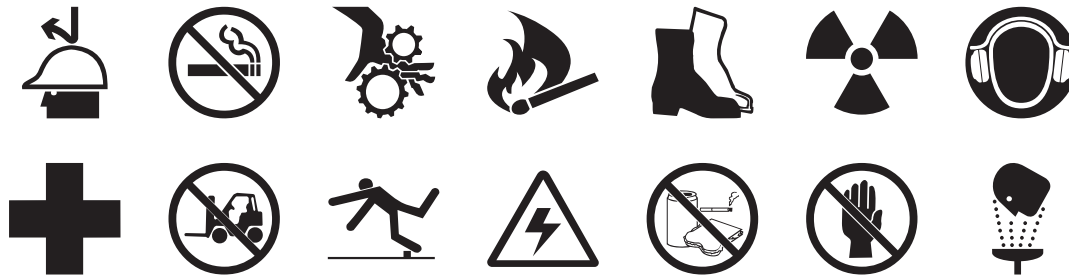

Safety sign letter height (ANSI Z535.2-2011)

The size and letter height used on your sign makes a difference in the readability and clarity of your message.

9.2.2 Overall size of the lettering

The overall size of the lettering shall be determined by the distance from which the sign can be safely and easily read. The message should be concise and practical. Letters shall be adequately spaced and not crowded.

9.2.3 Minimum letter height

Minimum letter height shall be one unit in height for every 150 units of safe viewing distance from the hazard alerting device for signal words and one unit in height for every 300 units viewing distance for the majority of other words contained on the word message panel. The safe viewing distance must be determined for each specific case where a safety sign is needed. The message panel text shall meet the legibility criteria at the determined safe viewing distance.

Viewing Distance	< 4 ft.	5 ft.	8 ft.	10 ft.	15 ft.	20 ft.	30 ft.	40 ft.	60 ft.	80 ft.	100 ft.	125 ft.	150 ft.	200 ft.
In favorable reading conditions minimum letter height is:	0.16 in. *	0.24 in.	0.32 in.	0.40 in.	0.60 in.	0.80 in.	1.20 in.	1.60 in.	2.40 in.	3.20 in.	4.00 in.	5.00 in.	6.00 in.	8.00 in.
In unfavorable reading conditions recommended letter height is:	0.33 in.	0.50 in.	0.66 in.	0.83 in.	1.27 in.	1.68 in.	2.51 in.	3.36 in.	5.04 in.	6.72 in.	8.40 in.	10.49 in.	12.58 in.	16.79 in.

*0.16 inch (4.1 mm) is the suggested minimum type size for use on environmental / facility safety signs.

Safety Signs

BradyID.com/s36

4. Sign locations

It is important that your sign will communicate the safety message to all of your employees, customers and the general public. The sign should be clear, concise and placed in a highly visible location. Placement of the sign is a key aspect in transmitting your message.

Keep the following in mind when choosing sign locations.

- ✓ Signs must be clear, visible and unobstructed.
- ✓ Signs must be placed to alert and inform employees of hazards. They should have sufficient time to avoid the hazard and take appropriate action.
- ✓ Lighting, maintenance and storage should be considered during the placement process to make sure the sign can be clearly illuminated.
- ✓ Inspect, maintain and keep signs clean to ensure they are in good condition.
- ✗ Signs should not be placed in moveable areas or near areas that could obstruct sign visibility.
- ✗ If the message is no longer relevant or the hazard ceases to exist, the sign should be removed as soon as possible.



Brady signs help keep your employees and visitors safe – both inside and outside your facility.

Examples of indoor locations

- Areas with restricted access
- Areas with PPE requirements
- Established emergency egress routes
- Locations with hazardous materials, electrical and confined spaces
- Around machine and equipment
- Areas prone to slips, trips and falls
- Areas with fire, emergency and first aid equipment



Examples of outdoor applications

- Control the flow of vehicle traffic
- Indicate visitor, employee and handicap parking
- Outside shipping and receiving areas
- Around storage and equipment area
- Post security policies including no smoking or prohibited weapons
- Areas of restricted access or admission including employee and visitor entrances



Safety Signs

BradyID.com/s36

5. The right material for your application

Choosing a sign material may not seem significant, but it's important to remember that different materials are equipped for different environments and applications. If you don't select the proper material, you could end up having to replace the sign more frequently than needed.

Sign Material Comparison

Material Type	Description	Protected Graphics	For Outdoor Use	Average Outdoor Durability	Chemical Resistance	Abrasion Resistance	Max. Temp	Thickness (inch)
Flexible Sign Materials								
Adhesive	B-302 High performance polyester	✓	✓	8 years	Excellent	Excellent	230° F (100° C)	.006-.010
Adhesive	B-324 BradyGlo™ photoluminescent polyester	-	-	-	Good	Good	176° F (80° C)	.008
Adhesive	B-485 Polyester film	✓	-	-	Good	Good	122° F (50° C)	.011
Adhesive	B-523 Photoluminescent polyester film	-	-	-	Good	Good	176° F (80° C)	.0096
Adhesive	B-534 Polyester floor sign with anti-skid tread	✓	-	-	Good	Good	130° F (54° C)	.011
Adhesive	B-808 BradyGlo anti-slip polyester floor sign	✓	-	-	Good	Good	158° F (70° C)	.017
Adhesive	B-819 Anti-slip vinyl floor sign	✓	-	-	Good	Good	158° F (70° C)	.012
Adhesive	B-928 Write-on vinyl with cold temp adhesive	-	✓	2 years	Good	Good	176° F (80° C)	.005
Adhesive	B-946 Self-sticking vinyl	-	✓	10 years	Fair	Good	180° F (82° C)	.004
Adhesive	B-984 Photoluminescent polyester film	-	-	-	Good	Good	176° F (80° C)	.013
Adhesive	B-997 BradyLite® reflective vinyl	-	✓	4-6 years	Good	Good	200° F (93° C)	.007
Non-Adhesive	B-101 Polycoated tagstock	-	-	-	Good	Good	158° F (70° C)	.010
Non-Adhesive	B-586 Eco-friendly paperboard	-	-	-	Good	Good	175° F (80° C)	.060
Non-Adhesive	B-811 Magnetic vinyl	-	✓	2-4 years	Good	Good	158° F (70° C)	.025
Rigid Sign Materials								
Metal	B-555 Aluminum	✓	✓	8 years	Excellent	Excellent	230° F (110° C)	.040-.090
Metal	B-959 Reflective aluminum	-	✓	4-8 years	Good	Good	175° F (80° C)	.040-.080
Metal	B-986 Photoluminescent polyester film on aluminum	-	-	-	Good	Good	175° F (80° C)	.049
Metal	B-995 Diamond-grade™ reflective aluminum	-	✓	7 years	Good	Good	212° F (100° C)	.097
Fiberglass	B-120 Premium fiberglass	✓	✓	25 years	Excellent	Excellent	193° F (90° C)	.100
Fiberglass	B-140 Polyester on fiberglass	✓	✓	8 years	Excellent	Excellent	175° F (79° C)	.070
Fiberglass	B-320 Sub surface printed lexan on fiberglass	✓	✓	8 years	Good	Good	175° F (79° C)	.070
Fiberglass	B-382 Sub surface printed polycarbonate on fiberglass	✓	✓	8 years	Good	Good	175° F (79° C)	.090
Plastic	B-1 Thermoset plastic	-	✓	8 years	Good	Good	193° F (89° C)	.062
Plastic	B-347 BradyGlo™ phosphorescent polyester on polystyrene	-	-	-	Good	Good	175° F (79° C)	.068
Plastic	B-355 BradyGlo steel encased photoluminescent plastic	-	-	-	Good	Good	122° F (50° C)	.250
Plastic	B-401 Polystyrene plastic	✓	✓	5 years	Good	Good	175° F (79° C)	.060
Plastic	B-450 Polyethylene plastic	-	-	-	Good	Good	180° F (82° C)	.055
Plastic	B-493 Plastic v-shaped signs	-	✓	2 years	Good	Good	193° F (90° C)	.100
Plastic	B-563 Eco-friendly plastic (70% post consumer waste)	-	✓	5 years	Good	Good	185° F (85° C)	.055
Plastic	B-793 Polystyrene	-	✓	1-3 years	Poor	Good	165° F (74° C)	-
Plastic	B-836 Temporary sign fluted polypropylene	-	✓	1 year	Good	Good	130° F (54° C)	.156
Plastic	B-866 ToughWash® Polypropylene	✓	-	-	Excellent	Good	175° F (80° C)	.035
Plastic	B-869 ToughWash Metal-Detectable Polypropylene	✓	-	-	Good	Good	175° F (80° C)	.098
Plastic	B-985 Photoluminescent polyester film on polystyrene	-	-	-	Good	Good	175° F (80° C)	.069

Most popular sign materials

Rigid



B-120 Premium fiberglass

B-120 Premium fiberglass (FB)

- Most durable material – will not chip, fade, rust, shatter or peel
- Graphics protected under fiberglass layer
- Excellent chemical and abrasion resistance and ideal for outdoor and harsh environments
- Up to 25 year outdoor life



B-555 Aluminum

B-555 Aluminum (AL)

- Durable for outdoor usage – withstands wind, rain, sunlight and high temperatures
- Uses UV inks and UV clear coat protection for fade resistance
- Used for parking, building and informational signs
- 5-8 year outdoor life



B-401 Plastic

B-401 Plastic (PL)

- Cost-effective durable polystyrene
- Ideal for directional, informational, department and safety applications
- Conforms to well-curved surfaces
- Up to 5 year outdoor life

Flexible



B-302 Self-sticking polyester

B-302 Self-sticking polyester (SS)

- Withstands wide temperature variations (up to 230° F)
- Protected graphics holds up to repeated spills and cleanings
- Permanent adhesive ideal for machine / equipment signs and labeling
- Up to 8 year outdoor life



B-946 Self-sticking vinyl

B-946 Self-sticking durable vinyl (SSV)

- High gloss vinyl printed with UV resistant inks
- Permanent cold temp acrylic adhesive
- Good for outdoor applications on curved surfaces
- Fair chemical and abrasion resistance
- Durable, provides up to 10 years outdoor life

Design Online Custom Safety Signs



With Brady's online design tool, creating custom safety signs is simple, affordable and fast.

- Custom message
- Variety of materials
- No minimum order
- Sizes range from 3.5 in. to 36 in.
- Ships quickly

Design your signs at
BradyID.com



Signs Table of Contents

Use the following to view signs group by legend topics.

Each section is arranged alphabetically by header, then by legend.

Can't find your sign?
View the Sign Legend Index
(Page 588)

Example:



124745	7" x 10"	SS
124748	10" x 14"	SS
124744	7" x 10"	PL
124747	10" x 14"	PL
124743	7" x 10"	AL
124746	10" x 14"	AL

Catalog # Size Material



Safety and Facility

Admittance	412
ANSI Z535.....	420
Bilingual / Spanish	434
Biohazard	445
Blank Signs	446
Braille Signs	447
Chemical: Hazardous Material.....	448
Chemical: Proposition 65.....	461
Chemical: Vehicle Placards.....	463
Confined Space	466
Construction Site.....	469
Door	470
Electrical Hazard.....	472
Exit / Directional	475
Exit / Directional: Severe Weather ...	479
Evacuation / Assembly Point.....	484
Evacuation IMO.....	485
Fire Safety	486
First Aid	493
Floor.....	496
Funny	498
High Visibility	499
Hospital	502
Lockout Tagout	504
Machine and Operational.....	506
Maintenance.....	518
No Cellular Phones.....	521
No Firearms / Concealed Carry	521
No Smoking / Smoking Areas.....	522
Personal Hygiene.....	528
Personal Protection (PPE)	529
Radiation and Laser	541
Recycle and Environment	544
Restroom	545
Safety Sign Sliders	546
Safety Banners	548
Safety Posters.....	551
Safety Slogans.....	553
Scoreboards.....	554
Security	555
Temporary	558
ToughWash® Signs	559

Traffic

Parking.....	560
Parking: E-Vehicle.....	565
Parking: Handicapped.....	566
Rail Road Traffic	568
Road Construction	569
Shipping / Receiving Traffic	570
Traffic Control	573

Misc.

Sign Accessories.....	578
Custom Signs	583
Sign Legend Index.....	588

Admittance Signs

BradyID.com/s36

Admittance Signs

Brady admittance signs indicate and identify areas of access and are required in virtually every workplace. They alert employees to potential hazards, safety warning and cautionary notices. They also restrict access to property and are available in a variety of sizes and materials.





























Sign Selection Guide

- FB** - Premium fiberglass (B-120)
- SS** - Self-sticking polyester (B-302)
- PL** - Plastic (B-401)
- AL** - Aluminum (B-555)
- BGSS** - BradyGlo™ self-stick polyester (B-324)
- BGPL** - BradyGlo™ plastic (B-347)

Material Comparison page 408
Sign Legend Index..... page 588

					
124649 7" x 10" SS 124652 10" x 14" SS 124648 7" x 10" PL 124651 10" x 14" PL 124647 7" x 10" AL 124650 10" x 14" AL	124655 7" x 10" SS 124658 10" x 14" SS 124654 7" x 10" PL 124657 10" x 14" PL 124653 7" x 10" AL 124656 10" x 14" AL	95329 7" x 10" FB 95333 10" x 14" FB 95326 7" x 10" SS 95330 10" x 14" SS 95327 7" x 10" PL 95332 10" x 14" PL 95328 7" x 10" AL 95331 10" x 14" AL	84002 7" x 10" SS 84003 10" x 14" SS 22053 7" x 10" PL 22054 10" x 14" PL 40617 7" x 10" AL 40618 10" x 14" AL	84006 7" x 10" SS 84007 10" x 14" SS 40621 7" x 10" AL 40622 10" x 14" AL	95341 10" x 14" FB 95338 10" x 14" SS 95335 7" x 10" PL 95340 10" x 14" PL 95339 10" x 14" AL
					
75444 7" x 10" FB 47093 10" x 14" FB 84008 7" x 10" SS 84009 10" x 14" SS 22059 7" x 10" PL 22060 10" x 14" PL 40623 7" x 10" AL 40624 10" x 14" AL	124667 7" x 10" SS 124670 10" x 14" SS 124666 7" x 10" PL 124669 10" x 14" PL 124665 7" x 10" AL 124668 10" x 14" AL	69102 10" x 14" FB 84010 7" x 10" SS 84011 10" x 14" SS 22061 7" x 10" PL 22062 10" x 14" PL 40625 7" x 10" AL 40626 10" x 14" AL	69103 10" x 14" FB 84012 7" x 10" SS 84013 10" x 14" SS 22063 7" x 10" PL 22064 10" x 14" PL 40627 7" x 10" AL 40628 10" x 14" AL	69106 10" x 14" FB 84014 7" x 10" SS 84015 10" x 14" SS 22065 7" x 10" PL 22066 10" x 14" PL 40629 7" x 10" AL 40630 10" x 14" AL	124661 7" x 10" SS 124664 10" x 14" SS 124660 7" x 10" PL 124663 10" x 14" PL 124659 7" x 10" AL 124662 10" x 14" AL
					
124673 7" x 10" SS 124676 10" x 14" SS 124672 7" x 10" PL 124675 10" x 14" PL 124671 7" x 10" AL 124674 10" x 14" AL	124679 7" x 10" SS 124682 10" x 14" SS 124678 7" x 10" PL 124681 10" x 14" PL 124677 7" x 10" AL 124680 10" x 14" AL	84018 7" x 10" SS 84019 10" x 14" SS 22067 7" x 10" PL 40631 7" x 10" AL 40632 10" x 14" AL	124685 7" x 10" SS 124688 10" x 14" SS 124684 7" x 10" PL 124687 10" x 14" PL 124683 7" x 10" AL 124686 10" x 14" AL	124697 7" x 10" SS 124700 10" x 14" SS 124696 7" x 10" PL 124699 10" x 14" PL 124695 7" x 10" AL 124698 10" x 14" AL	124691 7" x 10" SS 124694 10" x 14" SS 124690 7" x 10" PL 124693 10" x 14" PL 124689 7" x 10" AL 124692 10" x 14" AL
					
124703 7" x 10" SS 124706 10" x 14" SS 124702 7" x 10" PL 124705 10" x 14" PL 124701 7" x 10" AL 124704 10" x 14" AL	95345 7" x 10" FB 95349 10" x 14" FB 95346 10" x 14" SS 95343 7" x 10" PL 95348 10" x 14" PL 95344 7" x 10" AL 95347 10" x 14" AL	73472 14" x 20" FB 84026 7" x 10" SS 84027 10" x 14" SS 22069 7" x 10" PL 22070 10" x 14" PL 40633 7" x 10" AL	124709 7" x 10" SS 124712 10" x 14" SS 124708 7" x 10" PL 124711 10" x 14" PL 124707 7" x 10" AL 124710 10" x 14" AL	124715 7" x 10" SS 124718 10" x 14" SS 124714 7" x 10" PL 124717 10" x 14" PL 124713 7" x 10" AL 124716 10" x 14" AL	124721 7" x 10" SS 124724 10" x 14" SS 124720 7" x 10" PL 124723 10" x 14" PL 124719 7" x 10" AL 124722 10" x 14" AL

Admittance Signs (continued)

 <p>CAUTION UNAUTHORIZED PERSONNEL KEEP OUT</p>	 <p>CAUTION USE OTHER DOOR</p>	 <p>DANGER ADMITTANCE LIMITED TO AUTHORIZED PERSONNEL</p>	 <p>DANGER ADMITTANCE ONLY TO PERSONNEL WORKING IN THIS AREA</p>	 <p>DANGER AUTHORIZED PERSONNEL ONLY</p>	 <p>DANGER AUTHORIZED PERSONNEL ONLY</p>
124727 7" x 10" SS 124730 10" x 14" SS 124726 7" x 10" PL 124729 10" x 14" PL 124725 7" x 10" AL 124728 10" x 14" AL	124733 7" x 10" SS 124736 10" x 14" SS 124732 7" x 10" PL 124735 10" x 14" PL 124731 7" x 10" AL 124734 10" x 14" AL	70820 14" x 20" FB 84032 7" x 10" SS 84033 10" x 14" SS 22071 7" x 10" PL 22072 10" x 14" PL 40635 7" x 10" AL 40636 10" x 14" AL	84034 7" x 10" SS 84035 10" x 14" SS 22074 10" x 14" PL 40637 7" x 10" AL 40638 10" x 14" AL	95369 7" x 10" FB 95373 10" x 14" FB 95366 7" x 10" SS 95370 10" x 14" SS 95367 7" x 10" PL 95372 10" x 14" PL SP430D 14" x 10" PL 95368 7" x 10" AL 95371 10" x 14" AL	118156 7" x 10" EcoSS 118157 10" x 14" EcoSS 116100 7" x 10" EcoPL 116101 10" x 14" EcoPL 115936 7" x 10" EcoPaper
 <p>DANGER AUTHORIZED PERSONNEL ONLY</p>	 <p>DANGER AUTHORIZED PERSONNEL ONLY</p>	 <p>DANGER AUTHORIZED PERSONNEL ONLY BEYOND THIS POINT</p>	 <p>DANGER AUTHORIZED PERSONNEL ONLY</p>	 <p>DANGER AUTHORIZED PERSONNEL ONLY CHECK WITH CONTROL ROOM BEFORE ENTERING</p>	 <p>DANGER BARRICADE AREA DO NOT ENTER WITHOUT AUTHORIZATION OR SUPERVISION</p>
41502 7" x 10" PL	131637 7" x 10" FB 131638 10" x 14" FB 131635 7" x 10" SS 131636 10" x 14" SS 131633 7" x 10" PL 131634 10" x 14" PL 131631 7" x 10" AL 131632 10" x 14" AL	10825 10" x 14" B-140	95396 7" x 10" FB 95400 10" x 14" FB 95393 7" x 10" SS 95397 10" x 14" SS 95394 7" x 10" PL 95399 10" x 14" PL 95395 7" x 10" AL 95398 10" x 14" AL	131645 7" x 10" FB 131646 10" x 14" FB 131643 7" x 10" SS 131644 10" x 14" SS 131641 7" x 10" PL 131642 10" x 14" PL 131639 7" x 10" AL 131640 10" x 14" AL	70852 14" x 20" FB 84036 7" x 10" SS 84037 10" x 14" SS 22075 7" x 10" PL 22076 10" x 14" PL 40639 7" x 10" AL 40640 10" x 14" AL
 <p>DANGER BOILER ROOM AUTHORIZED PERSONNEL ONLY</p>	 <p>DANGER CONTROLLED ACCESS ZONE</p>	 <p>DANGER DO NOT ENTER</p>	 <p>DANGER DO NOT ENTER</p>	 <p>DANGER DO NOT ENTER</p>	 <p>DANGER DO NOT ENTER</p>
69771 10" x 14" FB 84038 7" x 10" SS 84039 10" x 14" SS 22077 7" x 10" PL 22078 10" x 14" PL 40641 7" x 10" AL 40642 10" x 14" AL	124745 7" x 10" SS 124748 10" x 14" SS 124744 7" x 10" PL 124747 10" x 14" PL 124743 7" x 10" AL 124746 10" x 14" AL	70885 7" x 10" FB 122714 10" x 14" FB 87750 3.5" x 5" SS 84571 7" x 10" SS 84572 10" x 14" SS 22433 7" x 10" PL 22434 10" x 14" PL 40997 7" x 10" AL 40998 10" x 14" AL	118162 7" x 10" EcoSS 118163 10" x 14" EcoSS 116106 7" x 10" EcoPL 116107 10" x 14" EcoPL 115943 10" x 14" EcoPaper	131621 7" x 10" FB 131622 10" x 14" FB 131619 7" x 10" SS 131620 10" x 14" SS 131617 7" x 10" PL 131618 10" x 14" PL 131615 7" x 10" AL 131616 10" x 14" AL	69109 7" x 17" FB
 <p>DANGER DO NOT ENTER AUTHORIZED PERSONNEL ONLY</p>	 <p>DANGER DO NOT ENTER AUTHORIZED PERSONNEL ONLY</p>	 <p>DANGER DO NOT ENTER AUTHORIZED PERSONNEL ONLY</p>	 <p>DANGER DO NOT ENTER EMERGENCY EXIT ONLY</p>	 <p>DANGER DO NOT ENTER TEST IN PROGRESS</p>	 <p>DANGER DO NOT ENTER WHEN EQUIPMENT IS OPERATING</p>
69097 10" x 14" FB 84054 7" x 10" SS 84055 10" x 14" SS 22082 10" x 14" PL 40645 7" x 10" AL 40646 10" x 14" AL	118164 7" x 10" EcoSS 118165 10" x 14" EcoSS 116108 7" x 10" EcoPL 116109 10" x 14" EcoPL 115944 7" x 10" EcoPaper 115945 10" x 14" EcoPaper	131629 7" x 10" FB 131630 10" x 14" FB 131627 7" x 10" SS 131628 10" x 14" SS 131625 7" x 10" PL 131626 10" x 14" PL 131623 7" x 10" AL 131624 10" x 14" AL	69111 10" x 14" FB 84056 7" x 10" SS 84057 10" x 14" SS 22083 7" x 10" PL 22084 10" x 14" PL 40647 7" x 10" AL	123619 7" x 10" SS 123622 10" x 14" SS 123618 7" x 10" PL 123621 10" x 14" PL 123617 7" x 10" AL 123620 10" x 14" AL	124757 7" x 10" SS 124760 10" x 14" SS 124756 7" x 10" PL 124759 10" x 14" PL 124755 7" x 10" AL 124758 10" x 14" AL
 <p>DANGER DO NOT ENTER WHEN LIGHTS ARE FLASHING</p>	 <p>DANGER DO NOT ENTER WHEN RED LIGHT IS ON</p>	 <p>DANGER DO NOT ENTER WITHOUT WEARING EAR PROTECTION</p>	 <p>DANGER DO NOT ENTER WITHOUT WEARING PROTECTIVE CLOTHING</p>	 <p>DANGER DO NOT ENTER ELECTRICAL FENCE</p>	
69101 10" x 14" FB 84060 7" x 10" SS 84061 10" x 14" SS 22086 10" x 14" PL 40649 7" x 10" AL 40650 10" x 14" AL	124739 7" x 10" SS 124742 10" x 14" SS 124738 7" x 10" PL 124741 10" x 14" PL 124737 7" x 10" AL 124740 10" x 14" AL	69105 10" x 14" FB 84062 7" x 10" SS 84063 10" x 14" SS 22087 7" x 10" PL 22088 10" x 14" PL	69108 10" x 14" FB 84064 7" x 10" SS 84065 10" x 14" SS 22089 7" x 10" PL 22090 10" x 14" PL 40654 10" x 14" AL	124763 7" x 10" SS 124766 10" x 14" SS 124762 7" x 10" PL 124765 10" x 14" PL 124761 7" x 10" AL 124764 10" x 14" AL	

Admittance Signs

BradyID.com/s36

Admittance Signs (continued)



71543	7" x 10"	FB
71545	10" x 14"	FB
87754	3.5" x 5"	SS
84068	7" x 10"	SS
84069	10" x 14"	SS
22093	7" x 10"	PL
22094	10" x 14"	PL
40657	7" x 10"	AL
40658	10" x 14"	AL



131721	7" x 10"	FB
131722	10" x 14"	FB
131719	7" x 10"	SS
131720	10" x 14"	SS
131717	7" x 10"	PL
131718	10" x 14"	PL
131715	7" x 10"	AL
131716	10" x 14"	AL



95357	7" x 10"	FB
69193	10" x 14"	FB
87755	3.5" x 5"	SS
84066	7" x 10"	SS
84067	10" x 14"	SS
22091	7" x 10"	PL
22092	10" x 14"	PL
40655	7" x 10"	AL
40656	10" x 14"	AL



124769	7" x 10"	SS
124772	10" x 14"	SS
124768	7" x 10"	PL
124771	10" x 14"	PL
124767	7" x 10"	AL
124770	10" x 14"	AL

Sign Selection Guide

- FB - Premium fiberglass (B-120)
- SS - Self-sticking polyester (B-302)
- PL - Plastic (B-401)
- AL - Aluminum (B-555)
- BGSS - BradyGlo™ self-stick polyester (B-324)
- BGPL - BradyGlo™ plastic (B-347)

Material Comparison page 408
Sign Legend Index..... page 588



124751	7" x 10"	SS
124754	10" x 14"	SS
124750	7" x 10"	PL
124753	10" x 14"	PL
124749	7" x 10"	AL
124752	10" x 14"	AL



70330	10" x 14"	FB
85174	10" x 14"	SS
25659	10" x 14"	PL
43236	10" x 14"	AL



124775	7" x 10"	SS
124778	10" x 14"	SS
124774	7" x 10"	PL
124777	10" x 14"	PL
124773	7" x 10"	AL
124776	10" x 14"	AL



69273	10" x 14"	FB
22097	7" x 10"	PL
22098	10" x 14"	PL
40661	7" x 10"	AL
40662	10" x 14"	AL



95407	10" x 14"	FB
70371	14" x 20"	FB
84074	7" x 10"	SS
84075	10" x 14"	SS
22099	7" x 10"	PL
22100	10" x 14"	PL
40663	7" x 10"	AL
40664	10" x 14"	AL



45470	7" x 10"	FB
45471	10" x 14"	FB
45472	14" x 20"	FB
89174	3.25" x 4.5"	SS
84082	3.5" x 5"	SS
84083	7" x 10"	SS
84084	10" x 14"	SS
22103	7" x 10"	PL
22104	10" x 14"	PL
40667	7" x 10"	AL
40668	10" x 14"	AL



131661	7" x 10"	FB
131662	10" x 14"	FB
131659	7" x 10"	SS
131660	10" x 14"	SS
131657	7" x 10"	PL
131658	10" x 14"	PL
131655	7" x 10"	AL



122894	7" x 10"	FB
122756	10" x 14"	FB
71580	14" x 20"	FB
87751	3.5" x 5"	SS
84085	7" x 10"	SS
84086	10" x 14"	SS
22105	7" x 10"	PL
22106	10" x 14"	PL
40669	7" x 10"	AL
40670	10" x 14"	AL



47006	10" x 14"	FB
84089	7" x 10"	SS
84090	10" x 14"	SS
40671	7" x 10"	AL
40672	10" x 14"	AL



124781	7" x 10"	SS
124784	10" x 14"	SS
124780	7" x 10"	PL
124783	10" x 14"	PL
124779	7" x 10"	AL
124782	10" x 14"	AL



124787	7" x 10"	SS
124790	10" x 14"	SS
124786	7" x 10"	PL
124789	10" x 14"	PL
124785	7" x 10"	AL
124788	10" x 14"	AL



47152	7" x 10"	FB
84091	7" x 10"	SS
84092	10" x 14"	SS
22109	7" x 10"	PL
22110	10" x 14"	PL
40673	7" x 10"	AL
40674	10" x 14"	AL



124793	7" x 10"	SS
124796	10" x 14"	SS
124792	7" x 10"	PL
124795	10" x 14"	PL
124791	7" x 10"	AL
124794	10" x 14"	AL



95356	7" x 10"	FB
75478	14" x 20"	FB
47008	10" x 14"	FB
87759	3.5" x 5"	SS
84095	7" x 10"	SS
84096	10" x 14"	SS
22111	7" x 10"	PL
22112	10" x 14"	PL
40675	7" x 10"	AL
40676	10" x 14"	AL



118189	7" x 10"	EcoSS
118188	10" x 14"	EcoSS
116133	7" x 10"	EcoPL
116132	10" x 14"	EcoPL



131653	7" x 10"	FB
131654	10" x 14"	FB
131651	7" x 10"	SS
131652	10" x 14"	SS
131649	7" x 10"	PL
131650	10" x 14"	PL
131647	7" x 10"	AL
131648	10" x 14"	AL



73430	14" x 20"	FB
84097	7" x 10"	SS
22113	7" x 10"	PL
22114	10" x 14"	PL
40677	7" x 10"	AL
40678	10" x 14"	AL



123721	7" x 10"	SS
123724	10" x 14"	SS
123720	7" x 10"	PL
123723	10" x 14"	PL
123719	7" x 10"	AL
123722	10" x 14"	AL



84101	7" x 10"	SS
22115	7" x 10"	PL
22116	10" x 14"	PL
40679	7" x 10"	AL
40680	10" x 14"	AL



124799	7" x 10"	SS
124802	10" x 14"	SS
124798	7" x 10"	PL
124801	10" x 14"	PL
124797	7" x 10"	AL
124800	10" x 14"	AL



95392	10" x 14"	FB
95389	10" x 14"	SS
95391	10" x 14"	PL
95390	10" x 14"	AL



95361	7" x 10"	FB
95365	10" x 14"	FB
132057	7" x 10"	SS
95362	10" x 14"	SS
95359	7" x 10"	PL
95364	10" x 14"	PL
95360	7" x 10"	AL
95363	10" x 14"	AL



123703	10" x 7"	SS
123706	14" x 10"	SS
123702	10" x 7"	PL
123705	14" x 10"	PL
123701	10" x 7"	AL
123704	14" x 10"	AL



70456	7" x 17"	FB
-------	----------	----

Admittance Signs (continued)



69410	10' x 14'	FB
84103	7' x 10'	SS
84104	10' x 14'	SS
22117	7' x 10'	PL
22118	10' x 14'	PL
40681	7' x 10'	AL
40682	10' x 14'	AL



70479	10' x 14'	FB
84107	7' x 10'	SS
84108	10' x 14'	SS
22121	7' x 10'	PL
22122	10' x 14'	PL
40685	7' x 10'	AL
40686	10' x 14'	AL



69473	10' x 14'	FB
84110	10' x 14'	SS
22123	7' x 10'	PL
22124	10' x 14'	PL
40687	7' x 10'	AL
40688	10' x 14'	AL



69461	10' x 14'	FB
84111	7' x 10'	SS
84112	10' x 14'	SS
22125	7' x 10'	PL
22126	10' x 14'	PL
40689	7' x 10'	AL
40690	10' x 14'	AL



84113	7' x 10'	SS
84114	10' x 14'	SS
22127	7' x 10'	PL
22128	10' x 14'	PL
40691	7' x 10'	AL
40692	10' x 14'	AL



95378	7' x 10'	FB
95382	10' x 14'	FB
95375	7' x 10'	SS
95379	10' x 14'	SS
95376	7' x 10'	PL
95381	10' x 14'	PL
95377	7' x 10'	AL
95380	10' x 14'	AL



70565	7' x 17'	FB
-------	----------	----



74391	10' x 14'	FB
84115	7' x 10'	SS
22129	7' x 10'	PL
22130	10' x 14'	PL
40694	10' x 14'	AL



69380	10' x 14'	FB
84119	7' x 10'	SS
84120	10' x 14'	SS
22131	7' x 10'	PL
22132	10' x 14'	PL
40695	7' x 10'	AL
40696	10' x 14'	AL



69382	10' x 14'	FB
84122	10' x 14'	SS
22133	7' x 10'	PL
22134	10' x 14'	PL
40698	10' x 14'	AL



95321	7' x 10'	FB
84123	7' x 10'	SS
84124	10' x 14'	SS
22135	7' x 10'	PL
22136	10' x 14'	PL
40699	7' x 10'	AL
40700	10' x 14'	AL



69387	10' x 14'	FB
22137	7' x 10'	PL
22138	10' x 14'	PL
40702	10' x 14'	AL



40703	7' x 10'	AL
40704	10' x 14'	AL



95214	7' x 10'	FB
95230	10' x 14'	FB
95211	7' x 10'	SS
95212	7' x 10'	PL
95213	7' x 10'	AL
95216	10' x 14'	AL



95278	10' x 14'	FB
95268	7' x 10'	SS
60578	10' x 14'	SS
95275	7' x 10'	PL
60539	10' x 14'	PL
95270	7' x 10'	AL
60510	10' x 14'	AL



73476	7' x 10'	FB
70602	10' x 14'	FB
84129	7' x 10'	SS
84130	10' x 14'	SS
22141	7' x 10'	PL
22142	10' x 14'	PL
40705	7' x 10'	AL
40706	10' x 14'	AL



95284	7' x 17'	FB
95259	10' x 14'	FB
95254	7' x 10'	SS
95258	10' x 14'	SS
95256	7' x 10'	PL
25901	10' x 14'	PL
95255	7' x 10'	AL
43478	10' x 14'	AL



131677	7' x 10'	FB
131678	10' x 14'	FB
131675	7' x 10'	SS
131676	10' x 14'	SS
131673	7' x 10'	PL
131674	10' x 14'	PL
131671	7' x 10'	AL
131672	10' x 14'	AL



124811	7' x 10'	SS
124814	10' x 14'	SS
124810	7' x 10'	PL
124813	10' x 14'	PL
124809	7' x 10'	AL
124812	10' x 14'	AL



124817	7' x 10'	SS
124820	10' x 14'	SS
124816	7' x 10'	PL
124819	10' x 14'	PL
124815	7' x 10'	AL
124818	10' x 14'	AL



131669	7' x 10'	FB
131670	10' x 14'	FB
131667	7' x 10'	SS
131668	10' x 14'	SS
131665	7' x 10'	PL
131666	10' x 14'	PL
131663	7' x 10'	AL
131664	10' x 14'	AL



47327	10' x 14'	FB
84131	7' x 10'	SS
84132	10' x 14'	SS
22143	7' x 10'	PL
22144	10' x 14'	PL
40707	7' x 10'	AL
40708	10' x 14'	AL



69210	10' x 14'	FB
84133	7' x 10'	SS
84134	10' x 14'	SS
22145	7' x 10'	PL
22146	10' x 14'	PL
40709	7' x 10'	AL
40710	10' x 14'	AL



95240	7' x 10'	FB
70667	10' x 14'	FB
84732	7' x 10'	SS
84733	10' x 14'	SS
22537	7' x 10'	PL
22538	10' x 14'	PL
41101	7' x 10'	AL
41102	10' x 14'	AL



124823	7' x 10'	SS
124826	10' x 14'	SS
124822	7' x 10'	PL
124825	10' x 14'	PL
124821	7' x 10'	AL
124824	10' x 14'	AL



124829	7' x 10'	SS
124832	10' x 14'	SS
124828	7' x 10'	PL
124831	10' x 14'	PL
124827	7' x 10'	AL
124830	10' x 14'	AL



122854	7' x 10'	FB
70699	10' x 14'	FB
122654	7' x 10'	SS
84138	10' x 14'	SS
22147	7' x 10'	PL
22148	10' x 14'	PL
40711	7' x 10'	AL
40712	10' x 14'	AL



84140	10' x 14'	SS
22150	10' x 14'	PL
40713	7' x 10'	AL
40714	10' x 14'	AL

Admittance Signs

BradyID.com/s36

Admittance Signs (continued)



84141	7" x 10"	SS
84142	10" x 14"	SS
22151	7" x 10"	PL
22152	10" x 14"	PL
40715	7" x 10"	AL
40716	10" x 14"	AL



95324	7" x 10"	FB
84143	7" x 10"	SS
84144	10" x 14"	SS
40717	7" x 10"	AL
40718	10" x 14"	AL



84146	10" x 14"	SS
22156	10" x 14"	PL
40720	10" x 14"	AL



70713	10" x 14"	FB
84149	7" x 10"	SS
84150	10" x 14"	SS
22157	7" x 10"	PL
22158	10" x 14"	PL
40721	7" x 10"	AL
40722	10" x 14"	AL

Sign Selection Guide

- FB** - Premium fiberglass (B-120)
- SS** - Self-sticking polyester (B-302)
- PL** - Plastic (B-401)
- AL** - Aluminum (B-555)
- BGSS** - BradyGlo™ self-stick polyester (B-324)
- BGPL** - BradyGlo™ plastic (B-347)

Material Comparison page 408
Sign Legend Index..... page 588



25902	10" x 14"	PL
43479	10" x 14"	AL



84908	10" x 14"	SS
23092	10" x 14"	PL
84907	10" x 14"	AL



84151	7" x 10"	SS
84152	10" x 14"	SS
22160	10" x 14"	PL
40723	7" x 10"	AL
40724	10" x 14"	AL



84153	7" x 10"	SS
84154	10" x 14"	SS
22161	7" x 10"	PL
22162	10" x 14"	PL
40725	7" x 10"	AL
40726	10" x 14"	AL



122850	7" x 10"	FB
47330	10" x 14"	FB
75510	14" x 20"	FB
84155	7" x 10"	SS
84156	10" x 14"	SS
22163	7" x 10"	PL
22164	10" x 14"	PL
122412	7" x 10"	AL
40728	10" x 14"	AL



95285	7" x 17"	FB
-------	----------	----



95236	10" x 14"	SS
95233	7" x 10"	PL
95238	10" x 14"	PL
95237	10" x 14"	AL



95283	7" x 10"	FB
95291	10" x 14"	FB
95279	7" x 10"	SS
95288	10" x 14"	SS
95280	7" x 10"	PL
95290	10" x 14"	PL
95281	7" x 10"	AL
95289	10" x 14"	AL



95296	10" x 14"	SS
95293	7" x 10"	PL
95298	10" x 14"	PL
95294	7" x 10"	AL
95297	10" x 14"	AL



84159	7" x 10"	SS
84160	10" x 14"	SS
22166	10" x 14"	PL
40729	7" x 10"	AL
40730	10" x 14"	AL



69446	10" x 14"	FB
22168	10" x 14"	PL
40732	10" x 14"	AL



69447	10" x 14"	FB
40734	10" x 14"	AL



95310	10" x 14"	FB
95300	7" x 10"	SS
95301	7" x 10"	PL
95309	10" x 14"	PL
95305	7" x 10"	AL



95248	10" x 14"	FB
95241	7" x 10"	SS
95245	10" x 14"	SS
95242	7" x 10"	PL
95247	10" x 14"	PL
95243	7" x 10"	AL
95246	10" x 14"	AL



69477	10" x 14"	FB
84167	7" x 10"	SS
84168	10" x 14"	SS
22171	7" x 10"	PL
22172	10" x 14"	PL
40736	10" x 14"	AL



95311	7" x 10"	FB
70522	10" x 14"	FB
84736	7" x 10"	SS
84737	10" x 14"	SS
22541	7" x 10"	PL
22542	10" x 14"	PL
41106	10" x 14"	AL

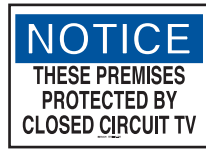

84171	7" x 10"	SS
84172	10" x 14"	SS
22173	7" x 10"	PL
22174	10" x 14"	PL
40737	7" x 10"	AL



124835	7" x 10"	SS
124838	10" x 14"	SS
124834	7" x 10"	PL
124837	10" x 14"	PL
124833	7" x 10"	AL
124836	10" x 14"	AL



95316	7" x 10"	B-120
95312	7" x 10"	B-302
95317	10" x 14"	B-302
95314	7" x 10"	B-401
95419	10" x 14"	B-401
95315	7" x 10"	B-555
95318	10" x 14"	B-555



95263	7" x 10"	FB
95266	10" x 14"	PL
95262	7" x 10"	AL
95265	10" x 14"	AL



70567	14" x 20"	FB
84173	7" x 10"	SS
84174	10" x 14"	SS
22175	7" x 10"	PL
22176	10" x 14"	PL
40739	7" x 10"	AL
40740	10" x 14"	AL



122910	7" x 10"	FB
70220	10" x 14"	FB
84175	7" x 10"	SS
84176	10" x 14"	SS
22177	7" x 10"	PL
22178	10" x 14"	PL
40741	7" x 10"	AL
40742	10" x 14"	AL



84179	7" x 10"	SS
22181	7" x 10"	PL
40746	10" x 14"	AL



71335	10" x 14"	FB
84181	7" x 10"	SS
84182	10" x 14"	SS
22183	7" x 10"	PL
22184	10" x 14"	PL
40747	7" x 10"	AL
40748	10" x 14"	AL

Safety Signs

Admittance Signs (continued)



71229	14' x 20'	FB
84183	7' x 10'	SS
84184	10' x 14'	SS
22185	7' x 10'	PL
22186	10' x 14'	PL
40749	7' x 10'	AL
40750	10' x 14'	AL



71258	14' x 20'	FB
84185	7' x 10'	SS
84186	10' x 14'	SS
22187	7' x 10'	PL
22188	10' x 14'	PL
40751	7' x 10'	AL
40752	10' x 14'	AL



122857	7' x 10'	FB
71389	10' x 14'	FB
87758	3.5' x 5'	SS
84187	7' x 10'	SS
84188	10' x 14'	SS
122525	7' x 10'	PL
22190	10' x 14'	PL
40753	7' x 10'	AL
40754	10' x 14'	AL



123476	7' x 10'	SS
123479	10' x 14'	SS
123475	7' x 10'	PL
123478	10' x 14'	PL
123474	7' x 10'	AL
123477	10' x 14'	AL



69099	10' x 14'	FB
84189	7' x 10'	SS
84190	10' x 14'	SS
22191	7' x 10'	PL
22192	10' x 14'	PL
40755	7' x 10'	AL
40756	10' x 14'	AL



69566	10' x 14'	FB
84191	7' x 10'	SS
84192	10' x 14'	SS
22193	7' x 10'	PL
22194	10' x 14'	PL
40757	7' x 10'	AL
40758	10' x 14'	AL



127070	7' x 10'	SS
127073	10' x 14'	SS
127069	7' x 10'	PL
127072	10' x 14'	PL
127068	7' x 10'	AL
127071	10' x 14'	AL



11089	7' x 10'	FB
11095	10' x 14'	FB
11090	7' x 10'	SSV
26641	7' x 10'	PL
26453	10' x 14'	PL
40194	10' x 14'	AL



69575	10' x 14'	FB
84195	7' x 10'	SS
84196	10' x 14'	SS
22195	7' x 10'	PL
22196	10' x 14'	PL
40759	7' x 10'	AL
40760	10' x 14'	AL



69580	10' x 14'	FB
84197	7' x 10'	SS
84198	10' x 14'	SS
22197	7' x 10'	PL
22198	10' x 14'	PL
40761	7' x 10'	AL
40762	10' x 14'	AL



69591	10' x 14'	FB
84199	7' x 10'	SS
84200	10' x 14'	SS
22199	7' x 10'	PL
22200	10' x 14'	PL
40763	7' x 10'	AL
40764	10' x 14'	AL



69603	10' x 14'	FB
84203	7' x 10'	SS
84204	10' x 14'	SS
22201	7' x 10'	PL
22202	10' x 14'	PL
40765	7' x 10'	AL
40766	10' x 14'	AL



69606	10' x 14'	FB
84205	7' x 10'	SS
84206	10' x 14'	SS
22203	7' x 10'	PL
22204	10' x 14'	PL
40767	7' x 10'	AL
40768	10' x 14'	AL



69612	10' x 14'	FB
84207	7' x 10'	SS
84208	10' x 14'	SS
22205	7' x 10'	PL
22206	10' x 14'	PL
40769	7' x 10'	AL
40770	10' x 14'	AL



143631	14' x 10'	AL
--------	-----------	----



140871	14' x 10'	AL
--------	-----------	----

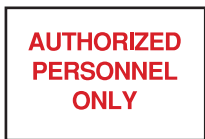

122851	7' x 10'	FB
70833	10' x 14'	FB
84212	7' x 10'	SS
84213	10' x 14'	SS
22207	7' x 10'	PL
22208	10' x 14'	PL
122413	7' x 10'	AL
40772	10' x 14'	AL



122907	7' x 10'	FB
122768	10' x 14'	FB
84211	4.5' x 10'	SS
122697	7' x 10'	SS
122620	10' x 14'	SS
122560	7' x 10'	PL
122497	10' x 14'	PL
122456	7' x 10'	AL
122385	10' x 14'	AL

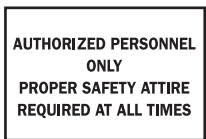

70846	14' x 20'	FB
84215	10' x 14'	SS
22209	7' x 10'	PL
22210	10' x 14'	PL
40773	7' x 10'	AL
40774	10' x 14'	AL



122868	7' x 10'	FB
70632	10' x 14'	FB
80037	7' x 10'	SS
122622	10' x 14'	SS
25977	7' x 10'	PL
25978	10' x 14'	PL
122459	7' x 10'	AL
43906	10' x 14'	AL

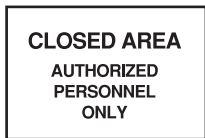

122852	7' x 10'	FB
70863	10' x 14'	FB
84218	7' x 10'	SS
84219	10' x 14'	SS
22213	7' x 10'	PL
22214	10' x 14'	PL
122414	7' x 10'	AL
40778	10' x 14'	AL



22216	10' x 14'	PL
40780	10' x 14'	AL



69096	10' x 14'	FB
87757	3.5' x 5'	SS
84222	7' x 10'	SS
84223	10' x 14'	SS
22217	7' x 10'	PL
22218	10' x 14'	PL
40781	7' x 10'	AL



95442	10' x 14'	PL
-------	-----------	----



84226	7' x 10'	SS
84227	10' x 14'	SS
22219	7' x 10'	PL



95443	10' x 14'	PL
-------	-----------	----

Admittance Signs

BradyID.com/s36

Admittance Signs (continued)

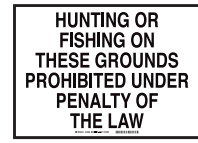

69032 10' x 14' FB
43356 10' x 14' AL



84236 5' x 14' SS
22220 7' x 10' PL



71136 10' x 14' FB
84237 7' x 10' SS
84238 10' x 14' SS
22221 7' x 10' PL
22222 10' x 14' PL
40785 7' x 10' AL
40786 10' x 14' AL



123458 7' x 10' SS
123461 10' x 14' SS
123457 7' x 10' PL
123460 10' x 14' PL
123456 7' x 10' AL
123459 10' x 14' AL

Sign Selection Guide

FB - Premium fiberglass (B-120)
SS - Self-sticking polyester (B-302)
PL - Plastic (B-401)
AL - Aluminum (B-555)
BGSS - BradyGlo™ self-stick polyester (B-324)
BGPL - BradyGlo™ plastic (B-347)

Material Comparison page 408
Sign Legend Index..... page 588



71142 20' x 28' FB
84239 7' x 10' SS
84240 10' x 14' SS
22224 10' x 14' PL
40788 10' x 14' AL



124805 7' x 10' SS
124808 10' x 14' SS
124804 7' x 10' PL
124807 10' x 14' PL
124803 7' x 10' AL
124806 10' x 14' AL



123550 14' x 10' SS
123547 10' x 7' SS
123549 14' x 10' PL
123546 10' x 7' PL
123548 14' x 10' AL
123545 10' x 7' AL



123556 14' x 10' SS
123553 10' x 7' SS
123555 14' x 10' PL
123552 10' x 7' PL
123554 14' x 10' AL
123551 10' x 7' AL



69793 7' x 7' FB
88517 7' x 7' SS
25179 7' x 10' PL
42756 7' x 10' AL



123513 14' x 10' SS
123510 10' x 7' SS
123512 14' x 10' PL
123509 10' x 7' PL
123511 14' x 10' AL
123508 10' x 7' AL



123544 14' x 10' SS
123541 10' x 7' SS
123543 14' x 10' PL
123540 10' x 7' PL
123542 14' x 10' AL
123539 10' x 7' AL



84245 7' x 10' SS
84246 10' x 14' SS
22225 7' x 10' PL
22226 10' x 14' PL
40789 7' x 10' AL
40790 10' x 14' AL



123504 7' x 10' SS
123507 10' x 14' SS
123503 7' x 10' PL
123506 10' x 14' PL
123502 7' x 10' AL
123505 10' x 14' AL



95445 10' x 14' PL

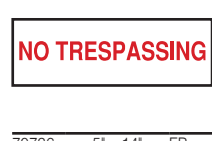

70736 5' x 14' FB
122800 7' x 10' FB
122708 10' x 14' FB
84247 5' x 14' SS
122639 7' x 10' SS
122568 10' x 14' SS
122470 10' x 14' PL
40791 7' x 10' AL
122344 10' x 14' AL

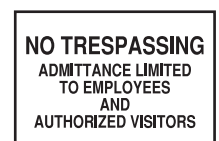

71199 20' x 28' FB
84249 10' x 14' SS
22228 7' x 10' PL
22229 10' x 14' PL
40792 7' x 10' AL
40793 10' x 14' AL

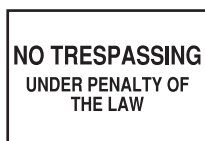

69405 10' x 14' FB
84251 10' x 14' SS
40795 10' x 14' AL



122801 7' x 10' FB
122709 10' x 14' FB
71216 14' x 20' FB
84252 7' x 10' SS
122569 10' x 14' SS
22232 7' x 10' PL
22233 10' x 14' PL
40796 7' x 10' AL
40797 10' x 14' AL



95446 10' x 14' PL



70747 10' x 14' FB
22234 7' x 10' PL
40798 7' x 10' AL
40799 10' x 14' AL



124865 7' x 10' SS
124868 10' x 14' SS
124864 7' x 10' PL
124867 10' x 14' PL
124863 7' x 10' AL
124866 10' x 14' AL



73469 14' x 10' FB
84257 14' x 10' SS
84256 10' x 7' SS
22237 14' x 10' PL
22236 10' x 7' PL
40801 14' x 10' AL
40800 10' x 7' AL



124871 7' x 10' SS
124874 10' x 14' SS
124870 7' x 10' PL
124873 10' x 14' PL
124869 7' x 10' AL
124872 10' x 14' AL

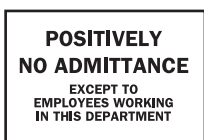

84258 7' x 10' SS
84259 10' x 14' SS
40803 10' x 14' AL



69449 7' x 10' FB
84260 7' x 10' SS
22241 10' x 14' PL
40805 10' x 14' AL



70753 10' x 14' FB
84263 10' x 14' SS
40806 7' x 10' AL
40807 10' x 14' AL



69445 10' x 14' FB
40808 7' x 10' AL
40809 10' x 14' AL



124847 7' x 10' SS
124850 10' x 14' SS
124846 7' x 10' PL
124849 10' x 14' PL
124845 7' x 10' AL
124848 10' x 14' AL

Safety Signs

Admittance Signs (continued)



84266	7' x 10'	SS
84267	10' x 14'	SS
22246	7' x 10'	PL
22247	10' x 14'	PL
40810	7' x 10'	AL
40811	10' x 14'	AL



124853	7' x 10'	SS
124856	10' x 14'	SS
124852	7' x 10'	PL
124855	10' x 14'	PL
124851	7' x 10'	AL
124854	10' x 14'	AL



122883	7' x 10'	FB
122744	10' x 14'	FB
71282	14' x 20'	FB
122679	7' x 10'	SS
122602	10' x 14'	SS
122548	7' x 10'	PL
122485	10' x 14'	PL
122439	7' x 10'	AL
122370	10' x 14'	AL



124892	24' x 24'	SS
124889	18' x 18'	SS
124891	24' x 24'	PL
124888	18' x 18'	PL
124890	24' x 24'	AL
124887	18' x 18'	AL



124841	7' x 10'	SS
124844	10' x 14'	SS
124840	7' x 10'	PL
124843	10' x 14'	PL
124839	7' x 10'	AL
124842	10' x 14'	AL



124859	7' x 10'	SS
124862	10' x 14'	SS
124858	7' x 10'	PL
124861	10' x 14'	PL
124857	7' x 10'	AL
124860	10' x 14'	AL



122884	7' x 10'	FB
71293	10' x 14'	FB
71288	14' x 20'	FB
122680	7' x 10'	SS
84269	10' x 14'	SS
22248	7' x 10'	PL
22249	10' x 14'	PL
40812	7' x 10'	AL
40813	10' x 14'	AL



123464	7' x 10'	SS
123467	10' x 14'	SS
123463	7' x 10'	PL
123466	10' x 14'	PL
123462	7' x 10'	AL
123465	10' x 14'	AL



84270	7' x 10'	SS
22251	10' x 14'	PL
40815	10' x 14'	AL



123498	10' x 7'	SS
123501	14' x 10'	SS
123497	10' x 7'	PL
123500	14' x 10'	PL
123496	10' x 7'	AL
123499	14' x 10'	AL



69448	10' x 14'	FB
-------	-----------	----



84274	7' x 10'	SS
84275	10' x 14'	SS
22254	7' x 10'	PL
22255	10' x 14'	PL
40818	7' x 10'	AL
40819	10' x 14'	AL



71326	14' x 20'	FB
84276	7' x 10'	SS
84277	10' x 14'	SS
22256	7' x 10'	PL
40820	7' x 10'	AL



71313	5' x 14'	FB
84278	5' x 14'	SS



84279	7' x 10'	SS
22257	7' x 10'	PL
22258	10' x 14'	PL
40821	7' x 10'	AL



124877	7' x 10'	SS
124880	10' x 14'	SS
124876	7' x 10'	PL
124879	10' x 14'	PL
124875	7' x 10'	AL
124878	10' x 14'	AL



95447	10' x 14'	PL
-------	-----------	----



124883	7' x 10'	SS
124886	10' x 14'	SS
124882	7' x 10'	PL
124885	10' x 14'	PL
124881	7' x 10'	AL
124884	10' x 14'	AL



95448	10' x 14'	PL
-------	-----------	----



71396	14' x 20'	FB
84284	10' x 14'	SS
22260	7' x 10'	PL
22261	10' x 14'	PL
40825	10' x 14'	AL



123491	10' x 7'	SS
123494	14' x 10'	SS
123490	10' x 7'	PL
123493	14' x 10'	PL
123489	10' x 7'	AL
123492	14' x 10'	AL



123470	7' x 10'	SS
123473	10' x 14'	SS
123469	7' x 10'	PL
123472	10' x 14'	PL
123468	7' x 10'	AL
123471	10' x 14'	AL

ANSI Signs

BradyID.com/s36







ANSI Z535 Signs

Brady offers a variety of ANSI safety signs to help you prevent accidents and enhance productivity and safety within your facility. ANSI signs are highly visible and provide recognizable safety alert messages for workplace caution, warning, notice, danger and more. Brady's ANSI signs adhere to ANSI Z535.1, Z535.2 and Z535.5 safety standards for colors and symbols and can be understood by employees and visitors of all cultural backgrounds.

Sign Selection Guide





FB - Premium fiberglass (B-120)
SS - Self-sticking polyester (B-302)
PL - Plastic (B-401)
AL - Aluminum (B-555)
BGSS - BradyGlo™ self-stick polyester (B-324)
BGPL - BradyGlo™ plastic (B-347)

Material Comparison page 408
Sign Legend Index..... page 588

					
144791 7" x 10" SS	144816 7" x 10" SS	144336 7" x 10" SS	144844 7" x 10" SS	144833 10" x 14" FB	144348 10" x 14" FB
144792 10" x 14" SS	144817 10" x 14" SS	144347 10" x 14" SS	144845 10" x 14" SS	144836 7" x 10" SS	144349 7" x 10" SS
144793 7" x 10" PL	144818 7" x 10" PL	144337 7" x 10" PL	144840 7" x 10" PL	144837 10" x 14" SS	144350 10" x 14" SS
144794 10" x 14" PL	144815 10" x 14" PL	144338 10" x 14" PL	144841 10" x 14" PL	144834 7" x 10" PL	144351 7" x 10" PL
144795 7" x 10" AL	144819 7" x 10" AL	144339 7" x 10" AL	144842 7" x 10" AL	144835 10" x 14" PL	144352 10" x 14" PL
144796 10" x 14" AL	144820 10" x 14" AL	144340 10" x 14" AL	144843 10" x 14" AL	144838 7" x 10" AL	144353 7" x 10" AL
				144839 10" x 14" AL	144354 10" x 14" AL

					
144600 7" x 10" SS	144589 10" x 14" FB	144160 7" x 10" SS	143867 7" x 10" SS	144529 7" x 10" SS	144171 7" x 10" SS
144598 7" x 10" PL	144601 10" x 14" SS	144163 10" x 14" SS	143868 10" x 14" SS	144528 10" x 14" SS	144174 10" x 14" SS
144597 7" x 10" AL	144599 10" x 14" PL	144161 7" x 10" PL	143866 7" x 10" PL	144527 7" x 10" PL	144173 7" x 10" PL
	144590 10" x 14" AL	144158 10" x 14" PL	143865 10" x 14" PL	144531 10" x 14" PL	144170 10" x 14" PL
		144159 7" x 10" AL	143869 7" x 10" AL	144530 7" x 10" AL	144175 7" x 10" AL
		144162 10" x 14" AL	143870 10" x 14" AL	144526 10" x 14" AL	144172 10" x 14" AL

					
144859 7" x 10" SS	144180 10" x 14" FB	144893 10" x 14" FB	143937 7" x 10" SS	144918 7" x 10" SS	144952 7" x 10" SS
144860 10" x 14" SS	144178 7" x 10" SS	144892 7" x 10" SS	143936 10" x 14" SS	144919 10" x 14" SS	144950 10" x 14" SS
144861 7" x 10" PL	144182 10" x 14" SS	144894 10" x 14" SS	143935 7" x 10" PL	144920 7" x 10" PL	144951 7" x 10" PL
144862 10" x 14" PL	144176 7" x 10" PL	144895 7" x 10" PL	143933 10" x 14" PL	144921 10" x 14" PL	144949 10" x 14" PL
144863 7" x 10" AL	144179 10" x 14" PL	144896 10" x 14" PL	143934 7" x 10" AL	144922 7" x 10" AL	144953 7" x 10" AL
144858 10" x 14" AL	144177 7" x 10" AL	144897 7" x 10" AL	143932 10" x 14" AL	144923 10" x 14" AL	144954 10" x 14" AL
	144181 10" x 14" AL	144898 10" x 14" AL			

			
143731 7" x 10" SS	45033 10" x 7" FB	143747 7" x 10" SS	143746 10" x 14" FB
143748 10" x 14" SS	45102 14" x 10" PL	143740 10" x 14" SS	
143752 7" x 10" PL	49021 10" x 7" AL	143750 7" x 10" AL	
143751 10" x 14" PL		143743 10" x 14" AL	
143749 10" x 14" AL			

Safety Signs

ANSI sign standard increases comprehension and safety



Previous standard



Redesigned to:



New standard

Design includes:

1. A safety alert symbol in the header
2. Text statements that communicate:
 - the hazard
 - the possible consequences
 - how to avoid the hazard
3. More visual pictograms



144191 7" x 10" FB
144222 7" x 10" SS
144225 10" x 14" PL
144195 10" x 14" SS
144223 7" x 10" PL
144224 7" x 10" AL
144227 10" x 14" AL



143952 7" x 10" SS
143953 10" x 14" SS
143950 7" x 10" PL
143951 10" x 14" PL
143954 7" x 10" AL
143955 10" x 14" AL



144221 7" x 10" FB
144226 10" x 14" SS



45039 10" x 7" FB
45040 14" x 10" FB
45175 10" x 7" SS
45176 14" x 10" SS
45107 10" x 7" PL
45108 14" x 10" PL
49027 10" x 7" AL



143957 3.5" x 5" SS
143960 10" x 14" PL



144234 10" x 14" FB
144236 7" x 10" SS
144240 10" x 14" SS
144238 7" x 10" PL
144235 10" x 14" PL
144237 7" x 10" AL
144239 10" x 14" AL



144241 20" x 14" FB
144243 10" x 7" SS
144246 14" x 10" SS
144244 10" x 7" PL
144245 14" x 10" PL
144242 10" x 7" AL
144247 14" x 10" AL



144261 7" x 10" FB
144265 10" x 14" SS
144259 7" x 10" PL
144262 10" x 14" PL
144260 7" x 10" AL
144263 10" x 14" AL



144266 14" x 10" FB
144267 10" x 7" SS
144268 14" x 10" SS
144269 10" x 7" PL
144270 14" x 10" PL
144271 10" x 7" AL
144272 14" x 10" AL



144275 7" x 10" SS
144276 10" x 14" SS
144274 7" x 10" PL
144273 10" x 14" PL
144277 7" x 10" AL
144278 10" x 14" AL



144283 7" x 10" SS
144282 10" x 14" SS
144281 7" x 10" PL
144279 10" x 14" PL
144284 7" x 10" AL
144280 10" x 14" AL



144286 7" x 10" SS
144287 10" x 14" SS
144285 7" x 10" PL
144289 10" x 14" PL
144290 7" x 10" AL
144288 10" x 14" AL



144294 7" x 10" SS
144295 10" x 14" SS
144293 7" x 10" PL
144292 10" x 14" PL
144296 7" x 10" AL
144291 10" x 14" AL



144299 20" x 14" FB
144303 10" x 7" SS
144301 14" x 10" SS
144300 10" x 7" PL
144305 14" x 10" PL
144302 10" x 7" AL
144298 14" x 10" AL



144312 7" x 10" SS
144313 10" x 14" SS
144314 7" x 10" PL
144315 10" x 14" PL
144316 7" x 10" AL
144317 10" x 14" AL



144989 7" x 10" SS
144990 10" x 14" SS
144991 7" x 10" PL
144988 10" x 14" PL
144993 7" x 10" AL
144992 10" x 14" AL



45008 14" x 10" FB
45143 10" x 7" SS
45144 14" x 10" SS
45075 10" x 7" PL
45076 14" x 10" PL
48995 10" x 7" AL
48996 14" x 10" AL



62809 10" x 14" FB
83925 3.5" x 5" SS
21797 7" x 10" PL
26572 10" x 14" PL
46473 7" x 10" AL
46750 10" x 14" AL



144121 7" x 10" SS
144122 10" x 14" SS



144142 7" x 10" SS
144143 10" x 14" SS
144138 7" x 10" PL
144141 10" x 14" PL
144140 7" x 10" AL
144139 10" x 14" AL



144714 7" x 10" SS
144715 10" x 14" SS
144712 7" x 10" PL
144713 10" x 14" PL
144716 7" x 10" AL
144717 10" x 14" AL



122905 7" x 10" FB
62738 10" x 14" FB
83887 3.5" x 5" SS
83664 7" x 10" SS
21713 7" x 10" PL
26534 10" x 14" PL
122454 7" x 10" AL
46674 10" x 14" AL



62551 7" x 10" FB
62813 10" x 14" FB
83929 3.5" x 5" SS
83754 7" x 10" SS
21801 7" x 10" PL
26576 10" x 14" PL
46477 7" x 10" AL
46754 10" x 14" AL



145071 7" x 10" SS
145073 10" x 14" SS
145074 7" x 10" PL
145075 10" x 14" PL
145072 7" x 10" AL
145070 10" x 14" AL

ANSI Signs

BradyID.com/s36

ANSI Signs (continued)



44989	10" x 7"	FB
44990	14" x 10"	FB
45125	10" x 7"	SS
45126	14" x 10"	SS
45057	10" x 7"	PL
45058	14" x 10"	PL
48977	10" x 7"	AL
48978	14" x 10"	AL



145118	7" x 10"	SS
145116	10" x 14"	SS
145120	7" x 10"	PL
145119	10" x 14"	PL
145115	7" x 10"	AL
145117	10" x 14"	AL



145124	7" x 10"	SS
145125	10" x 14"	SS
145126	7" x 10"	PL
145127	10" x 14"	PL
145123	7" x 10"	AL
145122	10" x 14"	AL



62545	7" x 10"	FB
62807	10" x 14"	FB
83923	3.5" x 5"	SS
83748	7" x 10"	SS
122611	10" x 14"	SS
21795	7" x 10"	PL
26570	10" x 14"	PL
46471	7" x 10"	AL
46748	10" x 14"	AL

Sign Selection Guide

FB - Premium fiberglass (B-120)
 SS - Self-sticking polyester (B-302)
 PL - Plastic (B-401)
 AL - Aluminum (B-555)
 BGSS - BradyGlo™ self-stick polyester (B-324)
 BGPL - BradyGlo™ plastic (B-347)

Material Comparison page 408
 Sign Legend Index..... page 588



45004	14" x 10"	FB
45139	10" x 7"	SS
45140	14" x 10"	SS
45071	10" x 7"	PL
45072	14" x 10"	PL
48991	10" x 7"	AL
48992	14" x 10"	AL



144128	7" x 10"	SS
144130	10" x 14"	SS
144126	7" x 10"	PL
144127	10" x 14"	PL
144129	7" x 10"	AL
144131	10" x 14"	AL



143830	7" x 10"	PL
143829	10" x 14"	AL



143847	7" x 10"	SS
143848	10" x 14"	SS
143849	7" x 10"	PL
143850	10" x 14"	PL
143846	7" x 10"	AL
143851	10" x 14"	AL



143816	3.5" x 5"	SS
143817	7" x 10"	SS
143821	10" x 14"	SS
143819	7" x 10"	PL
143822	10" x 14"	PL
143818	7" x 10"	AL
143820	10" x 14"	AL



62538	7" x 10"	FB
122754	10" x 14"	FB
83916	3.5" x 5"	SS
83741	7" x 10"	SS
122689	7" x 10"	SS
21788	7" x 10"	PL
26563	10" x 14"	PL
46464	7" x 10"	AL
46741	10" x 14"	AL



143859	7" x 10"	PL
143860	10" x 14"	PL
143863	7" x 10"	SS
143864	10" x 14"	SS
143862	7" x 10"	AL
143861	10" x 14"	AL



144427	7" x 10"	SS
144429	10" x 14"	SS
144428	7" x 10"	PL
144430	10" x 14"	PL
144431	7" x 10"	AL
144432	10" x 14"	AL



144433	10" x 7"	SS
144434	14" x 10"	SS
144435	10" x 7"	PL
144436	14" x 10"	PL
144437	10" x 7"	AL
144438	14" x 10"	AL



144534	7" x 10"	SS
144535	10" x 14"	SS
144533	7" x 10"	PL
144532	10" x 14"	PL
144536	7" x 10"	AL
144537	10" x 14"	AL



144494	10" x 7"	FB
144497	5" x 3.5"	SS
144499	10" x 7"	SS
144498	14" x 10"	SS
144500	10" x 7"	PL
144495	14" x 10"	PL
144502	10" x 7"	AL
144496	14" x 10"	AL



144450	7" x 10"	SS
144451	10" x 14"	SS
144448	7" x 10"	PL
144446	10" x 14"	PL
144449	7" x 10"	AL
144447	10" x 14"	AL



143989	7" x 10"	SS
143992	10" x 14"	SS
143991	7" x 10"	PL
143994	10" x 14"	PL
143990	7" x 10"	AL
143993	10" x 14"	AL



144000	10" x 14"	FB
144002	3.5" x 5"	SS
143999	7" x 10"	SS
143995	10" x 14"	SS
143998	7" x 10"	PL
143996	10" x 14"	PL
143997	7" x 10"	AL
144001	10" x 14"	AL



45031	10" x 7"	FB
45032	14" x 10"	FB
45167	10" x 7"	SS
45168	14" x 10"	SS
45099	10" x 7"	PL
45100	14" x 10"	PL
49019	10" x 7"	AL
49020	14" x 10"	AL



144562	7" x 10"	SS
144563	10" x 14"	SS
144564	7" x 10"	PL
144565	10" x 14"	PL
144566	7" x 10"	AL
144567	10" x 14"	AL



143765	14" x 20"	FB
143769	7" x 10"	SS
143768	10" x 14"	SS
143766	7" x 10"	PL
143767	10" x 14"	PL
143770	7" x 10"	AL
143771	10" x 14"	AL



144718	7" x 10"	SS
144719	10" x 14"	SS
144720	7" x 10"	PL
144721	10" x 14"	PL
144722	7" x 10"	AL
144723	10" x 14"	AL



143701	7" x 10"	SS
143702	10" x 14"	SS
143704	7" x 10"	PL
143703	10" x 14"	PL
143706	7" x 10"	AL
143705	10" x 14"	AL



145199	10" x 14"	FB
145198	7" x 10"	SS
145202	10" x 14"	SS
145201	7" x 10"	PL
145204	10" x 14"	PL
145200	7" x 10"	AL
145203	10" x 14"	AL



144724	7" x 10"	SS
144725	10" x 14"	SS
144726	7" x 10"	PL
144727	10" x 14"	PL
144728	7" x 10"	AL
144729	10" x 14"	AL



144324	7" x 10"	SS
144325	10" x 14"	SS
144326	7" x 10"	PL
144327	10" x 14"	PL
144328	7" x 10"	AL
144329	10" x 14"	AL



144025	10" x 14"	FB
144028	7" x 10"	SS
144029	10" x 14"	SS
144026	7" x 10"	PL
144023	10" x 14"	PL
144027	7" x 10"	AL
144024	10" x 14"	AL

Safety Signs

ANSI Signs (continued)



143889	10" x 7"	SS
143890	14" x 10"	SS
143887	10" x 7"	PL
143888	14" x 10"	PL
143886	10" x 7"	AL
143885	14" x 10"	AL



122830	7" x 10"	FB
62734	10" x 14"	FB
83883	3.5" x 5"	SS
83660	7" x 10"	SS
122575	10" x 14"	SS
21709	7" x 10"	PL
26530	10" x 14"	PL
46626	7" x 10"	AL
46670	10" x 14"	AL



143912	3.5" x 5"	SS
--------	-----------	----



145222	7" x 10"	SS
145220	10" x 14"	SS
145223	7" x 10"	PL
145224	10" x 14"	PL
145221	7" x 10"	AL
145219	10" x 14"	AL

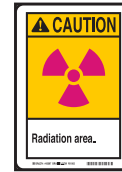

45029	10" x 7"	FB
45165	10" x 7"	SS
45166	14" x 10"	SS
45097	10" x 7"	PL
49017	10" x 7"	AL
49018	14" x 10"	AL



45025	10" x 7"	FB
45026	14" x 10"	FB
45161	10" x 7"	SS
45162	14" x 10"	SS
45093	10" x 7"	PL
45094	14" x 10"	PL
49013	10" x 7"	AL
49014	14" x 10"	AL



145240	7" x 10"	SS
145241	10" x 14"	SS
145238	7" x 10"	PL
145239	10" x 14"	PL
145242	7" x 10"	AL
145243	10" x 14"	AL



45041	10" x 7"	FB
45042	14" x 10"	FB
45177	10" x 7"	SS
45178	14" x 10"	SS
45109	10" x 7"	PL
45110	14" x 10"	PL
49029	10" x 7"	AL
49030	14" x 10"	AL



144754	7" x 10"	SS
144751	10" x 14"	SS
144753	7" x 10"	PL
144750	10" x 14"	PL
144755	7" x 10"	AL
144752	10" x 14"	AL



144758	10" x 14"	FB
144761	7" x 10"	SS
144762	10" x 14"	SS
144759	7" x 10"	PL
144756	10" x 14"	PL
144757	7" x 10"	AL
144760	10" x 14"	AL



144523	10" x 7"	SS
144521	14" x 10"	SS
144524	10" x 7"	PL
144525	14" x 10"	PL
144522	10" x 7"	AL
144520	14" x 10"	AL



143896	7" x 10"	SS
143894	10" x 14"	SS
143892	7" x 10"	PL
143891	10" x 14"	PL
143895	7" x 10"	AL
143893	10" x 14"	AL



143902	7" x 10"	SS
143900	10" x 14"	SS
143898	7" x 10"	PL
143897	10" x 14"	PL
143901	7" x 10"	AL
143899	10" x 14"	AL



143921	7" x 10"	SS
143920	10" x 14"	SS
143922	7" x 10"	PL
143923	10" x 14"	PL
143924	7" x 10"	AL
143925	10" x 14"	AL



144508	5" x 3.5"	SS
144504	7" x 5"	SS
144511	10" x 7"	SS
144506	14" x 10"	SS
144512	10" x 7"	PL
144509	14" x 10"	PL
144513	10" x 7"	AL
144510	14" x 10"	AL



144763	10" x 14"	FB
144764	7" x 10"	SS
144765	10" x 14"	SS
144766	7" x 10"	PL
144767	10" x 14"	PL
144768	7" x 10"	AL
144769	10" x 14"	AL



144789	7" x 10"	SS
144790	10" x 14"	SS
144785	7" x 10"	PL
144787	10" x 14"	PL
144786	7" x 10"	AL
144788	10" x 14"	AL



145265	7" x 10"	SS
145264	10" x 14"	SS
145262	7" x 10"	PL
145263	10" x 14"	PL
145267	7" x 10"	AL
145266	10" x 14"	AL



144093	7" x 10"	SS
144094	10" x 14"	SS
144091	7" x 10"	PL
144089	10" x 14"	PL
144092	7" x 10"	AL
144090	10" x 14"	AL



144095	7" x 17"	FB
--------	----------	----



144098	7" x 10"	SS
144099	10" x 14"	SS
144097	7" x 10"	PL
144096	10" x 14"	PL
144100	7" x 10"	AL
144101	10" x 14"	AL



143905	7" x 10"	SS
143906	10" x 14"	SS
143907	7" x 10"	PL
143908	10" x 14"	PL
143903	7" x 10"	AL
143904	10" x 14"	AL



144109	7" x 10"	SS
144110	10" x 14"	SS
144111	7" x 10"	PL
144108	10" x 14"	PL
144112	7" x 10"	AL
144113	10" x 14"	AL



83931	3.5" x 5"	SS
83756	7" x 10"	SS
21803	7" x 10"	PL
26578	10" x 14"	PL
46479	7" x 10"	AL
46756	10" x 14"	AL



144778	7" x 17"	FB
--------	----------	----



144773	10" x 14"	FB
144777	3.5" x 5"	SS
144775	7" x 10"	SS
144772	10" x 14"	SS
144774	7" x 10"	PL
144770	10" x 14"	PL
144776	7" x 10"	AL
144771	10" x 14"	AL



145279	7" x 10"	SS
145278	10" x 14"	SS
145276	7" x 10"	PL
145277	10" x 14"	PL
145275	7" x 10"	AL
145274	10" x 14"	AL



62816	10" x 14"	FB
83932	3.5" x 5"	SS
83757	7" x 10"	SS
21804	7" x 10"	PL
26579	10" x 14"	PL
46480	7" x 10"	AL
46757	10" x 14"	AL



145289	7" x 10"	SS
145288	10" x 14"	SS
145291	7" x 10"	PL
145290	10" x 14"	PL
145287	7" x 10"	AL
145286	10" x 14"	AL

ANSI Signs

BradyID.com/s36

ANSI Signs (continued)



144780	7" x 10"	SS
144781	10" x 14"	SS
144779	7" x 10"	PL
144782	10" x 14"	PL
144783	7" x 10"	AL
144784	10" x 14"	AL



143910	10" x 14"	B-946
143909	14" x 10"	B-946



125912	10" x 7"	SS
125915	14" x 10"	SS
125911	10" x 7"	PL
125914	14" x 10"	PL
125910	10" x 7"	AL
125913	14" x 10"	AL



124213	10" x 7"	SS
124216	14" x 10"	SS
124212	10" x 7"	PL
124215	14" x 10"	PL
124211	10" x 7"	AL
124214	14" x 10"	AL

Sign Selection Guide

FB - Premium fiberglass (B-120)
SS - Self-sticking polyester (B-302)
PL - Plastic (B-401)
AL - Aluminum (B-555)
BGSS - BradyGlo™ self-stick polyester (B-324)
BGPL - BradyGlo™ plastic (B-347)

Material Comparison page 408
Sign Legend Index..... page 588



128624	10" x 7"	SS
128627	14" x 10"	SS
128623	10" x 7"	PL
128626	14" x 10"	PL
128622	10" x 7"	AL
128625	14" x 10"	AL



144330	7" x 10"	SS
144331	10" x 14"	SS
144332	7" x 10"	PL
144333	10" x 14"	PL
144334	7" x 10"	AL
144335	10" x 14"	AL



45023	10" x 7"	FB
45024	14" x 10"	FB
45159	10" x 7"	SS
45091	10" x 7"	PL
45092	14" x 10"	PL
49011	10" x 7"	AL



143647	7" x 10"	SS
143648	10" x 14"	SS
143644	7" x 10"	PL
143646	10" x 14"	PL
143645	7" x 10"	AL
143643	10" x 14"	AL



143650	7" x 10"	SS
143649	10" x 14"	SS
143653	7" x 10"	PL
143651	10" x 14"	PL
143654	7" x 10"	AL
143652	10" x 14"	AL



144797	7" x 10"	SS
144798	10" x 14"	SS
144799	7" x 10"	PL
144800	10" x 14"	PL
144801	7" x 10"	AL
144802	10" x 14"	AL



144803	7" x 10"	SS
144804	10" x 14"	SS
144805	7" x 10"	PL
144806	10" x 14"	PL
144807	7" x 10"	AL
144808	10" x 14"	AL



144813	7" x 10"	SS
144810	10" x 14"	SS
144814	7" x 10"	PL
144811	10" x 14"	PL
144812	7" x 10"	AL
144809	10" x 14"	AL



144341	7" x 10"	SS
144342	10" x 14"	SS
144343	7" x 10"	PL
144344	10" x 14"	PL
144345	7" x 10"	AL
144346	10" x 14"	AL



144821	20" x 14"	FB
144828	10" x 7"	SS
144825	14" x 10"	SS
144827	10" x 7"	PL
144824	14" x 10"	PL
144826	10" x 7"	AL
144823	14" x 10"	AL



144829	7" x 10"	SS
144830	10" x 14"	SS
144822	7" x 10"	PL
144851	10" x 14"	PL
144832	10" x 14"	AL



144850	7" x 10"	PL
144847	10" x 14"	AL



144592	7" x 10"	SS
144588	7" x 10"	PL
144591	7" x 10"	AL



144593	10" x 14"	SS
144594	10" x 14"	PL
144596	10" x 14"	AL



144168	7" x 10"	SS
144169	10" x 14"	SS
144165	7" x 10"	PL
144164	10" x 14"	PL
144167	7" x 10"	AL
144166	10" x 14"	AL



144355	14" x 20"	FB
--------	-----------	----



144358	7" x 10"	SS
144359	10" x 14"	SS
144360	7" x 10"	PL
144361	10" x 14"	PL
144357	7" x 10"	AL
144356	10" x 14"	AL



144852	7" x 10"	SS
144853	10" x 14"	SS
144854	7" x 10"	PL
144855	10" x 14"	PL
144856	7" x 10"	AL
144857	10" x 14"	AL



144865	10" x 14"	FB
144864	7" x 10"	SS
144866	10" x 14"	SS
144867	7" x 10"	PL
144868	10" x 14"	PL
144869	7" x 10"	AL
144870	10" x 14"	AL



144871	7" x 10"	SS
144872	10" x 14"	SS
144873	7" x 10"	PL
144874	10" x 14"	PL
144875	7" x 10"	AL
144876	10" x 14"	AL



144882	7" x 10"	FB
144878	10" x 14"	FB
144881	7" x 10"	SS
144879	10" x 14"	SS
144883	7" x 10"	PL
144877	10" x 14"	PL
144884	7" x 10"	AL
144880	10" x 14"	AL



144900	10" x 14"	FB
144899	10" x 14"	SS



144885	10" x 14"	FB
144887	7" x 10"	SS
144886	10" x 14"	SS
144888	7" x 10"	PL
144889	10" x 14"	PL
144890	7" x 10"	AL
144891	10" x 14"	AL



144913	7" x 10"	SS
144912	10" x 14"	SS
144914	7" x 10"	PL
144915	10" x 14"	PL
144916	7" x 10"	AL
144917	10" x 14"	AL

ANSI Signs (continued)



144926 7" x 10" SS
144927 10" x 14" SS
144924 7" x 10" PL
144925 10" x 14" PL
144928 7" x 10" AL
144929 10" x 14" AL



143681 10" x 14" FB
143679 10" x 14" SS
143682 7" x 10" PL
143660 10" x 14" PL
143680 7" x 10" AL
143655 10" x 14" AL



143656 7" x 10" SS
143657 10" x 14" SS
143659 7" x 10" PL
143658 7" x 10" AL



122813 7" x 10" FB
62866 10" x 14" FB
83954 3.5" x 5" SS
83839 7" x 10" SS
21866 7" x 10" PL
26591 10" x 14" PL
46579 7" x 10" AL
46819 10" x 14" AL



143667 10" x 14" FB
143669 3.5" x 5" SS
143662 7" x 10" SS
143661 10" x 14" SS
143668 7" x 10" PL
143666 10" x 14" PL
143665 7" x 10" AL
143664 10" x 14" AL



44981 10" x 7" FB
44982 14" x 10" FB
45117 10" x 7" SS
45118 14" x 10" SS
45050 14" x 10" PL



143676 7" x 10" SS



143683 7" x 10" SS
143684 10" x 14" SS
143686 7" x 10" PL
143685 10" x 14" PL
143688 7" x 10" AL
143687 10" x 14" AL



143689 7" x 10" SS
143690 10" x 14" SS
143692 7" x 10" PL
143691 10" x 14" PL
143694 7" x 10" AL
143693 10" x 14" AL



143671 10" x 7" SS
143670 14" x 10" SS
143673 10" x 7" PL
143672 14" x 10" PL
143675 10" x 7" AL
143674 14" x 10" AL



144612 7" x 10" SS
144608 7" x 10" PL
144611 7" x 10" AL



144609 10" x 14" FB
144613 10" x 14" SS
144607 10" x 14" PL
144610 10" x 14" AL



143872 10" x 14" FB
143874 7" x 10" SS
143875 10" x 14" SS
143873 7" x 10" PL
143871 10" x 14" PL
143876 7" x 10" AL
143877 10" x 14" AL



45015 10" x 7" FB
45151 10" x 7" SS
45084 14" x 10" PL
49003 10" x 7" AL
49004 14" x 10" AL



144936 3.5" x 5" SS
144937 7" x 10" SS
144938 10" x 14" SS
144939 7" x 10" PL
144940 10" x 14" PL
144941 7" x 10" AL
144942 10" x 14" AL



144946 7" x 10" SS
144943 10" x 14" SS
144947 7" x 10" PL
144944 10" x 14" PL
144948 7" x 10" AL
144945 10" x 14" AL



83896 3.5" x 5" SS
83675 7" x 10" SS
21723 7" x 10" PL
26543 10" x 14" PL
46641 7" x 10" AL



143946 7" x 10" SS
143947 10" x 14" SS
143945 7" x 10" PL
143944 10" x 14" PL
143948 7" x 10" AL
143949 10" x 14" AL



144961 7" x 10" SS
144967 10" x 14" SS
144963 7" x 10" PL
144964 10" x 14" PL
144965 7" x 10" AL
144966 10" x 14" AL



144971 10" x 14" FB
144969 3.5" x 5" SS
144968 7" x 10" SS
144973 7" x 10" PL
144972 10" x 14" PL
144974 7" x 10" AL



144976 7" x 10" SS
144975 10" x 14" SS
144979 7" x 10" PL
144980 10" x 14" PL
144978 7" x 10" AL
144977 10" x 14" AL



143754 7" x 10" SS
143753 10" x 14" SS
143755 7" x 10" PL
143756 10" x 14" PL
143757 7" x 10" AL
143758 10" x 14" AL



143730 7" x 10" FB
143738 7" x 10" SS
143739 10" x 14" SS
143737 7" x 10" PL
143733 10" x 14" PL
143735 7" x 10" AL
143734 10" x 14" AL



143736 10" x 14" FB



ANSI Signs

BradyID.com/s36

ANSI Signs (continued)



144468 7" x 10" SS
144469 10" x 14" SS
144470 7" x 10" PL
144471 10" x 14" PL
144472 7" x 10" AL
144467 10" x 14" AL



144308 7" x 10" SS
144307 10" x 14" SS
144187 7" x 10" PL
144306 10" x 14" PL
144310 7" x 10" AL
144311 10" x 14" AL



144197 7" x 10" SS
144199 10" x 14" SS
144198 7" x 10" PL
144196 10" x 14" PL
144200 7" x 10" AL
144201 10" x 14" AL



144204 10" x 14" FB
144202 7" x 10" SS
144205 10" x 14" SS
144206 7" x 10" PL
144203 10" x 14" PL
144207 7" x 10" AL
144208 10" x 14" AL

Sign Selection Guide

FB - Premium fiberglass (B-120)
SS - Self-sticking polyester (B-302)
PL - Plastic (B-401)
AL - Aluminum (B-555)
BGSS - BradyGlo™ self-stick polyester (B-324)
BGPL - BradyGlo™ plastic (B-347)

Material Comparison page 408
Sign Legend Index..... page 588



143709 3.5" x 5" SS
143713 7" x 10" SS
143707 10" x 14" SS
143711 7" x 10" PL
143712 10" x 14" PL
143710 7" x 10" AL
143708 10" x 14" AL



144209 7" x 10" SS
144210 10" x 14" SS
144211 7" x 10" PL
144212 10" x 14" PL
144213 7" x 10" AL
144214 10" x 14" AL



144220 7" x 10" SS
144217 10" x 14" SS
144218 7" x 10" PL
144219 7" x 10" PL
144216 10" x 14" PL



144473 7" x 5" B-811



62796 10" x 14" FB
83912 3.5" x 5" SS
83737 7" x 10" SS
122573 10" x 14" SS
21784 7" x 10" PL
26559 10" x 14" PL
46460 7" x 10" AL
46737 10" x 14" AL



143911 3.5" x 5" SS



144230 7" x 10" SS
144231 10" x 14" SS
144229 7" x 10" PL
144228 10" x 14" PL
144232 7" x 10" AL
144233 10" x 14" AL



144250 20" x 14" FB
144255 7" x 10" PL
144253 10" x 7" PL
144251 14" x 10" PL
144252 10" x 7" AL
144248 14" x 10" AL



144249 7" x 10" SS
144254 10" x 14" SS
144256 10" x 14" PL
144258 10" x 14" AL



144575 7" x 10" SS
144577 10" x 14" SS
144576 7" x 10" PL
144574 10" x 14" PL
144578 7" x 10" AL
144579 10" x 14" AL



144458 3.5" x 5" SS
144371 7" x 10" SS
144369 10" x 14" SS
144370 7" x 10" PL
144368 10" x 14" PL
144372 7" x 10" AL
144373 10" x 14" AL

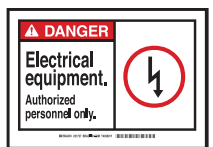

83900 3.5" x 5" SS
83679 7" x 10" SS
21727 7" x 10" PL
26547 10" x 14" PL
46645 7" x 10" AL
46689 10" x 14" AL



143878 10" x 14" FB
143879 7" x 10" SS
143880 10" x 14" SS
143881 7" x 10" PL
143882 10" x 14" PL
143883 7" x 10" AL
143884 10" x 14" AL



144297 7" x 17" FB



144304 10" x 14" FB
144309 7" x 10" PL



144362 7" x 10" SS
144363 10" x 14" SS
144364 7" x 10" PL
144365 10" x 14" PL
144366 7" x 10" AL
144367 10" x 14" AL



144474 5" x 3.5" B-811
144475 7" x 5" B-811
144477 7" x 10" SS
144478 10" x 14" SS
144476 7" x 10" PL
144479 10" x 14" PL
144480 7" x 10" AL
144481 10" x 14" AL



144982 10" x 14" FB
144983 7" x 10" SS
144981 10" x 14" SS
144986 7" x 10" PL
144987 10" x 14" PL
144985 7" x 10" AL
144984 10" x 14" AL



62797 10" x 14" FB
83913 3.5" x 5" SS
83738 7" x 10" SS
60572 10" x 14" SS
21785 7" x 10" PL
26560 10" x 14" PL
46461 7" x 10" AL
46738 10" x 14" AL



144635 10" x 14" FB
144621 3.5" x 5" SS
144630 10" x 14" SS
144619 10" x 14" PL
144616 10" x 14" AL



144615 7" x 10" SS
144622 10" x 14" SS
144620 7" x 10" PL
144634 10" x 14" PL
144617 7" x 10" AL
144632 10" x 14" AL



144374 7" x 10" SS
144375 10" x 14" SS
144376 7" x 10" PL
144377 10" x 14" PL
144378 7" x 10" AL
144379 10" x 14" AL



144116 7" x 10" SS
144117 10" x 14" SS
144118 7" x 10" PL
144114 10" x 14" PL
144119 7" x 10" AL
144120 10" x 14" AL



144116 7" x 10" SS
144117 10" x 14" SS
144118 7" x 10" PL
144114 10" x 14" PL
144119 7" x 10" AL
144120 10" x 14" AL

ANSI Signs (continued)



144136 7" x 10" SS
144137 10" x 14" SS
144134 7" x 10" PL
144135 10" x 14" PL
144132 7" x 10" AL
144133 10" x 14" AL



145015 10" x 14" FB
145019 7" x 10" SS
145014 10" x 14" SS
145017 7" x 10" PL
145016 10" x 14" PL
145018 7" x 10" AL
145000 10" x 14" AL



145020 10" x 14" SS
145025 7" x 10" PL
145024 10" x 14" PL
145022 7" x 10" AL



145026 7" x 10" SS
145031 10" x 14" AL
145032 7" x 10" SS
145034 10" x 14" SS
145035 7" x 10" PL
145036 7" x 10" AL
145037 10" x 14" AL



83731 7" x 10" SS
21778 7" x 10" PL
26553 10" x 14" PL
46454 7" x 10" AL
46731 10" x 14" AL



145053 7" x 10" SS
145041 10" x 14" SS
145042 7" x 10" PL
145040 10" x 14" PL
145046 7" x 10" AL
145038 10" x 14" AL



145045 10" x 14" SS



145055 10" x 14" FB
145050 10" x 14" SS
145056 7" x 10" PL
145054 7" x 10" AL
145051 10" x 14" AL



45019 10" x 7" FB
45020 14" x 10" FB
45155 10" x 7" SS
45156 14" x 10" SS
45087 10" x 7" PL
45088 14" x 10" PL
49008 14" x 10" AL



144997 7" x 10" SS
144998 10" x 14" SS
144999 7" x 10" PL
144996 10" x 14" PL
144995 7" x 10" AL
144994 10" x 14" AL

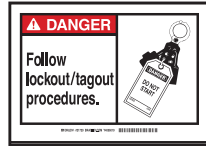

62436 7" x 10" FB
83902 3.5" x 5" SS
83681 7" x 10" SS
21729 7" x 10" PL
26549 10" x 14" PL
46647 7" x 10" AL
46691 10" x 14" AL



145058 7" x 10" SS
145060 10" x 14" SS
145061 7" x 10" PL
145057 10" x 14" PL
145059 7" x 10" AL
145062 10" x 14" AL



145063 10" x 14" FB
145064 7" x 10" SS
145065 10" x 14" SS
145066 7" x 10" PL
145067 10" x 14" PL
145068 7" x 10" AL
145069 10" x 14" AL



144153 10" x 14" FB
144157 7" x 10" SS
144154 10" x 14" SS
144156 7" x 10" PL
144152 10" x 14" PL
144155 7" x 10" AL
144151 10" x 14" AL



62794 10" x 14" FB
83910 3.5" x 5" SS
83735 7" x 10" SS
60574 10" x 14" SS
21782 7" x 10" PL
26557 10" x 14" PL
46458 7" x 10" AL
46735 10" x 14" AL



144636 7" x 10" AL



145080 7" x 10" SS
145081 10" x 14" SS
145078 7" x 10" PL
145112 10" x 14" PL
145077 7" x 10" AL
145076 10" x 14" AL



145084 7" x 10" FB
145086 10" x 14" FB
145085 7" x 10" PL
145088 10" x 14" PL
145087 7" x 10" AL
145083 10" x 14" AL



145091 7" x 10" SS
145108 10" x 14" SS
145093 7" x 10" PL
145095 7" x 10" AL
145096 10" x 14" AL



145107 7" x 10" SS
145103 7" x 10" PL
145104 10" x 14" AL



145111 7" x 10" SS
145110 10" x 14" SS
145109 7" x 10" PL
145114 7" x 10" AL
145113 10" x 14" AL



144639 10" x 14" FB
144642 7" x 10" SS
144643 10" x 14" SS
144638 7" x 10" PL
144637 10" x 14" PL
144641 7" x 10" AL
144640 10" x 14" AL



62756 10" x 14" FB
83901 3.5" x 5" SS
83680 7" x 10" SS
21728 7" x 10" PL
26548 10" x 14" PL
46646 7" x 10" AL
46690 10" x 14" AL



145136 7" x 10" SS
145137 10" x 14" SS
145138 7" x 10" PL



145132 7" x 10" SS
145133 10" x 14" SS
145129 7" x 10" PL
145139 10" x 14" PL
145131 7" x 10" AL
145130 10" x 14" AL

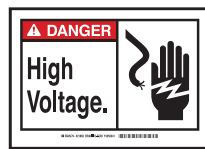

95772 7" x 10" FB
62868 10" x 14" FB
83956 3.5" x 5" SS
83841 7" x 10" SS
21868 7" x 10" PL
26593 10" x 14" PL
46581 7" x 10" AL
46821 10" x 14" AL



45011 10" x 7" FB
45012 14" x 10" FB
45147 10" x 7" SS
45148 14" x 10" SS
45080 14" x 10" PL
48999 10" x 7" AL



144406 14" x 20" FB



144412 7" x 10" SS
144409 10" x 14" SS
144411 7" x 10" PL
144408 10" x 14" PL
144410 7" x 10" AL
144407 10" x 14" AL

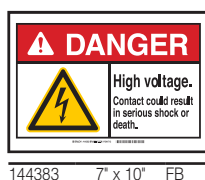

144383 7" x 10" FB
144384 10" x 14" FB
144386 2.25" x 4.5" SS
144380 3.5" x 5" SS
144381 7" x 10" SS
144382 10" x 14" SS
144389 7" x 10" BGSS
144388 7" x 10" PL
144385 10" x 14" PL
144387 7" x 10" AL

ANSI Signs

BradyID.com/s36

ANSI Signs (continued)



144415 7" x 17" FB



144414 10" x 14" FB
144413 7" x 10" SS
144416 10" x 14" SS
144417 7" x 10" PL
144418 10" x 14" PL
144419 7" x 10" AL
144420 10" x 14" AL



44992 14" x 10" FB
45127 10" x 7" SS
45059 10" x 7" PL
45060 14" x 10" PL
48979 10" x 7" AL
48980 14" x 10" AL



144651 7" x 10" FB
144645 10" x 14" FB
144659 14" x 20" FB
144648 3.5" x 5" SS
144660 7" x 10" SS
144661 10" x 14" SS
144658 7" x 10" PL
144657 10" x 14" PL
144652 7" x 10" AL
144644 10" x 14" AL

Sign Selection Guide

- FB - Premium fiberglass (B-120)
- SS - Self-sticking polyester (B-302)
- PL - Plastic (B-401)
- AL - Aluminum (B-555)
- BGSS - BradyGlo™ self-stick polyester (B-324)
- BGPL - BradyGlo™ plastic (B-347)

Material Comparison page 408
Sign Legend Index..... page 588



144459 3.5" x 5" SS

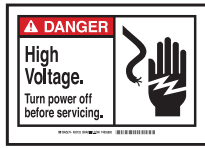

62791 10" x 14" FB
83907 3.5" x 5" SS
83732 7" x 10" SS
46732 10" x 14" AL

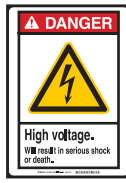

144398 10" x 7" FB
144397 10" x 7" SS
144401 14" x 10" SS
144399 10" x 7" PL
144402 14" x 10" PL
144400 10" x 7" AL
144403 14" x 10" AL



144396 10" x 14" BGSS
144405 10" x 14" AL



144460 3.5" x 5" SS
144461 7" x 10" SS
144462 10" x 14" SS
144463 7" x 10" PL
144464 10" x 14" PL
144465 7" x 10" AL
144466 10" x 14" AL



144423 7" x 10" SS
144426 10" x 14" SS
144421 7" x 10" PL
144424 10" x 14" PL
144425 7" x 10" AL
144422 10" x 14" AL



62753 10" x 14" FB
83898 3.5" x 5" SS
83677 7" x 10" SS
21725 7" x 10" PL
26545 10" x 14" PL
46643 7" x 10" AL
46687 10" x 14" AL



143841 7" x 10" SS
143842 10" x 14" SS
143843 7" x 10" PL
143844 10" x 14" PL
143840 7" x 10" AL
143845 10" x 14" AL



143852 7" x 17" FB



143853 7" x 10" SS
143854 10" x 14" SS
143855 7" x 10" PL
143856 10" x 14" PL
143857 7" x 10" AL
143858 10" x 14" AL



143836 10" x 14" FB
143832 3.5" x 5" SS
143810 10" x 14" SS
143838 10" x 14" AL



143815 10" x 14" AL



145140 7" x 10" SS
145141 10" x 14" SS
145144 7" x 10" PL
145145 10" x 14" PL
145143 7" x 10" AL
145142 10" x 14" AL



145147 10" x 14" FB
145151 7" x 10" SS
145152 10" x 14" SS
145150 7" x 10" PL
145148 10" x 14" PL
145149 7" x 10" AL
145146 10" x 14" AL



145153 7" x 17" FB



145158 7" x 10" SS
145159 10" x 14" SS
145156 7" x 10" PL
145154 10" x 14" PL
145157 7" x 10" AL
145155 10" x 14" AL



144662 7" x 10" FB
144663 7" x 10" SS
144664 10" x 14" SS
144665 7" x 10" PL
144666 10" x 14" PL
144667 7" x 10" AL
144668 10" x 14" AL



144671 10" x 14" FB
144675 7" x 10" SS
144672 7" x 10" PL
144670 10" x 14" PL
144674 7" x 10" AL
144669 10" x 14" AL

Safety Signs

ANSI Signs (continued)



44993 10" x 7" FB
44994 14" x 10" FB
45129 10" x 7" SS



143973 7" x 10" SS
143974 10" x 14" SS
143971 7" x 10" PL
143972 10" x 14" PL
143970 7" x 10" AL
143969 10" x 14" AL



62530 7" x 10" FB
62792 10" x 14" FB
83908 3.5" x 5" SS
83733 7" x 10" SS
21780 7" x 10" PL
26555 10" x 14" PL
46733 10" x 14" AL



144544 7" x 10" SS
144545 10" x 14" SS
144546 7" x 10" PL
144547 10" x 14" PL
144548 7" x 10" AL
144549 10" x 14" AL



144552 7" x 10" SS
144555 10" x 14" SS
144550 7" x 10" PL
144553 10" x 14" PL
144551 7" x 10" AL
144554 10" x 14" AL



145171 7" x 10" SS
145172 10" x 14" SS
145168 7" x 10" PL
145167 10" x 14" PL
145170 7" x 10" AL
145169 10" x 14" AL



144439 10" x 14" FB
144440 7" x 10" SS
144441 10" x 14" SS
144442 7" x 10" PL
144443 10" x 14" PL
144444 7" x 10" AL
144445 10" x 14" AL



144482 7" x 10" SS
144483 10" x 14" SS
144484 7" x 10" PL
144485 10" x 14" PL
144486 7" x 10" AL
144487 10" x 14" AL



144490 7" x 10" SS
144491 10" x 14" SS
144492 7" x 10" PL
144493 10" x 14" PL
144488 7" x 10" AL
144489 10" x 14" AL



143975 10" x 14" AL



143976 10" x 14" FB
143980 10" x 14" SS
143979 7" x 10" B-302
143981 7" x 10" PL
143977 10" x 14" PL
143982 7" x 10" AL
143978 10" x 14" AL



143984 7" x 10" SS
143985 10" x 14" SS
143986 7" x 10" PL
143983 10" x 14" PL
143987 7" x 10" AL
143988 10" x 14" AL



144007 7" x 10" SS
144008 10" x 14" SS
144006 7" x 10" PL
144004 10" x 14" PL
144003 7" x 10" AL
144005 10" x 14" AL



145174 14" x 20" FB
145178 7" x 10" SS
145179 10" x 14" SS
145177 7" x 10" PL
145176 10" x 14" PL
145175 7" x 10" AL
145173 10" x 14" AL



144011 10" x 14" FB
144010 20" x 14" FB
144015 7" x 10" SS
144016 10" x 14" SS
144013 7" x 10" PL
144009 10" x 14" PL
144014 7" x 10" AL
144012 10" x 14" AL



144556 7" x 10" SS
144558 10" x 14" SS
144557 7" x 10" PL
144559 10" x 14" PL
144560 7" x 10" AL
144561 10" x 14" AL



144017 7" x 10" SS
144020 10" x 14" SS
144019 7" x 10" PL
144022 10" x 14" PL
144018 7" x 10" AL
144021 10" x 14" AL



145184 7" x 10" SS
145185 10" x 14" SS
145183 7" x 10" PL
145182 10" x 14" PL
145181 7" x 10" AL



145188 7" x 10" SS
145189 10" x 14" SS
145187 7" x 10" PL
145186 10" x 14" PL
145191 7" x 10" AL
145190 10" x 14" AL



145194 7" x 10" SS
145195 10" x 14" SS
145192 7" x 10" PL
145193 10" x 14" PL
145197 7" x 10" AL
145196 10" x 14" AL



144516 7" x 10" SS
144517 10" x 14" SS
144518 7" x 10" PL
144519 10" x 14" PL
144515 7" x 10" AL
144514 10" x 14" AL



143762 10" x 14" FB
143763 7" x 10" SS
143760 10" x 14" SS
143761 10" x 14" PL
143764 7" x 10" AL
143759 10" x 14" AL



62827 10" x 14" FB
83943 3.5" x 5" SS
83768 7" x 10" SS
21815 7" x 10" PL
26590 10" x 14" PL
46491 7" x 10" AL
46768 10" x 14" AL



143772 7" x 17" FB



143774 10" x 14" FB
143776 14" x 20" FB
143777 7" x 10" SS
143773 10" x 14" SS
143780 7" x 10" PL
143778 10" x 14" PL
143779 7" x 10" AL
143775 10" x 14" AL



143783 10" x 14" FB
143785 3.5" x 5" SS
143784 7" x 10" SS
143781 10" x 14" SS
143787 7" x 10" PL
143782 10" x 14" PL
143786 7" x 10" AL
143788 10" x 14" AL



45123 10" x 7" SS
45124 14" x 10" SS
45055 10" x 7" PL
45056 14" x 10" PL
48975 10" x 7" AL
48976 14" x 10" AL

Design custom signs online
BradyID.com/customsigns

ANSI Signs

BradyID.com/s36

ANSI Signs (continued)



143791	7" x 10"	SS
143792	10" x 14"	SS
143793	7" x 10"	PL
143794	10" x 14"	PL
143790	7" x 10"	AL
143789	10" x 14"	AL



143795	7" x 10"	SS
143797	10" x 14"	SS
143796	7" x 10"	PL
143798	10" x 14"	PL
143799	7" x 10"	AL
143800	10" x 14"	AL



141913	10" x 7"	FB
141908	14" x 10"	FB
141914	10" x 7"	SS
141909	14" x 10"	SS
141917	10" x 7"	PL
141912	14" x 10"	PL
141915	10" x 7"	AL
141910	14" x 10"	AL
141916	10" x 7"	B-946
141911	14" x 10"	B-946



144686	7" x 10"	SS
144687	10" x 14"	SS
144684	7" x 10"	PL
144685	10" x 14"	PL
144682	7" x 10"	AL
144683	10" x 14"	AL

Sign Selection Guide

FB - Premium fiberglass (B-120)
 SS - Self-sticking polyester (B-302)
 PL - Plastic (B-401)
 AL - Aluminum (B-555)
 BGSS - BradyGlo™ self-stick polyester (B-324)
 BGPL - BradyGlo™ plastic (B-347)

Material Comparison page 408
 Sign Legend Index..... page 588



144692	10" x 7"	SS
144693	14" x 10"	SS
144690	10" x 7"	PL
144691	14" x 10"	PL
144688	10" x 7"	AL
144689	14" x 10"	AL



143695	7" x 10"	SS
143696	10" x 14"	SS
143698	7" x 10"	PL
143697	10" x 14"	PL
143700	7" x 10"	AL
143699	10" x 14"	AL



145205	7" x 17"	FB
--------	----------	----



145206	7" x 10"	SS
145207	10" x 14"	SS
145208	7" x 10"	PL
145209	10" x 14"	PL
145210	7" x 10"	AL
145211	10" x 14"	AL



144730	7" x 10"	FB
144735	7" x 10"	SS
144736	10" x 14"	SS
144732	7" x 10"	PL
144731	10" x 14"	PL
144734	7" x 10"	AL
144733	10" x 14"	AL



144738	10" x 14"	FB
144740	7" x 10"	SS
144741	10" x 14"	SS
144742	7" x 10"	PL
144743	10" x 14"	PL
144739	7" x 10"	AL
144737	10" x 14"	AL



144746	7" x 10"	SS
144747	10" x 14"	SS
144745	7" x 10"	PL
144744	10" x 14"	PL
144748	7" x 10"	AL
144749	10" x 14"	AL



144456	7" x 10"	SS
144457	10" x 14"	SS
144455	7" x 10"	PL
144453	10" x 14"	PL
144454	7" x 10"	AL
144452	10" x 14"	AL



144568	7" x 10"	SS
144569	10" x 14"	SS
144570	7" x 10"	PL
144571	10" x 14"	PL
144572	7" x 10"	AL
144573	10" x 14"	AL



144034	7" x 10"	SS
144035	10" x 14"	SS
144032	7" x 10"	PL
144031	10" x 14"	PL
144033	7" x 10"	AL
144030	10" x 14"	AL



122829	7" x 10"	FB
122715	10" x 14"	FB
83911	3.5" x 5"	SS
83736	7" x 10"	SS
122574	10" x 14"	SS
21783	7" x 10"	PL
26558	10" x 14"	PL
46459	7" x 10"	AL
46736	10" x 14"	AL



143913	3.5" x 5"	SS
143914	7" x 10"	SS
143916	7" x 10"	PL
143918	7" x 10"	AL



145212	10" x 14"	FB
145213	7" x 10"	SS
145214	10" x 14"	SS
145215	7" x 10"	PL
145216	10" x 14"	PL
145217	7" x 10"	AL
145218	10" x 14"	AL



145229	7" x 10"	SS
145230	10" x 14"	SS
145227	7" x 10"	PL
145228	10" x 14"	PL
145231	7" x 10"	AL
145225	10" x 14"	AL



145233	10" x 14"	FB
145234	7" x 10"	SS



144698	7" x 10"	SS
144699	10" x 14"	SS
144696	7" x 10"	PL
144697	10" x 14"	PL
144695	7" x 10"	AL
144694	10" x 14"	AL



144037	7" x 10"	FB
144036	7" x 10"	SS
144038	10" x 14"	SS
144042	7" x 10"	PL
144041	10" x 14"	PL
144039	7" x 10"	AL
144040	10" x 14"	AL



62433	7" x 10"	FB
62754	10" x 14"	FB
83899	3.5" x 5"	SS
83678	7" x 10"	SS
21726	7" x 10"	PL
26546	10" x 14"	PL
46644	7" x 10"	AL
46688	10" x 14"	AL

ANSI Signs (continued)



144049 7" x 17" FB



144043 7" x 10" SS
144044 10" x 14" SS
144045 7" x 10" PL
144046 10" x 14" PL
144047 7" x 10" AL
144048 10" x 14" AL



144051 7" x 10" SS
144052 10" x 14" SS
144053 7" x 10" PL
144050 10" x 14" PL
144054 7" x 10" AL
144055 10" x 14" AL



143927 7" x 10" SS
143929 10" x 14" SS
143926 7" x 10" PL
143928 10" x 14" PL
143930 7" x 10" AL
143931 10" x 14" AL



144057 7" x 10" SS
144056 10" x 14" SS
144058 7" x 10" PL
144059 10" x 14" PL
144060 7" x 10" AL
144061 10" x 14" AL



145250 7" x 10" SS
145251 10" x 14" SS
145254 7" x 10" PL
145255 10" x 14" PL
145253 7" x 10" AL
145252 10" x 14" AL



145257 7" x 10" SS
145256 10" x 14" SS
145260 7" x 10" PL
145261 10" x 14" PL
145259 7" x 10" AL
145258 10" x 14" AL



144700 7" x 10" SS
144701 10" x 14" SS
144702 7" x 10" PL
144703 10" x 14" PL
144705 10" x 14" AL



144062 7" x 10" SS
144063 10" x 14" SS
144064 7" x 10" PL
144065 10" x 14" PL
144066 7" x 10" AL
144067 10" x 14" AL



44983 10" x 7" FB
44984 14" x 10" FB
45119 10" x 7" SS
45052 14" x 10" PL
48972 14" x 10" AL



144074 7" x 10" FB
144068 10" x 14" FB
144071 3.5" x 5" SS
144070 10" x 14" SS
144076 7" x 10" PL
144073 10" x 14" PL
144075 7" x 10" AL
144069 10" x 14" AL



144077 7" x 10" SS
144078 10" x 14" SS
144079 7" x 10" PL
144080 10" x 14" PL
144081 7" x 10" AL
144082 10" x 14" AL



144581 7" x 10" PL
144580 7" x 10" AL



144710 7" x 10" SS
144711 10" x 14" SS
144707 7" x 10" PL
144706 10" x 14" PL
144708 7" x 10" AL
144709 10" x 14" AL



144083 7" x 10" SS
144084 10" x 14" SS
144085 7" x 10" PL
144086 10" x 14" PL
144087 7" x 10" AL
144088 10" x 14" AL



144584 7" x 10" SS
144585 10" x 14" SS
144586 7" x 10" PL
144587 10" x 14" PL
144583 7" x 10" AL
144582 10" x 14" AL



144106 7" x 10" SS
144107 10" x 14" SS
144105 7" x 10" PL
144103 10" x 14" PL
144104 7" x 10" AL
144102 10" x 14" AL



145269 7" x 10" SS
145268 10" x 14" SS
145272 7" x 10" PL
145273 10" x 14" PL
145271 7" x 10" AL
145270 10" x 14" AL



145283 7" x 10" SS
145282 10" x 14" SS
145281 7" x 10" PL
145280 10" x 14" PL
145285 7" x 10" AL
145284 10" x 14" AL



45021 10" x 7" FB
45022 14" x 10" FB
45157 10" x 7" SS
45158 14" x 10" SS
45089 10" x 7" PL
45090 14" x 10" PL
49009 10" x 7" AL
49010 14" x 10" AL



120645 7" x 10" SS
119752 10" x 14" SS
119990 5" x 7" SSV
119768 10" x 14" SSV
120658 7" x 10" BGPL
119764 10" x 14" BGPL
119982 5" x 7" SS
119986 5" x 7" PL
120649 7" x 10" PL
119756 10" x 14" PL
120653 7" x 10" AL
119760 10" x 14" AL



132218 7" x 10" FB
132219 10" x 14" FB
132220 7" x 10" SS
132221 10" x 14" SS
132214 7" x 10" PL
132215 10" x 14" PL
132216 7" x 10" AL
132217 10" x 14" AL



62557 7" x 10" FB
122753 10" x 14" FB
83935 3.5" x 5" SS
83760 7" x 10" SS
122612 10" x 14" SS
21807 7" x 10" PL
26582 10" x 14" PL
46483 7" x 10" AL
46760 10" x 14" AL



62818 10" x 14" FB
83934 3.5" x 5" SS
83759 7" x 10" SS
21806 7" x 10" PL
46482 7" x 10" AL
46759 10" x 14" AL

ANSI Signs

BradyID.com/s36

ANSI Signs (continued)



83936	3.5' x 5'	SS
83761	7' x 10'	SS
21808	7' x 10'	PL
26583	10' x 14'	PL
46484	7' x 10'	AL
46761	10' x 14'	AL



62555	7' x 10'	FB
62817	10' x 14'	FB
83933	3.5' x 5'	SS
83758	7' x 10'	SS
21805	7' x 10'	PL
26580	10' x 14'	PL
46481	7' x 10'	AL
46758	10' x 14'	AL



62560	7' x 10'	FB
62822	10' x 14'	FB
83938	3.5' x 5'	SS
83763	7' x 10'	SS
21810	7' x 10'	PL
26585	10' x 14'	PL
46486	7' x 10'	AL
46763	10' x 14'	AL



44979	10' x 7'	FB
44980	14' x 10'	FB
45115	10' x 7'	SS
45116	14' x 10'	SS
45047	10' x 7'	PL
45048	14' x 10'	PL
48967	10' x 7'	AL
48968	14' x 10'	AL

Sign Selection Guide

- FB - Premium fiberglass (B-120)
- SS - Self-sticking polyester (B-302)
- PL - Plastic (B-401)
- AL - Aluminum (B-555)
- BGSS - BradyGlo™ self-stick polyester (B-324)
- BGPL - BradyGlo™ plastic (B-347)

Material Comparison page 408
Sign Legend Index..... page 588



83874	3.5' x 5'	SS
21700	7' x 10'	PL
26521	10' x 14'	PL
46661	10' x 14'	AL



62561	7' x 10'	FB
83939	3.5' x 5'	SS
83764	7' x 10'	SS
26586	10' x 14'	PL
46764	10' x 14'	AL



83658	7' x 10'	SS
21707	7' x 10'	PL
26528	10' x 14'	PL



83877	3.5' x 5'	SS
83654	7' x 10'	SS
21703	7' x 10'	PL
26524	10' x 14'	PL
46620	7' x 10'	AL
46664	10' x 14'	AL



45173	10' x 7'	SS
45105	10' x 7'	PL
45106	14' x 10'	PL
49026	14' x 10'	AL



45035	10' x 7'	FB
45171	10' x 7'	SS
45172	14' x 10'	SS
45103	10' x 7'	PL
45104	14' x 10'	PL
49024	14' x 10'	AL



45141	10' x 7'	SS
45073	10' x 7'	PL
45074	14' x 10'	PL



44985	10' x 7'	FB
45121	10' x 7'	SS
45122	14' x 10'	SS
45053	10' x 7'	PL
45054	14' x 10'	PL
48974	14' x 10'	AL



45001	10' x 7'	FB
45138	14' x 10'	SS
45069	10' x 7'	PL
48989	10' x 7'	AL
48990	14' x 10'	AL



45113	10' x 7'	SS
45045	10' x 7'	PL
48966	14' x 10'	AL



62810	10' x 14'	FB
83751	7' x 10'	SS
21798	7' x 10'	PL
26573	10' x 14'	PL
46474	7' x 10'	AL
46751	10' x 14'	AL



44999	10' x 7'	FB
45000	14' x 10'	FB
45136	14' x 10'	SS
45067	10' x 7'	PL
45068	14' x 10'	PL
48987	10' x 7'	AL
48988	14' x 10'	AL



126422	10' x 7'	SS
126425	14' x 10'	SS
126421	10' x 7'	PL
126424	14' x 10'	PL
126420	10' x 7'	AL
126423	14' x 10'	AL



132235	7' x 10'	FB
132236	10' x 14'	FB
132237	7' x 10'	SS
132238	10' x 14'	SS
132231	7' x 10'	PL
132232	10' x 14'	PL
132233	7' x 10'	AL
132234	10' x 14'	AL



132244	7' x 10'	FB
132245	10' x 14'	FB
132246	7' x 10'	SS
132247	10' x 14'	SS
132240	7' x 10'	PL
132241	10' x 14'	PL
132242	7' x 10'	AL
132243	10' x 14'	AL



45179	10' x 7'	SS
45180	10' x 7'	SS
45111	10' x 7'	PL
45112	14' x 10'	PL
49032	14' x 10'	AL



144605	7' x 10'	SS
144603	7' x 10'	PL
144602	7' x 10'	AL



45017	10' x 7'	FB
45018	14' x 10'	FB
45153	10' x 7'	SS
45154	14' x 10'	SS
45085	10' x 7'	PL
45086	14' x 10'	PL
49005	10' x 7'	AL
49006	10' x 14'	AL

Safety Signs

ANSI Signs (continued)



144606	10" x 14"	SS
144604	10" x 14"	PL
144595	10" x 14"	AL



126506	7" x 10"	SS
126509	10" x 14"	SS
126505	7" x 10"	PL
126508	10" x 14"	PL
126504	7" x 10"	AL
126507	10" x 14"	AL



143728	7" x 10"	SS
143729	10" x 14"	SS
143725	7" x 10"	PL
143727	10" x 14"	PL
143724	7" x 10"	AL
143726	10" x 14"	AL



143963	7" x 10"	SS
143964	10" x 14"	SS
143965	7" x 10"	PL
143966	10" x 14"	PL
143967	7" x 10"	AL
143968	10" x 14"	AL



144623	7" x 10"	SS
144624	10" x 14"	SS
144625	7" x 10"	PL
144626	10" x 14"	PL
144627	7" x 10"	AL
144628	10" x 14"	AL



145099	7" x 10"	SS
145100	10" x 14"	SS
145101	7" x 10"	PL
145102	10" x 14"	PL
145097	7" x 10"	AL
145098	10" x 14"	AL



144390	7" x 10"	SS
144393	10" x 14"	SS
144391	7" x 10"	PL
144394	10" x 14"	PL
144392	7" x 10"	AL
144395	10" x 14"	AL



143824	7" x 10"	SS
143825	10" x 14"	SS
143826	7" x 10"	PL
143827	10" x 14"	PL
143823	7" x 10"	AL
143828	10" x 14"	AL

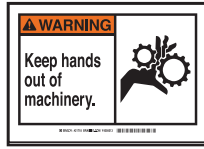

62423	7" x 10"	FB
62743	10" x 14"	FB
83892	3.5" x 5"	SS
83669	7" x 10"	SS
21718	7" x 10"	PL
26539	10" x 14"	PL
46679	10" x 14"	AL
46635	7" x 10"	AL



145162	10" x 14"	FB
145164	7" x 10"	SS
145161	10" x 14"	SS
145163	7" x 10"	PL
145160	10" x 14"	PL
145166	7" x 10"	AL
145165	10" x 14"	AL



45028	14" x 10"	FB
45163	10" x 7"	SS
45164	10" x 7"	SS
45095	10" x 7"	PL
45096	14" x 10"	PL
49015	10" x 7"	AL
49016	14" x 10"	AL



144680	7" x 10"	SS
144681	10" x 14"	SS
144678	7" x 10"	PL
144677	10" x 14"	PL
144679	7" x 10"	AL
144676	10" x 14"	AL



145248	7" x 10"	SS
145249	10" x 14"	SS
145246	7" x 10"	PL
145247	10" x 14"	PL
145245	7" x 10"	AL
145244	10" x 14"	AL



126494	10" x 7"	SS
126497	14" x 10"	SS
126493	10" x 7"	PL
126496	14" x 10"	PL
126492	10" x 7"	AL
126495	14" x 10"	AL



129026	10" x 7"	SS
129029	14" x 10"	SS
129025	10" x 7"	PL
129028	14" x 10"	PL
129024	10" x 7"	AL
129027	14" x 10"	AL



90175	14" x 10"	BGSS
90706	10" x 7"	BGPL



90707	10" x 7"	BGPL
-------	----------	------



45009	10" x 7"	FB
45145	10" x 7"	SS
45146	14" x 10"	SS
45077	10" x 7"	PL
45078	14" x 10"	PL
48998	14" x 10"	AL



83941	3.5" x 5"	SS
83766	7" x 10"	SS
21813	7" x 10"	PL
26588	10" x 14"	PL
46489	7" x 10"	AL
46766	10" x 14"	AL



83942	3.5" x 5"	SS
83767	7" x 10"	SS
21814	7" x 10"	PL
26589	10" x 14"	PL
46767	10" x 14"	AL



45013	10" x 7"	FB
45150	14" x 10"	SS
45081	10" x 7"	PL
45082	14" x 10"	PL
49001	10" x 7"	AL



44995	10" x 7"	FB
44996	14" x 10"	FB
45131	10" x 7"	SS
45132	14" x 10"	SS
45063	10" x 7"	PL
45064	14" x 10"	PL
48983	10" x 7"	AL
48984	14" x 10"	AL



45133	10" x 7"	SS
45065	10" x 7"	PL

Bilingual and Spanish-Only Signs

BradyID.com/s36

Bilingual and Spanish-Only Signs

Brady has a full line of Bilingual and Spanish signs that communicate safety and facility information to your Spanish-speaking employees and visitors. Brady Spanish signs provide your facility with the appropriate Spanish safety message such as "precaucion," "peligro," "seguridad primero," "aviso" and "advertencia."

Sign Selection Guide

- FB** - Premium fiberglass (B-120)
- SS** - Self-sticking polyester (B-302)
- PL** - Plastic (B-401)
- AL** - Aluminum (B-555)
- BGSS** - BradyGlo™ self-sticking (B-324)
- BGPL** - BradyGlo plastic (B-347)

Material Comparison page 408
Sign Legend Index..... page 588



124051	10" x 7"	SS
124054	14" x 10"	SS
124050	10" x 7"	PL
124053	14" x 10"	PL
124049	10" x 7"	AL
124052	14" x 10"	AL



125393	10" x 7"	SS
125396	14" x 10"	SS
90514	14" x 10"	BGSS
125392	10" x 7"	PL
125395	14" x 10"	PL
125391	10" x 7"	AL
125394	14" x 10"	AL



125429	7" x 10"	SS
125432	10" x 14"	SS
125428	7" x 10"	PL
125431	10" x 14"	PL
125427	7" x 10"	AL
125430	10" x 14"	AL



125351	7" x 10"	SS
125354	10" x 14"	SS
125350	7" x 10"	PL
125353	10" x 14"	PL
125349	7" x 10"	AL
125352	10" x 14"	AL



125477	10" x 7"	SS
125480	14" x 10"	SS
125476	10" x 7"	PL
125479	14" x 10"	PL
125475	10" x 7"	AL
125478	14" x 10"	AL



125333	7" x 10"	SS
125336	10" x 14"	SS
125332	7" x 10"	PL
125335	10" x 14"	PL
125331	7" x 10"	AL
125334	10" x 14"	AL



125345	10" x 7"	SS
125348	14" x 10"	SS
125344	10" x 7"	PL
125347	14" x 10"	PL
125343	10" x 7"	AL
125346	14" x 10"	AL



39850	7" x 10"	FB
38964	7" x 10"	PL
38984	10" x 14"	PL
38474	10" x 14"	AL



123997	10" x 7"	SS
124000	14" x 10"	SS
123996	10" x 7"	PL
123999	14" x 10"	PL
123995	10" x 7"	AL
123998	14" x 10"	AL



122807	7" x 10"	FB
122783	14" x 10"	FB
122645	7" x 10"	SS
90809	14" x 10"	SS
122512	7" x 10"	PL
38942	14" x 10"	PL
122401	7" x 10"	AL
38430	14" x 10"	AL



125339	10" x 7"	SS
125342	14" x 10"	SS
125338	10" x 7"	PL
125341	14" x 10"	PL
125337	10" x 7"	AL
125340	14" x 10"	AL



124913	7" x 10"	SS
124916	10" x 14"	SS
124912	7" x 10"	PL
124915	10" x 14"	PL
124911	7" x 10"	AL
124914	10" x 14"	AL



39738	20" x 14"	FB
90816	14" x 10"	SS
38846	14" x 10"	PL
38345	14" x 10"	AL



124057	10" x 7"	SS
124060	14" x 10"	SS
124056	10" x 7"	PL
124059	14" x 10"	PL
124055	10" x 7"	AL
124058	14" x 10"	AL



125357	10" x 7"	SS
125360	14" x 10"	SS
125356	10" x 7"	PL
125359	14" x 10"	PL
125355	10" x 7"	AL
125358	14" x 10"	AL



125465	10" x 7"	SS
125468	14" x 10"	SS
125464	10" x 7"	PL
125467	14" x 10"	PL
125463	10" x 7"	AL
125466	14" x 10"	AL



125363	10" x 7"	SS
125366	14" x 10"	SS
125362	10" x 7"	PL
125365	14" x 10"	PL
125361	10" x 7"	AL
125364	14" x 10"	AL



125459	10" x 7"	SS
125462	14" x 10"	SS
125458	10" x 7"	PL
125461	14" x 10"	PL
125457	10" x 7"	AL
125460	14" x 10"	AL



125405	10" x 7"	SS
125408	14" x 10"	SS
125404	10" x 7"	PL
125407	14" x 10"	PL
125403	10" x 7"	AL
125406	14" x 10"	AL



125399	10" x 7"	SS
125402	14" x 10"	SS
125398	10" x 7"	PL
125401	14" x 10"	PL
125397	10" x 7"	AL
125400	14" x 10"	AL



125369	10" x 7"	SS
125372	14" x 10"	SS
125368	10" x 7"	PL
125371	14" x 10"	PL
125367	10" x 7"	AL
125370	14" x 10"	AL



125417	10" x 7"	SS
125420	14" x 10"	SS
125416	10" x 7"	PL
125419	14" x 10"	PL
125415	10" x 7"	AL
125418	14" x 10"	AL

Bilingual and Spanish-Only Signs

BradyID.com/s36

Bilingual and Spanish-Only Signs (continued)



125375	10" x 7"	SS
125378	14" x 10"	SS
125374	10" x 7"	PL
125377	14" x 10"	PL
125373	10" x 7"	AL
125376	14" x 10"	AL



125327	7" x 10"	SS
125330	10" x 14"	SS
125326	7" x 10"	PL
125329	10" x 14"	PL
125325	7" x 10"	AL
125328	10" x 14"	AL



124919	7" x 10"	SS
124922	10" x 14"	SS
124918	7" x 10"	PL
124921	10" x 14"	PL
124917	7" x 10"	AL
124920	10" x 14"	AL



125411	10" x 7"	SS
125414	14" x 10"	SS
125410	10" x 7"	PL
125413	14" x 10"	PL
125409	10" x 7"	AL
125412	14" x 10"	AL



125453	10" x 7"	SS
125456	14" x 10"	SS
125452	10" x 7"	PL
125455	14" x 10"	PL
125451	10" x 7"	AL
125454	14" x 10"	AL



125387	7" x 10"	SS
125390	10" x 14"	SS
125386	7" x 10"	PL
125389	10" x 14"	PL
125385	7" x 10"	AL
125388	10" x 14"	AL



125381	7" x 10"	SS
125384	10" x 14"	SS
125380	7" x 10"	PL
125383	10" x 14"	PL
125379	7" x 10"	AL
125382	10" x 14"	AL



125471	10" x 7"	SS
125474	14" x 10"	SS
125470	10" x 7"	PL
125473	14" x 10"	PL
125469	10" x 7"	AL
125472	14" x 10"	AL



124931	7" x 10"	SS
124934	10" x 14"	SS
124930	7" x 10"	PL
124933	10" x 14"	PL
124929	7" x 10"	AL
124932	10" x 14"	AL



125483	10" x 7"	SS
125486	14" x 10"	SS
125482	10" x 7"	PL
125485	14" x 10"	PL
125481	10" x 7"	AL
125484	14" x 10"	AL



125447	10" x 7"	SS
125450	14" x 10"	SS
125446	10" x 7"	PL
125449	14" x 10"	PL
125445	10" x 7"	AL
125448	14" x 10"	AL



39965	20" x 14"	FB
90817	14" x 10"	SS
39085	14" x 10"	PL
38585	14" x 10"	AL



39149	10" x 14"	PL
37847	10" x 14"	AL



125321	7" x 10"	SS
125324	10" x 14"	SS
125320	7" x 10"	PL
125323	10" x 14"	PL
125319	7" x 10"	AL
125322	10" x 14"	AL



124925	7" x 10"	SS
124928	10" x 14"	SS
124924	7" x 10"	PL
124927	10" x 14"	PL
124923	7" x 10"	AL
124926	10" x 14"	AL



125441	10" x 7"	SS
125444	14" x 10"	SS
125440	10" x 7"	PL
125443	14" x 10"	PL
125439	10" x 7"	AL
125442	14" x 10"	AL



122805	7" x 10"	FB
122781	14" x 10"	FB
122643	7" x 10"	SS
90818	14" x 10"	SS
122510	7" x 10"	PL
39086	14" x 10"	PL
122399	7" x 10"	AL
38586	14" x 10"	AL



39173	10" x 14"	FB
39123	7" x 10"	PL
39150	10" x 14"	PL
37848	10" x 14"	AL



39991	7" x 10"	FB
39171	10" x 14"	FB
37803	7" x 10"	SS
39121	7" x 10"	PL
39148	10" x 14"	PL



122806	7" x 10"	FB
122782	14" x 10"	FB
39964	20" x 14"	FB
122644	7" x 10"	SS
90799	14" x 10"	SS
122511	7" x 10"	PL
39084	14" x 10"	PL
122400	7" x 10"	AL
122391	14" x 10"	AL



125435	10" x 7"	SS
125438	14" x 10"	SS
125434	10" x 7"	PL
125437	14" x 10"	PL
125433	10" x 7"	AL
125436	14" x 10"	AL

Bilingual and Spanish-Only Signs

BradyID.com/s36

Bilingual and Spanish-Only Signs (continued)



90792	14" x 10"	SS
38683	14" x 10"	PL



39605	10" x 14"	FB
37635	7" x 10"	SS
38734	10" x 14"	PL



90820	14" x 10"	SS
38684	14" x 10"	PL



39606	10" x 14"	FB
37636	7" x 10"	SS
38711	7" x 10"	PL
38205	7" x 10"	AL

Sign Selection Guide

- FB - Premium fiberglass (B-120)
- SS - Self-sticking polyester (B-302)
- PL - Plastic (B-401)
- AL - Aluminum (B-555)
- BGSS - BradyGlo™ self-stick polyester (B-324)
- BGPL - BradyGlo™ plastic (B-347)

Material Comparison page 408
Sign Legend Index..... page 588



125135	10" x 7"	SS
125138	14" x 10"	SS
125134	10" x 7"	PL
125137	14" x 10"	PL
125133	10" x 7"	AL
125136	14" x 10"	AL



125129	7" x 10"	SS
125132	10" x 14"	SS
125128	7" x 10"	PL
125131	10" x 14"	PL
125127	7" x 10"	AL
125130	10" x 14"	AL



125147	10" x 7"	SS
125150	14" x 10"	SS
90655	10" x 7"	BGPL
125146	10" x 7"	PL
125149	14" x 10"	PL
125145	10" x 7"	AL
125148	14" x 10"	AL



39579	20" x 14"	FB
90797	14" x 10"	SS
38679	14" x 10"	PL
38175	14" x 10"	AL



39590	7" x 10"	FB
39601	10" x 14"	FB
37631	7" x 10"	SS
38706	7" x 10"	PL
38730	10" x 14"	PL
38200	7" x 10"	AL
38227	10" x 14"	AL

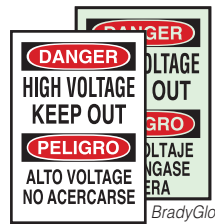

39506	20" x 14"	FB
90793	14" x 10"	SS
90147	10" x 7"	BGSS
90509	14" x 10"	BGSS
90658	10" x 7"	BGPL
90740	14" x 10"	BGPL
38606	14" x 10"	PL
38106	14" x 10"	AL



39531	7" x 10"	FB
39556	10" x 14"	FB
37606	7" x 10"	SS
38656	10" x 14"	PL
38152	10" x 14"	AL



122804	7" x 10"	FB
122780	14" x 10"	FB
39967	20" x 14"	FB
122642	7" x 10"	SS
90803	14" x 10"	SS
122509	7" x 10"	PL
39087	14" x 10"	PL
122398	7" x 10"	AL
38587	14" x 10"	AL



39505	20" x 14"	FB
90542	14" x 10"	SS
38605	14" x 10"	PL
38105	14" x 10"	AL



39555	10" x 14"	FB
38630	7" x 10"	PL
38655	10" x 14"	PL
38127	7" x 10"	AL
38151	10" x 14"	AL



125309	10" x 7"	SS
125312	14" x 10"	SS
125308	10" x 7"	PL
125311	14" x 10"	PL
125307	10" x 7"	AL
125310	14" x 10"	AL



125159	10" x 7"	SS
125162	14" x 10"	SS
125158	10" x 7"	PL
125161	14" x 10"	PL
125157	10" x 7"	AL
125160	14" x 10"	AL



125165	10" x 7"	SS
125168	14" x 10"	SS
125164	10" x 7"	PL
125167	14" x 10"	PL
125163	10" x 7"	AL
125166	14" x 10"	AL



124087	10" x 7"	SS
124090	14" x 10"	SS
124086	10" x 7"	PL
124089	14" x 10"	PL
124085	10" x 7"	AL
124088	14" x 10"	AL



125117	7" x 10"	SS
125120	10" x 14"	SS
125116	7" x 10"	PL
125119	10" x 14"	PL
125115	7" x 10"	AL
125118	10" x 14"	AL



124099	10" x 7"	SS
124102	14" x 10"	SS
124098	10" x 7"	PL
124101	14" x 10"	PL
124097	10" x 7"	AL
124100	14" x 10"	AL

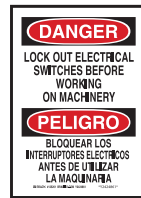

125261	10" x 7"	SS
125264	14" x 10"	SS
125260	10" x 7"	PL
125263	14" x 10"	PL
125259	10" x 7"	AL
125262	14" x 10"	AL



124937	7" x 10"	SS
124940	10" x 14"	SS
124936	7" x 10"	PL
124939	10" x 14"	PL
124935	7" x 10"	AL
124938	10" x 14"	AL

Safety Signs

Bilingual and Spanish-Only Signs

BradyID.com/s36

Bilingual and Spanish-Only Signs (continued)



124081	10" x 7"	SS
124084	14" x 10"	SS
124080	10" x 7"	PL
124083	14" x 10"	PL
124079	10" x 7"	AL
124082	14" x 10"	AL



38865	14" x 10"	PL
38360	14" x 10"	AL



39780	7" x 10"	FB
39804	14" x 10"	FB
37718	7" x 10"	SS
124072	10" x 14"	SS
38892	7" x 10"	PL
124071	10" x 14"	PL
38383	7" x 10"	AL
38403	10" x 14"	AL



125201	10" x 7"	SS
125204	14" x 10"	SS
125200	10" x 7"	PL
125203	14" x 10"	PL
125199	10" x 7"	AL
125202	14" x 10"	AL



125153	10" x 7"	SS
125156	14" x 10"	SS
125152	10" x 7"	PL
125151	10" x 7"	AL
125154	14" x 10"	AL



39978	7" x 10"	FB
37790	7" x 10"	SS
39108	7" x 10"	PL
39135	10" x 14"	PL
37833	10" x 14"	AL



124015	10" x 7"	SS
124018	14" x 10"	SS
124014	10" x 7"	PL
124017	14" x 10"	PL
124013	10" x 7"	AL
124016	14" x 10"	AL



39658	20" x 14"	FB
38767	14" x 10"	PL
38264	14" x 10"	AL



125243	10" x 7"	SS
125246	14" x 10"	SS
125242	10" x 7"	PL
125245	14" x 10"	PL
125241	10" x 7"	AL
125244	14" x 10"	AL



125267	10" x 7"	SS
125270	14" x 10"	SS
125266	10" x 7"	PL
125269	14" x 10"	PL
125265	10" x 7"	AL
125268	14" x 10"	AL



124063	10" x 7"	SS
124066	14" x 10"	SS
124062	10" x 7"	PL
124065	14" x 10"	PL
124061	10" x 7"	AL
124064	14" x 10"	AL



39576	20" x 14"	FB
90543	14" x 10"	SS
38676	14" x 10"	PL
38172	14" x 10"	AL



124943	7" x 10"	SS
124946	10" x 14"	SS
124942	7" x 10"	PL
124945	10" x 14"	PL
124941	7" x 10"	AL
124944	10" x 14"	AL



125207	10" x 7"	SS
125210	14" x 10"	SS
125206	10" x 7"	PL
125209	14" x 10"	PL
125205	10" x 7"	AL
125208	14" x 10"	AL



50270	7" x 10"	PL
-------	----------	----



125105	7" x 10"	SS
125108	10" x 14"	SS
125104	7" x 10"	PL
125107	10" x 14"	PL
125103	7" x 10"	AL
125106	10" x 14"	AL



125099	7" x 10"	SS
125102	10" x 14"	SS
125098	7" x 10"	PL
125101	10" x 14"	PL
125097	7" x 10"	AL
125100	10" x 14"	AL



124949	7" x 10"	SS
124952	10" x 14"	SS
39124	7" x 10"	PL
39151	10" x 14"	PL
124947	7" x 10"	AL
37849	10" x 14"	AL



124093	10" x 7"	SS
124096	14" x 10"	SS
124092	10" x 7"	PL
124095	14" x 10"	PL
124091	10" x 7"	AL
124094	14" x 10"	AL



124105	10" x 7"	SS
124108	14" x 10"	SS
124104	10" x 7"	PL
124107	14" x 10"	PL
124103	10" x 7"	AL
124106	14" x 10"	AL



124141	10" x 7"	SS
124144	14" x 10"	SS
124140	10" x 7"	PL
124143	14" x 10"	PL
124139	10" x 7"	AL
124142	14" x 10"	AL



39811	20" x 14"	FB
90795	14" x 10"	SS
38920	14" x 10"	PL
38411	14" x 10"	AL



39833	7" x 10"	FB
37725	7" x 10"	SS
38457	10" x 14"	AL

Bilingual and Spanish-Only Signs

BradyID.com/s36

Bilingual and Spanish-Only Signs (continued)



125213	10" x 7"	SS
125216	14" x 10"	SS
125212	10" x 7"	PL
125215	14" x 10"	PL
125211	10" x 7"	AL
125214	14" x 10"	AL



125291	10" x 7"	SS
125294	14" x 10"	SS
125290	10" x 7"	PL
125293	14" x 10"	PL
125289	10" x 7"	AL
125292	14" x 10"	AL



90143	10" x 7"	BGSS
90654	10" x 7"	BGPL
90736	14" x 10"	BGPL



124123	10" x 7"	SS
124126	14" x 10"	SS
124122	10" x 7"	PL
124125	14" x 10"	PL
124121	10" x 7"	AL
124124	14" x 10"	AL

Sign Selection Guide

- FB - Premium fiberglass (B-120)
- SS - Self-sticking polyester (B-302)
- PL - Plastic (B-401)
- AL - Aluminum (B-555)
- BGSS - BradyGlo™ self-stick polyester (B-324)
- BGPL - BradyGlo™ plastic (B-347)

Material Comparison page 408
Sign Legend Index..... page 588



39951	20" x 14"	FB
39071	14" x 10"	PL
38571	14" x 10"	AL



125171	10" x 7"	SS
125174	14" x 10"	SS
125170	10" x 7"	PL
125173	14" x 10"	PL
125169	10" x 7"	AL
125172	14" x 10"	AL



125285	7" x 10"	SS
125288	10" x 14"	SS
125284	7" x 10"	PL
125287	10" x 14"	PL
125283	7" x 10"	AL
125286	10" x 14"	AL



125279	7" x 10"	SS
125282	10" x 14"	SS
125278	7" x 10"	PL
125281	10" x 14"	PL
125277	7" x 10"	AL
125280	10" x 14"	AL



124955	7" x 10"	SS
124958	10" x 14"	SS
124954	7" x 10"	PL
124957	10" x 14"	PL
124953	7" x 10"	AL
124956	10" x 14"	AL



125297	10" x 7"	SS
125300	14" x 10"	SS
125296	10" x 7"	PL
125299	14" x 10"	PL
125295	10" x 7"	AL
125298	14" x 10"	AL



125249	10" x 7"	SS
125252	14" x 10"	SS
125248	10" x 7"	PL
125251	14" x 10"	PL
125247	10" x 7"	AL
125250	14" x 10"	AL



39758	20" x 14"	FB
90819	14" x 10"	SS
38866	14" x 10"	PL
38361	14" x 10"	AL



37719	7" x 10"	SS
38893	7" x 10"	PL
38384	7" x 10"	AL
38404	10" x 14"	AL



124961	7" x 10"	SS
124964	10" x 14"	SS
124960	7" x 10"	PL
124963	10" x 14"	PL
124959	7" x 10"	AL
124962	10" x 14"	AL



125255	10" x 7"	SS
125258	14" x 10"	SS
125254	10" x 7"	PL
125257	14" x 10"	PL
125253	10" x 7"	AL
125256	14" x 10"	AL



125273	10" x 7"	SS
125276	14" x 10"	SS
125272	10" x 7"	PL
125275	14" x 10"	PL
125271	10" x 7"	AL
125274	14" x 10"	AL



124075	10" x 7"	SS
124078	14" x 10"	SS
124074	10" x 7"	PL
124077	14" x 10"	PL
124073	10" x 7"	AL
124076	14" x 10"	AL

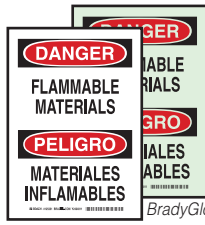

125231	10" x 7"	SS
125234	14" x 10"	SS
90507	14" x 10"	BGSS
90656	10" x 7"	BGPL
125230	10" x 7"	PL
125233	14" x 10"	PL
125229	10" x 7"	AL
125232	14" x 10"	AL



125183	10" x 7"	SS
125186	14" x 10"	SS
125182	10" x 7"	PL
125185	14" x 10"	PL
125181	10" x 7"	AL
125184	14" x 10"	AL



125177	10" x 7"	SS
125180	14" x 10"	SS
125176	10" x 7"	PL
125179	14" x 10"	PL
125175	10" x 7"	AL
125178	14" x 10"	AL



39503	20" x 14"	FB
38603	14" x 10"	PL
38103	14" x 10"	AL

Safety Signs

Bilingual and Spanish-Only Signs

BradyID.com/s36

Bilingual and Spanish-Only Signs (continued)



39528	7" x 10"	FB
39553	14" x 10"	FB
37603	7" x 10"	SS
38628	7" x 10"	PL
38653	10" x 14"	PL



125237	10" x 7"	SS
125240	14" x 10"	SS
125236	10" x 7"	PL
125239	14" x 10"	PL
125235	10" x 7"	AL
125238	14" x 10"	AL



124117	10" x 7"	SS
124120	14" x 10"	SS
124116	10" x 7"	PL
124119	14" x 10"	PL
124115	10" x 7"	AL
124118	14" x 10"	AL



39504	20" x 14"	FB
90810	14" x 10"	SS
90734	14" x 10"	BGPL
38604	14" x 10"	PL
38104	14" x 10"	AL



39529	7" x 10"	FB
39554	10" x 14"	FB
37604	7" x 10"	SS
38629	7" x 10"	PL
38654	10" x 14"	PL
38150	10" x 14"	AL



122803	7" x 10"	FB
122779	14" x 10"	FB
39876	20" x 14"	FB
122641	7" x 10"	SS
90666	14" x 10"	SS
122508	7" x 10"	PL
38990	14" x 10"	PL
122397	7" x 10"	AL
38478	14" x 10"	AL



39894	7" x 10"	FB
39912	10" x 14"	FB
37758	7" x 10"	SS
39008	7" x 10"	PL
39026	10" x 14"	PL
38514	10" x 14"	AL



39817	20" x 14"	FB
38928	14" x 10"	PL
38417	14" x 10"	AL



39860	14" x 10"	FB
37737	7" x 10"	SS
38973	10" x 14"	PL
38440	7" x 10"	AL
38463	10" x 14"	AL



125315	10" x 7"	SS
125318	14" x 10"	SS
125314	10" x 7"	PL
125317	14" x 10"	PL
125313	10" x 7"	AL
125316	14" x 10"	AL



125189	7" x 10"	SS
125192	10" x 14"	SS
125188	7" x 10"	PL
125191	10" x 14"	PL
125187	7" x 10"	AL
125190	10" x 14"	AL



38867	14" x 10"	PL
38362	14" x 10"	AL



37720	7" x 10"	SS
-------	----------	----



124147	10" x 7"	SS
124150	14" x 10"	SS
124146	10" x 7"	PL
124149	14" x 10"	PL
124145	10" x 7"	AL
124148	14" x 10"	AL



125123	7" x 10"	SS
125126	10" x 14"	SS
125122	7" x 10"	PL
125125	10" x 14"	PL
125121	7" x 10"	AL
125124	10" x 14"	AL



125141	7" x 10"	SS
125144	10" x 14"	SS
125140	7" x 10"	PL
125143	10" x 14"	PL
125139	7" x 10"	AL
125142	10" x 14"	AL



125195	10" x 7"	SS
125198	14" x 10"	SS
125194	10" x 7"	PL
125197	14" x 10"	PL
125193	10" x 7"	AL
125196	14" x 10"	AL



125219	10" x 7"	SS
125222	14" x 10"	SS
125218	10" x 7"	PL
125221	14" x 10"	PL
125217	10" x 7"	AL
125220	14" x 10"	AL



124045	10" x 7"	SS
124048	14" x 10"	SS
124044	10" x 7"	PL
124047	14" x 10"	PL
124043	10" x 7"	AL
124046	14" x 10"	AL



39954	20" x 14"	FB
39074	14" x 10"	PL
38574	14" x 10"	AL



39981	7" x 10"	FB
39161	14" x 10"	FB
37793	7" x 10"	SS
39111	7" x 10"	PL
39138	10" x 14"	PL
37809	7" x 10"	AL



39756	20" x 14"	FB
38864	14" x 10"	PL
38359	14" x 10"	AL



39803	14" x 10"	FB
38914	10" x 14"	PL



125111	7" x 10"	SS
125114	10" x 14"	SS
125110	7" x 10"	PL
125113	10" x 14"	PL
125109	7" x 10"	AL
125112	10" x 14"	AL

Bilingual and Spanish-Only Signs

BradyID.com/s36

Bilingual and Spanish-Only Signs (continued)



125303	10" x 7"	SS
125306	14" x 10"	SS
125302	10" x 7"	PL
125305	14" x 10"	PL
125301	10" x 7"	AL
125304	14" x 10"	AL



90149	10" x 7"	BGSS
90680	10" x 7"	BGPL



124009	10" x 7"	SS
124012	14" x 10"	SS
124008	10" x 7"	PL
124011	14" x 10"	PL
124007	10" x 7"	AL
124010	14" x 10"	AL



125495	7" x 10"	SS
125498	10" x 14"	SS
125494	7" x 10"	PL
125497	10" x 14"	PL
125493	7" x 10"	AL
125496	10" x 14"	AL

Sign Selection Guide

- FB - Premium fiberglass (B-120)
- SS - Self-sticking polyester (B-302)
- PL - Plastic (B-401)
- AL - Aluminum (B-555)
- BGSS - BradyGlo™ self-stick polyester (B-324)
- BGPL - BradyGlo™ plastic (B-347)

Material Comparison page 408
Sign Legend Index..... page 588



39961	20" x 14"	FB
90674	14" x 10"	SS
39081	14" x 10"	PL
38581	14" x 10"	AL



37800	7" x 10"	SS
39145	10" x 14"	PL
37843	10" x 14"	AL



125063	10" x 7"	SS
125066	14" x 10"	SS
125062	10" x 7"	PL
125065	14" x 10"	PL
125061	10" x 7"	AL
125064	14" x 10"	AL



124977	10" x 7"	SS
125000	14" x 10"	SS
124996	10" x 7"	PL
124999	14" x 10"	PL
124995	10" x 7"	AL
124998	14" x 10"	AL

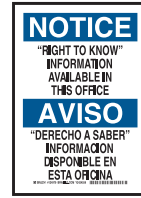

124979	10" x 7"	SS
124982	14" x 10"	SS
124978	10" x 7"	PL
124981	14" x 10"	PL
124977	10" x 7"	AL
124980	14" x 10"	AL



124991	10" x 7"	SS
124994	14" x 10"	SS
124990	10" x 7"	PL
124993	14" x 10"	PL
124989	10" x 7"	AL
124992	14" x 10"	AL



125033	10" x 7"	SS
125036	14" x 10"	SS
125032	10" x 7"	PL
125035	14" x 10"	PL
125031	10" x 7"	AL
125034	14" x 10"	AL



124033	10" x 7"	SS
124036	14" x 10"	SS
124032	10" x 7"	PL
124035	14" x 10"	PL
124031	10" x 7"	AL
124034	14" x 10"	AL

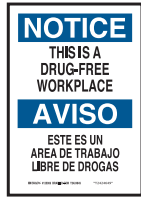

125069	10" x 7"	SS
125072	14" x 10"	SS
125068	10" x 7"	PL
125071	14" x 10"	PL
125067	10" x 7"	AL
125070	14" x 10"	AL



124039	10" x 7"	SS
124042	14" x 10"	SS
124038	10" x 7"	PL
124041	14" x 10"	PL
124037	10" x 7"	AL
124040	14" x 10"	AL



125009	7" x 10"	SS
125012	10" x 14"	SS
125008	7" x 10"	PL
125011	10" x 14"	PL
125007	7" x 10"	AL
125010	10" x 14"	AL



14216	14" x 10"	SS
14218	14" x 10"	PL
14219	14" x 10"	AL



122809	7" x 10"	FB
122785	14" x 10"	FB
122647	7" x 10"	SS
90807	14" x 10"	SS
122514	7" x 10"	PL
38937	14" x 10"	PL
122403	7" x 10"	AL
38425	14" x 10"	AL



14218	14" x 10"	FB
14216	14" x 10"	SS
87714	14" x 10"	PL
14219	14" x 10"	AL



37748	7" x 10"	SS
38979	10" x 14"	PL



125015	10" x 7"	SS
125018	14" x 10"	SS
125014	10" x 7"	PL
125017	14" x 10"	PL
125013	10" x 7"	AL
125016	14" x 10"	AL



125075	10" x 7"	SS
125078	14" x 10"	SS
125074	10" x 7"	PL
125077	14" x 10"	PL
125073	10" x 7"	AL
125076	14" x 10"	AL



125081	10" x 7"	SS
125084	14" x 10"	SS
125080	10" x 7"	PL
125083	14" x 10"	PL
125079	10" x 7"	AL
125082	14" x 10"	AL

Safety Signs

Bilingual and Spanish-Only Signs

BradyID.com/s36

Bilingual and Spanish-Only Signs (continued)



39718	7" x 10"	FB
39731	10" x 14"	FB
37690	7" x 10"	SS
38819	7" x 10"	PL
38837	10" x 14"	PL
38329	7" x 10"	AL
38338	10" x 14"	AL



90811	14" x 10"	SS
38803	14" x 10"	PL
38313	14" x 10"	AL



125039	7" x 10"	SS
125042	10" x 14"	SS
125038	7" x 10"	PL
125041	10" x 14"	PL
125037	7" x 10"	AL
125040	10" x 14"	AL



38875	7" x 10"	PL
38902	10" x 14"	PL
38368	7" x 10"	AL



125051	10" x 7"	SS
125054	14" x 10"	SS
125050	10" x 7"	PL
125053	14" x 10"	PL
125049	10" x 7"	AL
125052	14" x 10"	AL



125003	7" x 10"	SS
125006	10" x 14"	SS
125002	7" x 10"	PL
125005	10" x 14"	PL
125049	10" x 7"	AL
125004	10" x 14"	AL



124985	10" x 7"	SS
124988	14" x 10"	SS
124984	10" x 7"	PL
124987	14" x 10"	PL
124983	10" x 7"	AL
124986	14" x 10"	AL



125045	10" x 7"	SS
125048	14" x 10"	SS
125044	10" x 7"	PL
125047	14" x 10"	PL
125043	10" x 7"	AL
125046	14" x 10"	AL



124973	10" x 7"	SS
124976	14" x 10"	SS
124972	10" x 7"	PL
124975	14" x 10"	PL
124971	10" x 7"	AL
124974	14" x 10"	AL



39740	20" x 14"	FB
90668	14" x 10"	SS
38848	14" x 10"	PL
38347	10" x 14"	AL



122810	7" x 10"	FB
122786	14" x 10"	FB
39514	20" x 14"	FB
122648	7" x 10"	SS
90544	14" x 10"	SS
122515	7" x 10"	PL
38614	14" x 10"	PL
122404	7" x 10"	AL
38114	14" x 10"	AL



39054	7" x 10"	PL
39055	10" x 14"	PL
38160	10" x 14"	AL



125057	10" x 7"	SS
125060	14" x 10"	SS
125056	10" x 7"	PL
125059	14" x 10"	PL
125055	10" x 7"	AL
125058	14" x 10"	AL



125027	10" x 7"	SS
125030	14" x 10"	SS
125026	10" x 7"	PL
125029	14" x 10"	PL
125025	10" x 7"	AL
125028	14" x 10"	AL



125021	10" x 7"	SS
125024	14" x 10"	SS
125020	10" x 7"	PL
125023	14" x 10"	PL
125019	10" x 7"	AL
125022	14" x 10"	AL



124967	7" x 10"	SS
124970	10" x 14"	SS
124966	7" x 10"	PL
124969	10" x 14"	PL
124965	7" x 10"	AL
124968	10" x 14"	AL



125489	7" x 10"	SS
125492	10" x 14"	SS
125488	7" x 10"	PL
125491	10" x 14"	PL
125487	7" x 10"	AL
125490	10" x 14"	AL



122914	7" x 10"	FB
122758	10" x 14"	FB
39512	20" x 14"	FB
90667	14" x 10"	SS
38612	14" x 10"	PL
38112	14" x 10"	AL



39537	7" x 10"	FB
37612	7" x 10"	SS
38637	7" x 10"	PL
38662	10" x 14"	PL
38134	7" x 10"	AL
38158	10" x 14"	AL



125087	10" x 7"	SS
125090	14" x 10"	SS
125086	10" x 7"	PL
125089	14" x 10"	PL
125085	10" x 7"	AL
125088	14" x 10"	AL



39613	20" x 14"	FB
90808	14" x 10"	SS
38188	14" x 10"	AL



39639	10" x 14"	FB
37645	7" x 10"	SS
38742	10" x 14"	PL
38239	10" x 14"	AL

Safety Signs

Bilingual and Spanish-Only Signs

BradyID.com/s36

Bilingual and Spanish-Only Signs (continued)



124165	7" x 10"	SS
124168	10" x 14"	SS
124164	7" x 10"	PL
124167	10" x 14"	PL
124163	7" x 10"	AL
124166	10" x 14"	AL

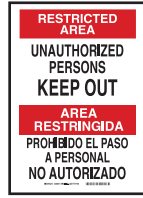

38616	14" x 10"	PL
-------	-----------	----



37616	7" x 10"	SS
38640	7" x 10"	PL
38665	10" x 14"	PL
38162	10" x 14"	AL



124003	10" x 7"	SS
124006	14" x 10"	SS
124002	10" x 7"	PL
124005	14" x 10"	PL
124001	10" x 7"	AL
124004	14" x 10"	AL

Sign Selection Guide

- FB - Premium fiberglass (B-120)
- SS - Self-sticking polyester (B-302)
- PL - Plastic (B-401)
- AL - Aluminum (B-555)
- BGSS - BradyGlo™ self-stick polyester (B-324)
- BGPL - BradyGlo™ plastic (B-347)

Material Comparison page 408
Sign Legend Index..... page 588



124901	7" x 10"	SS
124904	10" x 14"	SS
124900	7" x 10"	PL
124903	10" x 14"	PL
124899	7" x 10"	AL
124902	10" x 14"	AL



39517	20" x 14"	FB
124895	10" x 7"	SS
124898	14" x 10"	SS
124894	10" x 7"	PL
38617	14" x 10"	PL
124893	10" x 7"	AL
38117	14" x 10"	AL



39542	7" x 10"	FB
39567	14" x 10"	FB
37617	7" x 10"	SS
124894	10" x 7"	PL
38641	7" x 10"	PL
38666	10" x 14"	PL
38138	7" x 10"	AL
38163	10" x 14"	AL



39769	7" x 10"	FB
39789	10" x 14"	FB
37703	7" x 10"	SS
38877	7" x 10"	PL
38904	10" x 14"	PL
38370	7" x 10"	AL
38392	10" x 14"	AL



39742	20" x 14"	FB
90791	14" x 10"	SS
38850	14" x 10"	PL
38349	14" x 10"	AL



38996	14" x 10"	PL
38484	14" x 10"	AL



125501	7" x 10"	SS
125504	10" x 14"	SS
125500	7" x 10"	PL
125503	10" x 14"	PL
125499	7" x 10"	AL
125502	10" x 14"	AL



122808	10" x 7"	FB
122784	14" x 10"	FB
122646	10" x 7"	SS
122631	14" x 10"	SS
122513	10" x 7"	PL
38993	14" x 10"	PL
122402	10" x 7"	AL
38481	14" x 10"	AL



39029	10" x 14"	PL
-------	-----------	----



125543	7" x 10"	SS
125546	10" x 14"	SS
125542	7" x 10"	PL
125545	10" x 14"	PL
125541	7" x 10"	AL
125544	10" x 14"	AL



123991	7" x 10"	SS
123994	10" x 14"	SS
123990	7" x 10"	PL
123993	10" x 14"	PL
123989	7" x 10"	AL
123992	10" x 14"	AL



124135	10" x 7"	SS
124138	14" x 10"	SS
124134	10" x 7"	PL
124137	14" x 10"	PL
124133	10" x 7"	AL
124136	14" x 10"	AL

Safety Signs



124027	10" x 7"	SS
124030	14" x 10"	SS
124026	10" x 7"	PL
124029	14" x 10"	PL
124025	10" x 7"	AL
124028	14" x 10"	AL



124564	18" x 4"	SS
124563	18" x 4"	PL
124562	18" x 4"	AL



38756	14" x 10"	PL
38253	14" x 10"	AL



37661	14" x 5"	SS
-------	----------	----



39649	14" x 20"	FB
90821	14" x 20"	SS



37657	12" x 9"	SS
38775	14" x 10"	PL
38272	14" x 10"	AL

Bilingual and Spanish-Only Signs

BradyID.com/s36

Bilingual and Spanish-Only Signs (continued)



39880	20" x 14"	FB
90804	14" x 10"	SS
90156	10" x 7"	BGSS
90518	14" x 10"	BGSS
90687	10" x 7"	BGPL
38994	14" x 10"	PL
38482	14" x 10"	AL



39012	7" x 10"	PL
-------	----------	----

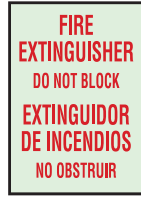

90158	10" x 7"	BGSS
90520	14" x 10"	BGSS
90751	14" x 10"	BGPL



124159	10" x 7"	SS
124162	14" x 10"	SS
124158	10" x 7"	PL
124161	14" x 10"	PL
124157	10" x 7"	AL
124160	14" x 10"	AL



125531	10" x 7"	SS
125534	14" x 10"	SS
125530	10" x 7"	PL
125533	14" x 10"	PL
125529	10" x 7"	AL
125532	14" x 10"	AL



124153	10" x 7"	SS
124156	14" x 10"	SS
124152	10" x 7"	PL
124155	14" x 10"	PL
124151	10" x 7"	AL
124154	14" x 10"	AL



125537	10" x 7"	SS
125540	14" x 10"	SS
125536	10" x 7"	PL
125539	14" x 10"	PL
125535	10" x 7"	AL
125538	14" x 10"	AL



39881	20" x 14"	FB
38995	14" x 10"	PL
38483	14" x 10"	AL



47655	10" x 7"	SS
47657	10" x 7"	PL
47658	10" x 7"	AL



47643	10" x 7"	SS
47645	10" x 7"	PL
47646	10" x 7"	AL



37660	14" x 5"	SS
-------	----------	----



125513	10" x 7"	SS
125516	14" x 10"	SS
125512	10" x 7"	PL
125515	14" x 10"	PL
125511	10" x 7"	AL
125514	14" x 10"	AL



39883	20" x 14"	FB
38997	14" x 10"	PL
38485	14" x 10"	AL



124021	10" x 7"	SS
124024	14" x 10"	SS
124020	10" x 7"	PL
124023	14" x 10"	PL
124019	10" x 7"	AL
124022	14" x 10"	AL



90670	14" x 10"	SS
90160	10" x 7"	BGSS
90522	14" x 10"	BGSS
90691	10" x 7"	BGPL
38800	14" x 10"	PL
38310	14" x 10"	AL



37686	7" x 10"	SS
38816	7" x 10"	PL



124171	10" x 7"	SS
124174	14" x 10"	SS
124170	10" x 7"	PL
124173	14" x 10"	PL
124169	10" x 7"	AL
124172	14" x 10"	AL



39820	14" x 20"	FB
38931	14" x 10"	PL
38420	10" x 14"	AL



37740	7" x 10"	SS
38976	10" x 14"	PL



122802	7" x 10"	FB
122712	10" x 14"	FB
39821	14" x 20"	FB
122640	7" x 10"	SS
122507	7" x 10"	PL
38933	10" x 14"	PL
122396	7" x 10"	AL
122347	10" x 14"	AL



37743	10" x 7"	SS
38955	14" x 10"	PL
38444	14" x 10"	AL

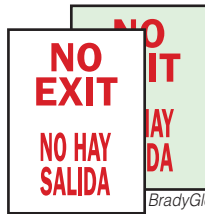

39698	20" x 14"	FB
90662	14" x 10"	SS
90159	10" x 7"	BGSS
90521	14" x 10"	BGSS
90690	10" x 7"	BGPL
90752	14" x 10"	BGPL
38799	14" x 10"	PL
38309	14" x 10"	AL



124129	10" x 7"	SS
124132	14" x 10"	SS
124128	10" x 7"	PL
124131	14" x 10"	PL
124127	10" x 7"	AL
124130	14" x 10"	AL



125549	7" x 10"	SS
125552	10" x 14"	SS
125548	7" x 10"	PL
125551	10" x 14"	PL
125547	7" x 10"	AL
125550	10" x 14"	AL

Bilingual and Spanish-Only Signs

BradyID.com/s36

Bilingual and Spanish-Only Signs (continued)



90555	10" x 7"	BGSS
90188	14" x 10"	BGSS
90633	10" x 7"	BGPL
90949	14" x 10"	BGPL



124572	18" x 18"	PL
124574	24" x 24"	PL
124571	18" x 18"	AL
124573	24" x 24"	AL



125093	10" x 7"	SS
125096	14" x 10"	SS
125092	10" x 7"	PL
125095	14" x 10"	PL
125091	10" x 7"	AL
125094	14" x 10"	AL



124111	10" x 7"	SS
124114	14" x 10"	SS
124110	10" x 7"	PL
124113	14" x 10"	PL
124109	10" x 7"	AL
124112	14" x 10"	AL

Sign Selection Guide

- FB - Premium fiberglass (B-120)
- SS - Self-sticking polyester (B-302)
- PL - Plastic (B-401)
- AL - Aluminum (B-555)
- BGSS - BradyGlo™ self-stick polyester (B-324)
- BGPL - BradyGlo™ plastic (B-347)

Material Comparison page 408
Sign Legend Index..... page 588



124644	12" x 18"	PL
124646	18" x 24"	PL
124643	12" x 18"	AL
124645	18" x 24"	AL



124907	10" x 7"	SS
124910	14" x 10"	SS
124906	10" x 7"	PL
124909	14" x 10"	PL
124905	10" x 7"	AL
124908	14" x 10"	AL



124177	7" x 10"	SS
124180	10" x 14"	SS
124176	7" x 10"	PL
124179	10" x 14"	PL
124175	7" x 10"	AL
124178	10" x 14"	AL



125525	10" x 7"	SS
125528	14" x 10"	SS
125524	10" x 7"	PL
125527	14" x 10"	PL
125523	10" x 7"	AL
125526	14" x 10"	AL



125519	10" x 7"	SS
125522	14" x 10"	SS
125518	10" x 7"	PL
125521	14" x 10"	PL
125517	10" x 7"	AL
125520	14" x 10"	AL



90685	10" x 7"	BGPL
-------	----------	------



39696	20" x 14"	FB
90805	14" x 10"	SS
90155	10" x 7"	BGSS
90157	14" x 10"	BGSS
90686	10" x 7"	BGPL
38797	14" x 10"	PL
38307	14" x 10"	AL



37683	7" x 10"	SS
38813	7" x 10"	PL
38831	10" x 14"	PL
38323	7" x 10"	AL



90750	14" x 10"	BGPL
-------	-----------	------



125507	7" x 10"	SS
125510	10" x 14"	SS
125506	7" x 10"	PL
125509	10" x 14"	PL
125505	7" x 10"	AL
125508	10" x 14"	AL

Safety Signs

Design custom signs online
BradyID.com/customsigns



Biohazard Signs

Brady biohazard signs are used to identify equipment, rooms and materials which contain or are contaminated with hazardous agents. Biohazard marking is required by safety code 1910.1030(g)(1), which states that warning labels must be affixed to containers of regulated waste, refrigerators and freezers containing blood or other potentially infectious material.

Regulations

OSHA 29 CFR 1910.1030

Bloodborne Pathogens:

Labels required for containers and shipments. Employers to post biohazard signs at the entrance to work areas.

DOT 49 CFR 172.400(b)

Labeling Requirements:

Labeling is required for infectious substances which meets one or more hazard classifications.

UN2814 Infectious

Substances:

Ebola virus defined as Category A infectious substance.



126692	7" x 10"	SS
126695	10" x 14"	SS
126691	7" x 10"	PL
126694	10" x 14"	PL
126690	7" x 10"	AL
126693	10" x 14"	AL



126686	7" x 10"	SS
126689	10" x 14"	SS
126685	7" x 10"	PL
126688	10" x 14"	PL
126684	7" x 10"	AL
126687	10" x 14"	AL



126680	7" x 10"	SS
126683	10" x 14"	SS
126679	7" x 10"	PL
126682	10" x 14"	PL
126678	7" x 10"	AL
126681	10" x 14"	AL



126668	7" x 10"	SS
126671	10" x 14"	SS
126667	7" x 10"	PL
126670	10" x 14"	PL
126666	7" x 10"	AL
126669	10" x 14"	AL



126674	7" x 10"	SS
126677	10" x 14"	SS
126673	7" x 10"	PL
126676	10" x 14"	PL
126672	7" x 10"	AL
126675	10" x 14"	AL



62550	7" x 10"	FB
62812	10" x 14"	FB
21800	7" x 10"	PL
26575	10" x 14"	PL
83928	3.5" x 5"	SS
83753	7" x 10"	SS
46753	10" x 14"	AL



90704	10" x 7"	BGPL
-------	----------	------



69768	10" x 14"	FB
25742	7" x 10"	PL
25743	10" x 14"	PL
89170	3.5" x 5"	SS
85553	7" x 10"	SS
85554	10" x 14"	SS
43319	7" x 10"	AL
43320	10" x 14"	AL



126649	7" x 10"	PL
126652	10" x 14"	PL
126650	7" x 10"	SS
126653	10" x 14"	SS
126648	7" x 10"	AL
126651	10" x 14"	AL



69767	10" x 14"	FB
22211	7" x 10"	PL
22212	10" x 14"	PL
84216	7" x 10"	SS
84217	10" x 14"	SS
40775	7" x 10"	AL
40776	10" x 14"	AL



126625	10" x 7"	PL
126628	14" x 10"	PL
126626	10" x 7"	SS
126629	14" x 10"	SS
126624	10" x 7"	AL
126627	14" x 10"	AL



126643	10" x 7"	PL
126646	14" x 10"	PL
126644	10" x 7"	SS
126647	14" x 10"	SS
126642	10" x 7"	AL
126645	14" x 10"	AL



126637	10" x 7"	PL
126640	14" x 10"	PL
126638	10" x 7"	SS
126641	14" x 10"	SS
126636	10" x 7"	AL
126639	14" x 10"	AL



126631	10" x 7"	PL
126634	14" x 10"	PL
126632	10" x 7"	SS
126635	14" x 10"	SS
126630	10" x 7"	AL
126633	14" x 10"	AL



126655	10" x 7"	PL
126658	14" x 10"	PL
126656	10" x 7"	SS
126659	14" x 10"	SS
126654	10" x 7"	AL
126657	14" x 10"	AL



69815	14" x 10"	FB
25780	10" x 7"	PL
25781	14" x 10"	PL
89169	5" x 3.5"	SS
89163	10" x 7"	SS
89164	14" x 10"	SS
43357	10" x 7"	AL
43358	14" x 10"	AL



69789	7" x 17"	FB
-------	----------	----



126661	7" x 10"	PL
126664	10" x 14"	PL
126662	7" x 10"	SS
126665	10" x 14"	SS
126660	7" x 10"	AL
126663	10" x 14"	AL



69813	14" x 10"	FB
89158	10" x 7"	SS
89159	14" x 10"	SS

View page 303 for biohazard labels, tape and waste disposal bags.



Blank Signs

BradyID.com/s36

Blank Signs

Brady offers a variety of blank signs and panels that can be customized to your specific needs. They can be used to create custom safety signs, alert signs, admittance signs and more.

Sign Selection Guide

- FB** - Premium fiberglass (B-120)
- SS** - Self-sticking polyester (B-302)
- PL** - Plastic (B-401)
- AL** - Aluminum (B-555)
- BGSS** - BradyGlo self-sticking (B-324)
- BGPL** - BradyGlo plastic (B-347)
- TG** - Polycoated tagstock (B-101)
- TMP** - Temporary fluted polypropylene (B-836)

Material Comparison Guide on page 408



65263	7" x 10"	TG
65264	10" x 14"	TG
76005	7" x 10"	FB
47002	10" x 14"	FB
76006	14" x 20"	FB
88918	7" x 10"	SS
88919	10" x 14"	SS
25356	7" x 10"	PL
25357	10" x 14"	PL
42933	7" x 10"	AL
42934	10" x 14"	AL
78063	10" x 14"	TMP
78064	14" x 20"	TMP



65261	7" x 10"	TG
65262	10" x 14"	TG
76009	7" x 10"	FB
47004	10" x 14"	FB
76013	14" x 20"	FB
88925	7" x 10"	SS
88926	10" x 14"	SS
25360	7" x 10"	PL
25361	10" x 14"	PL
42937	7" x 10"	AL
42938	10" x 14"	AL
78066	10" x 14"	TMP
78067	14" x 20"	TMP
77995	18" x 24"	TMP



65266	10" x 14"	TG
76015	7" x 10"	FB
47014	10" x 14"	FB
76021	14" x 20"	FB
88932	7" x 10"	SS
88933	10" x 14"	SS
25364	7" x 10"	PL
25365	10" x 14"	PL
42941	7" x 10"	AL
42942	10" x 14"	AL
77997	18" x 24"	TMP



69806	10" x 14"	FB
88944	7" x 10"	SS
88945	10" x 14"	SS
25372	7" x 10"	PL
25373	10" x 14"	PL
42949	7" x 10"	AL
42950	10" x 14"	AL



75990	10" x 14"	FB
88942	7" x 10"	SS
25370	7" x 10"	PL
25371	10" x 14"	PL
42948	10" x 14"	AL
78073	14" x 20"	TMP

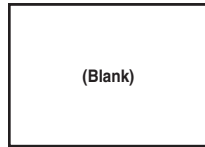

76063	7" x 10"	FB
47000	10" x 14"	FB
76034	14" x 20"	FB
76036	20" x 28"	FB
88948	7" x 10"	SS
88949	10" x 14"	SS
25963	3.5" x 5"	PL
25960	5" x 7"	PL
25376	7" x 10"	PL
25377	10" x 14"	PL
42953	7" x 10"	AL
42954	10" x 14"	AL
78084	7" x 10"	TMP
78086	14" x 20"	TMP
77998	18" x 24"	TMP



88915	2.25" x 9"	SS
-------	------------	----



88922	2.25" x 9"	SS
88924	5" x 14"	SS



88930	3.5" x 10"	SS
-------	------------	----



89115	2.25" x 9"	SS
-------	------------	----



88941	2.25" x 9"	SS
-------	------------	----

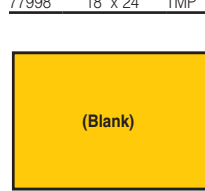

88058	2.25" x 9"	SS
88059	3.5" x 10"	SS



88061	2.25" x 9"	SS
88063	5" x 14"	SS



95563	14" x 20"	FB
89006	10" x 14"	SS



88064	2.25" x 9"	SS
88065	3.5" x 10"	SS
88066	5" x 14"	SS



76064	7" x 10"	FB
76040	10" x 14"	FB
76045	14" x 20"	FB
76050	20" x 28"	FB
88946	7" x 10"	SS
88947	10" x 14"	SS
25964	3.5" x 5"	PL
25961	5" x 7"	PL
25374	7" x 10"	PL
25375	10" x 14"	PL
42951	7" x 10"	AL
42952	10" x 14"	AL
78083	14" x 20"	TMP
77999	18" x 24"	TMP

76064	7" x 10"	FB
76040	10" x 14"	FB
76045	14" x 20"	FB
76050	20" x 28"	FB
88946	7" x 10"	SS
88947	10" x 14"	SS
25964	3.5" x 5"	PL
25961	5" x 7"	PL
25374	7" x 10"	PL
25375	10" x 14"	PL
42951	7" x 10"	AL
42952	10" x 14"	AL
78083	14" x 20"	TMP
77999	18" x 24"	TMP



76097	7" x 10"	FB
76098	10" x 14"	FB
88052	7" x 10"	SS
88053	10" x 14"	SS
25971	7" x 10"	PL
25972	10" x 14"	PL



76100	7" x 10"	FB
76101	10" x 14"	FB
88054	7" x 10"	SS
25973	7" x 10"	PL
42252	7" x 10"	AL

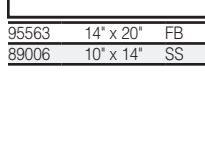

95563	14" x 20"	FB
89006	10" x 14"	SS



69825	10" x 14"	FB
88056	7" x 10"	SS
88057	10" x 14"	SS
25975	7" x 10"	PL
42254	7" x 10"	AL
42255	10" x 14"	AL



76061	10" x 14"	FB
88914	10" x 14"	SS

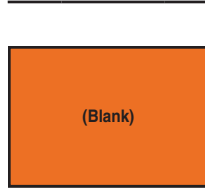

88935	10" x 14"	SS
25366	7" x 10"	PL



74871	10" x 14"	FB
88927	7" x 10"	SS
88928	10" x 14"	SS
25362	7" x 10"	PL

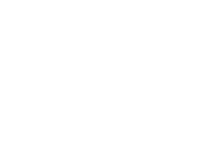

95563	14" x 20"	FB
89006	10" x 14"	SS



65825	10" x 14"	FB
65828	10" x 14"	AL



76053	10" x 14"	FB
76056	14" x 20"	FB
88939	7" x 10"	SS
25368	7" x 10"	PL
25369	10" x 14"	PL

69809	10" x 14"	FB
69810	14" x 20"	FB
89113	7" x 10"	SS
25962	5" x 7"	PL
25886	10" x 14"	PL
43462	7" x 10"	AL



95559	10" x 14"	FB
89001	7" x 10"	SS
25406	7" x 10"	PL
25407	10" x 14"	PL



42986	10" x 14"	AL
-------	-----------	----



95563	14" x 20"	FB
89006	10" x 14"	SS



65825	10" x 14"	FB
65828	10" x 14"	AL

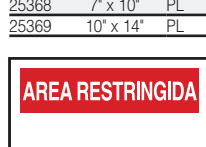

25413	10" x 14"	PL
-------	-----------	----

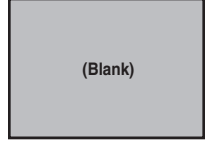

65159	18" x 18"	B-959
-------	-----------	-------

Safety Signs

Braille (ADA) Signs

Brady Braille signs meet ADA requirements and ICC / ANSI 117.1 specifications for identifying permanent rooms within a building. Braille signs are required by law under the Americans with Disabilities Act. These Braille signs are available in more than 15 stock legends to identify restrooms, elevators, exits, safety equipment and more.

Brady Braille signs are made of non-glare rigid plastic (B-81) material. Double-sided tape included.

Regulations

All Braille signs feature a true dome-shaped Braille dot to meet ICC / ANSI 117.1 specifications.

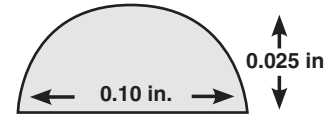

 70123 6" x 6" B-81 Black	 70109 8" x 8" B-81 Black	 70167 2" x 8" B-81 Brown	 70161 8" x 8" B-81 Black 73447 8" x 8" B-81 Brown	 70115 2" x 8" B-81 Black 70141 2" x 8" B-81 Brown	 70105 8" x 8" B-81 Black																				
 70102 8" x 8" B-81 Black 70128 8" x 8" B-81 Brown	 70112 2" x 8" B-81 Black 70138 2" x 8" B-81 Brown	 73445 8" x 8" B-81 Brown	 70117 2" x 8" B-81 Black	 70103 8" x 8" B-81 Black 70129 8" x 8" B-81 Brown	 73400 8" x 8" B-81 Black 70127 8" x 8" B-81 Brown																				
 70110 8" x 8" B-81 Black 70136 8" x 8" B-81 Brown	 70137 2" x 8" B-81 Brown	<h3>Braille (ADA) Sign Frames</h3> <ul style="list-style-type: none"> • Square cornered frames available to fit all Braille (ADA) signs above <table border="1"> <thead> <tr> <th>Catalog #</th> <th>Description</th> <th>Size</th> <th>Color</th> </tr> </thead> <tbody> <tr> <td>70153</td> <td>Braille Sign Frame</td> <td>2" x 8"</td> <td>Black</td> </tr> <tr> <td>73446</td> <td>Braille Sign Frame</td> <td>2" x 8"</td> <td>Brown</td> </tr> <tr> <td>73403</td> <td>Braille Sign Frame</td> <td>8" x 8"</td> <td>Black</td> </tr> <tr> <td>70152</td> <td>Braille Sign Frame</td> <td>8" x 8"</td> <td>Brown</td> </tr> </tbody> </table>				Catalog #	Description	Size	Color	70153	Braille Sign Frame	2" x 8"	Black	73446	Braille Sign Frame	2" x 8"	Brown	73403	Braille Sign Frame	8" x 8"	Black	70152	Braille Sign Frame	8" x 8"	Brown
Catalog #	Description	Size	Color																						
70153	Braille Sign Frame	2" x 8"	Black																						
73446	Braille Sign Frame	2" x 8"	Brown																						
73403	Braille Sign Frame	8" x 8"	Black																						
70152	Braille Sign Frame	8" x 8"	Brown																						



California (ADA) Restroom Signs

- California ADA standards specify circular or triangular signs be mounted onto restroom doors
- Double-sided foam tape included

 106179 10" x 11" Plastic Blue	 106182 10" x 11" Plastic Blue	 106181 12 dia. Plastic Blue	 106180 12 dia. Plastic Blue 106186 12 dia. Plastic Black	 106183 13 dia. Plastic Black	 106184 12 dia. Plastic Blue
-----------------------------------	-----------------------------------	---------------------------------	---	----------------------------------	---------------------------------

Chemical and Hazardous Material Signs

BradyID.com/s36

Chemical and Hazardous Material Signs

Brady's chemical signs are used to identify your plant's chemical storage and hazardous materials areas. These signs keep your employees safe by clearly indicating where and how chemicals are kept.



125888	7' x 10'	SS
125891	10' x 14'	SS
125887	7' x 10'	PL
125890	10' x 14'	PL
125886	7' x 10'	AL
125889	10' x 14'	AL



69371	10' x 14'	FB
84285	7' x 10'	SS
84286	10' x 14'	SS
22262	7' x 10'	PL
22263	10' x 14'	PL
40826	7' x 10'	AL
40827	10' x 14'	AL



125894	7' x 10'	SS
125897	10' x 14'	SS
125893	7' x 10'	PL
125896	10' x 14'	PL
125892	7' x 10'	AL
125895	10' x 14'	AL



76080	10' x 14'	FB
85382	7' x 10'	SS
85383	10' x 14'	SS
22697	7' x 10'	PL
22698	10' x 14'	PL
41261	7' x 10'	AL
41262	10' x 14'	AL



69290	14' x 20'	FB
85384	7' x 10'	SS
85385	10' x 14'	SS
22699	7' x 10'	PL
22700	10' x 14'	PL
41264	10' x 14'	AL



58763	10' x 14'	FB
58764	14' x 20'	FB
89087	7' x 10'	SS
89088	10' x 14'	SS
25418	7' x 10'	PL
25419	10' x 14'	PL
42995	7' x 10'	AL
42996	10' x 14'	AL



69291	14' x 20'	FB
85386	7' x 10'	SS
22701	7' x 10'	PL
41266	10' x 14'	AL



125900	7' x 10'	SS
125903	10' x 14'	SS
125899	7' x 10'	PL
125902	10' x 14'	PL
125898	7' x 10'	AL
125901	10' x 14'	AL



125906	7' x 10'	SS
125909	10' x 14'	SS
125905	7' x 10'	PL
125908	10' x 14'	PL
125904	7' x 10'	AL
125907	10' x 14'	AL



69775	10' x 14'	FB
22703	7' x 10'	PL
22704	10' x 14'	PL
41267	7' x 10'	AL
41268	10' x 14'	AL



125918	7' x 10'	SS
125921	10' x 14'	SS
125917	7' x 10'	PL
125920	10' x 14'	PL
125916	7' x 10'	AL
125919	10' x 14'	AL



43496	10' x 14'	AL
-------	-----------	----



125924	7' x 10'	SS
125927	10' x 14'	SS
125923	7' x 10'	PL
125926	10' x 14'	PL
125922	7' x 10'	AL
125925	10' x 14'	AL



125930	10' x 7'	SS
125933	14' x 10'	SS
125929	10' x 7'	PL
125932	14' x 10'	PL
125928	10' x 7'	AL
125931	14' x 10'	AL



125936	7' x 10'	SS
125939	10' x 14'	SS
125935	7' x 10'	PL
125938	10' x 14'	PL
125934	7' x 10'	AL
125937	10' x 14'	AL



76073	10' x 14'	FB
84289	7' x 10'	SS
40829	10' x 14'	AL



84291	7' x 10'	SS
84292	10' x 14'	SS
22266	7' x 10'	PL
22267	10' x 14'	PL
40831	10' x 14'	AL



43514	10' x 14'	AL
-------	-----------	----



84293	7' x 10'	SS
84294	10' x 14'	SS
22268	7' x 10'	PL
22269	10' x 14'	PL
40832	7' x 10'	AL
40833	10' x 14'	AL



125942	7' x 10'	SS
125945	10' x 14'	SS
125941	7' x 10'	PL
125944	10' x 14'	PL
125940	7' x 10'	AL
125943	10' x 14'	AL



125750	7' x 10'	SS
125753	10' x 14'	SS
125749	7' x 10'	PL
125752	10' x 14'	PL
125748	7' x 10'	AL
125751	10' x 14'	AL



70256	10' x 14'	FB
84295	7' x 10'	SS
84296	10' x 14'	SS
22270	7' x 10'	PL
40834	7' x 10'	AL



122838	7' x 10'	FB
47117	10' x 14'	FB
87766	3.5' x 5'	SS
84297	7' x 10'	SS
84298	10' x 14'	SS
22272	7' x 10'	PL
22273	10' x 14'	PL
40836	7' x 10'	AL
40837	10' x 14'	AL



125954	7' x 10'	SS
125957	10' x 14'	SS
125953	7' x 10'	PL
125956	10' x 14'	PL
125952	7' x 10'	AL
125955	10' x 14'	AL

Sign Selection Guide

- FB - Premium fiberglass (B-120)
- SS - Self-sticking polyester (B-302)
- PL - Plastic (B-401)
- AL - Aluminum (B-555)
- BGSS - BradyGlo™ self-stick polyester (B-324)
- BGPL - BradyGlo™ plastic (B-347)

Material Comparison page 408
Sign Legend Index..... page 588

Regulations

Appendix A to 1910.1450

Prominent signs of the following types should be posted:

- Emergency telephone numbers of emergency personnel/facilities, supervisors, and laboratory workers;
- Location signs for safety showers, eyewash stations, other safety and first aid equipment, and exits.
- Warnings at areas or equipment where special or unusual hazards exist.

Chemical and Hazardous Material Signs

BradyID.com/s36

Chemical and Hazardous Material Signs (continued)

					
125960 7" x 10" SS 125963 10" x 14" SS 125959 7" x 10" PL 125962 10" x 14" PL 125958 7" x 10" AL 125961 10" x 14" AL	125966 7" x 10" SS 125969 10" x 14" SS 125965 7" x 10" PL 125968 10" x 14" PL 125964 7" x 10" AL 125967 10" x 14" AL	69228 10" x 14" FB 84301 7" x 10" SS 84302 10" x 14" SS 22277 10" x 14" PL 40840 7" x 10" AL 40841 10" x 14" AL	125972 7" x 10" SS 125975 10" x 14" SS 125971 7" x 10" PL 125974 10" x 14" PL 125970 7" x 10" AL 125973 10" x 14" AL	125978 7" x 10" SS 125981 10" x 14" SS 125977 7" x 10" PL 125980 10" x 14" PL 125976 7" x 10" AL 125979 10" x 14" AL	124282 7" x 10" SS 124285 10" x 14" SS 124281 7" x 10" PL 124284 10" x 14" PL 124280 7" x 10" AL 124283 10" x 14" AL
					
126008 7" x 10" SS 126011 10" x 14" SS 126007 7" x 10" PL 126010 10" x 14" PL 126006 7" x 10" AL 126009 10" x 14" AL	125990 7" x 10" SS 125993 10" x 14" SS 125989 7" x 10" PL 125992 10" x 14" PL 125988 7" x 10" AL 125991 10" x 14" AL	126002 7" x 10" SS 126005 10" x 14" SS 126001 7" x 10" PL 126004 10" x 14" PL 126000 7" x 10" AL 126003 10" x 14" AL	125996 7" x 10" SS 125999 10" x 14" SS 125995 7" x 10" PL 125998 10" x 14" PL 125994 7" x 10" AL 125997 10" x 14" AL	122898 7" x 10" FB 122760 10" x 14" FB 69005 14" x 20" FB 85407 7" x 10" SS 85408 10" x 14" SS 22707 7" x 10" PL 22708 10" x 14" PL 41271 7" x 10" AL 41272 10" x 14" AL	122842 7" x 10" FB 70374 10" x 14" FB 85409 7" x 10" SS 85410 10" x 14" SS 22709 7" x 10" PL 22710 10" x 14" PL 41273 7" x 10" AL 41274 10" x 14" AL
					
85411 7" x 10" SS 85412 10" x 14" SS 22711 7" x 10" PL 22712 10" x 14" PL 41275 7" x 10" AL 41276 10" x 14" AL	126014 7" x 10" SS 126017 10" x 14" SS 126013 7" x 10" PL 126016 10" x 14" PL 126012 7" x 10" AL 126015 10" x 14" AL	85414 10" x 14" SS 22713 7" x 10" PL 22714 10" x 14" PL	126020 7" x 10" SS 126023 10" x 14" SS 126019 7" x 10" PL 126022 10" x 14" PL 126018 7" x 10" AL 126021 10" x 14" AL	126026 7" x 10" SS 126029 10" x 14" SS 126025 7" x 10" PL 126028 10" x 14" PL 126024 7" x 10" AL 126027 10" x 14" AL	126032 7" x 10" SS 126035 10" x 14" SS 126031 7" x 10" PL 126034 10" x 14" PL 126030 7" x 10" AL 126033 10" x 14" AL
					
69408 10" x 14" FB 84313 7" x 10" SS 84314 10" x 14" SS 22282 7" x 10" PL 22283 10" x 14" PL 40846 7" x 10" AL 40847 10" x 14" AL	84315 7" x 10" SS 84316 10" x 14" SS 85418 10" x 14" PL 22285 10" x 14" PL 40848 7" x 10" AL 40849 10" x 14" AL	126038 7" x 10" SS 126041 10" x 14" SS 126037 7" x 10" PL 126040 10" x 14" PL 126036 7" x 10" AL 126039 10" x 14" AL	72573 10" x 14" FB 84317 7" x 10" SS 84318 10" x 14" SS 22287 10" x 14" PL 40850 7" x 10" AL 40851 10" x 14" AL	126044 7" x 10" SS 126047 10" x 14" SS 126043 7" x 10" PL 126046 10" x 14" PL 126042 7" x 10" AL 126045 10" x 14" AL	84319 7" x 10" SS 84320 10" x 14" SS 22289 10" x 14" PL 40852 7" x 10" AL 40853 10" x 14" AL
					
126050 7" x 10" SS 126053 10" x 14" SS 126049 7" x 10" PL 126052 10" x 14" PL 126048 7" x 10" AL 126051 10" x 14" AL	73422 10" x 14" FB 85417 7" x 10" SS 85418 10" x 14" SS 22717 7" x 10" PL 22718 10" x 14" PL 41281 7" x 10" AL 41282 10" x 14" AL	126056 7" x 10" SS 126059 10" x 14" SS 126055 7" x 10" PL 126058 10" x 14" PL 126054 7" x 10" AL 126057 10" x 14" AL	70559 10" x 14" FB 84321 7" x 10" SS 84322 10" x 14" SS 22291 10" x 14" PL	126062 7" x 10" SS 126065 10" x 14" SS 126061 7" x 10" PL 126064 10" x 14" PL 126060 7" x 10" AL 126063 10" x 14" AL	126068 7" x 10" SS 126071 10" x 14" SS 126067 7" x 10" PL 126070 10" x 14" PL 126066 7" x 10" AL 126069 10" x 14" AL

Chemical and Hazardous Material Signs

BradyID.com/s36

Chemical and Hazardous Material Signs (continued)



126074	10" x 7"	SS
126077	14" x 10"	SS
126073	10" x 7"	PL
126076	14" x 10"	PL
126072	10" x 7"	AL
126075	14" x 10"	AL



126086	7" x 10"	SS
126089	10" x 14"	SS
126085	7" x 10"	PL
126088	10" x 14"	PL
126084	7" x 10"	AL
126087	10" x 14"	AL



126092	7" x 10"	SS
126095	10" x 14"	SS
126091	7" x 10"	PL
126094	10" x 14"	PL
126090	7" x 10"	AL
126093	10" x 14"	AL



43499	10" x 14"	AL
-------	-----------	----

Sign Selection Guide

- FB - Premium fiberglass (B-120)
- SS - Self-sticking polyester (B-302)
- PL - Plastic (B-401)
- AL - Aluminum (B-555)
- BGSS - BradyGlo™ self-stick polyester (B-324)
- BGPL - BradyGlo™ plastic (B-347)

Material Comparison page 408
Sign Legend Index..... page 588



126080	7" x 10"	SS
126083	10" x 14"	SS
126079	7" x 10"	PL
126082	10" x 14"	PL
126078	7" x 10"	AL
126081	10" x 14"	AL



70206	7" x 10"	FB
70207	10" x 14"	FB
84323	7" x 10"	SS
84324	10" x 14"	SS
22292	7" x 10"	PL
22293	10" x 14"	PL
40856	7" x 10"	AL
40857	10" x 14"	AL



122819	7" x 10"	FB
47206	10" x 14"	FB
84326	7" x 10"	SS
84327	10" x 14"	SS
122518	7" x 10"	PL
22295	10" x 14"	PL
40858	7" x 10"	AL
40859	10" x 14"	AL



70208	7" x 17"	FB
-------	----------	----



131825	7" x 10"	FB
131826	10" x 14"	FB
131823	7" x 10"	SS
131824	10" x 14"	SS
131821	7" x 10"	PL
131822	10" x 14"	PL
131819	7" x 10"	AL
131820	10" x 14"	AL



126110	7" x 10"	SS
126113	10" x 14"	SS
126109	7" x 10"	PL
126112	10" x 14"	PL
126108	7" x 10"	AL
126111	10" x 14"	AL



126116	7" x 10"	SS
126119	10" x 14"	SS
126115	7" x 10"	PL
126118	10" x 14"	PL
126114	7" x 10"	AL
126117	10" x 14"	AL



84332	7" x 10"	SS
84333	10" x 14"	SS
22296	7" x 10"	PL
22297	10" x 14"	PL
40860	7" x 10"	AL
40861	10" x 14"	AL



126104	7" x 10"	SS
126107	10" x 14"	SS
126103	7" x 10"	PL
126106	10" x 14"	PL
126102	7" x 10"	AL
126105	10" x 14"	AL



84334	7" x 10"	SS
84335	10" x 14"	SS
22298	7" x 10"	PL
25878	10" x 14"	PL
40862	7" x 10"	AL
43455	10" x 14"	AL



126122	7" x 10"	SS
126125	10" x 14"	SS
126121	7" x 10"	PL
126124	10" x 14"	PL
126120	7" x 10"	AL
126123	10" x 14"	AL



125822	7" x 10"	SS
125825	10" x 14"	SS
125821	7" x 10"	PL
125824	10" x 14"	PL
125820	7" x 10"	AL
125823	10" x 14"	AL



131861	7" x 10"	FB
131862	10" x 14"	FB
131859	7" x 10"	SS
84337	10" x 14"	SS
22299	7" x 10"	PL
22300	10" x 14"	PL
40863	7" x 10"	AL
40864	10" x 14"	AL



84338	7" x 10"	SS
84339	10" x 14"	SS
22301	7" x 10"	PL
22302	10" x 14"	PL
40865	7" x 10"	AL
40866	10" x 14"	AL



126194	7" x 10"	SS
126197	10" x 14"	SS
126193	7" x 10"	PL
126196	10" x 14"	PL
126192	7" x 10"	AL
126195	10" x 14"	AL



70217	10" x 14"	FB
84340	7" x 10"	SS
84341	10" x 14"	SS
22304	10" x 14"	PL
40867	7" x 10"	AL
40868	10" x 14"	AL

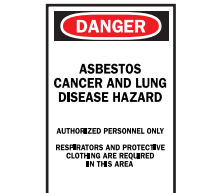

74520	20" x 14"	FB
85437	10" x 7"	SS
85438	14" x 10"	SS
22721	10" x 7"	PL
22722	14" x 10"	PL
41285	10" x 7"	AL
41286	14" x 10"	AL



123661	7" x 10"	SS
123664	10" x 14"	SS
123660	7" x 10"	PL
123663	10" x 14"	PL
123659	7" x 10"	AL
123662	10" x 14"	AL



125810	7" x 10"	SS
125813	10" x 14"	SS
125809	7" x 10"	PL
125812	10" x 14"	PL
125808	7" x 10"	AL
125811	10" x 14"	AL



75974	7" x 10"	FB
75975	10" x 14"	FB
85439	7" x 10"	SS
22723	7" x 10"	PL



85441	7" x 10"	SS
85442	10" x 14"	SS
69765	10" x 14"	FB
22725	7" x 10"	PL
22726	10" x 14"	PL



85443	7" x 10"	SS
85444	10" x 14"	SS
25777	10" x 14"	PL
43353	7" x 10"	AL
43354	10" x 14"	AL



125834	7" x 10"	SS
125837	10" x 14"	SS
125833	7" x 10"	PL
125836	10" x 14"	PL
125832	7" x 10"	AL
125835	10" x 14"	AL



23090	7" x 10"	PL
41990	7" x 10"	AL
41991	10" x 14"	AL

Safety Signs

Chemical and Hazardous Material Signs

BradyID.com/s36

Chemical and Hazardous Material Signs (continued)



126140 7' x 10' SS
126143 10' x 14' SS
126139 7' x 10' PL
126142 10' x 14' PL
126138 7' x 10' AL
126141 10' x 14' AL



126134 7' x 10' SS
126137 10' x 14' SS
126133 7' x 10' PL
126136 10' x 14' PL
126132 7' x 10' AL
126135 10' x 14' AL



72392 7' x 10' FB
73489 10' x 14' FB
84345 7' x 10' SS
84346 10' x 14' SS
22305 7' x 10' PL
22306 10' x 14' PL
40869 7' x 10' AL
40870 10' x 14' AL



126146 7' x 10' SS
126149 10' x 14' SS
126145 7' x 10' PL
126148 10' x 14' PL
126144 7' x 10' AL
126147 10' x 14' AL



22308 10' x 14' PL
40871 7' x 10' AL



126152 7' x 10' SS
126155 10' x 14' SS
126151 7' x 10' PL
126154 10' x 14' PL
126150 7' x 10' AL
126153 10' x 14' AL



84349 7' x 10' SS
84350 10' x 14' SS
22309 7' x 10' PL
22310 10' x 14' PL
40873 7' x 10' AL
40874 10' x 14' AL



122820 7' x 10' FB
70240 10' x 14' FB
84351 7' x 10' SS
84352 10' x 14' SS
22311 7' x 10' PL
22312 10' x 14' PL
122406 7' x 10' AL
40876 10' x 14' AL



131753 7' x 10' FB
131754 10' x 14' FB
131751 7' x 10' SS
131752 10' x 14' SS
131749 7' x 10' PL
131750 10' x 14' PL
131747 7' x 10' AL
131748 10' x 14' AL



84042 7' x 10' SS
84043 10' x 14' SS
22079 7' x 10' PL
22080 10' x 14' PL
40643 7' x 10' AL
40644 10' x 14' AL



131829 7' x 10' FB
72408 10' x 14' FB
84355 7' x 10' SS
84356 10' x 14' SS
22313 7' x 10' PL
22314 10' x 14' PL
40877 7' x 10' AL
40878 10' x 14' AL



84357 7' x 10' SS
84358 10' x 14' SS
22315 7' x 10' PL
22316 10' x 14' PL
40879 7' x 10' AL
40880 10' x 14' AL



125840 7' x 10' SS
125843 10' x 14' SS
125839 7' x 10' PL
125842 10' x 14' PL
125838 7' x 10' AL
125841 10' x 14' AL



126158 7' x 10' SS
126161 10' x 14' SS
126157 7' x 10' PL
126160 10' x 14' PL
126156 7' x 10' AL
126159 10' x 14' AL



122821 7' x 10' FB
70246 10' x 14' FB
84361 7' x 10' SS
84362 10' x 14' SS
22317 7' x 10' PL
22318 10' x 14' PL
40881 7' x 10' AL
40882 10' x 14' AL



131809 7' x 10' FB
131810 10' x 14' FB
131807 7' x 10' SS
131808 10' x 14' SS
131805 7' x 10' PL
131806 10' x 14' PL
131803 7' x 10' AL
131804 10' x 14' AL



126164 7' x 10' SS
126167 10' x 14' SS
126163 7' x 10' PL
126166 10' x 14' PL
126162 7' x 10' AL
126165 10' x 14' AL



126164 7' x 10' SS
126167 10' x 14' SS
126163 7' x 10' PL
126166 10' x 14' PL
126162 7' x 10' AL
126165 10' x 14' AL



125876 7' x 10' SS
125879 10' x 14' SS
125875 7' x 10' PL
125878 10' x 14' PL
125874 7' x 10' AL
125877 10' x 14' AL



69054 10' x 14' FB
84366 10' x 14' SS
22321 7' x 10' PL
22322 10' x 14' PL
40885 7' x 10' AL
40886 10' x 14' AL



122909 7' x 10' FB
122770 10' x 14' FB
85451 3.5' x 5' SS
85452 7' x 10' SS
85453 10' x 14' SS
122562 7' x 10' PL
122499 10' x 14' PL
122458 7' x 10' AL
122387 10' x 14' AL



125948 7' x 10' SS
125951 10' x 14' SS
125947 7' x 10' PL
125950 10' x 14' PL
125946 7' x 10' AL
125949 10' x 14' AL



126170 7' x 10' SS
126173 10' x 14' SS
126169 7' x 10' PL
126172 10' x 14' PL
126168 7' x 10' AL
126171 10' x 14' AL



126176 7' x 10' SS
126179 10' x 14' SS
126175 7' x 10' PL
126178 10' x 14' PL
126174 7' x 10' AL
126177 10' x 14' AL



122822 7' x 10' FB
70258 10' x 14' FB
122650 7' x 10' SS
84368 10' x 14' SS
22323 7' x 10' PL
22324 10' x 14' PL
40887 7' x 10' AL
40888 10' x 14' AL



69070 7' x 17' FB



84369 7' x 10' SS
84370 10' x 14' SS
25420 7' x 10' PL
42998 10' x 14' AL



70260 10' x 14' FB
84371 7' x 10' SS
84372 10' x 14' SS
25424 7' x 10' PL
25425 10' x 14' PL
43001 7' x 10' AL
43002 10' x 14' AL



125846 7' x 10' SS
125849 10' x 14' SS
125845 7' x 10' PL
125848 10' x 14' PL
125844 7' x 10' AL
125847 10' x 14' AL



72428 10' x 14' FB
22727 7' x 10' PL
22728 10' x 14' PL

Safety Signs

Chemical and Hazardous Material Signs

BradyID.com/s36

Chemical and Hazardous Material Signs (continued)



126188	7" x 10"	SS
126191	10" x 14"	SS
126187	7" x 10"	PL
126190	10" x 14"	PL
126186	7" x 10"	AL
126189	10" x 14"	AL



126182	7" x 10"	SS
126185	10" x 14"	SS
126181	7" x 10"	PL
126184	10" x 14"	PL
126180	7" x 10"	AL
126183	10" x 14"	AL



69089	10" x 14"	FB
85458	7" x 10"	SS
85459	10" x 14"	SS
22729	7" x 10"	PL
22730	10" x 14"	PL
41293	7" x 10"	AL
41294	10" x 14"	AL



122823	7" x 10"	FB
70267	14" x 20"	FB
87763	3.5" x 5"	SS
84375	7" x 10"	SS
84376	10" x 14"	SS
25428	7" x 10"	PL
25429	10" x 14"	PL
122407	7" x 10"	AL
43006	10" x 14"	AL

Sign Selection Guide

FB - Premium fiberglass (B-120)
 SS - Self-sticking polyester (B-302)
 PL - Plastic (B-401)
 AL - Aluminum (B-555)
 BGSS - BradyGlo™ self-stick polyester (B-324)
 BGPL - BradyGlo™ plastic (B-347)

Material Comparison page 408
 Sign Legend Index..... page 588



123631	7" x 10"	SS
123634	10" x 14"	SS
123630	7" x 10"	PL
123633	10" x 14"	PL
123629	7" x 10"	AL
123632	10" x 14"	AL



126212	7" x 10"	SS
126215	10" x 14"	SS
126211	7" x 10"	PL
126214	10" x 14"	PL
126210	7" x 10"	AL
126213	10" x 14"	AL



126200	7" x 10"	SS
126203	10" x 14"	SS
126199	7" x 10"	PL
126202	10" x 14"	PL
126198	7" x 10"	AL
126201	10" x 14"	AL



126206	7" x 10"	SS
126209	10" x 14"	SS
126205	7" x 10"	PL
126208	10" x 14"	PL
126204	7" x 10"	AL
126207	10" x 14"	AL



43507	10" x 14"	AL
-------	-----------	----



126218	10" x 7"	SS
126221	14" x 10"	SS
126217	10" x 7"	PL
126220	14" x 10"	PL
126216	10" x 7"	AL
126219	14" x 10"	AL



70327	10" x 14"	FB
72207	14" x 20"	FB
85161	7" x 10"	SS
85162	10" x 14"	SS
25650	7" x 10"	PL
25651	10" x 14"	PL
43228	10" x 14"	AL



70329	7" x 17"	FB
-------	----------	----



84379	7" x 10"	SS
25430	7" x 10"	PL
25431	10" x 14"	PL
43007	7" x 10"	AL
43008	10" x 14"	AL



73436	14" x 20"	FB
85165	7" x 10"	SS
85166	10" x 14"	SS
25652	7" x 10"	PL
25653	10" x 14"	PL
43230	10" x 14"	AL



75639	10" x 14"	FB
85167	7" x 10"	SS
85168	10" x 14"	SS
25654	7" x 10"	PL
25655	10" x 14"	PL
43231	7" x 10"	AL
43232	10" x 14"	AL



131777	7" x 10"	FB
131778	10" x 14"	FB
131775	7" x 10"	SS
131776	10" x 14"	SS
131773	7" x 10"	PL
131774	10" x 14"	PL
131771	7" x 10"	AL
131772	10" x 14"	AL



71895	14" x 20"	FB
85169	7" x 10"	SS
85170	10" x 14"	SS
25656	7" x 10"	PL
25657	10" x 14"	PL
43233	7" x 10"	AL



70350	7" x 17"	FB
25898	10" x 14"	PL
43475	10" x 14"	AL



122815	7" x 10"	FB
72230	10" x 14"	FB
87764	3.5" x 5"	SS
85175	7" x 10"	SS
85176	10" x 14"	SS
122517	7" x 10"	PL
25661	10" x 14"	PL
43237	7" x 10"	AL
43238	10" x 14"	AL



131801	7" x 10"	FB
131802	10" x 14"	FB
131799	7" x 10"	SS
131800	10" x 14"	SS
131797	7" x 10"	PL
131798	10" x 14"	PL
131795	7" x 10"	AL
131796	10" x 14"	AL



123709	7" x 10"	SS
123712	10" x 14"	SS
123708	7" x 10"	PL
123711	10" x 14"	PL
123707	7" x 10"	AL
123710	10" x 14"	AL



71932	10" x 14"	FB
85179	7" x 10"	SS
85180	10" x 14"	SS
25662	7" x 10"	PL
25663	10" x 14"	PL
43239	7" x 10"	AL
43240	10" x 14"	AL



72238	10" x 14"	FB
85181	7" x 10"	SS
85182	10" x 14"	SS
25665	10" x 14"	PL
43241	7" x 10"	AL
43242	10" x 14"	AL



123691	7" x 10"	SS
123694	10" x 14"	SS
123690	7" x 10"	PL
123693	10" x 14"	PL
123689	7" x 10"	AL
123692	10" x 14"	AL



47148	7" x 10"	FB
47024	10" x 14"	FB
75662	14" x 20"	FB
85185	7" x 10"	SS
85186	10" x 14"	SS
25668	7" x 10"	PL
25669	10" x 14"	PL
43245	7" x 10"	AL
43246	10" x 14"	AL



73412	10" x 14"	FB
88359	7" x 10"	SS
88360	10" x 14"	SS
25068	7" x 10"	PL
25069	10" x 14"	PL
42645	7" x 10"	AL
42646	10" x 14"	AL



122825	7" x 10"	FB
72246	10" x 14"	FB
87762	3.5" x 5"	SS
85183	7" x 10"	SS
85184	10" x 14"	SS
25666	7" x 10"	PL
25667	10" x 14"	PL
43243	7" x 10"	AL
43244	10" x 14"	AL



131793	7" x 10"	FB
131794	10" x 14"	FB
131791	7" x 10"	SS
131792	10" x 14"	SS
131789	7" x 10"	PL
131790	10" x 14"	PL
131787	7" x 10"	AL
131788	10" x 14"	AL

Safety Signs

Chemical and Hazardous Material Signs

BradyID.com/s36

Chemical and Hazardous Material Signs (continued)



71945	10" x 14"	FB
85187	7" x 10"	SS
85188	10" x 14"	SS
25670	7" x 10"	PL
25671	10" x 14"	PL
43247	7" x 10"	AL
43248	10" x 14"	AL



126224	10" x 7"	SS
126227	14" x 10"	SS
126223	10" x 7"	PL
126226	14" x 10"	PL
126222	10" x 7"	AL
126225	14" x 10"	AL



43508	10" x 14"	AL
-------	-----------	----



94996	7" x 10"	FB
95002	7" x 10"	SS
95003	10" x 14"	SS
95000	7" x 10"	PL
95001	10" x 14"	PL
94998	7" x 10"	AL
94999	10" x 14"	AL



76092	10" x 14"	FB
85485	7" x 10"	SS
85486	10" x 14"	SS
22741	7" x 10"	PL
22742	10" x 14"	PL
41305	7" x 10"	AL
41306	10" x 14"	AL



70357	10" x 14"	FB
84387	7" x 10"	SS
84388	10" x 14"	SS
25422	7" x 10"	PL
25423	10" x 14"	PL
42999	7" x 10"	AL
43000	10" x 14"	AL



126230	7" x 10"	SS
126233	10" x 14"	SS
126229	7" x 10"	PL
126232	10" x 14"	PL
126228	7" x 10"	AL
126231	10" x 14"	AL



69265	10" x 14"	FB
85489	7" x 10"	SS
85490	10" x 14"	SS
22745	7" x 10"	PL
22746	10" x 14"	PL
41310	10" x 14"	AL



69264	7" x 17"	FB
-------	----------	----



69275	10" x 14"	FB
84393	7" x 10"	SS
84394	10" x 14"	SS
25436	7" x 10"	PL
25437	10" x 14"	PL
43013	7" x 10"	AL
43014	10" x 14"	AL



72473	10" x 14"	FB
84395	7" x 10"	SS
84396	10" x 14"	SS
25438	7" x 10"	PL
25439	10" x 14"	PL
43015	7" x 10"	AL
43016	10" x 14"	AL



69000	10" x 14"	FB
85493	7" x 10"	SS
22749	7" x 10"	PL
22750	10" x 14"	PL
41313	7" x 10"	AL
41314	10" x 14"	AL



122826	7" x 10"	FB
70372	10" x 14"	FB
84397	7" x 10"	SS
84398	10" x 14"	SS
122519	7" x 10"	PL
25441	10" x 14"	PL
43017	7" x 10"	AL
43018	10" x 14"	AL



131769	7" x 10"	FB
131770	10" x 14"	FB
131767	7" x 10"	SS
131768	10" x 14"	SS
131765	7" x 10"	PL
131766	10" x 14"	PL
131763	7" x 10"	AL
131764	10" x 14"	AL



70373	10" x 14"	FB
84399	7" x 10"	SS
84400	10" x 14"	SS
25442	7" x 10"	PL
25443	10" x 14"	PL
43019	7" x 10"	AL
43020	10" x 14"	AL



126242	7" x 10"	SS
126245	10" x 14"	SS
126241	7" x 10"	PL
126244	10" x 14"	PL
126240	7" x 10"	AL
126243	10" x 14"	AL



85497	7" x 10"	SS
85498	10" x 14"	SS
22751	7" x 10"	PL
22752	10" x 14"	PL
41315	7" x 10"	AL
41316	10" x 14"	AL



85499	7" x 10"	SS
85500	10" x 14"	SS
22753	7" x 10"	PL
22754	10" x 14"	PL
41317	7" x 10"	AL
41318	10" x 14"	AL



126248	7" x 10"	SS
126251	10" x 14"	SS
126247	7" x 10"	PL
126250	10" x 14"	PL
126246	7" x 10"	AL
126249	10" x 14"	AL



131761	7" x 10"	FB
131762	10" x 14"	FB
131759	7" x 10"	SS
131760	10" x 14"	SS
131757	7" x 10"	PL
131758	10" x 14"	PL
131755	7" x 10"	AL
131756	10" x 14"	AL



70375	10" x 14"	FB
84080	7" x 10"	SS
84081	10" x 14"	SS
22101	7" x 10"	PL
22102	10" x 14"	PL
40665	7" x 10"	AL
40666	10" x 14"	AL



126236	10" x 7"	SS
126239	14" x 10"	SS
126241	7" x 10"	PL
126235	10" x 7"	PL
126238	14" x 10"	PL
126234	10" x 7"	AL
126237	14" x 10"	AL



126254	7" x 10"	SS
126257	10" x 14"	SS
126253	7" x 10"	PL
126256	10" x 14"	PL
126252	7" x 10"	AL
126255	10" x 14"	AL



126260	7" x 10"	SS
126263	10" x 14"	SS
126259	7" x 10"	PL
126262	10" x 14"	PL
126258	7" x 10"	AL
126261	10" x 14"	AL



126266	7" x 10"	SS
126269	10" x 14"	SS
126265	7" x 10"	PL
126268	10" x 14"	PL
126264	7" x 10"	AL
126267	10" x 14"	AL



72489	10" x 14"	FB
84403	7" x 10"	SS
25447	10" x 14"	PL
43023	7" x 10"	AL
43024	10" x 14"	AL



73484	14" x 20"	FB
85191	7" x 10"	SS
85192	10" x 14"	SS
25674	7" x 10"	PL
25675	10" x 14"	PL
43251	7" x 10"	AL



126272	7" x 10"	SS
126275	10" x 14"	SS
126271	7" x 10"	PL
126274	10" x 14"	PL
126270	7" x 10"	AL
126273	10" x 14"	AL



126278	7" x 10"	SS
126281	10" x 14"	SS
126277	7" x 10"	PL
126280	10" x 14"	PL
126276	7" x 10"	AL
126279	10" x 14"	AL

Safety Signs

Chemical and Hazardous Material Signs

BradyID.com/s36

Chemical and Hazardous Material Signs (continued)



125870	7" x 10"	SS
125873	10" x 14"	SS
125869	7" x 10"	PL
125872	10" x 14"	PL
125868	7" x 10"	AL
125871	10" x 14"	AL



125858	7" x 10"	SS
125861	10" x 14"	SS
125857	7" x 10"	PL
125860	10" x 14"	PL
125856	7" x 10"	AL
125859	10" x 14"	AL



125864	7" x 10"	SS
125867	10" x 14"	SS
125863	7" x 10"	PL
125866	10" x 14"	PL
125862	7" x 10"	AL
125865	10" x 14"	AL



72503	7" x 10"	FB
84407	7" x 10"	SS
84408	10" x 14"	SS
25448	7" x 10"	PL
25449	10" x 14"	PL
43026	10" x 14"	AL

Sign Selection Guide

- FB - Premium fiberglass (B-120)
- SS - Self-sticking polyester (B-302)
- PL - Plastic (B-401)
- AL - Aluminum (B-555)
- BGSS - BradyGlo™ self-stick polyester (B-324)
- BGPL - BradyGlo™ plastic (B-347)

Material Comparison page 408
Sign Legend Index..... page 588



131837	7" x 10"	FB
131838	10" x 14"	FB
131835	7" x 10"	SS
131836	10" x 14"	SS
131833	7" x 10"	PL
131834	10" x 14"	PL
131831	7" x 10"	AL
131832	10" x 14"	AL



84409	7" x 10"	SS
25450	7" x 10"	PL
25451	10" x 14"	PL
43027	7" x 10"	AL
43028	10" x 14"	AL



69294	10" x 14"	FB
84411	7" x 10"	SS
84412	10" x 14"	SS
25453	10" x 14"	PL
43029	7" x 10"	AL
43030	10" x 14"	AL



126284	7" x 10"	SS
126287	10" x 14"	SS
126283	7" x 10"	PL
126286	10" x 14"	PL
126282	7" x 10"	AL
126285	10" x 14"	AL



131845	7" x 10"	FB
131846	10" x 14"	FB
131843	7" x 10"	SS
131844	10" x 14"	SS
131841	7" x 10"	PL
131842	10" x 14"	PL
131839	7" x 10"	AL
131840	10" x 14"	AL



69304	7" x 17"	FB
-------	----------	----



43505	10" x 14"	AL
-------	-----------	----



69308	7" x 17"	FB
25910	10" x 14"	PL
43487	10" x 14"	AL



126296	7" x 10"	SS
126299	10" x 14"	SS
126295	7" x 10"	PL
126298	10" x 14"	PL
126294	7" x 10"	AL
126297	10" x 14"	AL



126302	7" x 10"	SS
126305	10" x 14"	SS
126301	7" x 10"	PL
126304	10" x 14"	PL
126300	7" x 10"	AL
126303	10" x 14"	AL



126290	7" x 10"	SS
126293	10" x 14"	SS
126289	7" x 10"	PL
126292	10" x 14"	PL
126288	7" x 10"	AL
126291	10" x 14"	AL



126308	7" x 10"	SS
126311	10" x 14"	SS
126307	7" x 10"	PL
126310	10" x 14"	PL
126306	7" x 10"	AL
126309	10" x 14"	AL



125828	7" x 10"	SS
125831	10" x 14"	SS
125827	7" x 10"	PL
125830	10" x 14"	PL
125826	7" x 10"	AL
125829	10" x 14"	AL



126314	7" x 10"	SS
126317	10" x 14"	SS
126313	7" x 10"	PL
126316	10" x 14"	PL
126312	7" x 10"	AL
126315	10" x 14"	AL



43510	10" x 14"	AL
-------	-----------	----



126320	7" x 10"	SS
126323	10" x 14"	SS
126319	7" x 10"	PL
126322	10" x 14"	PL
126318	7" x 10"	AL
126321	10" x 14"	AL



70419	10" x 14"	FB
84421	10" x 14"	SS
22326	10" x 14"	PL



69337	10" x 14"	FB
85512	7" x 10"	SS
22760	7" x 10"	PL
22761	10" x 14"	PL
41324	7" x 10"	AL
41325	10" x 14"	AL



70423	14" x 20"	FB
84422	7" x 10"	SS
84423	10" x 14"	SS
22327	7" x 10"	PL
22328	10" x 14"	PL
40891	7" x 10"	AL
40892	10" x 14"	AL



123667	7" x 10"	SS
123670	10" x 14"	SS
123666	7" x 10"	PL
123669	10" x 14"	PL
123665	7" x 10"	AL
123668	10" x 14"	AL



126326	7" x 10"	SS
126329	10" x 14"	SS
126325	7" x 10"	PL
126328	10" x 14"	PL
126324	7" x 10"	AL
126327	10" x 14"	AL



72537	10" x 14"	FB
84425	10" x 14"	SS
22329	7" x 10"	PL
22330	10" x 14"	PL



131853	7" x 10"	FB
131854	10" x 14"	FB
84426	7" x 10"	SS
84427	10" x 14"	SS
22331	7" x 10"	PL
22332	10" x 14"	PL
40895	7" x 10"	AL
40896	10" x 14"	AL



126338	7" x 10"	SS
126341	10" x 14"	SS
126337	7" x 10"	PL
126340	10" x 14"	PL
126336	7" x 10"	AL
126339	10" x 14"	AL

Safety Signs

Chemical and Hazardous Material Signs

Chemical and Hazardous Material Signs (continued)



126344	7" x 10"	SS
126347	10" x 14"	SS
126343	7" x 10"	PL
126346	10" x 14"	PL
126342	7" x 10"	AL
126345	10" x 14"	AL



69399	10" x 14"	FB
84428	7" x 10"	SS
84429	10" x 14"	SS
22333	7" x 10"	PL
22334	10" x 14"	PL
40897	7" x 10"	AL
40898	10" x 14"	AL



126350	7" x 10"	SS
126353	10" x 14"	SS
126349	7" x 10"	PL
126352	10" x 14"	PL
126348	7" x 10"	AL
126351	10" x 14"	AL



131745	7" x 10"	FB
131746	10" x 14"	FB
131743	7" x 10"	SS
131744	10" x 14"	SS
131741	7" x 10"	PL
131742	10" x 14"	PL
131739	7" x 10"	AL
131740	10" x 14"	AL



69409	7" x 17"	FB
-------	----------	----

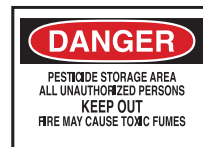

84430	7" x 10"	SS
84431	10" x 14"	SS
22335	7" x 10"	PL
22336	10" x 14"	PL
40899	7" x 10"	AL
40900	10" x 14"	AL



126356	7" x 10"	SS
126359	10" x 14"	SS
126355	7" x 10"	PL
126358	10" x 14"	PL
126354	7" x 10"	AL
126357	10" x 14"	AL



84434	3.5" x 5"	SS
84435	7" x 10"	SS
84436	10" x 14"	SS
22337	7" x 10"	PL
22338	10" x 14"	PL
40901	7" x 10"	AL
40902	10" x 14"	AL



126374	7" x 10"	SS
126377	10" x 14"	SS
126373	7" x 10"	PL
126376	10" x 14"	PL
126372	7" x 10"	AL
126375	10" x 14"	AL



126368	7" x 10"	SS
126371	10" x 14"	SS
126367	7" x 10"	PL
126370	10" x 14"	PL
126366	7" x 10"	AL
126369	10" x 14"	AL



40904	10" x 14"	AL
69440	10" x 14"	FB
84438	10" x 14"	SS
22339	7" x 10"	PL



126362	7" x 10"	SS
126365	10" x 14"	SS
126361	7" x 10"	PL
126364	10" x 14"	PL
126360	7" x 10"	AL
126363	10" x 14"	AL



126380	7" x 10"	SS
126383	10" x 14"	SS
126379	7" x 10"	PL
126382	10" x 14"	PL
126378	7" x 10"	AL
126381	10" x 14"	AL



131830	7" x 10"	FB
73420	10" x 14"	FB
84439	7" x 10"	SS
84440	10" x 14"	SS
22341	7" x 10"	PL
22342	10" x 14"	PL
40905	7" x 10"	AL
40906	10" x 14"	AL



126386	7" x 10"	SS
126389	10" x 14"	SS
126385	7" x 10"	PL
126388	10" x 14"	PL
126384	7" x 10"	AL
126387	10" x 14"	AL



126398	7" x 10"	SS
126401	10" x 14"	SS
126397	7" x 10"	PL
126400	10" x 14"	PL
126396	7" x 10"	AL
126399	10" x 14"	AL



123655	7" x 10"	SS
123658	10" x 14"	SS
123654	7" x 10"	PL
123657	10" x 14"	PL
123653	7" x 10"	AL
123656	10" x 14"	AL



72587	14" x 20"	FB
85521	7" x 10"	SS
85522	10" x 14"	SS
22764	7" x 10"	PL
22765	10" x 14"	PL
41328	7" x 10"	AL
41329	10" x 14"	AL



87647	7" x 10"	FB
87648	10" x 14"	FB
59397	7" x 10"	SS
50998	10" x 14"	SS
59395	7" x 10"	PL
16840	10" x 14"	PL
16841	10" x 14"	AL



84446	10" x 14"	SS
22343	7" x 10"	PL
40908	10" x 14"	AL



126098	7" x 10"	SS
126101	10" x 14"	SS
126097	7" x 10"	PL
126100	10" x 14"	PL
126096	7" x 10"	AL
126099	10" x 14"	AL



126404	7" x 10"	SS
126407	10" x 14"	SS
126403	7" x 10"	PL
126406	10" x 14"	PL
126402	7" x 10"	AL
126405	10" x 14"	AL



125852	7" x 10"	SS
125855	10" x 14"	SS
125851	7" x 10"	PL
125854	10" x 14"	PL
125850	7" x 10"	AL
125853	10" x 14"	AL



125816	7" x 10"	SS
125819	10" x 14"	SS
125815	7" x 10"	PL
125818	10" x 14"	PL
125814	7" x 10"	AL
125817	10" x 14"	AL



70582	10" x 14"	FB
88627	7" x 10"	SS
88628	10" x 14"	SS
25222	7" x 10"	PL
25223	10" x 14"	PL
42799	7" x 10"	AL
42800	10" x 14"	AL



84457	7" x 10"	SS
84458	10" x 14"	SS
22349	7" x 10"	PL
22350	10" x 14"	PL
40913	10" x 14"	AL
40914	10" x 14"	AL



70585	10" x 14"	FB
84459	7" x 10"	SS
22351	7" x 10"	PL



69558	10" x 14"	FB
84461	7" x 10"	SS
84462	10" x 14"	SS
22353	7" x 10"	PL
22354	10" x 14"	PL



126416	7" x 10"	SS
126419	10" x 14"	SS
126415	7" x 10"	PL
126418	10" x 14"	PL
126414	7" x 10"	AL
126417	10" x 14"	AL



126410	7" x 10"	SS
126413	10" x 14"	SS
126409	7" x 10"	PL
126412	10" x 14"	PL
126408	7" x 10"	AL
126411	10" x 14"	AL

Chemical and Hazardous Material Signs

BradyID.com/s36

Chemical and Hazardous Material Signs (continued)



84473	7" x 10"	SS
22365	7" x 10"	PL
22366	10" x 14"	PL



126428	7" x 10"	SS
126431	10" x 14"	SS
126427	7" x 10"	PL
126430	10" x 14"	PL
126426	7" x 10"	AL
126429	10" x 14"	AL



70239	10" x 14"	FB
85531	7" x 10"	SS
85532	10" x 14"	SS
22768	7" x 10"	PL
22769	10" x 14"	PL
41332	7" x 10"	AL
41333	10" x 14"	AL



126434	7" x 10"	SS
126437	10" x 14"	SS
126433	7" x 10"	PL
126436	10" x 14"	PL
126432	7" x 10"	AL
126435	10" x 14"	AL

Sign Selection Guide

- FB - Premium fiberglass (B-120)
- SS - Self-sticking polyester (B-302)
- PL - Plastic (B-401)
- AL - Aluminum (B-555)
- BGSS - BradyGlo™ self-stick polyester (B-324)
- BGPL - BradyGlo™ plastic (B-347)

Material Comparison page 408
Sign Legend Index..... page 588



85533	7" x 10"	SS
85534	10" x 14"	SS
22770	7" x 10"	PL
22771	10" x 14"	PL
41334	7" x 10"	AL
41335	10" x 14"	AL



70270	10" x 14"	FB
84463	7" x 10"	SS
84464	10" x 14"	SS
22355	7" x 10"	PL
22356	10" x 14"	PL
40920	10" x 14"	AL



85535	7" x 10"	SS
85536	10" x 14"	SS
25734	7" x 10"	PL
25735	10" x 14"	PL
43311	7" x 10"	AL
43312	10" x 14"	AL



126440	7" x 10"	SS
126443	10" x 14"	SS
126439	7" x 10"	PL
126442	10" x 14"	PL
126438	7" x 10"	AL
126441	10" x 14"	AL



126452	7" x 10"	SS
126455	10" x 14"	SS
126451	7" x 10"	PL
126454	10" x 14"	PL
126450	7" x 10"	AL
126453	10" x 14"	AL



126446	7" x 10"	SS
126449	10" x 14"	SS
126445	7" x 10"	PL
126448	10" x 14"	PL
126444	7" x 10"	AL
126447	10" x 14"	AL



131885	7" x 10"	FB
131886	10" x 14"	FB
131883	7" x 10"	SS
131884	10" x 14"	SS
131881	7" x 10"	PL
131882	10" x 14"	PL
131879	7" x 10"	AL
131880	10" x 14"	AL



126458	7" x 10"	SS
126461	10" x 14"	SS
126457	7" x 10"	PL
126460	10" x 14"	PL
126456	7" x 10"	AL
126459	10" x 14"	AL



126470	7" x 10"	SS
126473	10" x 14"	SS
126469	7" x 10"	PL
126472	10" x 14"	PL
126468	7" x 10"	AL
126471	10" x 14"	AL



126464	7" x 10"	SS
126467	10" x 14"	SS
126463	7" x 10"	PL
126466	10" x 14"	PL
126462	7" x 10"	AL
126465	10" x 14"	AL



70430	10" x 14"	FB
84466	10" x 14"	SS
22357	7" x 10"	PL
22358	10" x 14"	PL
40922	10" x 14"	AL



126476	7" x 10"	SS
126479	10" x 14"	SS
126475	7" x 10"	PL
126478	10" x 14"	PL
126474	7" x 10"	AL
126477	10" x 14"	AL



69407	10" x 14"	FB
84467	7" x 10"	SS
84468	10" x 14"	SS
22359	7" x 10"	PL
22360	10" x 14"	PL
40923	7" x 10"	AL
40924	10" x 14"	AL



95277	7" x 17"	FB
-------	----------	----



72546	7" x 10"	FB
84471	7" x 10"	SS
84472	10" x 14"	SS
22363	7" x 10"	PL
22364	10" x 14"	PL
40927	7" x 10"	AL
40928	10" x 14"	AL



84469	7" x 10"	SS
22361	7" x 10"	PL
22362	10" x 14"	PL
40925	7" x 10"	AL
40926	10" x 14"	AL



126482	7" x 10"	SS
126485	10" x 14"	SS
126481	7" x 10"	PL
126484	10" x 14"	PL
126480	7" x 10"	AL
126483	10" x 14"	AL



126488	7" x 10"	SS
126491	10" x 14"	SS
126487	7" x 10"	PL
126490	10" x 14"	PL
126486	7" x 10"	AL
126489	10" x 14"	AL



73418	10" x 14"	FB
88455	7" x 10"	SS
88456	10" x 14"	SS
25138	7" x 10"	PL
42715	7" x 10"	AL



74616	14" x 20"	FB
84476	10" x 14"	SS
22367	7" x 10"	PL
22368	10" x 14"	PL



74464	14" x 20"	FB
84477	7" x 10"	SS
84478	10" x 14"	SS
22369	7" x 10"	PL
40933	7" x 10"	AL
40934	10" x 14"	AL



126500	7" x 10"	SS
126503	10" x 14"	SS
126499	7" x 10"	PL
126502	10" x 14"	PL
126498	7" x 10"	AL
126501	10" x 14"	AL



126512	7" x 10"	SS
126515	10" x 14"	SS
126511	7" x 10"	PL
126514	10" x 14"	PL
126510	7" x 10"	AL
126513	10" x 14"	AL



126608	7" x 10"	SS
126611	10" x 14"	SS
126607	7" x 10"	PL
126610	10" x 14"	PL
126606	7" x 10"	AL
126609	10" x 14"	AL

Safety Signs

Chemical and Hazardous Material Signs

BradyID.com/s36

Chemical and Hazardous Material Signs (continued)



126518	7" x 10"	SS
126521	10" x 14"	SS
126517	7" x 10"	PL
126520	10" x 14"	PL
126516	7" x 10"	AL
126519	10" x 14"	AL



126524	7" x 10"	SS
126527	10" x 14"	SS
126523	7" x 10"	PL
126526	10" x 14"	PL
126522	7" x 10"	AL
126525	10" x 14"	AL



126530	7" x 10"	SS
126533	10" x 14"	SS
126529	7" x 10"	PL
126532	10" x 14"	PL
126528	7" x 10"	AL
126531	10" x 14"	AL



126542	7" x 10"	SS
126545	10" x 14"	SS
126541	7" x 10"	PL
126544	10" x 14"	PL
126540	7" x 10"	AL
126543	10" x 14"	AL



126560	7" x 10"	SS
126563	10" x 14"	SS
126559	7" x 10"	PL
126562	10" x 14"	PL
126558	7" x 10"	AL
126561	10" x 14"	AL



69585	10" x 14"	FB
85547	7" x 10"	SS
85548	10" x 14"	SS
25738	7" x 10"	PL
25739	10" x 14"	PL
43315	7" x 10"	AL
43316	10" x 14"	AL



69573	10" x 14"	FB
84483	7" x 10"	SS
84484	10" x 14"	SS
22371	7" x 10"	PL
22372	10" x 14"	PL
40935	7" x 10"	AL
40936	10" x 14"	AL



126548	7" x 10"	SS
126551	10" x 14"	SS
126547	7" x 10"	PL
126550	10" x 14"	PL
126546	7" x 10"	AL
126549	10" x 14"	AL



126554	7" x 10"	SS
126557	10" x 14"	SS
126553	7" x 10"	PL
126556	10" x 14"	PL
126552	7" x 10"	AL
126555	10" x 14"	AL



126566	7" x 10"	SS
126569	10" x 14"	SS
126568	10" x 14"	PL
126564	7" x 10"	AL
126567	10" x 14"	AL



126614	7" x 10"	SS
126617	10" x 14"	SS
126613	7" x 10"	PL
126616	10" x 14"	PL
126612	7" x 10"	AL
126615	10" x 14"	AL



126572	7" x 10"	SS
126575	10" x 14"	SS
126571	7" x 10"	PL
126574	10" x 14"	PL
126570	7" x 10"	AL
126573	10" x 14"	AL



126578	7" x 10"	SS
126581	10" x 14"	SS
126577	7" x 10"	PL
126580	10" x 14"	PL
126576	7" x 10"	AL
126579	10" x 14"	AL



126584	7" x 10"	SS
126587	10" x 14"	SS
126583	7" x 10"	PL
126586	10" x 14"	PL
126582	7" x 10"	AL
126585	10" x 14"	AL



122895	7" x 10"	FB
76085	10" x 14"	FB
87767	3.5" x 5"	SS
85549	7" x 10"	SS
85550	10" x 14"	SS
25740	7" x 10"	PL
25741	10" x 14"	PL
43317	7" x 10"	AL
43318	10" x 14"	AL



126590	7" x 10"	SS
126593	10" x 14"	SS
126589	7" x 10"	PL
126592	10" x 14"	PL
126588	7" x 10"	AL
126591	10" x 14"	AL



126596	7" x 10"	SS
126599	10" x 14"	SS
126595	7" x 10"	PL
126598	10" x 14"	PL
126594	7" x 10"	AL
126597	10" x 14"	AL



69604	10" x 14"	FB
84487	7" x 10"	SS
84488	10" x 14"	SS
22373	7" x 10"	PL
22374	10" x 14"	PL
40937	7" x 10"	AL
40938	10" x 14"	AL



69615	10" x 14"	FB
84491	7" x 10"	SS
84492	10" x 14"	SS
22377	7" x 10"	PL
22378	10" x 14"	PL
40942	10" x 14"	AL



126620	10" x 7"	SS
126623	14" x 10"	SS
126619	10" x 7"	PL
126622	14" x 10"	PL
126618	10" x 7"	AL
126621	14" x 10"	AL



125567	7" x 10"	SS
125570	10" x 14"	SS
125566	7" x 10"	PL
125569	10" x 14"	PL
125565	7" x 10"	AL
125568	10" x 14"	AL



125561	7" x 10"	SS
125564	10" x 14"	SS
125560	7" x 10"	PL
125563	10" x 14"	PL
125559	7" x 10"	AL
125562	10" x 14"	AL



125573	7" x 10"	SS
125576	10" x 14"	SS
125572	7" x 10"	PL
125575	10" x 14"	PL
125571	7" x 10"	AL
125574	10" x 14"	AL



84493	7" x 10"	SS
84494	10" x 14"	SS
40943	7" x 10"	AL



125579	7" x 10"	SS
125582	10" x 14"	SS
125578	7" x 10"	PL
125581	10" x 14"	PL
125577	7" x 10"	AL
125580	10" x 14"	AL



17942	7" x 10"	SS
-------	----------	----



125585	7" x 10"	SS
125588	10" x 14"	SS
125584	7" x 10"	PL
125587	10" x 14"	PL
125583	7" x 10"	AL
125586	10" x 14"	AL



17943	7" x 10"	SS
-------	----------	----



125591	7" x 10"	SS
125594	10" x 14"	SS
125590	7" x 10"	PL
125593	10" x 14"	PL
125589	7" x 10"	AL
125592	10" x 14"	AL

Safety Signs

Chemical and Hazardous Material Signs

BradyID.com/s36

Chemical and Hazardous Material Signs (continued)



125597	7" x 10"	SS
125600	10" x 14"	SS
125596	7" x 10"	PL
125599	10" x 14"	PL
125595	7" x 10"	AL
125598	10" x 14"	AL



17944	7" x 10"	SS
-------	----------	----



125603	7" x 10"	SS
125606	10" x 14"	SS
125602	7" x 10"	PL
125605	10" x 14"	PL
59404	7" x 10"	AL
125604	10" x 14"	AL



17945	7" x 10"	SS
-------	----------	----

Sign Selection Guide

- FB - Premium fiberglass (B-120)
- SS - Self-sticking polyester (B-302)
- PL - Plastic (B-401)
- AL - Aluminum (B-555)
- BGSS - BradyGlo™ self-stick polyester (B-324)
- BGPL - BradyGlo™ plastic (B-347)

Material Comparison page 408
Sign Legend Index..... page 588



25883	10" x 14"	PL
-------	-----------	----



125705	7" x 17"	SS
125704	7" x 17"	PL
125703	7" x 17"	AL



84497	7" x 10"	SS
84498	10" x 14"	SS
22380	7" x 10"	PL
22381	10" x 14"	PL



125615	7" x 10"	SS
125618	10" x 14"	SS
125614	7" x 10"	PL
125617	10" x 14"	PL
125613	7" x 10"	AL
125616	10" x 14"	AL



125621	7" x 10"	SS
125624	10" x 14"	SS
125620	7" x 10"	PL
125623	10" x 14"	PL
125619	7" x 10"	AL
125622	10" x 14"	AL



69794	7" x 7"	FB
88491	7" x 7"	SS
25157	7" x 10"	PL
42734	7" x 10"	AL

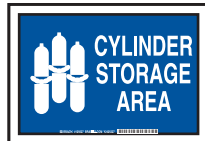

125627	7" x 10"	SS
125630	10" x 14"	SS
125626	7" x 10"	PL
125629	10" x 14"	PL
125625	7" x 10"	AL
125628	10" x 14"	AL

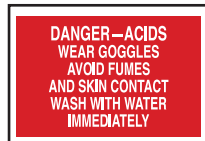

73490	10" x 14"	FB
85562	7" x 10"	SS
85563	10" x 14"	SS



60563	7" x 10"	SS
60533	7" x 10"	PL
60504	7" x 10"	AL



96090	7" x 10"	SS
60349	10" x 14"	SS
60348	10" x 14"	PL
96087	10" x 14"	AL



125633	7" x 10"	SS
125636	10" x 14"	SS
125632	7" x 10"	PL
125635	10" x 14"	PL
125631	7" x 10"	AL
125634	10" x 14"	AL



95010	7" x 10"	SS
95011	10" x 14"	SS
95008	7" x 10"	PL
95009	10" x 14"	PL
95006	7" x 10"	AL
95007	10" x 14"	AL



125639	7" x 10"	SS
125642	10" x 14"	SS
125638	7" x 10"	PL
125641	10" x 14"	PL
125637	7" x 10"	AL
125640	10" x 14"	AL



17955	7" x 10"	SS
-------	----------	----



125663	7" x 10"	SS
125666	10" x 14"	SS
125662	7" x 10"	PL
125665	10" x 14"	PL
125661	7" x 10"	AL
125664	10" x 14"	AL



125669	7" x 10"	SS
125672	10" x 14"	SS
125668	7" x 10"	PL
125671	10" x 14"	PL
125667	7" x 10"	AL
125670	10" x 14"	AL



70317	10" x 14"	FB
85564	7" x 10"	SS
85565	10" x 14"	SS
25745	7" x 10"	PL
43322	7" x 10"	AL



131901	7" x 10"	FB
131902	10" x 14"	FB
131899	7" x 10"	SS
131900	10" x 14"	SS
131897	7" x 10"	PL
131898	10" x 14"	PL
131895	7" x 10"	AL
131896	10" x 14"	AL



17956	7" x 10"	SS
-------	----------	----



125651	7" x 10"	SS
125654	10" x 14"	SS
125650	7" x 10"	PL
125653	10" x 14"	PL
125649	7" x 10"	AL
125652	10" x 14"	AL



125645	7" x 10"	SS
125648	10" x 14"	SS
125644	7" x 10"	PL
125647	10" x 14"	PL
125643	7" x 10"	AL
125646	10" x 14"	AL



125657	7" x 10"	SS
125660	10" x 14"	SS
125656	7" x 10"	PL
125659	10" x 14"	PL
125655	7" x 10"	AL
125658	10" x 14"	AL



69221	10" x 10"	FB
88500	10" x 10"	SS
25165	10" x 14"	PL



69252	10" x 10"	FB
88506	10" x 10"	SS
42748	10" x 14"	AL

Safety Signs

Chemical and Hazardous Material Signs

BradyID.com/s36

Chemical and Hazardous Material Signs (continued)



69442 10" x 10" FB
88522 10" x 10" SS



90710 10" x 7" BGPL



17952 7" x 10" SS



125681 7" x 10" SS
125684 10" x 14" SS
125680 7" x 10" PL
125683 10" x 14" PL
125679 7" x 10" AL
125682 10" x 14" AL



125675 7" x 10" SS
125678 10" x 14" SS
125674 7" x 10" PL
125677 10" x 14" PL
125673 7" x 10" AL
125676 10" x 14" AL



70356 10" x 14" FB
85566 7" x 10" SS
85567 10" x 14" SS
25746 7" x 10" PL
43323 7" x 10" AL



131893 7" x 10" FB
131894 10" x 14" FB
131891 7" x 10" SS
131892 10" x 14" SS
131889 7" x 10" PL
131890 10" x 14" PL
131887 7" x 10" AL
131888 10" x 14" AL



17953 7" x 10" SS



125693 7" x 10" SS
125696 10" x 14" SS
125692 7" x 10" PL
125695 10" x 14" PL
125691 7" x 10" AL
125694 10" x 14" AL



125699 7" x 10" SS
125702 10" x 14" SS
125698 7" x 10" PL
125701 10" x 14" PL
125697 7" x 10" AL
125700 10" x 14" AL



125687 7" x 10" SS
125690 10" x 14" SS
125686 7" x 10" PL
125689 10" x 14" PL
125685 7" x 10" AL
125688 10" x 14" AL



84507 7" x 10" SS
84508 10" x 14" SS
22385 7" x 10" PL
40949 7" x 10" AL



60568 7" x 10" SS



30673 7" x 10" SS
30670 10" x 14" AL

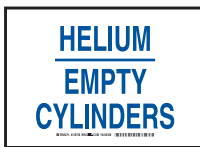

125708 7" x 10" SS
125711 10" x 14" SS
125707 7" x 10" PL
125710 10" x 14" PL
125706 7" x 10" AL
125709 10" x 14" AL



17946 7" x 10" SS



125714 7" x 10" SS
125717 10" x 14" SS
125713 7" x 10" PL
125716 10" x 14" PL
125712 7" x 10" AL
125715 10" x 14" AL



17947 7" x 10" SS



125720 7" x 10" SS
125723 10" x 14" SS
125719 7" x 10" PL
125722 10" x 14" PL
125718 7" x 10" AL
125721 10" x 14" AL

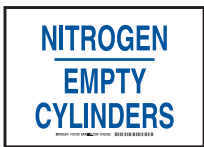

125726 7" x 10" SS
125729 10" x 14" SS
125725 7" x 10" PL
125728 10" x 14" PL
125724 7" x 10" AL
125727 10" x 14" AL



17948 7" x 10" SS



125732 7" x 10" SS
125735 10" x 14" SS
125731 7" x 10" PL
125734 10" x 14" PL
125730 7" x 10" AL
125733 10" x 14" AL



17949 7" x 10" SS



125738 7" x 10" SS
125741 10" x 14" SS
125737 7" x 10" PL
125740 10" x 14" PL
125736 7" x 10" AL
125739 10" x 14" AL



125744 7" x 10" SS
125747 10" x 14" SS
125743 7" x 10" PL
125746 10" x 14" PL
125742 7" x 10" AL
125745 10" x 14" AL



17954 7" x 10" SS



125555 7" x 10" SS
125558 10" x 14" SS
125554 7" x 10" PL
125557 10" x 14" PL
125553 7" x 10" AL
125556 10" x 14" AL



17950 7" x 10" SS Vinyl



17951 7" x 10" SS



125882 7" x 10" SS
125885 10" x 14" SS
125881 7" x 10" PL
125884 10" x 14" PL
125880 7" x 10" AL
125883 10" x 14" AL

Safety Signs

Chemical and Hazardous Material Signs

BradyID.com/s36

Chemical and Hazardous Material Signs (continued)



125756	7" x 10"	SS
125759	10" x 14"	SS
125755	7" x 10"	PL
125758	10" x 14"	PL
125754	7" x 10"	AL
125757	10" x 14"	AL



125774	10" x 7"	SS
125777	14" x 10"	SS
125773	10" x 7"	PL
125776	14" x 10"	PL
125772	10" x 7"	AL
125775	14" x 10"	AL



30672	7" x 10"	SS
30669	10" x 14"	AL



123859	7" x 10"	SS
123862	10" x 14"	SS
123858	7" x 10"	PL
123861	10" x 14"	PL
123857	7" x 10"	AL
123860	10" x 14"	AL

Sign Selection Guide

- FB - Premium fiberglass (B-120)
- SS - Self-sticking polyester (B-302)
- PL - Plastic (B-401)
- AL - Aluminum (B-555)
- BGSS - BradyGlo™ self-stick polyester (B-324)
- BGPL - BradyGlo™ plastic (B-347)

Material Comparison page 408
Sign Legend Index..... page 588



43979	7" x 10"	SS
-------	----------	----



125762	7" x 10"	SS
125765	10" x 14"	SS
125761	7" x 10"	PL
125764	10" x 14"	PL
125760	7" x 10"	AL
125763	10" x 14"	AL



30674	7" x 10"	SS
30671	10" x 14"	AL



43502	10" x 14"	AL
-------	-----------	----



69801	7" x 7"	FB
88529	7" x 7"	SS
25190	7" x 10"	PL
42767	7" x 10"	AL



122890	7" x 10"	FB
122750	10" x 14"	FB
43983	7" x 10"	SS
122608	10" x 14"	SS
122554	7" x 10"	PL
122489	10" x 14"	PL
60350	10" x 14"	AL



125768	7" x 10"	SS
125771	10" x 14"	SS
125767	7" x 10"	PL
125770	10" x 14"	PL
125766	7" x 10"	AL
125769	10" x 14"	AL



125780	7" x 10"	SS
125783	10" x 14"	SS
125779	7" x 10"	PL
125782	10" x 14"	PL
125778	7" x 10"	AL
125781	10" x 14"	AL



84511	7" x 10"	SS
22386	7" x 10"	PL



125798	7" x 10"	SS
125801	10" x 14"	SS
125797	7" x 10"	PL
125800	10" x 14"	PL
125796	7" x 10"	AL
125799	10" x 14"	AL



125792	7" x 10"	SS
125795	10" x 14"	SS
125791	7" x 10"	PL
125794	10" x 14"	PL
125790	7" x 10"	AL
125793	10" x 14"	AL



125804	7" x 10"	SS
125807	10" x 14"	SS
125803	7" x 10"	PL
125806	10" x 14"	PL
125802	7" x 10"	AL
125805	10" x 14"	AL

Safety Signs

Carbon Dioxide Signs

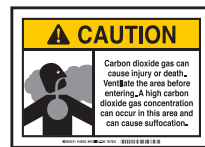

106053	7" x 10"	FB
106054	10" x 14"	FB
106047	3.5" x 5"	SS
106048	7" x 10"	SS
106049	7" x 10"	PL
106050	10" x 14"	PL
106051	7" x 10"	AL
106052	10" x 14"	AL

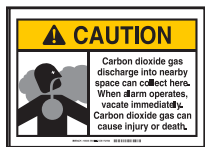

106045	7" x 10"	FB
106046	10" x 14"	FB
106039	3.5" x 5"	SS
106040	7" x 10"	SS
106041	7" x 10"	PL
106042	10" x 14"	PL
106043	7" x 10"	AL
106044	10" x 14"	AL

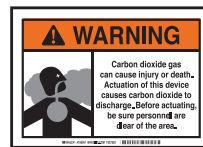

106061	7" x 10"	FB
106062	10" x 14"	FB
106055	3.5" x 5"	SS
106056	7" x 10"	SS
106057	7" x 10"	PL
106058	10" x 14"	PL
106059	7" x 10"	AL
106060	10" x 14"	AL

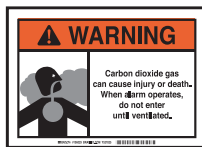

106029	7" x 10"	FB
106030	10" x 14"	FB
106023	3.5" x 5"	SS
106024	7" x 10"	SS
106025	7" x 10"	PL
106026	10" x 14"	PL
106027	7" x 10"	AL
106028	10" x 14"	AL

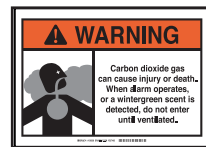

106037	7" x 10"	FB
106038	10" x 14"	FB
106031	3.5" x 5"	SS
106032	7" x 10"	SS
106033	7" x 10"	PL
106034	10" x 14"	PL
106035	7" x 10"	AL
106036	10" x 14"	AL



106021	7" x 10"	FB
106022	10" x 14"	FB
106015	3.5" x 5"	SS
106016	7" x 10"	SS
106017	7" x 10"	PL
106018	10" x 14"	PL
106019	7" x 10"	AL
106020	10" x 14"	AL

Chemical and Hazardous Material Signs

California Proposition 65 Signs

Proposition 65, officially known as the Safe Drinking Water and Toxic Enforcement Act of 1986, requires businesses to provide warnings to Californians about significant exposures to chemicals known to the state of California to cause cancer, birth defects or other reproductive harm.

CALIFORNIA PROPOSITION 65 WARNING
Diesel engine exhaust and some of its constituents are known to the State of California to cause cancer, birth defects, and other reproductive harm.

125609	7" x 10"	SS
125612	10" x 14"	SS
125608	7" x 10"	PL
125611	10" x 14"	PL
125607	7" x 10"	AL
125610	10" x 14"	AL

WARNING
Breathing the air in this parking garage can expose you to chemicals including carbon monoxide and gasoline or diesel engine exhaust, which are known to the State of California to cause cancer and birth defects or other reproductive harm. Do not stay in this area longer than necessary.

150457	10" x 7"	SS
150473	14" x 10"	SS
150447	14" x 10"	PL
150472	10" x 7"	AL
150446	14" x 10"	AL

WARNING
Crude oil, gasoline, diesel fuel and other petroleum products can expose you to chemicals including toluene and benzene, which are known to the State of California to cause cancer and birth defects or other reproductive harm. These exposures can occur in and around oil fields, refineries, chemical plants, transport and storage operations such as pipelines, marine terminals, tank trucks and other facilities and equipment.

150467	10" x 7"	SS
150475	14" x 10"	SS
150459	10" x 7"	PL
150476	14" x 10"	PL
150474	10" x 7"	AL
150458	14" x 10"	AL

WARNING
Breathing the air in this smoking area can expose you to chemicals including tobacco smoke and nicotine, which are known to the State of California to cause cancer and birth defects or other reproductive harm. Do not stay in this area longer than necessary.

150462	10" x 7"	SS
150465	14" x 10"	SS
150466	10" x 7"	PL
150445	14" x 10"	PL
150482	10" x 7"	AL
150456	14" x 10"	AL

WARNING
Certain dental procedures performed in this office can expose you to chemicals known to the State of California to cause cancer or birth defects or other reproductive harm or both. These procedures can include sedation with nitrous oxide, root canals, placement or removal of crowns, bridges, and restorations such as mercury-containing fillings and use of dental appliances.

150479	10" x 7"	SS
150468	14" x 10"	SS
150469	10" x 7"	PL
150454	14" x 10"	PL
150464	10" x 7"	AL
150451	14" x 10"	AL

WARNING
Certain foods and beverages sold or served here can expose you to chemicals including acrylamide in many fried or baked foods, and mercury in fish, which are known to the State of California to cause cancer and birth defects or other reproductive harm.

150481	10" x 7"	SS
150455	14" x 10"	SS
150441	10" x 7"	PL
150440	14" x 10"	PL
150461	10" x 7"	AL
150480	14" x 10"	AL

WARNING
Detectable Amounts Of Chemicals Known To The State Of California To Cause Cancer, Birth Defects Or Other Reproductive Harm May Be Found In This Facility

18151	10" x 14"	SS
18153	10" x 14"	PL
18152	10" x 14"	PL
18154	10" x 14"	AL

WARNING
Detectable amounts of chemicals known to the state of California to cause cancer, birth defects or other reproductive harm may be found in this facility.

144955	7" x 10"	SS
144956	10" x 14"	SS
144957	7" x 10"	PL
144958	10" x 14"	PL
144959	7" x 10"	AL
144960	10" x 14"	AL

WARNING
DETECTABLE AMOUNTS OF CHEMICALS KNOWN TO THE STATE OF CALIFORNIA TO CAUSE CANCER, BIRTH DEFECTS OR OTHER REPRODUCTIVE HARM MAY BE FOUND IN THIS FACILITY

126536	7" x 10"	SS
126539	10" x 14"	SS
126535	7" x 10"	PL
126538	10" x 14"	PL
126534	7" x 10"	AL
126537	10" x 14"	AL

WARNING
DETECTABLE AMOUNTS OF CHEMICALS KNOWN TO THE STATE OF CALIFORNIA TO CAUSE CANCER, BIRTH DEFECTS, OR OTHER REPRODUCTIVE HARM MAY BE FOUND IN AND AROUND THIS FACILITY.

125786	7" x 10"	SS
125789	10" x 14"	SS
125785	7" x 10"	PL
125788	10" x 14"	PL
125784	7" x 10"	AL
125787	10" x 14"	AL

WARNING
DETECTABLE AMOUNTS OF CHEMICALS KNOWN TO THE STATE OF CALIFORNIA TO CAUSE CANCER, BIRTH DEFECTS, OR OTHER REPRODUCTIVE HARM MAY BE FOUND IN AND AROUND THIS FACILITY.

122798	7" x 10"	FB
58621	10" x 14"	FB
89015	5" x 6"	SS
122637	7" x 10"	SS
89097	10" x 14"	SS
122505	7" x 10"	PL
122469	10" x 14"	PL
122394	7" x 10"	AL
122343	10" x 14"	AL

WARNING
DETECTABLE AMOUNTS OF CHEMICALS OR SUBSTANCES KNOWN TO THE STATE OF CALIFORNIA TO CAUSE CANCER, BIRTH DEFECTS, OR OTHER REPRODUCTIVE HARM MAY BE FOUND IN CHEMICAL PRODUCTS, PETROLEUM PRODUCTS, PAINT AND FINISH MATERIALS. FOLLOW ALL APPLICABLE DIRECTIONS AND USE CARE WHEN HANDLING CHEMICAL, PETROLEUM AND FINISH PRODUCTS.

18191	10" x 14"	FB
18187	10" x 14"	SS
18189	10" x 14"	PL
18188	10" x 14"	PL
18190	10" x 14"	AL

WARNING
Drilling, sawing, sanding or machining wood products can expose you to wood dust, a substance known to the State of California to cause cancer. Avoid inhaling wood dust or use a dust mask or other safeguards for personal protection.

150444	10" x 7"	SS
150443	14" x 10"	SS
150471	10" x 7"	PL
150484	14" x 10"	PL
150442	10" x 7"	AL
150470	14" x 10"	AL

WARNING
Drinking distilled spirits, beer, coolers, wine and other alcoholic beverages may increase cancer risk, and, during pregnancy, can cause birth defects.

150439	10" x 7"	SS
150453	14" x 10"	SS
150478	10" x 7"	PL
150460	14" x 10"	PL
150450	10" x 7"	AL
150477	14" x 10"	AL

WARNING
Many food and beverage cans have linings containing bisphenol A (BPA), a chemical known to the State of California to cause harm to the female reproductive system. Jar lids and bottle caps may also contain BPA. You can be exposed to BPA when you consume foods or beverages packaged in these containers.

150448	10" x 7"	SS
150438	14" x 10"	SS
150452	10" x 7"	PL
150449	14" x 10"	PL
150483	10" x 7"	AL
150463	14" x 10"	AL

WARNING
THIS AREA CONTAINS A CHEMICAL KNOWN TO THE STATE OF CALIFORNIA TO CAUSE CANCER.

80716	5" x 6"	SS
80717	10" x 14"	SS

WARNING
This Area Contains A Chemical Known To The State Of California To Cause Cancer Or Birth Defects Or Other Reproductive Harm

18161	10" x 14"	FB
18157	10" x 14"	SS
18159	10" x 14"	PL
18158	10" x 14"	PL
18160	10" x 14"	AL

WARNING
THIS AREA CONTAINS CHEMICALS KNOWN TO THE STATE OF CALIFORNIA TO CAUSE CANCER

18179	10" x 14"	FB
18175	14" x 10"	SS
18177	10" x 14"	PL
18176	10" x 14"	PL
18178	10" x 14"	AL

WARNING
THIS AREA CONTAINS CHEMICALS KNOWN TO THE STATE OF CALIFORNIA TO CAUSE CANCER, BIRTH DEFECTS, OR OTHER REPRODUCTIVE HARM

18185	10" x 14"	FB
18181	14" x 10"	SS
18183	10" x 14"	PL
18182	10" x 14"	PL

WARNING
THIS AREA CONTAINS CHEMICALS KNOWN TO THE STATE OF CALIFORNIA TO CAUSE CANCER, BIRTH DEFECTS, OR OTHER REPRODUCTIVE HARM. CALIFORNIA HEALTH & SAFETY CODE SECTION 25249.5, ET SEQ.

18184	10" x 14"	AL
-------	-----------	----

WARNING
THIS AREA CONTAINS LEAD, A SUBSTANCE KNOWN TO THE STATE OF CALIFORNIA TO CAUSE BIRTH DEFECTS OR REPRODUCTIVE TOXICITY

18197	10" x 14"	FB
18193	10" x 14"	SS
18195	10" x 14"	PL
18194	10" x 14"	PL
18196	10" x 14"	AL

WARNING
This Facility Permits Smoking And Tobacco. Smokes Known To The State Of California To Cause Cancer.

18167	10" x 14"	FB
18163	10" x 14"	SS
18165	10" x 14"	PL
18164	10" x 14"	PL
18166	10" x 14"	AL

WARNING
This Product May Contain A Chemical Known To The State Of California To Cause Cancer Or Birth Defects Or Other Reproductive Harm

18173	10" x 14"	FB
18169	10" x 14"	SS
18171	10" x 14"	PL
18170	10" x 14"	PL
18172	10" x 14"	AL

Chemical and Hazardous Material Signs

BradyID.com/s36

Hazardous Material Signs

- Most signs include the NFPA Code Number 704M for Hazardous Information
- Clear identification of hazardous chemicals
- Resistant to vapors or spills
- Red legend on white background

Chemical information from the Department of Transportation Guidebook for Hazardous Materials Incidents (SOT 5800.4-1987)

Catalog #	Size	Material	Legend
48893	10 in. x 7 in.	FB 1, 1, 1, Trichloroethane	
48840	10 in. x 7 in.	FB Acetic Acid, Glacial	
48841	10 in. x 7 in.	FB Acetone	
48842	10 in. x 7 in.	FB Acetylene	
48843	10 in. x 7 in.	FB Acrylic Acid	
48845	10 in. x 7 in.	FB Ammonium Hydroxide	
48846	10 in. x 7 in.	FB Anhydrous Ammonia	
48847	10 in. x 7 in.	FB Benzaldehyde	
48848	10 in. x 7 in.	FB Benzene	
48849	10 in. x 7 in.	FB Bromine	
48850	10 in. x 7 in.	FB Butane	
48851	10 in. x 7 in.	FB Butanol	
48852	10 in. x 7 in.	FB Calcium Chloride	
48853	10 in. x 7 in.	FB Calcium Hypochlorite	
48854	10 in. x 7 in.	FB Carbon Dioxide	
48855	10 in. x 7 in.	FB Carbon Disulfide	
48856	10 in. x 7 in.	FB Carbon Tetrachloride	
48857	10 in. x 7 in.	FB Caustic Potash (Potassium Hydroxide)	
48858	10 in. x 7 in.	FB Caustic Soda (Sodium Hydroxide)	
48859	10 in. x 7 in.	FB Chlorine	
48860	10 in. x 7 in.	FB Chloroform	
48861	10 in. x 7 in.	FB Chromic Acid, Solid Chromium Anhydride	
48862	10 in. x 7 in.	FB Diesel Fuel	
48863	10 in. x 7 in.	FB Ethyl Acetate	
48864	10 in. x 7 in.	FB Ethyl Alcohol (Ethanol)	
48865	10 in. x 7 in.	FB Ethylene Glycol	
48866	10 in. x 7 in.	FB Formic Acid	
48867	10 in. x 7 in.	FB Fuel Oil	
48868	10 in. x 7 in.	FB Gasoline	
48869	10 in. x 7 in.	FB Heptane	

Catalog #	Size	Material	Legend
48870	10 in. x 7 in.	FB Hexane	
48871	10 in. x 7 in.	FB Hydrochloric Acid	
48872	10 in. x 7 in.	FB Hydrofluoric Acid	
48873	10 in. x 7 in.	FB Hydrofluorosilicic Acid	
48874	10 in. x 7 in.	FB Hydrogen Peroxide, 52%	
48875	10 in. x 7 in.	FB Isopropanol	
48876	10 in. x 7 in.	FB Isopropyl Acetate	
48877	10 in. x 7 in.	FB Kerosene	
48878	10 in. x 7 in.	FB Mercury	
48879	10 in. x 7 in.	FB Methanol	
48880	10 in. x 7 in.	FB Methyl Ethyl Ketone	
48881	10 in. x 7 in.	FB Muriatic Acid	
48882	10 in. x 7 in.	FB Nitric Acid	
48883	10 in. x 7 in.	FB Nitrogen, Liquid	
48884	10 in. x 7 in.	FB Oxygen, Compressed	
48885	10 in. x 7 in.	FB Phenol	
48886	10 in. x 7 in.	FB Phosphoric Acid	
48887	10 in. x 7 in.	FB Potassium Hydroxide	
48888	10 in. x 7 in.	FB Potassium Perchlorate	
48889	10 in. x 7 in.	FB Potassium Permanganate	
48890	10 in. x 7 in.	FB Propane Gas	
48891	10 in. x 7 in.	FB Sodium Hydroxide	
48892	10 in. x 7 in.	FB Toluene	
48899	10 in. x 7 in.	FB Trichloroethylene	
48894	10 in. x 7 in.	FB Turpentine	
48895	10 in. x 7 in.	FB Unleaded Gasoline	
48896	10 in. x 7 in.	FB Vinyl Acetate	
48897	10 in. x 7 in.	FB Vinyl Chloride	
48898	10 in. x 7 in.	FB Xylene	

Safety Signs

GASOLINE

ACETONE

POTENTIAL HAZARDS

FIRE OR EXPLOSION
Flammable/combustible material. May be ignited by heat, sparks or flames. Vapors may travel to a source of ignition and flash back.
Container may explode in heat of fire. Vapor explosion hazard indoors, outdoors or in sewers.
Runoff to sewer may create fire or explosion hazard.

EMERGENCY ACTION

Keep unnecessary people away; isolate hazard area and deny entry.
Stay upwind; keep out of low areas.
Self-contained breathing apparatus (SCBA) is recommended.
Move container from fire area if you can do so without risk.
Cool containers that are exposed to flames with water from the side until after fire is out. Stay away from ends of tanks.
For massive fire in cargo area, use unmanned hose holder or monitor nozzle. If this is impossible, withdraw from area and let fire burn.
Withdraw immediately in case of rising sound from venting safety device or any discoloration of tank due to fire.

BRADY #48841 BRADY.COM Y3232

HEALTH HAZARDS

May be poisonous if inhaled or absorbed through skin.
Vapors may cause dizziness or suffocation.
Contact may irritate or burn skin and eyes.
Fire may produce irritating or poisonous gases.
Runoff to sewer may cause pollution.

SPILL OR LEAK

Shut off ignition sources; no fires, smoking or flames in hazard area.
Stop leak if you can do it without risk.
Water spray may reduce vapor, but it may not prevent ignition in closed spaces.
Small Spills: Take up with sand or other noncombustible absorbent material and place into containers for later disposal.
Large Spills: Dike far ahead of liquid spill for later disposal.

FIRST AID

Move victim to fresh air and call emergency medical care if not breathing, give artificial respiration; if breathing is difficult, give oxygen.
In case of contact with material, immediately wash eyes with running water for at least 15 minutes. Wash skin with soap and water.
Remove and isolate contaminated clothing and shoes at the site.

POTENTIAL HAZARDS

Explosive. May be ignited by heat, flames or sparks. Vapors may travel to a source of ignition and explode in heat of fire.
On hazard indoors, outdoors or in sewers.

EMERGENCY ACTION

Keep unnecessary people away; isolate hazard area and deny entry.
Stay upwind; keep out of low areas, and ventilate before entering.
Use self-contained breathing apparatus and structural firefighter's equipment if available.
If tank cars are involved in fire, notify fire department.
If tank cars are involved in fire, notify fire department.
If tank cars are involved in fire, notify fire department.

SPILL OR LEAK

Shut off ignition sources; no fires, smoking or flames in hazard area.
Do not touch or walk through spilled material.
Stop leak if you can do it without risk.
Use water spray to reduce vapors; isolate area until gas has dispersed.

FIRST AID

Move victim to fresh air and call emergency medical care if not breathing, give artificial respiration; if breathing is difficult, give oxygen.
In case of frostbite, thaw frostbitten parts with water.
Keep victim quiet and maintain normal body temperature.

BUTANE

POTENTIAL HAZARDS

Explosive. May be ignited by heat, flames or sparks. Vapors may travel to a source of ignition and explode in heat of fire.
On hazard indoors, outdoors or in sewers.

EMERGENCY ACTION

Keep unnecessary people away; isolate hazard area and deny entry.
Stay upwind; keep out of low areas, and ventilate before entering.
Use self-contained breathing apparatus and structural firefighter's equipment if available.
If tank cars are involved in fire, notify fire department.
If tank cars are involved in fire, notify fire department.

SPILL OR LEAK

Shut off ignition sources; no fires, smoking or flames in hazard area.
Do not touch or walk through spilled material.
Stop leak if you can do it without risk.
Use water spray to reduce vapors; isolate area until gas has dispersed.

FIRST AID

Move victim to fresh air and call emergency medical care if not breathing, give artificial respiration; if breathing is difficult, give oxygen.
In case of frostbite, thaw frostbitten parts with water.
Keep victim quiet and maintain normal body temperature.

POTENTIAL HAZARDS

Explosion. May be poisonous if inhaled or absorbed through skin.
Vapors may cause dizziness or suffocation.
Contact may cause severe frostbite.
Fire may produce irritating or poisonous gases.

EMERGENCY ACTION

Keep unnecessary people away; isolate hazard area and deny entry.
Stay upwind; keep out of low areas.
Use self-contained breathing apparatus and structural firefighter's equipment if available.
If tank cars are involved in fire, notify fire department.
If tank cars are involved in fire, notify fire department.

SPILL OR LEAK

Shut off ignition sources; no fires, smoking or flames in hazard area.
Do not touch or walk through spilled material.
Stop leak if you can do it without risk.
Use water spray to reduce vapors; isolate area until gas has dispersed.

FIRST AID

Move victim to fresh air and call emergency medical care if not breathing, give artificial respiration; if breathing is difficult, give oxygen.
In case of frostbite, thaw frostbitten parts with water.
Keep victim quiet and maintain normal body temperature.

462

BRADY

Chemical and Hazardous Material Signs

BradyID.com/s36

Vehicle Placards

- Placards meet D.O.T. requirements 49CFR Part 172
- Placards have square corners and no holes

Sign Selection Guide

PTG - Economical polycoated tagboard - exceeds D.O.T.'s 30-day weather requirement (B-101)

SSV - Self-sticking vinyl - can applied directly to vehicle (B-946)

FB - Premium fiberglass offer over 15 years outdoor durability. (B-120)
Use with Brady Slide-in Placard Holders. (sold separately)



Hazard Division 1.1 Compatibility Group
A, B, C, D, E, F, G, J or L

63300	10.75 in. x 10.75 in.	SSV	EXPLOSIVE 1.1A
63371	10.75 in. x 10.75 in.	PTG	EXPLOSIVE 1.1B
63336	10.75 in. x 10.75 in.	FB	EXPLOSIVE 1.1B
63301	10.75 in. x 10.75 in.	SSV	EXPLOSIVE 1.1B
63372	10.75 in. x 10.75 in.	PTG	EXPLOSIVE 1.1C
63337	10.75 in. x 10.75 in.	FB	EXPLOSIVE 1.1C
63302	10.75 in. x 10.75 in.	SSV	EXPLOSIVE 1.1C
63373	10.75 in. x 10.75 in.	PTG	EXPLOSIVE 1.1D
63303	10.75 in. x 10.75 in.	SSV	EXPLOSIVE 1.1D
63339	10.75 in. x 10.75 in.	FB	EXPLOSIVE 1.1E
63304	10.75 in. x 10.75 in.	SSV	EXPLOSIVE 1.1E
63375	10.75 in. x 10.75 in.	PTG	EXPLOSIVE 1.1F
63340	10.75 in. x 10.75 in.	FB	EXPLOSIVE 1.1F
63376	10.75 in. x 10.75 in.	PTG	EXPLOSIVE 1.1G
63341	10.75 in. x 10.75 in.	FB	EXPLOSIVE 1.1G
63306	10.75 in. x 10.75 in.	SSV	EXPLOSIVE 1.1G
63377	10.75 in. x 10.75 in.	PTG	EXPLOSIVE 1.1J
63342	10.75 in. x 10.75 in.	FB	EXPLOSIVE 1.1J
63307	10.75 in. x 10.75 in.	SSV	EXPLOSIVE 1.1J
63378	10.75 in. x 10.75 in.	PTG	EXPLOSIVES 1.1L
63308	10.75 in. x 10.75 in.	SSV	EXPLOSIVES 1.1L



Hazard Division 1.2 Compatibility Group
B, C, D, E, F, G, H, J, K or L

63344	10.75 in. x 10.75 in.	FB	EXPLOSIVE 1.2B
63380	10.75 in. x 10.75 in.	PTG	EXPLOSIVE 1.2C
63345	10.75 in. x 10.75 in.	FB	EXPLOSIVE 1.2C
63310	10.75 in. x 10.75 in.	SSV	EXPLOSIVE 1.2C
63381	10.75 in. x 10.75 in.	PTG	EXPLOSIVE 1.2D
63346	10.75 in. x 10.75 in.	FB	EXPLOSIVE 1.2D
63311	10.75 in. x 10.75 in.	SSV	EXPLOSIVE 1.2D
63347	10.75 in. x 10.75 in.	FB	EXPLOSIVE 1.2E
63312	10.75 in. x 10.75 in.	SSV	EXPLOSIVE 1.2E
63383	10.75 in. x 10.75 in.	PTG	EXPLOSIVE 1.2F
63348	10.75 in. x 10.75 in.	FB	EXPLOSIVE 1.2F
63313	10.75 in. x 10.75 in.	SSV	EXPLOSIVE 1.2F
63384	10.75 in. x 10.75 in.	PTG	EXPLOSIVE 1.2G
63349	10.75 in. x 10.75 in.	FB	EXPLOSIVE 1.2G
63314	10.75 in. x 10.75 in.	SSV	EXPLOSIVE 1.2G
63385	10.75 in. x 10.75 in.	PTG	EXPLOSIVE 1.2H
63350	10.75 in. x 10.75 in.	FB	EXPLOSIVE 1.2H
63386	10.75 in. x 10.75 in.	PTG	EXPLOSIVE 1.2J
63351	10.75 in. x 10.75 in.	FB	EXPLOSIVE 1.2J
63316	10.75 in. x 10.75 in.	SSV	EXPLOSIVE 1.2J
63387	10.75 in. x 10.75 in.	PTG	EXPLOSIVE 1.2K
63352	10.75 in. x 10.75 in.	FB	EXPLOSIVE 1.2K
63317	10.75 in. x 10.75 in.	SSV	EXPLOSIVE 1.2K
63353	10.75 in. x 10.75 in.	FB	EXPLOSIVES 1.2L
63318	10.75 in. x 10.75 in.	SSV	EXPLOSIVES 1.2L



Hazard Division 1.3 Compatibility Group
C, F, G, H, J, K or L

63389	10.75 in. x 10.75 in.	PTG	EXPLOSIVE 1.3C
63354	10.75 in. x 10.75 in.	FB	EXPLOSIVE 1.3C
63390	10.75 in. x 10.75 in.	PTG	EXPLOSIVE 1.3F
63355	10.75 in. x 10.75 in.	FB	EXPLOSIVE 1.3F
63320	10.75 in. x 10.75 in.	SSV	EXPLOSIVE 1.3F
63356	10.75 in. x 10.75 in.	FB	EXPLOSIVE 1.3G
63321	10.75 in. x 10.75 in.	SSV	EXPLOSIVE 1.3G
63392	10.75 in. x 10.75 in.	PTG	EXPLOSIVE 1.3H
63357	10.75 in. x 10.75 in.	FB	EXPLOSIVE 1.3H
63322	10.75 in. x 10.75 in.	SSV	EXPLOSIVE 1.3H
63393	10.75 in. x 10.75 in.	PTG	EXPLOSIVE 1.3J
63358	10.75 in. x 10.75 in.	FB	EXPLOSIVE 1.3J
63323	10.75 in. x 10.75 in.	SSV	EXPLOSIVE 1.3J
63394	10.75 in. x 10.75 in.	PTG	EXPLOSIVE 1.3K
63359	10.75 in. x 10.75 in.	FB	EXPLOSIVE 1.3K
63324	10.75 in. x 10.75 in.	SSV	EXPLOSIVE 1.3K
63395	10.75 in. x 10.75 in.	PTG	EXPLOSIVES 1.3L
63360	10.75 in. x 10.75 in.	FB	EXPLOSIVES 1.3L
63325	10.75 in. x 10.75 in.	SSV	EXPLOSIVES 1.3L



Hazard Division 1.4 Compatibility Group
B, C, D, E, F, G or S

63396	10.75 in. x 10.75 in.	PTG	EXPLOSIVE 1.4B
63361	10.75 in. x 10.75 in.	FB	EXPLOSIVE 1.4B
63326	10.75 in. x 10.75 in.	SSV	EXPLOSIVE 1.4B
63362	10.75 in. x 10.75 in.	FB	EXPLOSIVE 1.4C
63327	10.75 in. x 10.75 in.	SSV	EXPLOSIVE 1.4C
63363	10.75 in. x 10.75 in.	FB	EXPLOSIVE 1.4D
63328	10.75 in. x 10.75 in.	SSV	EXPLOSIVE 1.4D
63399	10.75 in. x 10.75 in.	PTG	EXPLOSIVE 1.4E
63364	10.75 in. x 10.75 in.	FB	EXPLOSIVE 1.4E
63400	10.75 in. x 10.75 in.	PTG	EXPLOSIVE 1.4F
63365	10.75 in. x 10.75 in.	FB	EXPLOSIVE 1.4F
63366	10.75 in. x 10.75 in.	FB	EXPLOSIVE 1.4G
63331	10.75 in. x 10.75 in.	SSV	EXPLOSIVE 1.4G
63332	10.75 in. x 10.75 in.	SSV	EXPLOSIVES 1.4S



Hazard Division 1.5 Compatibility Group
D

63403	10.75 in. x 10.75 in.	PTG	1.5 BLASTING AGENTS D 1
63368	10.75 in. x 10.75 in.	FB	1.5 BLASTING AGENTS D 1
63333	10.75 in. x 10.75 in.	SSV	1.5 BLASTING AGENTS D 1



Hazard Division 1.6 Compatibility Group
N

63404	10.75 in. x 10.75 in.	PTG	1.6 EXPLOSIVE N 1
63369	10.75 in. x 10.75 in.	FB	1.6 EXPLOSIVE N 1
63334	10.75 in. x 10.75 in.	SSV	1.6 EXPLOSIVE N 1

Chemical and Hazardous Material Signs

BradyID.com/s36

D.O.T. Hazardous Material Shipping Placards

- Placards meet D.O.T. requirements 49CFR Part 172
- Placards have square corners and no holes
- Dimensions: 10.75" x 10.75"











Sign Selection Guide

PTG - Economical polycoated tagboard - exceeds D.O.T.'s 30-day weather requirement (B-101)





SSV - Self-sticking vinyl - can applied directly to vehicle (B-946)

FB - Premium fiberglass offer over 15 years outdoor durability. (B-120)
Use with Brady Slide-in Placard Holders. (sold separately)







Class 2

									
63439 PTG	60391 PTG 60407 FB 60375 SSV	63436 FB 63406 SS	60428 PTG 60423 FB 60433 SSV	60434 SSV	60421 FB	63442 PTG 63438 FB	60409 FB 60377 SSV	63441 PTG 63437 FB 63407 SSV	60408 FB 60376 SSV





Class 3

			
63444 PTG 63423 FB 63410 SSV	63443 PTG 63422 FB 63409 SSV	63411 SSV	60394 PTG 60410 FB 60378 SSV







Class 4

					
60398 PTG 60414 FB 60382 SSV	60413 FB	60412 FB 60380 SSV	63448 PTG 63414 SSV	63446 PTG 63425 FB 63412 SSV	63447 PTG 63426 FB

Class 5

			
60383 SSV	63449 PTG 63428 FB 63415 SSV	60400 PTG 60416 FB 60384 SSV	63429 FB



Class 6

					
60390 SSV	60402 PTG	63452 PTG 63431 FB 63418 SSV	60427 FB	60431 PTG 60426 FB 60436 SSV	60425 FB 60435 SSV



Class 7

63419 SSV

Class 8

	
60403 PTG 60419 FB 60387 SSV	63454 PTG 63433 FB 63420 SSV

Class 9

	
60404 PTG 60388 SSV	63455 PTG 63434 FB 63421 SSV

Mixed Loads

63212 PTG 76259 FB 76394 SSV

Safety Signs

Die-Cut Placard Numbers

Catalog #	Description	Qty.
5010-*	3 in. Quik-Align Numbers	10pk

Replace () with the desired number (0-9).
Example: To order die-cut "2" order # 5010-2.



4 in. x 4 in. labels
also available.
View page 376.



Chemical and Hazardous Material Signs

BradyID.com/s36

Flip-Style Vehicle Placards



Split-frame

One-piece frame

Cargo Tank Placards

- Flipping numerals give you the flexibility to set-up any 4-digit identification number in seconds
- Durable, heavy-duty aluminum frame assures stability in the wind and saves money on placard replacement costs
- Included legends:
 - Blank
 - Flammable 3
 - Corrosive 8
 - Combustible 3
 - Poison 6

Catalog #	Description	Qty.
63214	One-Piece Frame	1

Welding Supply and Medical Van Placards

- Standard flip-file system contain multiple panels in one frame
- Self-contained placards slide easily on for aluminum hinges
- Four stainless steel fasteners securely lock in your chosen legend
- Deep-formed aluminum frame provides stability and excellent wind protection
- Included legends:
 - Blank
 - Flammable Gas 2
 - Non-Flammable Gas 2
 - Oxygen 2

Catalog #	Description	Qty.
63200	One-Piece Frame	1

General Commodities Placards

- Approved for private and fleet carriers
- Split frame available for roll up doors
- Self-contained placards slide easily on for aluminum hinges
- Four stainless steel fasteners securely lock in your chosen legend
- Deep-formed aluminum frame provides stability and excellent wind protection
- Included legends:
 - Blank
 - Blasting Agents 1.5d
 - Corrosive 8
 - Dangerous
 - Dangerous When Wet 4
 - Explosive 1.4
 - Flammable 2
 - Flammable Gas 2
 - Flammable Solid 4
 - Inhalation 2
 - Inhalation 6
 - Misc. 9
 - Non-Flammable Gas 2
 - Organic Peroxide 5.2
 - Oxidizer 5.1
 - Poison 6
 - Spontaneously Combustible 4

Catalog #	Description	Qty.
59955	One-Piece Frame	1
59956	Split-Frame for roll up doors	1

Vehicle Conspicuity Tape

- Made of B-752 material that is a diamond grade reflective sheeting backed with a pressure sensitive adhesive
- Average outdoor durability of 7 years
- Kits available that contain enough material to mark a trailer per the NHTSA Regulation for enhanced visibility and detection

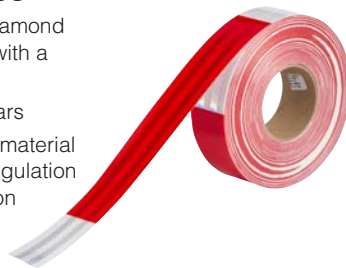

Catalog #	Description	Qty.
76434	DOT-C2 2 in. x 50 ft. roll solid white	1 roll
76436	DOT-C2 2 in. x 50 ft. roll (alternating 7 in. white / 11 in. red)	1 roll
76437	(1) 2 in. x 75 ft. white / red roll (1) Squeegee and instructions	1 kit
76438	Large 53-57 ft. Truck Kit (36) 2 in. x 18 in. solid white strips (sides) (4) 2 in. x 12 in. red / white strips (corners) (1) 2 in. x 90 in. red / white strips (bumper / door) (1) 1.5 in. x 90 in. red / white strips (underride) (1) Squeegee and instructions	1 kit
76439	Small 45-48 ft. Truck Kit (32) 2 in. x 18 in. solid white strips (sides) (4) 2 in. x 12 in. red / white strips (corners) (1) 2 in. x 90 in. red / white strips (bumper / door) (1) 1.5 in. x 90 in. red / white strips (underride) (1) Squeegee and instructions	1 kit



Placard Holders

- Slide-in placard holder mounts vehicle placards to your vehicle
- Features easy-off guides over the retaining clip so placards slide easily

Catalog #	Description	Qty.
60142	Split Frame	1
60141	Frame without clipped corners	1
60143	Frame with 2 clipped corners	1

Confined Space Signs

BradyID.com/s36

Confined Space Signs

Brady offers a variety of confined space signs to help you identify your confined workspace areas including tanks, electrical rooms and enclosures. These confined space signs include warnings for authorized or permit entry areas. Brady's confined space signs also communicate required protective gear including gloves, eye protection or hearing protection.

Sign Selection Guide

- FB** - Premium fiberglass (B-120)
- SS** - Self-sticking polyester (B-302)
- PL** - Plastic (B-401)
- AL** - Aluminum (B-555)
- BGSS** - BradyGlo™ self-stick polyester (B-324)
- BGPL** - BradyGlo™ plastic (B-347)

Material Comparison page 408
Sign Legend Index..... page 588

126698 7' x 10' SS 126701 10' x 14' SS 126697 7' x 10' PL 126700 10' x 14' PL 126696 7' x 10' AL 126699 10' x 14' AL	76077 10' x 14' FB 84516 10' x 14' SS 40953 7' x 10' AL 40954 10' x 14' AL	126704 10' x 7' SS 126707 14' x 10' SS 126703 10' x 7' PL 126706 14' x 10' PL 126702 10' x 7' AL 126705 14' x 10' AL	126710 7' x 10' SS 126713 10' x 14' SS 126709 7' x 10' PL 126712 10' x 14' PL 126708 7' x 10' AL 126711 10' x 14' AL	124267 7' x 10' SS 124270 10' x 14' SS 124266 7' x 10' PL 124269 10' x 14' PL 124265 7' x 10' AL 124268 10' x 14' AL	126716 7' x 10' SS 126719 10' x 14' SS 126715 7' x 10' PL 126718 10' x 14' PL 126714 7' x 10' AL 126717 10' x 14' AL

126728 7' x 10' SS 126731 10' x 14' SS 126727 7' x 10' PL 126730 10' x 14' PL 126726 7' x 10' AL 126729 10' x 14' AL	124288 7' x 10' SS 124291 10' x 14' SS 124287 7' x 10' PL 124290 10' x 14' PL 124286 7' x 10' AL 124289 10' x 14' AL	126722 7' x 10' SS 126725 10' x 14' SS 126721 7' x 10' PL 126724 10' x 14' PL 126720 7' x 10' AL 126723 10' x 14' AL	126734 7' x 10' SS 126737 10' x 14' SS 126733 7' x 10' PL 126736 10' x 14' PL 126732 7' x 10' AL 126735 10' x 14' AL	126740 7' x 10' SS 126743 10' x 14' SS 126739 7' x 10' PL 126742 10' x 14' PL 126738 7' x 10' AL 126741 10' x 14' AL	126752 7' x 10' SS 126755 10' x 14' SS 126751 7' x 10' PL 126754 10' x 14' PL 126750 7' x 10' AL 126753 10' x 14' AL

22409 7' x 10' PL 22410 10' x 14' PL 40973 7' x 10' AL 40974 10' x 14' AL	84542 10' x 14' SS 22411 7' x 10' PL 22412 10' x 14' PL 40975 7' x 10' AL	124237 7' x 10' SS 124240 10' x 14' SS 124236 7' x 10' PL 124239 10' x 14' PL 124235 7' x 10' AL 124238 10' x 14' AL	84558 7' x 10' SS 84559 10' x 14' SS 22420 7' x 10' PL 22421 10' x 14' PL 40984 7' x 10' AL	84560 7' x 10' SS 84561 10' x 14' SS 40987 10' x 14' AL	126746 7' x 10' SS 126749 10' x 14' SS 126745 7' x 10' PL 126748 10' x 14' PL 126744 7' x 10' AL 126747 10' x 14' AL

126758 7' x 10' SS 126761 10' x 14' SS 126757 7' x 10' PL 126760 10' x 14' PL 126756 7' x 10' AL 126759 10' x 14' AL	95012 7' x 10' FB 95013 10' x 14' FB 95018 7' x 10' SS 60569 10' x 14' SS 95015 7' x 10' PL 60535 10' x 14' PL 95014 7' x 10' AL 60506 10' x 14' AL	131685 7' x 10' FB 131686 10' x 14' FB 131683 7' x 10' SS 131681 7' x 10' PL 131682 10' x 14' PL 131679 7' x 10' AL 131680 10' x 14' AL	126812 7' x 10' SS 126815 10' x 14' SS 126811 7' x 10' PL 126814 10' x 14' PL 126810 7' x 10' AL 126813 10' x 14' AL	126782 7' x 10' SS 126781 7' x 10' PL 126784 10' x 14' PL 126780 7' x 10' AL 126783 10' x 14' AL	123715 7' x 10' SS 123718 10' x 14' SS 123714 7' x 10' PL 123717 10' x 14' PL 123713 7' x 10' AL 123716 10' x 14' AL

Safety Signs

Confined Space Signs (continued)



126764	7" x 10"	SS
126767	10" x 14"	SS
126763	7" x 10"	PL
126766	10" x 14"	PL
126762	7" x 10"	AL
126765	10" x 14"	AL



126794	7" x 10"	SS
126797	10" x 14"	SS
126793	7" x 10"	PL
126796	10" x 14"	PL
126792	7" x 10"	AL
126795	10" x 14"	AL



70248	7" x 10"	FB
70249	10" x 14"	FB
87748	3.5" x 5"	SS
84562	7" x 10"	SS
84563	10" x 14"	SS
22424	7" x 10"	PL
22425	10" x 14"	PL
40988	7" x 10"	AL
40989	10" x 14"	AL



87674	7" x 10"	FB
87675	10" x 14"	FB
19191	7" x 10"	SS
19197	10" x 14"	SS
19193	7" x 10"	PL
19199	10" x 14"	PL
19194	7" x 10"	AL
19200	10" x 14"	AL



122812	7" x 10"	FB
122787	14" x 10"	FB
65909	20" x 14"	FB
122649	7" x 10"	SS
84564	14" x 10"	SS
122516	7" x 10"	PL
22426	14" x 10"	PL
122405	7" x 10"	AL



126818	7" x 10"	SS
126821	10" x 14"	SS
126817	7" x 10"	PL
126820	10" x 14"	PL
126816	7" x 10"	AL
126819	10" x 14"	AL



123643	7" x 10"	SS
123646	10" x 14"	SS
123642	7" x 10"	PL
123645	10" x 14"	PL
123641	7" x 10"	AL
123644	10" x 14"	AL



126800	7" x 10"	SS
126803	10" x 14"	SS
126799	7" x 10"	PL
126802	10" x 14"	PL
126798	7" x 10"	AL
126801	10" x 14"	AL

Regulations

Permit Required Confined Space, Do Not Enter 1910.146(c)(2)

Exposed employees must be informed of the existence and location of and the danger posed by permit-required confined spaces through the posting of danger signs or by any other equally effective means. A sign reading "DANGER – PERMIT – REQUIRED CONFINED SPACE, DO NOT ENTER" or using other similar language satisfies the requirement.

Accident Prevention 1910.145(c)(2)

Caution signs shall be used only to warn against potential hazards or to caution against unsafe practices. All employees shall be instructed that caution signs indicate a possible hazard against which proper precaution should be taken.



40991	10" x 7"	AL
40992	14" x 10"	AL



122811	7" x 10"	FB
122713	10" x 14"	FB
73408	14" x 20"	FB
87773	3.5" x 5"	SS
84567	7" x 10"	SS
84568	10" x 14"	SS
22429	7" x 10"	PL
22430	10" x 14"	PL
40993	7" x 10"	AL
40994	10" x 14"	AL



70250	20" x 14"	FB
84566	14" x 10"	SS



70252	20" x 14"	FB
84569	10" x 7"	SS
84570	14" x 10"	SS
22432	14" x 10"	PL
40995	10" x 7"	AL
40996	14" x 10"	AL



126788	7" x 10"	SS
126791	10" x 14"	SS
126787	7" x 10"	PL
126790	10" x 14"	PL
126786	7" x 10"	AL
126789	10" x 14"	AL



123649	7" x 10"	SS
123652	10" x 14"	SS
123648	7" x 10"	PL
123651	10" x 14"	PL
123647	7" x 10"	AL
123650	10" x 14"	AL



126776	7" x 10"	SS
126779	10" x 14"	SS
126775	7" x 10"	PL
126778	10" x 14"	PL
126774	7" x 10"	AL
126777	10" x 14"	AL



123673	10" x 7"	SS
123676	14" x 10"	SS
123672	10" x 7"	PL
123675	14" x 10"	PL
123671	10" x 7"	AL
123674	14" x 10"	AL



126770	7" x 10"	SS
126773	10" x 14"	SS
126769	7" x 10"	PL
126772	10" x 14"	PL
126768	7" x 10"	AL
126771	10" x 14"	AL



Confined Space Signs

BradyID.com/s36

Confined Space Signs (continued)



126836	7' x 10'	SS
126839	10' x 14'	SS
126835	7' x 10'	PL
126838	10' x 14'	PL
126834	7' x 10'	AL
126837	10' x 14'	AL



131693	7' x 10'	FB
131694	10' x 14'	FB
131691	7' x 10'	SS
131692	10' x 14'	SS
131689	7' x 10'	PL
131690	10' x 14'	PL
131687	7' x 10'	AL
131688	10' x 14'	AL



126806	7' x 10'	SS
126809	10' x 14'	SS
126805	7' x 10'	PL
126808	10' x 14'	PL
126804	7' x 10'	AL
126807	10' x 14'	AL



126830	7' x 10'	SS
126833	10' x 14'	SS
126829	7' x 10'	PL
126832	10' x 14'	PL
126828	7' x 10'	AL
126831	10' x 14'	AL

Sign Selection Guide

- FB - Premium fiberglass (B-120)
- SS - Self-sticking polyester (B-302)
- PL - Plastic (B-401)
- AL - Aluminum (B-555)
- BGSS - BradyGlo™ self-stick polyester (B-324)
- BGPL - BradyGlo™ plastic (B-347)

Material Comparison page 408
Sign Legend Index..... page 588



123607	7' x 10'	SS
123610	10' x 14'	SS
123606	7' x 10'	PL
123609	10' x 14'	PL
123605	7' x 10'	AL
123608	10' x 14'	AL



40999	7' x 10'	AL
-------	----------	----



123625	7' x 10'	SS
123628	10' x 14'	SS
123624	7' x 10'	PL
123627	10' x 14'	PL
123623	7' x 10'	AL
123626	10' x 14'	AL



126824	7' x 10'	SS
126827	10' x 14'	SS
126823	7' x 10'	PL
126826	10' x 14'	PL
126822	7' x 10'	AL
126825	10' x 14'	AL



65948	7' x 10'	FB
65817	10' x 14'	FB
87768	3.5' x 5'	SS
65950	7' x 10'	SS
65949	10' x 14'	SS
25920	7' x 10'	PL
25921	10' x 14'	PL
43517	7' x 10'	AL
43518	10' x 14'	AL



84575	7' x 10'	SS
22437	7' x 10'	PL
22438	10' x 14'	PL
41001	7' x 10'	AL
41002	10' x 14'	AL



84577	7' x 10'	SS
41003	7' x 10'	AL



82595	7' x 10'	SS
82596	10' x 14'	SS
20027	7' x 10'	PL
20028	10' x 14'	PL
49069	7' x 10'	AL
49070	10' x 14'	AL
60241	10' x 14'	FB



65910	10' x 14'	FB
22441	7' x 10'	PL
41006	10' x 14'	AL

Safety Signs

Confined Space Manhole Cover Signs

- Polystyrene manhole signs fit under most standard manhole covers
- Sign is visible only when the cover is removed from the confined space entry point



43760	Fits 21" to 30" dia.
47204	Fits 30.5" to 42" dia.



43759	Fits 21" to 30" dia.
47198	Fits 30.5" to 42" dia.



43754	Fits 21" to 30" dia.
47196	Fits 30.5" to 42" dia.



43753	Fits 21" to 30" dia.
-------	----------------------



43758	Fits 21" to 30" dia.
-------	----------------------



43747	Fits 21" to 30" dia.
-------	----------------------



43748	Fits 21" to 30" dia.
-------	----------------------

Construction Site Signs

Brady construction signs are a highly visible, effective way to warn employees, pedestrians and visitors of the potential dangers of construction areas. These signs indicate a wide range of warnings including employee locations, temporary road closings and more. Brady also offers additional traffic control signs to identify traffic lane closings, shoulder closings, and other construction areas.



126866	7" x 10"	SS
126869	10" x 14"	SS
126865	7" x 10"	PL
126868	10" x 14"	PL
126864	7" x 10"	AL
126867	10" x 14"	AL



126872	7" x 10"	SS
126875	10" x 14"	SS
126871	7" x 10"	PL
126874	10" x 14"	PL
126870	7" x 10"	AL
126873	10" x 14"	AL



60570	10" x 14"	SS
95351	7" x 10"	PL
60536	10" x 14"	PL
95352	7" x 10"	AL
60507	10" x 14"	AL



73451	10" x 14"	FB
95401	7" x 10"	SS
60571	10" x 14"	SS
25804	10" x 14"	PL
43381	10" x 14"	AL



126878	7" x 10"	SS
126881	10" x 14"	SS
126877	7" x 10"	PL
126880	10" x 14"	PL
126876	7" x 10"	AL
126879	10" x 14"	AL



122903	7" x 10"	FB
122765	10" x 14"	FB
70255	24" x 36"	FB
122695	7" x 10"	SS
122619	10" x 14"	SS
122559	7" x 10"	PL
25805	10" x 14"	PL
122452	7" x 10"	AL
43382	10" x 14"	AL



126884	7" x 10"	SS
126887	10" x 14"	SS
126883	7" x 10"	PL
126886	10" x 14"	PL
126882	7" x 10"	AL
126885	10" x 14"	AL



126890	7" x 10"	SS
126893	10" x 14"	SS
126889	7" x 10"	PL
126892	10" x 14"	PL
126888	7" x 10"	AL
126891	10" x 14"	AL



126896	7" x 10"	SS
126899	10" x 14"	SS
126895	7" x 10"	PL
126898	10" x 14"	PL
126894	7" x 10"	AL
126897	10" x 14"	AL



126902	7" x 10"	SS
126905	10" x 14"	SS
126901	7" x 10"	PL
126904	10" x 14"	PL
126900	7" x 10"	AL
126903	10" x 14"	AL



126908	7" x 10"	SS
126911	10" x 14"	SS
126907	7" x 10"	PL
126910	10" x 14"	PL
126906	7" x 10"	AL
126909	10" x 14"	AL



126914	7" x 10"	SS
126917	10" x 14"	SS
126913	7" x 10"	PL
126916	10" x 14"	PL
126912	7" x 10"	AL
126915	10" x 14"	AL



126932	7" x 10"	SS
126935	10" x 14"	SS
126931	7" x 10"	PL
126934	10" x 14"	PL
126930	7" x 10"	AL
126933	10" x 14"	AL



126920	7" x 10"	SS
126923	10" x 14"	SS
126919	7" x 10"	PL
126922	10" x 14"	PL
126918	7" x 10"	AL
126921	10" x 14"	AL



126926	7" x 10"	SS
126929	10" x 14"	SS
126925	7" x 10"	PL
126928	10" x 14"	PL
126924	7" x 10"	AL
126927	10" x 14"	AL



126848	7" x 10"	SS
126851	10" x 14"	SS
126847	7" x 10"	PL
126850	10" x 14"	PL
126846	7" x 10"	AL
126849	10" x 14"	AL



126842	7" x 10"	SS
126845	10" x 14"	SS
126841	7" x 10"	PL
126844	10" x 14"	PL
126840	7" x 10"	AL
126843	10" x 14"	AL



126854	7" x 10"	SS
126857	10" x 14"	SS
126853	7" x 10"	PL
126856	10" x 14"	PL
126852	7" x 10"	AL
126855	10" x 14"	AL



126860	7" x 10"	SS
126863	10" x 14"	SS
126859	7" x 10"	PL
126862	10" x 14"	PL
126858	7" x 10"	AL
126861	10" x 14"	AL

Door Signs

BradyID.com/s36

Door Signs

Brady door signs are for marking doors that must be kept closed, emergency exits, fire exits and more. With bright, noticeable colors and a wide range of sizes and materials, Brady has a sign for every door in your facility.

Sign Selection Guide

- FB** - Premium fiberglass (B-120)
- SS** - Self-sticking polyester (B-302)
- PL** - Plastic (B-401)
- AL** - Aluminum (B-555)
- BGSS** - BradyGlo™ self-stick polyester (B-324)
- BGPL** - BradyGlo™ plastic (B-347)

Material Comparison page 408
 Sign Legend Index..... page 588



70245	10" x 14"	FB
84692	10" x 14"	SS
22505	7" x 10"	PL
41069	7" x 10"	AL
41070	10" x 14"	AL



95272	7" x 17"	FB
-------	----------	----



84695	7" x 10"	SS
84696	10" x 14"	SS
22507	7" x 10"	PL
22508	10" x 14"	PL
41071	7" x 10"	AL



84697	7" x 10"	SS
84698	10" x 14"	SS
22509	7" x 10"	PL
22510	10" x 14"	PL
41073	7" x 10"	AL
41074	10" x 14"	AL



47075	7" x 10"	FB
47113	10" x 14"	FB
84699	7" x 10"	SS
84700	10" x 14"	SS
22511	7" x 10"	PL
22512	10" x 14"	PL
41075	7" x 10"	AL
41076	10" x 14"	AL



84702	7" x 10"	SS
84703	10" x 14"	SS



71106	10" x 14"	FB
84704	7" x 10"	SS
84705	10" x 14"	SS
22513	7" x 10"	PL
22514	10" x 14"	PL
41077	7" x 10"	AL
41078	10" x 14"	AL



122844	7" x 10"	FB
70466	10" x 14"	FB
87775	3.5" x 5"	SS
84706	7" x 10"	SS
84707	10" x 14"	SS
22515	7" x 10"	PL
22516	10" x 14"	PL
41079	7" x 10"	AL
41080	10" x 14"	AL



70532	10" x 14"	FB
84710	7" x 10"	SS
84711	10" x 14"	SS
22519	7" x 10"	PL
22520	10" x 14"	PL
41084	10" x 14"	AL



70542	7" x 10"	FB
84712	7" x 10"	SS
84713	10" x 14"	SS
22521	7" x 10"	PL
22522	10" x 14"	PL
41085	7" x 10"	AL
41086	10" x 14"	AL



84714	7" x 10"	SS
84715	10" x 14"	SS
22523	7" x 10"	PL
22524	10" x 14"	PL
41087	7" x 10"	AL
41088	10" x 14"	AL



84716	7" x 10"	SS
84717	10" x 14"	SS
22525	7" x 10"	PL
22526	10" x 14"	PL
41090	10" x 14"	AL



84718	7" x 10"	SS
84719	10" x 14"	SS
22527	7" x 10"	PL
22528	10" x 14"	PL



132058	7" x 10"	FB
69091	10" x 14"	FB
87776	3.5" x 5"	SS
84720	7" x 10"	SS
84721	10" x 14"	SS
132059	7" x 10"	PL
22530	10" x 14"	PL
41093	7" x 10"	AL
41094	10" x 14"	AL



84725	10" x 14"	SS
22532	10" x 14"	PL
41095	7" x 10"	AL
41096	10" x 14"	AL



84726	7" x 10"	SS
84727	10" x 14"	SS
22533	7" x 10"	PL
22534	10" x 14"	PL
41097	7" x 10"	AL
41098	10" x 14"	AL



127058	7" x 10"	SS
127061	10" x 14"	SS
127057	7" x 10"	PL
127060	10" x 14"	PL
127056	7" x 10"	AL
127059	10" x 14"	AL



84730	7" x 10"	SS
22535	7" x 10"	PL
41099	7" x 10"	AL
41100	10" x 14"	AL



87774	3.5" x 5"	SS
-------	-----------	----



73414	7" x 17"	FB
-------	----------	----



127064	7" x 10"	SS
127067	10" x 14"	SS
127063	7" x 10"	PL
127066	10" x 14"	PL
127062	7" x 10"	AL
127065	10" x 14"	AL



70548	10" x 14"	FB
84738	7" x 10"	SS
84739	10" x 14"	SS
22543	7" x 10"	PL
22544	10" x 14"	PL
41107	7" x 10"	AL
41108	10" x 14"	AL

Safety Signs

Door Signs (continued)



127076	7" x 10"	SS
127079	10" x 14"	SS
127075	7" x 10"	PL
127078	10" x 14"	PL
127074	7" x 10"	AL
127077	10" x 14"	AL



69607	10" x 14"	FB
84740	7" x 10"	SS
84741	10" x 14"	SS
22545	7" x 10"	PL
22546	10" x 14"	PL
41109	7" x 10"	AL
41110	10" x 14"	AL



127082	7" x 10"	SS
127085	10" x 14"	SS
127081	7" x 10"	PL
127084	10" x 14"	PL
127080	7" x 10"	AL
127083	10" x 14"	AL



124304	6" dia.	SS
--------	---------	----



132115	10" x 14"	FB
132114	10" x 14"	PL
132113	10" x 14"	AL



127094	7" x 10"	SS
127097	10" x 14"	SS
127093	7" x 10"	PL
127096	10" x 14"	PL
127092	7" x 10"	AL
127095	10" x 14"	AL



123817	7" x 10"	SS
123820	10" x 14"	SS
123816	7" x 10"	PL
123819	10" x 14"	PL
123815	7" x 10"	AL
123818	10" x 14"	AL

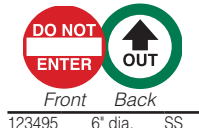

123495	6" dia.	SS
--------	---------	----

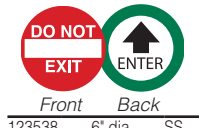

123538	6" dia.	SS
--------	---------	----



124627	3.5" x 10"	SS
124626	3.5" x 10"	PL
124625	3.5" x 10"	AL



132124	10" x 14"	FB
132123	10" x 14"	PL
132122	10" x 14"	AL



132130	10" x 14"	FB
132129	10" x 14"	PL
132128	10" x 14"	AL



84746	3.5" x 5"	SS
84747	5" x 14"	SS



84748	7" x 10"	SS
84749	10" x 14"	SS
22549	7" x 10"	PL
41113	7" x 10"	AL



84750	3.5" x 10"	SS
-------	------------	----



84751	7" x 10"	SS
84752	10" x 14"	SS
25881	7" x 10"	PL
43458	7" x 10"	AL



69302	10" x 14"	FB
84755	7" x 10"	SS
84756	10" x 14"	SS
22550	7" x 10"	PL
22551	10" x 14"	PL



73463	10" x 14"	FB
84757	7" x 10"	SS
84758	10" x 14"	SS
22552	7" x 10"	PL
22553	10" x 14"	PL
41116	7" x 10"	AL
41117	10" x 14"	AL



132106	10" x 14"	FB
132105	10" x 14"	PL
132104	10" x 14"	AL



132118	10" x 14"	FB
132117	10" x 14"	PL
132116	10" x 14"	AL



132121	10" x 14"	FB
132120	10" x 14"	PL
132119	10" x 14"	AL



124630	3.5" x 10"	SS
124629	3.5" x 10"	PL
124628	3.5" x 10"	AL



132109	10" x 14"	FB
132108	10" x 14"	PL
132107	10" x 14"	AL



69415	10" x 14"	FB
84761	7" x 10"	SS
84762	10" x 14"	SS
22555	10" x 14"	PL



132112	10" x 14"	FB
132111	10" x 14"	PL
132110	10" x 14"	AL



132127	10" x 14"	FB
132126	10" x 14"	PL
132125	10" x 14"	AL



84767	3.5" x 10"	SS
-------	------------	----



122904	7" x 10"	FB
122766	10" x 14"	FB
84768	7" x 10"	SS
84769	10" x 14"	SS
22558	7" x 10"	PL
22559	10" x 14"	PL
122453	7" x 10"	AL
41123	10" x 14"	AL



85747	5" x 14"	SS
-------	----------	----

Electrical Hazard Signs

BradyID.com/s36

Electrical Hazard Signs

Brady electrical hazard signs can be used throughout your facility to identify electrical hazards and high voltage areas. These electrical signs use bright colors, pictograms and legends to warn against entry, machine operation and buried cables.

Sign Selection Guide

- FB** - Premium fiberglass (B-120)
- SS** - Self-sticking polyester (B-302)
- PL** - Plastic (B-401)
- AL** - Aluminum (B-555)
- BGSS** - BradyGlo™ self-stick polyester (B-324)
- BGPL** - BradyGlo™ plastic (B-347)

Material Comparison page 408
Sign Legend Index..... page 588



122862	7" x 10"	FB
122724	10" x 14"	FB
84827	7" x 10"	SS
84828	10" x 14"	SS
122528	7" x 10"	PL
122477	10" x 14"	PL
122419	7" x 10"	AL
122353	10" x 14"	AL



71425	10" x 14"	FB
84829	7" x 10"	SS
84830	10" x 14"	SS
25502	7" x 10"	PL
25503	10" x 14"	PL
43079	7" x 10"	AL
43080	10" x 14"	AL



69292	10" x 14"	FB
84831	7" x 10"	SS
84832	10" x 14"	SS
25505	10" x 14"	PL
43081	7" x 10"	AL
43082	10" x 14"	AL



76065	10" x 14"	FB
84834	10" x 14"	SS
25506	7" x 10"	PL
43083	7" x 10"	AL
43084	10" x 14"	AL



126938	7" x 10"	SS
126941	10" x 14"	SS
126937	7" x 10"	PL
126940	10" x 14"	PL
126936	7" x 10"	AL
126939	10" x 14"	AL



126944	7" x 10"	SS
126947	10" x 14"	SS
126943	7" x 10"	PL
126946	10" x 14"	PL
126942	7" x 10"	AL
126945	10" x 14"	AL



69057	10" x 14"	FB
84837	7" x 10"	SS
84838	10" x 14"	SS



126950	7" x 10"	SS
126953	10" x 14"	SS
126949	7" x 10"	PL
126952	10" x 14"	PL
126948	7" x 10"	AL
126951	10" x 14"	AL



41147	14" x 10"	AL
-------	-----------	----



126956	7" x 10"	SS
126959	10" x 14"	SS
126955	7" x 10"	PL
126958	10" x 14"	PL
126954	7" x 10"	AL
126957	10" x 14"	AL



84843	7" x 10"	SS
84844	10" x 14"	SS



69315	10" x 14"	FB
84847	7" x 10"	SS
84848	10" x 14"	SS
25512	7" x 10"	PL
25513	10" x 14"	PL
43089	7" x 10"	AL
43090	10" x 14"	AL



126962	10" x 7"	SS
126965	14" x 10"	SS
126961	10" x 7"	PL
126964	14" x 10"	PL
126960	10" x 7"	AL
126963	14" x 10"	AL



126968	7" x 10"	SS
126971	10" x 14"	SS
126967	7" x 10"	PL
126970	10" x 14"	PL
126966	7" x 10"	AL
126969	10" x 14"	AL



126974	7" x 10"	SS
126977	10" x 14"	SS
126973	7" x 10"	PL
126976	10" x 14"	PL
126972	7" x 10"	AL
126975	10" x 14"	AL



126980	10" x 7"	SS
126983	14" x 10"	SS
126979	10" x 7"	PL
126982	14" x 10"	PL
126978	10" x 7"	AL
126981	14" x 10"	AL



70533	10" x 14"	FB
84851	7" x 10"	SS
84852	10" x 14"	SS
25515	10" x 14"	PL
43092	10" x 14"	AL



70534	10" x 14"	FB
84853	7" x 10"	SS
25516	7" x 10"	PL
25517	10" x 14"	PL
43094	10" x 14"	AL



84855	7" x 10"	SS
84856	10" x 14"	SS
43095	7" x 10"	AL
43096	10" x 14"	AL



70569	10" x 14"	FB
84857	7" x 10"	SS
25520	7" x 10"	PL
25521	10" x 14"	PL
43097	7" x 10"	AL
43098	10" x 14"	AL



126986	7" x 10"	SS
126989	10" x 14"	SS
126985	7" x 10"	PL
126988	10" x 14"	PL
126984	7" x 10"	AL
126987	10" x 14"	AL



126998	7" x 10"	SS
127001	10" x 14"	SS
126997	7" x 10"	PL
127000	10" x 14"	PL
126996	7" x 10"	AL
126999	10" x 14"	AL



73404	7" x 10"	FB
84933	7" x 10"	SS
84934	10" x 14"	SS
25569	10" x 14"	PL
43145	7" x 10"	AL
43146	10" x 14"	AL



70202	7" x 10"	FB
84929	7" x 10"	SS
25566	7" x 10"	PL
25567	10" x 14"	PL
43143	7" x 10"	AL
43144	10" x 14"	AL



122864	7" x 10"	FB
122726	10" x 14"	FB
84859	7" x 10"	SS
84860	10" x 14"	SS
122530	7" x 10"	PL
122479	10" x 14"	PL
122421	7" x 10"	AL
122355	10" x 14"	AL



71432	14" x 20"	FB
-------	-----------	----

Electrical Hazard Signs (continued)



47195	10" x 14"	FB
89098	7" x 10"	SS
89099	10" x 14"	SS
25530	7" x 10"	PL
25531	10" x 14"	PL
43107	7" x 10"	AL
43108	10" x 14"	AL

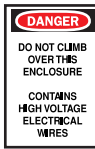

70402	20" x 14"	FB
43363	10" x 7"	AL
43364	14" x 10"	AL



25522	7" x 10"	PL
43099	7" x 10"	AL



25524	7" x 10"	PL
43101	7" x 10"	AL
43102	10" x 14"	AL



84865	7" x 10"	SS
25526	7" x 10"	PL
25527	10" x 14"	PL
43104	10" x 14"	AL



70306	7" x 17"	FB
95687	10" x 14"	SS
25897	10" x 14"	PL
43474	10" x 14"	AL



69192	7" x 17"	FB
-------	----------	----



127004	7" x 10"	SS
127007	10" x 14"	SS
127003	7" x 10"	PL
127006	10" x 14"	PL
127002	7" x 10"	AL
127005	10" x 14"	AL



127016	7" x 10"	SS
127019	10" x 14"	SS
127015	7" x 10"	PL
127018	10" x 14"	PL
127014	7" x 10"	AL
127017	10" x 14"	AL



127010	7" x 10"	SS
127013	10" x 14"	SS
127009	7" x 10"	PL
127012	10" x 14"	PL
127008	7" x 10"	AL
127011	10" x 14"	AL



127022	7" x 10"	SS
127025	10" x 14"	SS
127021	7" x 10"	PL
127024	10" x 14"	PL
127020	7" x 10"	AL
127023	10" x 14"	AL



126992	7" x 10"	SS
126995	10" x 14"	SS
126991	7" x 10"	PL
126994	10" x 14"	PL
126990	7" x 10"	AL
126993	10" x 14"	AL



89173	2.25" x 4.5"	SS
84875	3.5" x 5"	SS



47146	10" x 7"	FB
122788	14" x 10"	FB
84878	10" x 7"	SS
84879	14" x 10"	SS
25534	10" x 7"	PL
122503	14" x 10"	PL
43111	10" x 7"	AL
43112	14" x 10"	AL



71565	7" x 10"	FB
47005	10" x 14"	FB
75590	14" x 20"	FB
71570	20" x 28"	FB
84876	7" x 10"	SS
84877	10" x 14"	SS
25532	7" x 10"	PL
25533	10" x 14"	PL
73540	7" x 10"	BGSS
80204	10" x 14"	BGSS
80269	7" x 10"	BGPL
80270	10" x 14"	BGPL



43109	7" x 10"	AL
43110	10" x 14"	AL



87681	14" x 10"	FB
59382	10" x 7"	SS
19527	14" x 10"	SS
59383	10" x 7"	PL
45427	14" x 10"	PL
59384	10" x 7"	AL
45428	14" x 10"	AL



131703	7" x 10"	FB
131704	10" x 14"	FB
131706	3" x 3"	SS
131705	3" x 5"	SS
131701	7" x 10"	SS
131702	10" x 14"	SS
131699	7" x 10"	PL
131700	10" x 14"	PL
131697	7" x 10"	AL
131698	10" x 14"	AL



95287	7" x 17"	FB
60580	10" x 14"	SS
25900	10" x 14"	PL
43477	10" x 14"	AL



69023	14" x 20"	FB
84883	10" x 14"	SS
25538	7" x 10"	PL
25539	10" x 14"	PL
43115	7" x 10"	AL
43116	10" x 14"	AL



123697	7" x 10"	SS
123700	10" x 14"	SS
123696	7" x 10"	PL
123699	10" x 14"	PL
123695	7" x 10"	AL
123698	10" x 14"	AL



84884	7" x 10"	SS
84885	10" x 14"	SS



70388	7" x 17"	FB
-------	----------	----



87678	7" x 10"	FB
59385	7" x 10"	SS
19837	10" x 14"	SS
59386	7" x 10"	PL
19839	10" x 14"	PL
59387	7" x 10"	AL



76072	10" x 14"	FB
84880	7" x 10"	SS
25537	10" x 14"	PL
43113	7" x 10"	AL
43114	10" x 14"	AL



69026	10" x 14"	FB
84886	7" x 10"	SS
84887	10" x 14"	SS
25540	7" x 10"	PL
25541	10" x 14"	PL
43117	7" x 10"	AL
43118	10" x 14"	AL



70389	7" x 17"	FB
-------	----------	----



69157	10" x 14"	FB
84888	7" x 10"	SS
84889	10" x 14"	SS
43119	7" x 10"	AL
43120	10" x 14"	AL



71572	20" x 14"	FB
25545	14" x 10"	PL
43122	14" x 10"	AL



69024	14" x 20"	FB
84895	7" x 10"	SS
25546	7" x 10"	PL
25547	10" x 14"	PL
43123	7" x 10"	AL
43124	10" x 14"	AL



131713	7" x 10"	FB
131714	10" x 14"	FB
131711	7" x 10"	SS
131712	10" x 14"	SS
131709	7" x 10"	PL
131710	10" x 14"	PL
131707	7" x 10"	AL
131708	10" x 14"	AL

Electrical Hazard Signs

BradyID.com/s36

Electrical Hazard Signs (continued)



69036	10" x 14"	FB
84897	7" x 10"	SS
25548	7" x 10"	PL
25549	10" x 14"	PL
43125	7" x 10"	AL



69035	10" x 14"	FB
25551	10" x 14"	PL
43127	7" x 10"	AL
43128	10" x 14"	AL



69025	10" x 14"	FB
84903	7" x 10"	SS
84904	10" x 14"	SS
25552	7" x 10"	PL
25553	10" x 14"	PL
43129	7" x 10"	AL
43130	10" x 14"	AL



84905	7" x 10"	SS
84906	10" x 14"	SS

Sign Selection Guide

- FB - Premium fiberglass (B-120)
- SS - Self-sticking polyester (B-302)
- PL - Plastic (B-401)
- AL - Aluminum (B-555)
- BGSS - BradyGlo™ self-stick polyester (B-324)
- BGPL - BradyGlo™ plastic (B-347)

Material Comparison page 408
Sign Legend Index..... page 588



87667	7" x 10"	FB
19929	7" x 10"	SS
19935	10" x 14"	SS
19931	7" x 10"	PL
19937	10" x 14"	PL
19932	7" x 10"	AL
19938	10" x 14"	AL



84917	7" x 10"	SS
84918	10" x 14"	SS
69339	10" x 14"	FB
25556	7" x 10"	PL
25557	10" x 14"	PL
43134	10" x 14"	AL



123613	7" x 10"	SS
123616	10" x 14"	SS
123612	7" x 10"	PL
123615	10" x 14"	PL
123611	7" x 10"	AL
123614	10" x 14"	AL



84924	10" x 14"	SS
25560	7" x 10"	PL



59379	7" x 10"	SS
59380	7" x 10"	PL
16953	10" x 14"	PL
59381	7" x 10"	AL
16954	10" x 14"	AL



47169	7" x 10"	FB
84925	7" x 10"	SS
84926	10" x 14"	SS
25562	7" x 10"	PL
25563	10" x 14"	PL
43139	7" x 10"	AL
43140	10" x 14"	AL



127028	7" x 10"	SS
127031	10" x 14"	SS
127027	7" x 10"	PL
127030	10" x 14"	PL
127026	7" x 10"	AL
127029	10" x 14"	AL



47170	7" x 10"	FB
84927	7" x 10"	SS
84928	10" x 14"	SS
25564	7" x 10"	PL
25565	10" x 14"	PL
43141	7" x 10"	AL
43142	10" x 14"	AL



84937	7" x 10"	SS
84938	10" x 14"	SS



127034	7" x 10"	SS
127037	10" x 14"	SS
127033	7" x 10"	PL
127036	10" x 14"	PL
127032	7" x 10"	AL
127035	10" x 14"	AL



127040	7" x 10"	SS
127043	10" x 14"	SS
127039	7" x 10"	PL
127042	10" x 14"	PL
127038	7" x 10"	AL
127041	10" x 14"	AL



69586	10" x 14"	FB
84941	7" x 10"	SS
84942	10" x 14"	SS
22562	7" x 10"	PL
22563	10" x 14"	PL
41126	7" x 10"	AL
41127	10" x 14"	AL



69587	10" x 14"	FB
84943	7" x 10"	SS
84944	10" x 14"	SS
22564	7" x 10"	PL
22565	10" x 14"	PL
41128	7" x 10"	AL
41129	10" x 14"	AL



127046	7" x 10"	SS
127049	10" x 14"	SS
127045	7" x 10"	PL
127048	10" x 14"	PL
127044	7" x 10"	AL
127047	10" x 14"	AL



69613	10" x 14"	FB
84945	7" x 10"	SS
84946	10" x 14"	SS
22566	7" x 10"	PL
22567	10" x 14"	PL
41130	7" x 10"	AL
41131	10" x 14"	AL

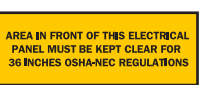

122861	7" x 10"	FB
122723	10" x 14"	FB
84949	3.5" x 10"	SS
122656	7" x 10"	SS
122579	10" x 14"	SS
122527	7" x 10"	PL
122476	10" x 14"	PL
122418	7" x 10"	AL
122352	10" x 14"	AL



122863	7" x 10"	FB
122725	10" x 14"	FB
84950	3.5" x 10"	SS
122580	10" x 14"	SS



71463	5" x 14"	FB
71473	10" x 14"	FB
84956	5" x 14"	SS
84957	7" x 10"	SS
84958	10" x 14"	SS
25771	7" x 10"	PL
25772	10" x 14"	PL
43349	10" x 14"	AL



71479	10" x 14"	FB
84959	7" x 10"	SS
84960	10" x 14"	SS
22569	7" x 10"	PL
22570	10" x 14"	PL
41133	7" x 10"	AL
41134	10" x 14"	AL



84962	3.5" x 10"	SS
-------	------------	----

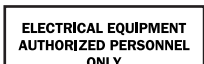

84963	3.5" x 10"	SS
-------	------------	----



69190	10" x 10"	FB
131729	10" x 14"	FB
89152	3" x 3"	SS
88497	10" x 10"	SS
131730	10" x 14"	SS
25162	10" x 14"	PL
42739	10" x 14"	AL



88498	10" x 10"	SS
42740	10" x 14"	AL



69796	7" x 7"	FB
88512	7" x 7"	SS
25176	7" x 10"	PL
42753	7" x 10"	AL



89100	3.5" x 10"	SS
84966	5" x 14"	SS
41136	10" x 14"	AL



71065	14" x 20"	FB
84967	7" x 10"	SS
84968	10" x 14"	SS
41137	7" x 10"	AL

Safety Signs

Exit and Directional Signs

Brady exit signs lead employees to safety in an emergency or guide traffic in your facility. Brady's exit signs are available in standard and photoluminescent materials, with combination lighting and emergency floodlights, as well as exit markings with safety and egress instructions.



40648 10" x 14" AL



127052 7" x 10" SS
127055 10" x 14" SS
127051 7" x 10" PL
127054 10" x 14" PL
127050 7" x 10" AL
127053 10" x 14" AL



73482 7" x 10" FB
71166 10" x 14" FB
84617 7" x 10" SS
84618 10" x 14" SS
25761 7" x 10" PL
25762 10" x 14" PL
43338 7" x 10" AL
43339 10" x 14" AL



127106 7" x 10" SS
127109 10" x 14" SS
127105 7" x 10" PL
127108 10" x 14" PL
127104 7" x 10" AL
127107 10" x 14" AL



84622 3.5" x 14" SS



90491 2.5" x 7" BGSS
80201 3.5" x 10" BGSS
80202 5" x 14" BGSS
80267 3.5" x 10" BGPL
80268 5" x 14" BGPL



84621 1.75" x 10" SS

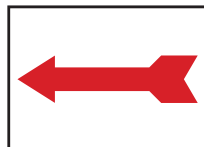

25765 7" x 10" PL
43342 7" x 10" AL



90123 7" x 10" BGSS

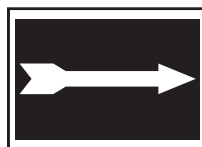

84619 3.5" x 10" SS
25763 7" x 10" PL
43340 7" x 10" AL

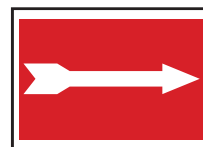

25766 7" x 10" PL
43343 7" x 10" AL



25764 7" x 10" PL
43341 7" x 10" AL



90964 7" x 10" BGPL



59279 6" x 6" BGSS



127088 7" x 10" SS
127091 10" x 14" SS
127087 7" x 10" PL
127090 10" x 14" PL
127086 7" x 10" AL
127089 10" x 14" AL



80272 5" x 14" BGPL



90926 5" x 14" BGPL



132200 7" x 10" FB
132201 10" x 14" FB
123811 7" x 10" SS
123814 10" x 14" SS
123810 7" x 10" PL
123813 10" x 14" PL
123809 7" x 10" AL
123812 10" x 14" AL

Regulations

Not an Exit 1910.37(b)(5)

Any door, passage, or stairway that is not an exit or a way to get to an exit, but looks as though it could be an exit must be marked with a sign reading "NOT AN EXIT," or must be identified by a sign telling what it is, such as "basement," "storeroom," "linen closet," or whatever it may be.

Evacuation Route 1910.38(a)(2), 1910.120(1)(2)(vi) (Informational marking)

Elements of an emergency response plan. The employer shall develop an emergency response plan for emergencies which shall address, as minimum, the following:...(vi) Evacuation routes and procedures.

Exit 1910.37(b)(4)

If the direction of travel to the exit or exit discharge is not immediately apparent, signs must be posted along the exit access indicating the direction of travel to the nearest exit or exit discharge. Additionally, the line-of-sight to an exit sign must clearly be visible at all times.

EXIT 29 CFR 1910.37 (b)(7)

Each exit sign must have the word "Exit" in plainly legible letters not less than 6 inches high, with the principal strokes of the letters in the word "Exit" less than 0.75 inch wide.

Exit and Directional Signs

BradyID.com/s36

Exit and Directional Signs (continued)



132172	7" x 10"	FB
132173	10" x 14"	FB
132174	7" x 10"	SS
132175	10" x 14"	SS
132168	7" x 10"	PL
132169	10" x 14"	PL
132170	7" x 10"	AL
132171	10" x 14"	AL



132156	7" x 10"	FB
132157	10" x 14"	FB
132158	7" x 10"	SS
132159	10" x 14"	SS
132152	7" x 10"	PL
132153	10" x 14"	PL
132154	7" x 10"	AL
132155	10" x 14"	AL



132164	7" x 10"	FB
132165	10" x 14"	FB
132166	7" x 10"	SS
132167	10" x 14"	SS
132160	7" x 10"	PL
132161	10" x 14"	PL
132162	7" x 10"	AL
132163	10" x 14"	AL



90109	7" x 10"	BGSS
90623	10" x 14"	BGSS
90951	7" x 10"	BGPL
90635	10" x 14"	BGPL

Popular Sign Materials

FB - Premium fiberglass (B-120)
SS - Self-sticking polyester (B-302)
BGSS - BradyGlo self-sticking polyester (B-324)
BGPL - BradyGlo plastic (B-347)
PL - Plastic (B-401)
AL - Aluminum (B-555)

Material Guide..... page 408
Sign Legend Index..... page 588



90622	10" x 14"	BGSS
90950	7" x 10"	BGPL
90634	10" x 14"	BGPL



80207	3.5" x 10"	BGSS
80208	5" x 14"	BGSS
80273	3.5" x 10"	BGPL
80274	5" x 14"	BGPL



90494	10" x 14"	BGSS
90495	10" x 14"	BGPL



69199	10" x 14"	FB
84663	7" x 10"	SS
84664	10" x 14"	SS
22481	7" x 10"	PL
22482	10" x 14"	PL
41045	7" x 10"	AL
41046	10" x 14"	AL



90102	7" x 10"	BGSS
90616	10" x 14"	BGSS
90944	7" x 10"	BGPL
90628	10" x 14"	BGPL



132131	7" x 10"	FB
--------	----------	----



70915	5" x 14"	FB
122793	7" x 10"	FB
122705	10" x 14"	FB
84662	5" x 14"	SS
122635	7" x 10"	SS
122565	10" x 14"	SS
22480	7" x 10"	PL
122464	10" x 14"	PL
41044	7" x 10"	AL
122338	10" x 14"	AL



123787	7" x 10"	SS
123790	10" x 14"	SS
123786	7" x 10"	PL
123789	10" x 14"	PL
123785	7" x 10"	AL
123788	10" x 14"	AL



75978	7" x 10"	FB
122757	10" x 14"	FB
89156	3.5" x 10"	SS
84665	7" x 10"	SS
84666	10" x 14"	SS
22483	7" x 10"	PL
22484	10" x 14"	PL
41047	7" x 10"	AL
41048	10" x 14"	AL



80211	3.5" x 10"	BGSS
80212	5" x 14"	BGSS
80277	3.5" x 10"	BGPL
80278	5" x 14"	BGPL



80209	3.5" x 10"	BGSS
80210	5" x 14"	BGSS
80275	3.5" x 10"	BGPL
80276	5" x 14"	BGPL



90924	5" x 14"	BGPL
-------	----------	------



90923	5" x 14"	BGPL
-------	----------	------



84661	6.5" x 14"	SS
22479	10" x 14"	PL
41043	10" x 14"	AL



80213	7" x 10"	BGSS
80214	10" x 14"	BGSS
80279	7" x 10"	BGPL



132180	7" x 10"	FB
132181	10" x 14"	FB
132182	7" x 10"	SS
132183	10" x 14"	SS
132176	7" x 10"	PL
132177	10" x 14"	PL
132178	7" x 10"	AL
132179	10" x 14"	AL



123805	7" x 10"	SS
123808	10" x 14"	SS
123804	7" x 10"	PL
123807	10" x 14"	PL
123803	7" x 10"	AL
123806	10" x 14"	AL



90940	5" x 14"	BGPL
-------	----------	------



90927	5" x 14"	BGPL
-------	----------	------



84667	7" x 10"	SS
22485	7" x 10"	PL
41049	7" x 10"	AL



70923	14" x 20"	FB
84668	7" x 10"	SS
84669	10" x 14"	SS
22486	7" x 10"	PL
41050	7" x 10"	AL



84626	6.5" x 14"	SS
25768	10" x 14"	PL
43345	10" x 14"	AL

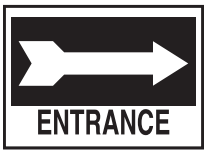

84625	6.5" x 14"	SS
25767	10" x 14"	PL
43344	10" x 14"	AL

Safety Signs

Exit and Directional Signs

BradyID.com/s36

Exit and Directional Signs (continued)



90941 5' x 14' BGPL



70323 6.5' x 14' FB
84670 5' x 14' SS
22487 7' x 10' PL
41051 7' x 10' AL



Meets OSHA 1910.37(b)(7):
73509 7' x 10' BGSS
73510 10' x 14' BGSS
80281 7' x 10' BGPL
80282 10' x 14' BGPL



73558 4' x 9' BGSS



Meets OSHA 1910.37(b)(7):
84675 7' x 10' SS
84676 10' x 14' SS
22491 7' x 10' PL
22492 10' x 14' PL
41055 7' x 10' AL



Meets OSHA 1910.37(b)(7):
47040 7' x 10' FB
47288 10' x 14' FB
84673 7' x 10' SS
84674 10' x 14' SS
22489 7' x 10' PL
22490 10' x 14' PL
41053 7' x 10' AL
41054 10' x 14' AL



80215 7' x 10' BGSS
80283 7' x 10' BGPL
Meets OSHA 1910.37(b)(7):
73513 10' x 14' BGSS
80284 10' x 14' BGPL



95142 7' x 10' B-997



84677 7' x 10' SS
22493 7' x 10' PL
Meets OSHA 1910.37(b)(7):
84678 10' x 14' SS



59329 3' x 6' BGSS
59330 3' x 6' BGPL



70947 7' x 10' FB
84671 7' x 10' SS
22488 7' x 10' PL
41052 7' x 10' AL
Meets OSHA 1910.37(b)(7):
70949 10' x 14' FB
84672 10' x 14' SS



51551 10' x 14' SS
51552 10' x 14' PL
Package includes 6 identical signs.



70976 14' x 20' FB
84679 7' x 10' SS
84680 10' x 14' SS
22494 7' x 10' PL
41058 7' x 10' AL



116077 10' x 14' B-563
116078 7' x 10' B-563



84633 7' x 10' SS
22459 7' x 10' PL
41023 7' x 10' AL
Meets OSHA 1910.37(b)(7):
84634 10' x 14' SS
22460 10' x 14' PL
41024 10' x 14' AL



Meets OSHA 1910.37(b)(7):
80221 10' x 7' BGSS
80222 14' x 10' BGSS
80289 10' x 7' BGPL
80290 14' x 10' BGPL



Meets OSHA 1910.37(b)(7):
80219 10' x 7' BGSS
80220 14' x 10' BGSS
80287 10' x 7' BGPL
80288 14' x 10' BGPL



Meets OSHA 1910.37(b)(7):
80217 10' x 7' BGSS
80218 14' x 10' BGSS
80285 10' x 7' BGPL
80286 14' x 10' BGPL

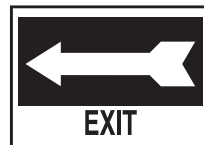

70325 6.5' x 14' FB
84628 6.5' x 14' SS
22454 10' x 14' PL
41018 10' x 14' AL

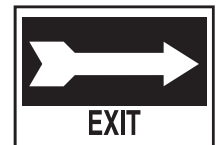

84627 6.5' x 14' SS
22453 10' x 14' PL
41017 10' x 14' AL



47035 7' x 14' FB
76066 10' x 14' FB
122636 7' x 10' SS
84632 10' x 14' SS
22457 7' x 10' PL
22458 10' x 14' PL
41021 7' x 10' AL
41022 10' x 14' AL



47034 7' x 14' FB
76067 10' x 14' FB
122634 7' x 10' SS
84630 10' x 14' SS
22455 7' x 10' PL
22456 10' x 14' PL
41019 7' x 10' AL
41020 10' x 14' AL

Perimeter L.E.D. Exit Signs

- An economical alternative to traditional, incandescent or fluorescent exit signs.
- Listed to UL 924 and in compliance with OSHA, NEC and NFP standard
- Includes a 90-minute nickel cadmium battery back-up assembly for power failure
- Standard input voltages are 120 or 277AC



Catalog #	Description	Color	Size
56905	Perimeter LED Exit Sign	Black / Red	7.5" x 12.25" x 2.5"
56907	Perimeter LED Exit Sign	White / Red	7.5" x 12.25" x 2.5"
56908	Perimeter LED Exit Sign	White / Green	7.5" x 12.25" x 2.5"

Exit and Directional Signs

BradyID.com/s36

Exit and Directional Signs (continued)



90966 7" x 10" BGPL



84685 7" x 10" SS
84686 10" x 14" SS
22499 7" x 10" PL
22500 10" x 14" PL
41063 7" x 10" AL
41064 10" x 14" AL



73542 7" x 10" BGSS
80247 10" x 14" BGSS
85480 7" x 10" BGPL
85481 10" x 14" BGPL

Popular Sign Materials

- FB - Premium fiberglass (B-120)
- SS - Self-sticking polyester (B-302)
- BGSS - BradyGlo self-sticking polyester (B-324)
- BGPL - BradyGlo plastic (B-347)
- PL - Plastic (B-401)
- AL - Aluminum (B-555)

Material Guide..... page 408
Sign Legend Index..... page 588



90105 7" x 10" BGSS
90619 10" x 14" BGSS
90947 7" x 10" BGPL
90631 10" x 14" BGPL



90492 3.5" x 10" BGSS



73545 7" x 10" BGSS
80250 10" x 14" BGSS
85484 7" x 10" BGPL
85523 10" x 14" BGPL



71015 7" x 10" FB
71016 10" x 14" FB
84687 7" x 10" SS
84688 10" x 14" SS
22501 7" x 10" PL
22502 10" x 14" PL
41065 7" x 10" AL
41066 10" x 14" AL



70460 6.5" x 14" FB
84642 6.5" x 14" SS
22466 10" x 14" PL
41030 10" x 14" AL



73417 6.5" x 14" FB
84641 6.5" x 14" SS
22465 10" x 14" PL
41029 10" x 14" AL



84644 6.5" x 14" SS
22468 10" x 14" PL
41032 10" x 14" AL



73467 6.5" x 14" FB
84643 6.5" x 14" SS
22467 10" x 14" PL
41031 10" x 14" AL

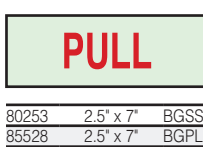

80253 2.5" x 7" BGSS
85528 2.5" x 7" BGPL

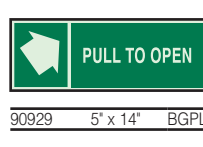

90929 5" x 14" BGPL



90611 5" x 14" BGSS
90939 5" x 14" BGPL

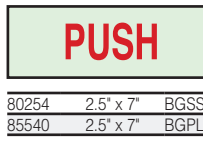

80254 2.5" x 7" BGSS
85540 2.5" x 7" BGPL

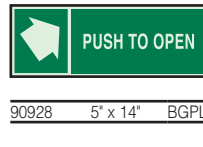

90928 5" x 14" BGPL



84648 6.5" x 14" SS
22470 10" x 14" PL
41034 10" x 14" AL



84647 6.5" x 14" SS
22469 10" x 14" PL
41033 10" x 14" AL



73473 6.5" x 14" FB
22472 10" x 14" PL
41036 10" x 14" AL



70525 6.5" x 14" FB
22471 10" x 14" PL
41035 10" x 14" AL



80255 10" x 14" BGSS
85541 7" x 10" BGPL
85545 10" x 14" BGPL



80261 10" x 14" BGSS
80027 7" x 10" BGPL
80028 10" x 14" BGPL

Safety Signs

Are you prepared if the lights go out?

Brady carries a wide variety of BradyGlo products to support your emergency egress plan. Visit BradyID.com for learning resources and products such as:



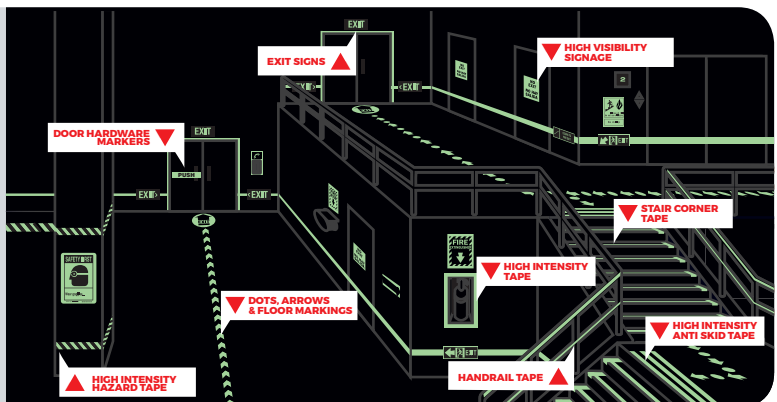













- BradyGlo Marking Tape
- BradyGlo Printable Label Material
- BradyGlo signs













Exit and Directional Signs

BradyID.com/s36

Exit and Directional Signs (continued)

					
90931 5' x 14" BGPL	80259 10' x 14" BGSS 85601 7' x 10" BGPL	80256 7' x 10" BGSS 80257 10' x 14" BGSS 85546 7' x 10" BGPL	127100 7' x 10" SS 127103 10' x 14" SS 127099 7' x 10" PL 127102 10' x 14" PL 127098 7' x 10" AL 127101 10' x 14" AL	90713 7' x 10" BGPL	84689 7' x 10" SS 84690 10' x 14" SS 22503 7' x 10" PL 22504 10' x 14" PL 41067 7' x 10" AL 41068 10' x 14" AL
					
71373 6.5' x 14" FB 84654 6.5' x 14" SS 22476 10' x 14" PL	71366 6.5' x 14" FB 84653 6.5' x 14" SS 22475 10' x 14" PL	80264 3.5' x 10" BGSS 80040 3.5' x 10" BGPL 80041 5' x 14" BGPL	80262 3.5' x 10" BGSS 80029 3.5' x 10" BGPL 80035 5' x 14" BGPL	84652 6.5' x 14" SS 41038 10' x 14" AL	70550 6.5' x 14" FB 84651 6.5' x 14" SS 22473 10' x 14" PL 41037 10' x 14" AL
					
90553 7' x 10" BGSS 90186 10' x 14" BGSS 90717 7' x 10" BGPL	90185 10' x 14" BGSS	87651 7' x 10" FB 59388 7' x 10" SS 59389 7' x 10" PL	59391 7' x 10" SS	80266 2.5' x 7" BGSS 80048 2.5' x 7" BGPL	

Severe Weather Directional Signs

					
132188 7' x 10" FB 132189 10' x 14" FB 132190 7' x 10" SS 132191 10' x 14" SS 132184 7' x 10" PL 132185 10' x 14" PL 132186 7' x 10" AL 132187 10' x 14" AL	127352 7' x 10" SS 127355 10' x 14" SS 127351 7' x 10" PL 127354 10' x 14" PL 127350 7' x 10" AL 127353 10' x 14" AL	75970 7' x 10" FB 75971 10' x 14" FB 84770 7' x 10" SS 84771 10' x 14" SS 22560 7' x 10" PL 22561 10' x 14" PL 41124 7' x 10" AL 41125 10' x 14" AL	90540 14' x 20" FB	127160 10' x 7" SS 127163 14' x 10" SS 127159 10' x 7" PL 127162 14' x 10" PL 127158 10' x 7" AL 127161 14' x 10" AL	90551 10' x 7" BGSS 90184 14' x 10" BGSS 90777 14' x 10" BGPL
					
123799 10' x 7" SS 123802 14' x 10" SS 123798 10' x 7" PL 123801 14' x 10" PL 123797 10' x 7" AL 123800 14' x 10" AL	103595 14' x 10" PL	123793 10' x 7" SS 123796 14' x 10" SS 123792 10' x 7" PL 123795 14' x 10" PL 123791 10' x 7" AL 123794 14' x 10" AL	90550 10' x 7" BGSS 90183 14' x 10" BGSS 90714 10' x 7" BGPL 90776 14' x 10" BGPL		

Safety Signs

Exit and Directional Signs

BradyID.com/s36



BradyGlo™ Exit Signs

- Energy efficient and require no power source. Certified by UL for LED lighting as an acceptable charging source
- Compliant to NFPA Life Safety Code 101 and UL 924 Listed
- Non-electric, non-toxic, non-radioactive
- May qualify for LEED credits

Regulations

UL1994 - Luminous Egress Path Marking Systems

This standard regulates specific materials and testing for photoluminescent egress products for doors, door hardware, door frames, stairs, obstacles, egress symbols and more.

UL 924: Exit Signs are to automatically supply illumination to critical areas in the event of failure of the normal power supply. UL 924 lists photoluminescent exit signs as acceptable to use in place of UL Listed electrical exit signs.

Visibility Options

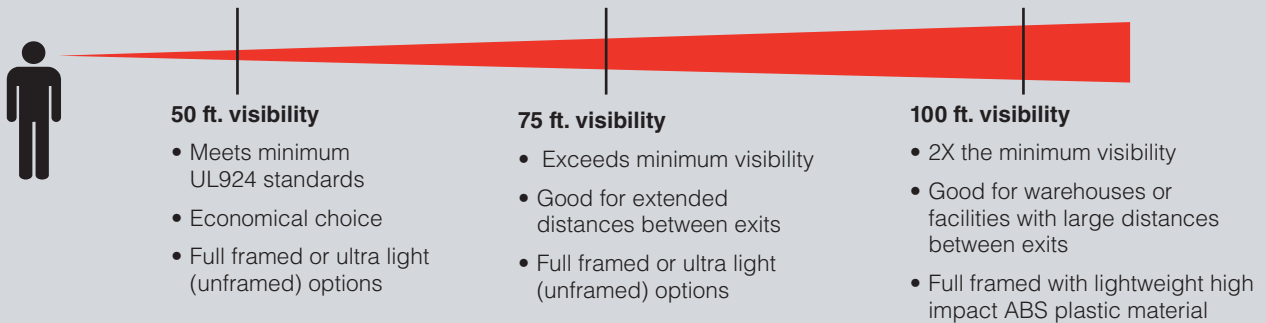

Installation Options



T-Bar mount

T-bar clips allow you to easily mount the sign from drop ceilings.

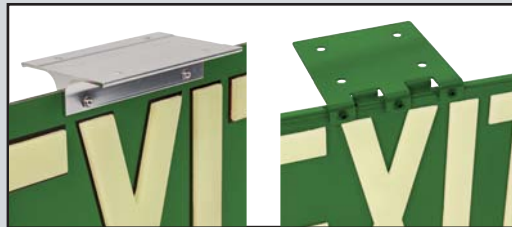

Ultra-light bracket

Full framed bracket

Brackets can be attached to either the top or the side of the sign.

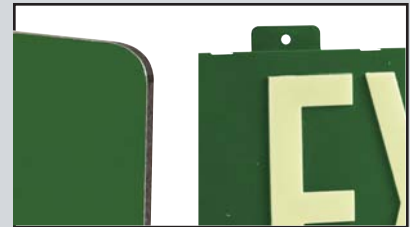

Ultra-light

Full framed

The smooth surface of ultra-light signs accepts various mounting techniques. The full framed signs have two permanent top mounts.

100 ft. Visibility Plastic

- Ideal for warehouses and other facilities with large spans between exits
- Constructed of highly durable, injection molded plastic and UL 924 listed
- Includes two adhesive directional arrows

Visibility	Material	Style	Size	Red	Green	Black
100 ft.	Plastic	Double Sided, Bracket	9.5" x 17.25"	145480	145479	145478
100 ft.	Plastic	Double Sided, T-Bar	9.5" x 17.25"	145483	145482	145481
100 ft.	Plastic	Single Sided, Bracket	9.5" x 17.25"	145474	145473	145472
100 ft.	Plastic	Single Sided, T-Bar	9.5" x 17.25"	145477	145476	145475
100 ft.	Plastic	Wall Mounted	9.5" x 17.25"	145471	145470	145469

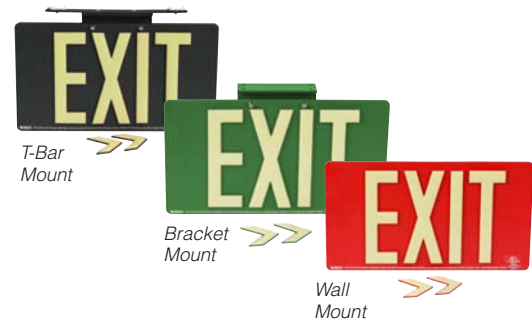

75 ft. Visibility Full Framed

- Ideal for warehouses and other facilities with large spans between exits
- Steel face plate with aluminum photoluminescent letters, UL 924 listed
- Includes two adhesive directional arrows

Visibility	Material	Style	Size	Red	Green	Black
75 ft	Steel Frame	Double Sided, Bracket	8.75" x 15.75"	145495	145494	145493
75 ft	Steel Frame	Double Sided, T-Bar	8.75" x 15.75"	145498	145497	145496
75 ft	Steel Frame	Single Sided, Bracket	8.75" x 15.75"	145489	145488	145487
75 ft	Steel Frame	Single Sided, T-Bar	8.75" x 15.75"	145492	145491	145490
75 ft	Steel Frame	Wall Mounted	8.75" x 15.75"	145486	145485	145484



75 ft. Visibility Ultra-Light Aluminum

- Economical solution for facilities with large spans between exits
- Light weight composite aluminum panel sign, UL 924 listed
- Includes two adhesive directional arrows

Visibility	Material	Style	Size	Red	Green	Black
75 ft	Aluminum	Double Sided, Bracket	9" x 15.75"	145533	145532	145531
75 ft	Aluminum	Double Sided, T-Bar	9" x 15.75"	145536	145535	145534
75 ft	Aluminum	Single Sided, Bracket	9" x 15.75"	145527	145526	145525
75 ft	Aluminum	Single Sided, T-Bar	9" x 15.75"	145530	145529	145528
75 ft	Aluminum	Wall Mounted	9" x 15.75"	145524	145523	145522

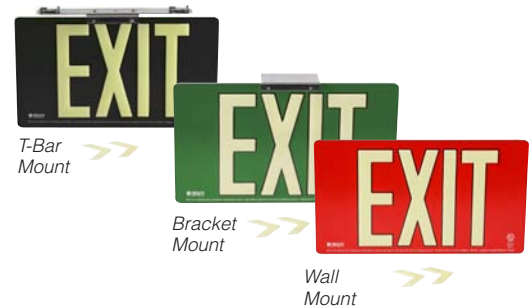

50 ft. Visibility Ultra-Light Aluminum

- Economical solution for minimum compliance
- Light weight composite aluminum panel sign, UL 924 listed
- Includes two adhesive directional arrows

Visibility	Material	Style	Size	Red	Green	Black
50 ft	Aluminum	Double Sided, Bracket	8.5" x 15.5"	145518	145517	145516
50 ft	Aluminum	Double Sided, T-Bar	8.5" x 15.5"	145521	145520	145519
50 ft	Aluminum	Single Sided, Bracket	8.5" x 15.5"	145510	145509	145508
50 ft	Aluminum	Single Sided, T-Bar	8.5" x 15.5"	145515	145514	145513
50 ft	Aluminum	Wall Mounted	8.5" x 15.5"	145501	145500	145499



Exit and Directional Signs

BradyID.com/s36

BradyGlo™ Directional Exit Signs

- Doors opening to corridors where such corridors act as required exit passageways connecting two vertical exits
- Doors serving as horizontal exits or stairwell exits
- Transfer levels and wherever egress direction is not clear

Sign Selection Guide

BGSS - BradyGlo self-sticking polyester (B-523)
BGAL - BradyGlo aluminum (B-552)

Material Guide..... page 408
 Sign Legend Index..... page 588



81919 5" x 14" BGSS 1/pk
 81921 5" x 14" BGSS 10/pk
 81923 5" x 14" BGAL 1/pk
 81925 5" x 14" BGAL 10/pk



81918 5" x 14" BGSS 1/pk
 81920 5" x 14" BGSS 10/pk
 81922 5" x 14" BGAL 1/pk



81810 5" x 14" BGSS 1/pk
 81811 5" x 14" BGSS 10/pk
 81813 5" x 14" BGAL 10/pk



81906 5" x 9" BGSS 1/pk
 81907 5" x 9" BGSS 10/pk
 81908 5" x 9" BGAL 1/pk



81791 5" x 14" BGSS 10/pk
 81792 5" x 14" BGAL 1/pk



81886 5" x 9" BGSS 1/pk
 81887 5" x 9" BGSS 10/pk
 81888 5" x 9" BGAL 1/pk



81794 5" x 14" BGSS 1/pk
 81795 5" x 14" BGSS 10/pk
 81796 5" x 14" BGAL 1/pk
 81797 5" x 14" BGAL 10/pk



81890 5" x 9" BGSS 1/pk
 81891 5" x 9" BGSS 10/pk
 81892 5" x 9" BGAL 1/pk



81806 5" x 14" BGSS 1/pk
 81807 5" x 14" BGSS 10/pk
 81808 5" x 14" BGAL 1/pk
 81809 5" x 14" BGAL 10/pk



81904 5" x 9" BGSS 1/pk
 81902 5" x 9" BGSS 10/pk
 81903 5" x 9" BGAL 10/pk



81814 5" x 14" BGSS 1/pk
 81815 5" x 14" BGSS 10/pk
 81816 5" x 14" BGAL 1/pk



81910 5" x 9" BGSS 1/pk
 81911 5" x 9" BGSS 10/pk
 81912 5" x 9" BGAL 1/pk
 81913 5" x 9" BGAL 10/pk



81818 5" x 14" BGSS 1/pk
 81819 5" x 14" BGSS 10/pk
 81820 5" x 14" BGAL 1/pk



81914 5" x 9" BGSS 1/pk
 81915 5" x 9" BGSS 10/pk
 81916 5" x 9" BGAL 1/pk



81798 5" x 14" BGSS 1/pk
 81799 5" x 14" BGSS 10/pk
 81800 5" x 14" BGAL 1/pk
 81801 5" x 14" BGAL 10/pk



81894 5" x 9" BGSS 1/pk
 81895 5" x 9" BGSS 10/pk
 81896 5" x 9" BGAL 1/pk



81802 5" x 14" BGSS 1/pk
 81803 5" x 14" BGSS 10/pk
 81804 5" x 14" BGAL 1/pk
 81805 5" x 14" BGAL 10/pk



81898 5" x 9" BGSS 1/pk
 81899 5" x 9" BGSS 10/pk
 81900 5" x 9" BGAL 1/pk



81831 7" x 18" BGSS 10/pk
 81830 14" x 18" BGSS 1/pk



81822 7" x 18" BGSS 1/pk
 81823 14" x 18" BGSS 10/pk
 81824 7" x 18" BGAL 1/pk



81826 7" x 18" BGSS 1/pk
 81827 7" x 18" BGSS 10/pk
 81828 7" x 18" BGAL 1/pk



81879 10" x 7" BGSS 10/pk



81843 7" x 18" BGSS 10/pk
 81842 14" x 18" BGSS 1/pk
 81845 7" x 18" BGAL 10/pk



81835 7" x 18" BGSS 10/pk
 81834 14" x 18" BGSS 1/pk



81838 14" x 18" BGSS 1/pk
 81839 7" x 18" BGSS 10/pk
 81840 7" x 18" BGAL 1/pk



81882 10" x 7" BGSS 1/pk
 81883 10" x 7" BGSS 10/pk
 81884 10" x 7" BGAL 1/pk

Safety Signs

BradyGlo™ Exit Signs

- Compliant to NFPA Life Safety Code 101, 2015 IBC Regulation and current building codes
- Energy efficient, non-electric, non-toxic, non-radioactive and may qualify for LEED credits
- 50 ft. visibility, 100% reliable and virtually maintenance free
- 3 configurations which can be attached on a surface, ceiling or flag mounted



Frameless exit signs

Catalog #	Description	Size	Color
87807B	Frameless Exit Sign*	8.5" x 15"	Red
87808B	Frameless Exit Sign*	8.5" x 15"	Green

* Includes 2 chevron arrows



Framed single face wall mount sign with hanging tabs

Catalog #	Description	Size	Color
Red	Single / Wall Mount	8.25" x 15.25"	Black
Green	Single / Wall Mount	8.25" x 15.25"	Red
90887B	Single / Wall Mount	8.25" x 15.25"	Green
80753B	Single / Wall Mount	8.25" x 15.25"	White
112653B	Single / Wall Mount	8.25" x 15.25"	Silver



Framed double face sign with bracket

Catalog #	Description	Size	Color
38097B	Single w/ Bracket	8.25" x 15.25"	Black
90839B	Single w/ Bracket	8.25" x 15.25"	Red
90841B	Single w/ Bracket	8.25" x 15.25"	Green
80754B	Single w/ Bracket	8.25" x 15.25"	White
112654B	Single w/ Bracket	8.25" x 15.25"	Silver
38098B	Double w/ Bracket	8.25" x 15.25"	Black
90840B	Double w/ Bracket	8.25" x 15.25"	Red
90842B	Double w/ Bracket	8.25" x 15.25"	Green
80755B	Double w/ Bracket	8.25" x 15.25"	White
112655B	Double w/ Bracket	8.25" x 15.25"	Silver
38099B	Extra Mounting Bracket		Black
90886B	Extra Mounting Bracket		Red
90888B	Extra Mounting Bracket		Green
80756B	Extra Mounting Bracket		White
112656B	Extra Mounting Bracket		Silver



BradyGlo Kick Plate Exit Sign

Catalog #	Description	Size
113063B	Kick Plate Exit Sign	10" x 34"

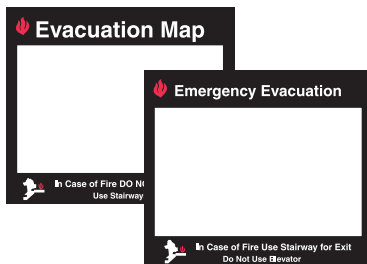

Evacuation Frames

- Holders display your custom evacuation maps
- Clear acrylic frames hold your custom maps and allow you to easily change them when updates are needed

Catalog #	Description	Size	Material
102851	Evacuation Map	11.5" X 11"	Luminous
102852	Evacuation Map	17.5" X 15"	Standard
102853	Evacuation Map	17.5" X 15"	Luminous
102857	Emergency Evacuation	17.5" X 15"	Luminous



Evacuation Map Display Holder

- Easy-to-see acrylic board
- Quickly shows viewers the best evacuation route from their work area

Catalog #	Description	Size
45381	Evacuation Map Display Holder	15" x 11"



Evacuation Plan Holder

- Simply print and insert your map
- Accommodates 17 in. x 11 in. insert
- Non-glare, scratch-resistant finish
- Red border with raised white lettering
- 2 adhesive mounting strips on back

Catalog #	Description	Size
102849	Evacuation Plan Insert Holder	17.5" x 13.5"

Evacuation Assembly / Muster Point Signs

BradyID.com/s36

Evacuation Assembly / Muster Point Signs

During an emergency, it is imperative for employees and visitors to know where to congregate safely. Make sure these designated areas are clearly marked in order to communicate to everyone in your facility.

Brady's Muster Point, Assembly Point, and Evacuation Point signs are designed with ISO approved pictogram for assembly points and help keep your facility up to code.

Sign Selection Guide

- FB** - Premium fiberglass (B-120)
- SS** - Self-sticking polyester (B-302)
- PL** - Plastic (B-401)
- AL** - Aluminum (B-555)
- BGSS** - BradyGlo™ self-stick polyester (B-324)
- BGPL** - BradyGlo™ plastic (B-347)

Material Comparison page 408
Sign Legend Index..... page 588



139559	10" x 14"	FB
139560	14" x 20"	FB
139561	18" x 24"	FB
139562	10" x 14"	PL
139563	14" x 20"	PL
139564	18" x 24"	PL
139565	10" x 14"	AL
139566	14" x 20"	AL
139567	18" x 24"	AL



139622	10" x 14"	FB
139623	14" x 20"	FB
139624	18" x 24"	FB
139625	10" x 14"	PL
139626	14" x 20"	PL
139627	18" x 24"	PL
139628	10" x 14"	AL
139629	14" x 20"	AL
139630	18" x 24"	AL



139577	10" x 14"	FB
139578	14" x 20"	FB
139579	18" x 24"	FB
139580	10" x 14"	PL
139581	14" x 20"	PL
139582	18" x 24"	PL
139583	10" x 14"	AL
139584	14" x 20"	AL
139585	18" x 24"	AL



139640	10" x 14"	FB
139641	14" x 20"	FB
139642	18" x 24"	FB
139643	10" x 14"	PL
139644	14" x 20"	PL
139645	18" x 24"	PL
139646	10" x 14"	AL
139647	14" x 20"	AL
139648	18" x 24"	AL



139595	10" x 14"	FB
139596	14" x 20"	FB
139597	18" x 24"	FB
139598	10" x 14"	PL
139599	14" x 20"	PL
139600	18" x 24"	PL
139601	10" x 14"	AL
139602	14" x 20"	AL
139603	18" x 24"	AL



139649	10" x 14"	FB
139650	14" x 20"	FB
139651	18" x 24"	FB
139652	10" x 14"	PL
139653	14" x 20"	PL
139654	18" x 24"	PL
139655	10" x 14"	AL
139656	14" x 20"	AL
139657	18" x 24"	AL



139604	10" x 14"	FB
139605	14" x 20"	FB
139606	18" x 24"	FB
139607	10" x 14"	PL
139608	14" x 20"	PL
139609	18" x 24"	PL
139610	10" x 14"	AL
139611	14" x 20"	AL
139612	18" x 24"	AL



139631	10" x 14"	FB
139632	14" x 20"	FB
139633	18" x 24"	FB
139634	10" x 14"	PL
139635	14" x 20"	PL
139636	18" x 24"	PL
139637	10" x 14"	AL
139638	14" x 20"	AL
139639	18" x 24"	AL



139586	10" x 14"	FB
139587	14" x 20"	FB
139588	18" x 24"	FB
139589	10" x 14"	PL
139590	14" x 20"	PL
139591	18" x 24"	PL
139592	10" x 14"	AL
139593	14" x 20"	AL
139594	18" x 24"	AL



139613	10" x 14"	FB
139614	14" x 20"	FB
139615	18" x 24"	FB
139616	10" x 14"	PL
139617	14" x 20"	PL
139618	18" x 24"	PL
139619	10" x 14"	AL
139620	14" x 20"	AL
139621	18" x 24"	AL



139568	10" x 14"	FB
139569	14" x 20"	FB
139570	18" x 24"	FB
139571	10" x 14"	PL
139572	14" x 20"	PL
139573	18" x 24"	PL
139574	10" x 14"	AL
139575	14" x 20"	AL
139576	18" x 24"	AL



139658	10" x 14"	FB
139659	14" x 20"	FB
139660	18" x 24"	FB
139661	10" x 14"	PL
139662	14" x 20"	PL
139663	18" x 24"	PL
139664	10" x 14"	AL
139665	14" x 20"	AL
139666	18" x 24"	AL



139667	10" x 14"	FB
139668	14" x 20"	FB
139669	18" x 24"	FB
139670	10" x 14"	PL
139671	14" x 20"	PL
139672	18" x 24"	PL
139673	10" x 14"	AL
139674	14" x 20"	AL
139675	18" x 24"	AL



139676	10" x 14"	FB
139677	14" x 20"	FB
139678	18" x 24"	FB
139679	10" x 14"	PL
139680	14" x 20"	PL
139681	18" x 24"	PL
139682	10" x 14"	AL
139683	14" x 20"	AL
139684	18" x 24"	AL



139685	10" x 14"	FB
139686	14" x 20"	FB
139687	18" x 24"	FB
139688	10" x 14"	PL
139689	14" x 20"	PL
139690	18" x 24"	PL
139691	10" x 14"	AL
139692	14" x 20"	AL
139693	18" x 24"	AL



139694	10" x 14"	FB
139695	14" x 20"	FB
139696	18" x 24"	FB
139697	10" x 14"	PL
139698	14" x 20"	PL
139699	18" x 24"	PL
139700	10" x 14"	AL
139703	14" x 20"	AL
139704	18" x 24"	AL



139705	10" x 14"	FB
139706	14" x 20"	FB
139707	18" x 24"	FB
139708	10" x 14"	PL
139709	14" x 20"	PL
139710	18" x 24"	PL
139711	10" x 14"	AL
139712	14" x 20"	AL
139713	18" x 24"	AL



139714	10" x 14"	FB
139715	14" x 20"	FB
139716	18" x 24"	FB
139717	10" x 14"	PL
139718	14" x 20"	PL
139719	18" x 24"	PL
139720	10" x 14"	AL
139721	14" x 20"	AL
139722	18" x 24"	AL



139723	10" x 14"	FB
139724	14" x 20"	FB
139725	18" x 24"	FB
139726	10" x 14"	PL
139727	14" x 20"	PL
139728	18" x 24"	PL
139729	10" x 14"	AL
139730	14" x 20"	AL
139731	18" x 24"	AL

Safety Signs

International Maritime Organization (IMO) Evacuation Signs

Brady IMO signs are designed to meet the needs of the marine and shipping industry. In the event of an emergency, these signs help warn, instruct and advise passengers of proper evacuation procedures on the vessel. These IMO signs are highly visible to help facilitate a safe and efficient onboard ship evacuation and comply with the IMO resolution A.752 (18).



Fire Safety Signs

BradyID.com/s36

Fire Safety Signs

Brady fire signs help you quickly identify fire exits, fire extinguishers and other fire suppression equipment in your facility. With exit standard red / white and glow-in-the-dark fire signs, you can clearly indicate flammable materials and mark your entire facility for emergency safety.

Sign Selection Guide

- FB** - Premium fiberglass (B-120)
- SS** - Self-sticking polyester (B-302)
- PL** - Plastic (B-401)
- AL** - Aluminum (B-555)
- BGSS** - BradyGlo™ self-stick polyester (B-324)
- BGPL** - BradyGlo™ plastic (B-347)

Material Comparison page 408
Sign Legend Index..... page 588



73458	10' x 14'	FB
89104	7' x 10'	SS
89105	10' x 14'	SS
25640	7' x 10'	PL
25641	10' x 14'	PL
43217	7' x 10'	AL
43218	10' x 14'	AL



89106	7' x 10'	SS
89107	10' x 14'	SS
25642	7' x 10'	PL
25643	10' x 14'	PL
43220	10' x 14'	AL



89110	7' x 10'	SS
85148	10' x 14'	SS
25644	7' x 10'	PL
25645	10' x 14'	PL
43221	7' x 10'	AL
43222	10' x 14'	AL



70225	14' x 20'	FB
85151	7' x 10'	SS
85152	10' x 14'	SS
25646	7' x 10'	PL
25647	10' x 14'	PL
43223	7' x 10'	AL
43224	10' x 14'	AL



73440	10' x 14'	FB
86033	7' x 10'	SS
86034	10' x 14'	SS
23215	7' x 10'	PL
23216	10' x 14'	PL
41889	7' x 10'	AL
41890	10' x 14'	AL



85197	7' x 10'	SS
85198	10' x 14'	SS
25676	7' x 10'	PL
25677	10' x 14'	PL
43254	10' x 14'	AL



69511	10' x 14'	FB
85199	7' x 10'	SS
85200	10' x 14'	SS
25678	7' x 10'	PL
25679	10' x 14'	PL
43255	7' x 10'	AL
43256	10' x 14'	AL



71715	14' x 20'	FB
85294	10' x 14'	SS
22688	7' x 10'	PL
22689	10' x 14'	PL
41252	7' x 10'	AL
41253	10' x 14'	AL

Regulations

Flammable: Keep Fire Away 1910.106(d)(3)(ii)

Storage cabinets in which you keep flammable liquids, such as gasoline, must be labeled in conspicuous lettering, "Flammable - Keep Fire Away."

Fire Extinguisher Marking 1910.157(c)(1)

If you are using portable fire extinguishers, you must mount, locate and identify them so that they are readily accessible to employees.

Fire Hose 1910.158(c)(1)

Where reels or cabinets are provided to contain fire hose, the employer must be sure that they are conspicuously identified and used only for fire equipment.



122832	7' x 10'	FB
71708	10' x 14'	FB
122651	7' x 10'	SS
85206	10' x 14'	SS
25680	7' x 10'	PL
25681	10' x 14'	PL
43257	7' x 10'	AL
43258	10' x 14'	AL



127346	7' x 10'	SS
127349	10' x 14'	SS
127345	7' x 10'	PL
127348	10' x 14'	PL
127344	7' x 10'	AL
127347	10' x 14'	AL



70410	10' x 14'	FB
85639	10' x 14'	SS
22798	7' x 10'	PL
22799	10' x 14'	PL
41362	7' x 10'	AL



85209	7' x 10'	SS
85210	10' x 14'	SS



80007	10' x 14'	SS
80017	10' x 14'	PL
80009	10' x 14'	AL



127358	7' x 10'	SS
127361	10' x 14'	SS
127357	7' x 10'	PL
127360	10' x 14'	PL
127356	7' x 10'	AL
127359	10' x 14'	AL



127370	7' x 10'	SS
127373	10' x 14'	SS
127369	7' x 10'	PL
127372	10' x 14'	PL
127368	7' x 10'	AL
127371	10' x 14'	AL



69582	10' x 14'	FB
85219	7' x 10'	SS
85220	10' x 14'	SS
25690	7' x 10'	PL
25691	10' x 14'	PL
43267	7' x 10'	AL
43268	10' x 14'	AL



69583	10' x 14'	FB
85221	7' x 10'	SS
85222	10' x 14'	SS
25692	7' x 10'	PL
25693	10' x 14'	PL
43269	7' x 10'	AL



127364	7' x 10'	SS
127367	10' x 14'	SS
127363	7' x 10'	PL
127366	10' x 14'	PL
127362	7' x 10'	AL
127365	10' x 14'	AL

Fire Safety Signs (continued)



127112	7" x 10"	SS
127115	10" x 14"	SS
127111	7" x 10"	PL
127114	10" x 14"	PL
127110	7" x 10"	AL
127113	10" x 14"	AL



127118	7" x 10"	SS
127121	10" x 14"	SS
127117	7" x 10"	PL
127120	10" x 14"	PL
127116	7" x 10"	AL
127119	10" x 14"	AL



127136	7" x 10"	SS
127139	10" x 14"	SS
127135	7" x 10"	PL
127138	10" x 14"	PL
127134	7" x 10"	AL
127137	10" x 14"	AL



127124	7" x 10"	SS
127127	10" x 14"	SS
127123	7" x 10"	PL
127126	10" x 14"	PL
127122	7" x 10"	AL
127125	10" x 14"	AL



127130	7" x 10"	SS
127133	10" x 14"	SS
127129	7" x 10"	PL
127132	10" x 14"	PL
127128	7" x 10"	AL
127131	10" x 14"	AL



127142	7" x 10"	SS
127145	10" x 14"	SS
127141	7" x 10"	PL
127144	10" x 14"	PL
127140	7" x 10"	AL
127143	10" x 14"	AL



85225	10" x 14"	SS
43272	10" x 14"	AL



90103	7" x 10"	BGSS
90617	10" x 14"	BGSS
90629	10" x 14"	BGPL



85228	5" x 14"	SS
-------	----------	----



69168	10" x 14"	FB
85231	10" x 14"	SS
25696	7" x 10"	PL
43274	10" x 14"	AL



127148	7" x 10"	SS
127151	10" x 14"	SS
127147	7" x 10"	PL
127150	10" x 14"	PL
127146	7" x 10"	AL
127149	10" x 14"	AL



127166	7" x 10"	SS
127169	10" x 14"	SS
127165	7" x 10"	PL
127168	10" x 14"	PL
127164	7" x 10"	AL
127167	10" x 14"	AL



127154	7" x 10"	SS
127157	10" x 14"	SS
127153	7" x 10"	PL
127156	10" x 14"	PL
127152	7" x 10"	AL
127155	10" x 14"	AL

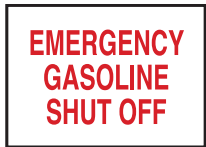

85236	7" x 10"	SS
85237	10" x 14"	SS
25700	7" x 10"	PL
25701	10" x 14"	PL
43277	7" x 10"	AL
43278	10" x 14"	AL



69202	10" x 14"	FB
85239	10" x 14"	SS
25702	7" x 10"	PL
43279	7" x 10"	AL



51545	10" x 14"	AL
-------	-----------	----



122870	7" x 10"	FB
122731	10" x 14"	FB
90372	7" x 10"	SS
122585	10" x 14"	SS
122535	7" x 10"	PL
122481	10" x 14"	PL
122426	7" x 10"	AL
122360	10" x 14"	AL



69206	24" x 4"	FB
85240	14" x 5"	SS
25703	14" x 10"	PL



85241	7" x 10"	SS
85242	10" x 14"	SS
25704	7" x 10"	PL
25705	10" x 14"	PL
43281	7" x 10"	AL
43282	10" x 14"	AL



95504	10" x 14"	AL
95505	14" x 20"	AL



127178	7" x 10"	SS
127181	10" x 14"	SS
127177	7" x 10"	PL
127180	10" x 14"	PL
127176	7" x 10"	AL
127179	10" x 14"	AL



127172	7" x 10"	SS
127175	10" x 14"	SS
127171	7" x 10"	PL
127174	10" x 14"	PL
127170	7" x 10"	AL
127173	10" x 14"	AL



90379	3.5" x 3.5"	SS
-------	-------------	----



47273	7" x 10"	FB
85243	7" x 10"	SS
85244	10" x 14"	SS
25706	7" x 10"	PL
25707	10" x 14"	PL
43283	7" x 10"	AL
43284	10" x 14"	AL



80224	5" x 7"	BGSS
-------	---------	------



127184	7" x 10"	SS
127187	10" x 14"	SS
127183	7" x 10"	PL
127186	10" x 14"	PL
127182	7" x 10"	AL
127185	10" x 14"	AL



Fire Safety Signs

BradyID.com/s36

Fire Safety Signs (continued)



127190	7" x 10"	SS
127193	10" x 14"	SS
127189	7" x 10"	PL
127192	10" x 14"	PL
127188	7" x 10"	AL
127191	10" x 14"	AL



127340	7" x 10"	SS
127343	10" x 14"	SS
127339	7" x 10"	PL
127342	10" x 14"	PL
127338	7" x 10"	AL
127341	10" x 14"	AL



122873	7" x 10"	FB
69071	14" x 10"	FB
122665	7" x 10"	SS
86090	14" x 10"	SS
80161	14" x 10"	BGSS
122538	7" x 10"	PL
25708	14" x 10"	PL
122429	7" x 10"	AL
43285	14" x 10"	AL
95147	14" x 10"	B-997



103599	14" x 3.5"	SS
90366	14" x 5"	SS
103598	14" x 3.5"	BGSS
80223	14" x 5"	BGSS

Sign Selection Guide

- FB** - Premium fiberglass (B-120)
- SS** - Self-sticking polyester (B-302)
- PL** - Plastic (B-401)
- AL** - Aluminum (B-555)
- BGSS** - BradyGlo™ self-stick polyester (B-324)
- BGPL** - BradyGlo™ plastic (B-347)

Material Comparison page 408
Sign Legend Index..... page 588



90976	5" x 14"	BGPL
-------	----------	------



90376	14" x 5"	SS
-------	----------	----



127196	7" x 10"	SS
127199	10" x 14"	SS
127195	7" x 10"	PL
127198	10" x 14"	PL
127194	7" x 10"	AL
127197	10" x 14"	AL



51546	10" x 14"	AL
-------	-----------	----



123775	10" x 7"	SS
123778	14" x 10"	SS
123774	10" x 7"	PL
123777	14" x 10"	PL
123773	10" x 7"	AL
123776	14" x 10"	AL



85248	7" x 10"	SS
85249	10" x 14"	SS
25709	7" x 10"	PL
25710	10" x 14"	PL
43286	7" x 10"	AL
43287	10" x 14"	AL



127226	7" x 10"	SS
127229	10" x 14"	SS
127225	7" x 10"	PL
127228	10" x 14"	PL
127224	7" x 10"	AL
127227	10" x 14"	AL



90100	7" x 10"	BGSS
90942	7" x 10"	BGPL
90626	10" x 14"	BGPL



90101	7" x 10"	BGSS
90943	7" x 10"	BGPL
90627	10" x 14"	BGPL



132148	7" x 10"	FB
132149	10" x 14"	FB
132150	7" x 10"	SS
132151	10" x 14"	SS
132144	7" x 10"	PL
132145	10" x 14"	PL
132146	7" x 10"	AL
132147	10" x 14"	AL



127214	7" x 10"	SS
127217	10" x 14"	SS
127213	7" x 10"	PL
127216	10" x 14"	PL
127212	7" x 10"	AL
127215	10" x 14"	AL



85253	7" x 10"	SS
85254	10" x 14"	SS
25711	7" x 10"	PL
25712	10" x 14"	PL
43288	7" x 10"	AL
43289	10" x 14"	AL



90377	14" x 5"	SS
-------	----------	----



90625	10" x 14"	BGSS
90637	10" x 14"	BGPL
90953	10" x 14"	BGPL



90952	7" x 10"	BGPL
90636	10" x 14"	BGPL



84681	3.5" x 14"	SS
80225	3.5" x 10"	BGSS
80294	3.5" x 10"	BGPL
22495	10" x 14"	PL
41059	10" x 14"	AL



90946	7" x 10"	BGPL
90630	10" x 14"	BGPL



127232	7" x 10"	SS
127235	10" x 14"	SS
127231	7" x 10"	PL
127234	10" x 14"	PL
127230	7" x 10"	AL
127233	10" x 14"	AL



132140	7" x 10"	FB
132141	10" x 14"	FB
132142	7" x 10"	SS
132143	10" x 14"	SS
132136	7" x 10"	PL
132137	10" x 14"	PL
132138	7" x 10"	AL
132139	10" x 14"	AL







84682	7" x 10"	SS
84683	10" x 14"	SS
22496	7" x 10"	PL
22497	10" x 14"	PL
41060	7" x 10"	AL
41061	10" x 14"	AL







80229	3.5" x 10"	BGSS
80298	3.5" x 10"	BGPL
80299	5" x 14"	BGPL





Safety Signs



Fire Safety Signs (continued)







			
80233 3.5" x 10" BGSS 80234 5" x 14" BGSS	47247 3.5" x 14" FB 84635 3.5" x 14" SS 22461 7" x 10" PL 41025 7" x 10" AL	80227 3.5" x 10" BGSS 80296 3.5" x 10" BGPL 80297 5" x 14" BGPL	80231 3.5" x 10" BGSS 80232 5" x 14" BGSS







			
84636 3.5" x 14" SS 22462 7" x 10" PL 41026 7" x 10" AL	71649 5" x 14" FB 85256 3.5" x 10" SS 85257 5" x 14" SS 80235 3.5" x 10" BGSS 80167 3.5" x 10" BGPL	122892 7" x 10" FB 122752 10" x 14" FB 122688 7" x 10" SS 122610 10" x 14" SS 25714 7" x 10" PL 122491 10" x 14" PL 43291 7" x 10" AL 122377 10" x 14" AL	71643 5" x 14" FB 85255 5" x 14" SS 25713 7" x 10" PL 43290 7" x 10" AL



			
91020 7" x 10" BGSS	123769 10" x 7" SS 123772 14" x 10" SS 123768 10" x 7" PL 123771 14" x 10" PL 123767 10" x 7" AL 123770 14" x 10" AL	69246 10" x 14" FB 85262 7" x 10" SS 85263 10" x 14" SS 25719 7" x 10" PL 25720 10" x 14" PL 43297 10" x 14" AL	123757 10" x 7" SS 123760 14" x 10" SS 124567 18" x 4" SS 123756 10" x 7" PL 123759 14" x 10" PL 124566 18" x 4" PL 123755 10" x 7" AL 123758 14" x 10" AL

	
124565 18" x 4" AL	51555 18" x 4" SS Vinyl 51556 18" x 4" PL <i>Package includes 6 identical signs.</i>

					
90371 7" x 10" SS	85264 7" x 10" SS 85265 10" x 14" SS	86092 14" x 10" SS 25721 10" x 14" PL 43298 10" x 14" AL	80242 5" x 14" BGSS	85267 3.5" x 10" SS 85268 5" x 14" SS	127202 7" x 10" SS 127205 10" x 14" SS 127201 7" x 10" PL 127204 10" x 14" PL 127200 7" x 10" AL 127203 10" x 14" AL

					
73433 5" x 14" FB 85269 5" x 14" SS 25722 7" x 10" PL 43299 7" x 10" AL	127208 7" x 10" SS 127211 10" x 14" SS 127207 7" x 10" PL 127210 10" x 14" PL 127206 7" x 10" AL 127209 10" x 14" AL	122790 10" x 7" FB 122702 14" x 10" FB 122632 10" x 7" SS 90383 14" x 10" SS 122463 14" x 10" PL 122392 10" x 7" AL 122337 14" x 10" AL	123781 10" x 7" SS 123784 14" x 10" SS 123780 10" x 7" PL 123783 14" x 10" PL 123779 10" x 7" AL 123782 14" x 10" AL	69243 7" x 7" FB 88504 7" x 7" SS 25169 7" x 10" PL 42746 7" x 10" AL	123763 10" x 7" SS 123766 14" x 10" SS 123762 10" x 7" PL 123765 14" x 10" PL 123761 10" x 7" AL 123764 14" x 10" AL

Fire Safety Signs

BradyID.com/s36

Fire Safety Signs (continued)



124570	18" x 4"	SS
124569	18" x 4"	PL
124568	18" x 4"	AL



90373	7" x 10"	SS
-------	----------	----



47039	14" x 3.5"	FB
71655	24" x 4"	FB
85261	14" x 3.5"	SS
90367	14" x 5"	SS
103597	14" x 3.5"	BGSS
80241	14" x 5"	BGSS
80460	14" x 5"	BGPL



122775	10" x 7"	FB
122710	14" x 10"	FB
122627	10" x 7"	SS
122570	14" x 10"	SS
122471	14" x 10"	PL
25718	10" x 7"	PL
43295	10" x 7"	AL
122345	14" x 10"	AL

Sign Selection Guide

- FB** - Premium fiberglass (B-120)
- SS** - Self-sticking polyester (B-302)
- PL** - Plastic (B-401)
- AL** - Aluminum (B-555)
- BGSS** - BradyGlo™ self-stick polyester (B-324)
- BGPL** - BradyGlo™ plastic (B-347)

Material Comparison page 408
Sign Legend Index..... page 588



69074	14" x 10"	FB
86091	14" x 10"	SS
80162	14" x 10"	BGSS
80174	14" x 10"	BGPL
25717	14" x 10"	PL
43294	14" x 10"	AL
95146	14" x 10"	B-997

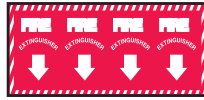

90369	14" x 28"	SS
-------	-----------	----

When wrapped around columns the word "Fire Extinguisher" is repeated 4 times.
Or can be cut into four 14" x 7" single signs.



90975	5" x 14"	BGPL
-------	----------	------



25914	10" x 14"	PL
43491	10" x 14"	AL



78260	14" x 10"	BGSS
80173	14" x 10"	BGPL



85258	3.5" x 14"	SS
25715	7" x 10"	PL
43292	7" x 10"	AL



85259	3.5" x 14"	SS
25716	7" x 10"	PL
43293	7" x 10"	AL



80237	3.5" x 10"	BGSS
-------	------------	------



90560	5" x 14"	BGSS
-------	----------	------



80243	5" x 14"	BGSS
47279	3.5" x 10"	FB
71688	5" x 14"	FB
85275	3.5" x 10"	SS
85276	5" x 14"	SS
43305	7" x 10"	AL



122794	7" x 10"	FB
73434	10" x 14"	FB
85277	7" x 10"	SS
85278	10" x 14"	SS
25729	7" x 10"	PL
122466	10" x 14"	PL
43306	7" x 10"	AL
122340	10" x 14"	AL



91031	7" x 10"	BGSS
-------	----------	------



88505	7" x 7"	SS
25170	7" x 10"	PL
42747	7" x 10"	AL



127220	7" x 10"	SS
127223	10" x 14"	SS
127219	7" x 10"	PL
127222	10" x 14"	PL
127218	7" x 10"	AL
127221	10" x 14"	AL



122706	10" x 14"	FB
122566	10" x 14"	SS
122465	10" x 14"	PL
122339	10" x 14"	AL



122774	10" x 7"	FB
122626	10" x 7"	SS
25723	10" x 7"	PL
43300	10" x 7"	AL



73483	24" x 4"	FB
85270	14" x 5"	SS
80244	14" x 5"	BGSS
85476	14" x 5"	BGPL



90384	14" x 10"	SS
-------	-----------	----

Fire-Changeable Arrow Sign

Self-sticking arrow and sign offers the flexibility to place arrow in desired direction

Catalog #	Size	Description
70855	12" x 9"	Fiberglass Sign and Arrow
89149	12" x 9"	Self-Sticking Sign and Arrow
43355	14" x 10"	Aluminum Sign and Arrow
38082	4" dia.	Self-Sticking Replacement Arrow



Fire Safety Signs

BradyID.com/s36

Fire Safety Signs (continued)



80160 14" x 10" BGSS



90558 5" x 14" BGSS



73481 10" x 14" FB
85273 7" x 10" SS
43303 7" x 10" AL
43304 10" x 14" AL



71046 10" x 14" FB
85271 7" x 10" SS
85272 10" x 14" SS
43302 10" x 14" AL



71732 10" x 14" FB
85279 7" x 10" SS
85280 10" x 14" SS
25730 7" x 10" PL
43307 7" x 10" AL



90370 7" x 10" SS



90106 7" x 10" BGSS
90620 10" x 14" BGSS
90948 7" x 10" BGPL
90632 10" x 14" BGPL



90576 5" x 14" BGSS
90895 5" x 14" BGPL



127244 7" x 10" SS
127247 10" x 14" SS
127243 7" x 10" PL
127246 10" x 14" PL
127242 7" x 10" AL
127245 10" x 14" AL



90988 5" x 14" BGPL



90994 5" x 14" BGPL



127250 7" x 10" SS
127253 10" x 14" SS
127249 7" x 10" PL
127252 10" x 14" PL
127248 7" x 10" AL
127251 10" x 14" AL



127262 7" x 10" SS
127265 10" x 14" SS
127261 7" x 10" PL
127264 10" x 14" PL
127260 7" x 10" AL
127263 10" x 14" AL



127238 7" x 10" SS
127241 10" x 14" SS
127237 7" x 10" PL
127240 10" x 14" PL
127236 7" x 10" AL
127239 10" x 14" AL



127268 7" x 10" SS
127271 10" x 14" SS
127267 7" x 10" PL
127270 10" x 14" PL
127266 7" x 10" AL
127269 10" x 14" AL



127274 10" x 7" SS
127277 14" x 10" SS
127273 10" x 7" PL
127276 14" x 10" PL
127272 10" x 7" AL
127275 14" x 10" AL



90930 5" x 14" BGPL



90107 7" x 10" BGSS
90781 7" x 10" BGPL



90554 10" x 7" BGSS
90187 14" x 10" BGSS
90718 10" x 7" BGPL
90780 14" x 10" BGPL



76870 7" x 7" FB
122707 10" x 14" FB
84684 7" x 7" SS
122567 10" x 14" SS
22498 7" x 10" PL
122467 10" x 14" PL
41062 7" x 10" AL
122341 10" x 14" AL

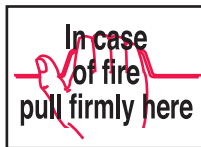

90380 5" x 7" SS



127256 7" x 10" SS
127259 10" x 14" SS
127255 7" x 10" PL
127258 10" x 14" PL
127254 7" x 10" AL
127257 10" x 14" AL



Safety Signs

Fire Safety Signs

BradyID.com/s36

Fire Safety Signs (continued)



127280	7" x 10"	SS
127283	10" x 14"	SS
127279	7" x 10"	PL
127282	10" x 14"	PL
127278	7" x 10"	AL
127281	10" x 14"	AL



127286	7" x 10"	SS
127289	10" x 14"	SS
127285	7" x 10"	PL
127288	10" x 14"	PL
127284	7" x 10"	AL
127287	10" x 14"	AL



127292	7" x 10"	SS
127295	10" x 14"	SS
127291	7" x 10"	PL
127294	10" x 14"	PL
127290	7" x 10"	AL
127293	10" x 14"	AL



71985	14" x 20"	FB
-------	-----------	----

Sign Selection Guide

- FB - Premium fiberglass (B-120)
- SS - Self-sticking polyester (B-302)
- PL - Plastic (B-401)
- AL - Aluminum (B-555)
- BGSS - BradyGlo™ self-stick polyester (B-324)
- BGPL - BradyGlo™ plastic (B-347)

Material Comparison page 408
Sign Legend Index..... page 588



127298	7" x 10"	SS
127301	10" x 14"	SS
127297	7" x 10"	PL
127300	10" x 14"	PL
127296	7" x 10"	AL
127299	10" x 14"	AL



90993	5" x 14"	BGPL
-------	----------	------



51547	10" x 14"	AL
-------	-----------	----



127304	10" x 7"	SS
127307	14" x 10"	SS
127303	10" x 7"	PL
127306	14" x 10"	PL
127302	10" x 7"	AL
127305	14" x 10"	AL



69500	10" x 14"	FB
85297	7" x 10"	SS
85298	10" x 14"	SS
22690	7" x 10"	PL
22691	10" x 14"	PL
41254	7" x 10"	AL
41255	10" x 14"	AL



90573	5" x 14"	BGSS
90992	5" x 14"	BGPL



127310	7" x 10"	SS
127313	10" x 14"	SS
127309	7" x 10"	PL
127312	10" x 14"	PL
127308	7" x 10"	AL
127311	10" x 14"	AL



51549	10" x 14"	AL
-------	-----------	----



90996	5" x 14"	BGPL
-------	----------	------



90368	7" x 10"	SS
-------	----------	----



85299	3.5" x 10"	SS
22692	7" x 10"	PL
41256	7" x 10"	AL



71779	10" x 14"	FB
22693	7" x 10"	PL
41257	7" x 10"	AL



127322	7" x 10"	SS
127325	10" x 14"	SS
127321	7" x 10"	PL
127324	10" x 14"	PL
127320	7" x 10"	AL
127323	10" x 14"	AL



127316	7" x 10"	SS
127319	10" x 14"	SS
127315	7" x 10"	PL
127318	10" x 14"	PL
127314	7" x 10"	AL
127317	10" x 14"	AL



127328	7" x 10"	SS
127331	10" x 14"	SS
127327	7" x 10"	PL
127330	10" x 14"	PL
127326	7" x 10"	AL
127329	10" x 14"	AL



85305	10" x 14"	SS
22695	7" x 10"	PL
41260	10" x 14"	AL



127334	7" x 10"	SS
127337	10" x 14"	SS
127333	7" x 10"	PL
127336	10" x 14"	PL
127332	7" x 10"	AL
127335	10" x 14"	AL



90553	7" x 10"	BGSS
90186	10" x 14"	BGSS



90185	10" x 14"	BGSS
-------	-----------	------



90386	5" x 14"	SS
-------	----------	----



First Aid Signs

Brady first aid signs identify safety equipment and first aid stations. Designed with pictograms, bold text and bright colors, Brady's first aid signs clearly indicate the locations of first aid kits, safety showers, eyewash stations and other safety equipment. First aid signs reinforce safe work practices and ensure that your employees are prepared for accidents and emergencies.



74940	14" x 20"	FB
85308	10" x 14"	SS
22632	7" x 10"	PL
22633	10" x 14"	PL
41197	10" x 14"	AL



70227	10" x 14"	FB
85309	7" x 10"	SS
85310	10" x 14"	SS
22635	10" x 14"	PL
41198	7" x 10"	AL



85311	7" x 10"	SS
85312	10" x 14"	SS
22636	7" x 10"	PL
22637	10" x 14"	PL
41200	7" x 10"	AL
41201	10" x 14"	AL



127394	7" x 10"	SS
127397	10" x 14"	SS
127393	7" x 10"	PL
127396	10" x 14"	PL
127392	7" x 10"	AL
127395	10" x 14"	AL



127412	7" x 10"	SS
127415	10" x 14"	SS
127411	7" x 10"	PL
127414	10" x 14"	PL
127410	7" x 10"	AL
127413	10" x 14"	AL



127400	7" x 10"	SS
127403	10" x 14"	SS
127399	7" x 10"	PL
127402	10" x 14"	PL
127398	7" x 10"	AL
127401	10" x 14"	AL



127418	7" x 10"	SS
127421	10" x 14"	SS
127417	7" x 10"	PL
127420	10" x 14"	PL
127416	7" x 10"	AL
127419	10" x 14"	AL



127406	7" x 10"	SS
127409	10" x 14"	SS
127405	7" x 10"	PL
127408	10" x 14"	PL
127404	7" x 10"	AL
127407	10" x 14"	AL



69463	7" x 17"	FB
-------	----------	----



69088	7" x 17"	FB
-------	----------	----



74097	10" x 14"	FB
74966	14" x 20"	FB
85315	7" x 10"	SS
85316	10" x 14"	SS
22638	7" x 10"	PL
22639	10" x 14"	PL
41202	7" x 10"	AL
41203	10" x 14"	AL



85321	7" x 10"	SS
85322	10" x 14"	SS
22642	7" x 10"	PL
22643	10" x 14"	PL
41206	7" x 10"	AL
41207	10" x 14"	AL



85323	10" x 7"	SS
85324	14" x 10"	SS
22644	10" x 7"	PL
22645	14" x 10"	PL
41208	10" x 7"	AL
41209	14" x 10"	AL



127430	7" x 10"	SS
127433	10" x 14"	SS
127429	7" x 10"	PL
127432	10" x 14"	PL
127428	7" x 10"	AL
127431	10" x 14"	AL



75962	10" x 7"	FB
75963	14" x 10"	FB
85325	10" x 7"	SS
85326	14" x 10"	SS
22646	10" x 7"	PL
22647	14" x 10"	PL
41210	10" x 7"	AL
41211	14" x 10"	AL



85327	7" x 10"	SS
85328	10" x 14"	SS
22648	7" x 10"	PL
22649	10" x 14"	PL
41213	10" x 14"	AL



127424	7" x 10"	SS
127427	10" x 14"	SS
127423	7" x 10"	PL
127426	10" x 14"	PL
127422	7" x 10"	AL
127425	10" x 14"	AL

Regulations

First Aid 1910.252(f)(13), 1910.151(b) (Informational Marking):

First aid supplies...shall be readily available.

Emergency Eyewash and Shower 1910.151(c) (Informational Marking):

Suitable facilities for quick drenching or flushing of the eyes and body must be provided in the work area for emergency use if workers are exposed to injurious corrosive materials.

Appendix A (non-mandatory appendix) to 1910.1450:

The National Research Council Recommendations Concerning Chemical Hygiene in Laboratories, recommends that location signs for safety showers, eyewash stations and other safety and first aid equipment be posted.

Respirators 1910.134(f)(5)(i):

Respirators placed at stations and work areas for emergency use should be quickly accessible at all times and should be stored in compartments built for this purpose. The compartments should be clearly marked.

First Aid Signs

BradyID.com/s36

First Aid Signs (continued)



127436	7" x 10"	SS
127439	10" x 14"	SS
127435	7" x 10"	PL
127438	10" x 14"	PL
127434	7" x 10"	AL
127437	10" x 14"	AL



122722	10" x 14"	FB
85331	7" x 10"	SS
85332	10" x 14"	SS
22650	7" x 10"	PL
22651	10" x 14"	PL
41214	7" x 10"	AL
41215	10" x 14"	AL



85333	7" x 10"	SS
85334	10" x 14"	SS
22652	7" x 10"	PL
22653	10" x 14"	PL
41217	10" x 14"	AL



22654	7" x 10"	PL
22655	10" x 14"	PL
73493	14" x 20"	FB
85337	7" x 10"	SS
85338	10" x 14"	SS
41218	7" x 10"	AL
41219	10" x 14"	AL

Sign Selection Guide

- FB - Premium fiberglass (B-120)
- SS - Self-sticking polyester (B-302)
- PL - Plastic (B-401)
- AL - Aluminum (B-555)
- BGSS - BradyGlo™ self-stick polyester (B-324)
- BGPL - BradyGlo™ plastic (B-347)

Material Comparison page 408
Sign Legend Index..... page 588



127442	7" x 10"	SS
127445	10" x 14"	SS
127441	7" x 10"	PL
127444	10" x 14"	PL
127440	7" x 10"	AL
127443	10" x 14"	AL



127448	7" x 10"	SS
127451	10" x 14"	SS
127447	7" x 10"	PL
127450	10" x 14"	PL
127446	7" x 10"	AL
127449	10" x 14"	AL



99326	10" x 14"	FB
85343	7" x 10"	SS
85344	10" x 14"	SS
22656	7" x 10"	PL
41220	7" x 10"	AL
41221	10" x 14"	AL



73442	5" x 14"	FB
85346	5" x 14"	SS
22659	10" x 14"	PL
41223	10" x 14"	AL



87662	10" x 14"	FB
29067	7" x 10"	SS
29079	10" x 14"	SS
29069	7" x 10"	PL
29081	10" x 14"	PL
29076	7" x 10"	AL
29082	10" x 14"	AL



43511	10" x 14"	AL
-------	-----------	----



43511	10" x 14"	AL
122853	7" x 10"	FB
72700	10" x 14"	FB
87785	3.5" x 5"	SS
85349	7" x 10"	SS
85350	10" x 14"	SS
22661	7" x 10"	PL
22662	10" x 14"	PL
41225	7" x 10"	AL
41226	10" x 14"	AL



122872	7" x 10"	FB
122733	10" x 14"	FB
88502	7" x 7"	SS
122663	7" x 10"	SS
122587	10" x 14"	SS
25167	7" x 10"	PL
122483	10" x 14"	PL
42744	7" x 10"	AL
122362	10" x 14"	AL



122871	7" x 10"	FB
122732	10" x 14"	FB
122662	7" x 10"	SS
122586	10" x 14"	SS
122536	7" x 10"	PL
122482	10" x 14"	PL
122427	7" x 10"	AL
122361	10" x 14"	AL



72708	10" x 14"	FB
85352	7" x 10"	SS
85353	10" x 14"	SS
22663	7" x 10"	PL
22664	10" x 14"	PL
41227	7" x 10"	AL



72722	7" x 10"	FB
122720	10" x 14"	FB
87786	3.5" x 5"	SS
85354	7" x 10"	SS
85355	10" x 14"	SS
22665	7" x 10"	PL
122473	10" x 14"	PL
41229	7" x 10"	AL
122349	10" x 14"	AL



122911	7" x 10"	FB
69232	7" x 17"	FB
122734	10" x 14"	FB
122664	7" x 10"	SS
122588	10" x 14"	SS
122537	7" x 10"	PL
25904	10" x 14"	PL
122428	7" x 10"	AL
43481	10" x 14"	AL



First Aid Signs (continued)



85356	3.5' x 10'	SS
22666	7' x 10'	PL
41230	7' x 10'	AL



69250	7' x 17'	FB
-------	----------	----



85359	3.5' x 10'	SS
22669	7' x 10'	PL
41233	7' x 10'	AL



73538	3.5' x 10'	BGSS
80245	5' x 14'	BGSS
85478	5' x 14'	BGPL



70345	3.5' x 10'	FB
85360	3.5' x 10'	SS
22670	7' x 10'	PL



122902	7' x 10'	FB
122764	10' x 14'	FB
85361	3.5' x 10'	SS
122694	7' x 10'	SS
122618	10' x 14'	SS
22671	7' x 10'	PL
122495	10' x 14'	PL
122451	7' x 10'	AL
122382	10' x 14'	AL



123751	10' x 7'	SS
123754	14' x 10'	SS
123750	10' x 7'	PL
123753	14' x 10'	PL
123749	10' x 7'	AL
123752	14' x 10'	AL



70347	10' x 14'	FB
85362	7' x 10'	SS
85363	10' x 14'	SS
22672	7' x 10'	PL
22673	10' x 14'	PL
41236	7' x 10'	AL
41237	10' x 14'	AL



85358	3.5' x 14'	SS
22668	7' x 10'	PL
41232	7' x 10'	AL



85357	5' x 14'	SS
22667	7' x 10'	PL
41231	7' x 10'	AL

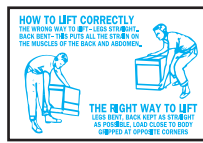

85370	7' x 10'	SS
85371	10' x 14'	SS
22680	7' x 10'	PL
22681	10' x 14'	PL
41244	7' x 10'	AL
41245	10' x 14'	AL

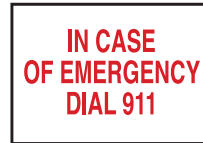

76095	7' x 10'	FB
76096	10' x 14'	FB
85368	7' x 10'	SS
85369	10' x 14'	SS
22678	7' x 10'	PL
22679	10' x 14'	PL
41243	10' x 14'	AL



127376	10' x 7'	SS
127379	14' x 10'	SS
127375	10' x 7'	PL
127378	14' x 10'	PL
127374	10' x 7'	AL
127377	14' x 10'	AL



85375	10' x 14'	SS
22684	7' x 10'	PL
22685	10' x 14'	PL
41248	7' x 10'	AL
41249	10' x 14'	AL



122858	7' x 10'	FB
72897	7' x 20'	FB
72883	10' x 14'	FB
85377	7' x 10'	SS
85378	10' x 14'	SS
22686	7' x 10'	PL
122475	10' x 14'	PL
41250	7' x 10'	AL
122351	10' x 14'	AL



88528	7' x 7'	SS
42766	7' x 10'	AL



127388	7' x 10'	SS
127391	10' x 14'	SS
127387	7' x 10'	PL
127390	10' x 14'	PL
127386	7' x 10'	AL
127389	10' x 14'	AL



127382	10' x 7'	SS
127385	14' x 10'	SS
127381	10' x 7'	PL
127384	14' x 10'	PL
127380	10' x 7'	AL
127383	14' x 10'	AL



90607	5' x 14'	BGSS
90935	5' x 14'	BGPL

Floor Signs

BradyID.com/s36

Floor Signs

Brady floor safety signs are a durable, highly visible way to communicate important safety and warning messages in your facility. Safety floor decals can be used to provide direction, point to exits, and provide warnings for enhanced workplace safety. Brady floor signs feature a strong adhesive backing that sticks to almost any dry, clean surface, as well as a clear anti-slip surface that helps prevent accidental falls.

Sign Selection Guide

SS - Self-sticking polyester (B-302)
BGSS - BradyGlo™ self-stick polyester (B-324)

Regulations

Phosphorescent Floor Signs address section 4.2.1 Floor Mounted Markings

The ASTM guide for recommended uses of photoluminescent safety markings describes recommended uses and information on installation of photoluminescent safety markings to supplement emergency lighting.



97616 17" dia. SS



13284 17" dia. SS



92400 17" dia. SS

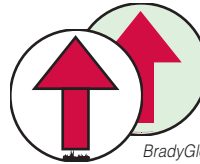

BradyGlo

49057 17" dia. BGSS
49058 17" dia. SS



47437 17" dia. SS



BradyGlo

49806 17" dia. BGSS
49805 17" dia. SS



49801 17" dia. SS



92405 17" dia. SS



49067 17" dia. SS



49068 17" dia. SS



BradyGlo

49061 17" dia. BGSS
49060 17" dia. SS



92406 17" dia. SS



97609 17" dia. SS



49065 17" dia. SS



BradyGlo

49062 17" dia. BGSS
49064 17" dia. SS



49066 17" dia. SS



29294 17" dia. SS



49063 17" dia. SS



92407 17" dia. SS



97610 17" dia. SS



97611 17" dia. SS



97613 17" dia. SS



92408 17" dia. SS



29296 17" dia. SS



97614 17" dia. SS



97615 17" dia. SS



92404 17" dia. SS



49807 17" dia. SS

ToughStripe® Floor Marking Signs

ToughStripe (TS) polyester floor signs resist harsh chemicals and are specifically designed to alert workers of potential dangers and enforce protective equipment requirements.

- Exceeds safety standards for clean, dry non-slip surfaces per ANSI A1264.2-2006 and OSHA 1910.22
- 3 mil thickness; service temperature range of 0° F to 129° F
- Black areas of signs are coated with anti-skid tread
- US Patent No: 8,302,337



104489 17" dia. TS 104495 17" dia. TS 104496 17" dia. TS 104490 17" dia. TS 104492 17" dia. TS 104493 17" dia. TS 104494 17" dia. TS



104509 17" dia. TS 104501 17" dia. TS 104512 17" dia. TS 104513 17" dia. TS 104486 17" dia. TS 104487 17" dia. TS 104507 17" dia. TS



104511 17" dia. TS 104508 17" dia. TS 104488 14" x 18" TS 104491 14" x 18" TS 104497 14" x 18" TS 104498 14" x 18" TS 104499 14" x 18" TS



104500 14" x 18" TS 104502 14" x 18" TS 104503 14" x 18" TS 104504 14" x 18" TS 104505 14" x 18" TS 104506 14" x 18" TS 104510 14" x 18" TS

Don't miss: ToughStripe Floor Marking Tape

ToughStripe Floor Marking Tape offers superior durability and high visibility making it ideal for marking aisles, passageways, storage locations and pointing out important safety equipment and egress paths.

View **page 295** for ToughStripe tapes and die-cut shapes.



Funny Signs

BradyID.com/s36

Funny Signs

Brady funny signs are a great way to bring a bit of humor into your office or facility. These funny signs look exactly like our traditional sign products, but feature humorous messages, pictures and sayings that are bound to make you laugh. Funny signs are a perfect gift for fellow employees and can lighten the mood in the office.

Sign Selection Guide

- FB** - Premium fiberglass (B-120)
- SS** - Self-sticking polyester (B-302)
- PL** - Plastic (B-401)
- AL** - Aluminum (B-555)
- BGSS** - BradyGlo™ self-stick polyester (B-324)
- BGPL** - BradyGlo™ plastic (B-347)

Material Comparison page 408
 Sign Legend Index..... page 588

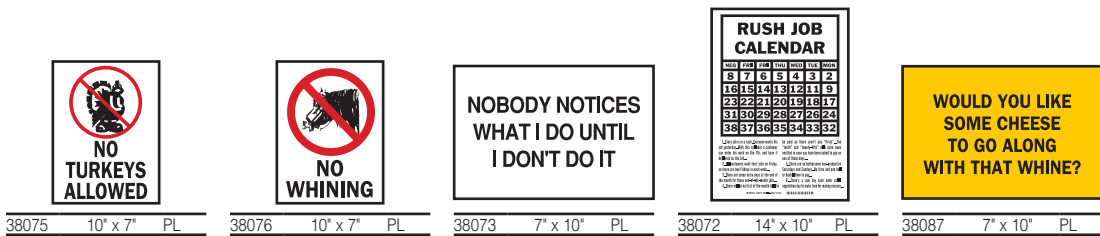

Safety Signs



Create your own funny signs online

BradyID.com/customsigns

High-Visibility Signs

Brady high-visibility signs feature bright colors, graphics and pictograms to effectively communicate a safety message, identify a location or to clearly mark safety equipment for quick and easy access in an emergency situation.



L-Style 90° Angle
(Legend appears on both sides)

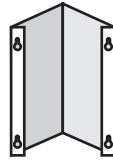

V-Style 45° Angle
(Legend repeated on outward facing sides)

Sign Selection Guide

- PL** - Plastic (B-401)
- AL** - Aluminum (B-555)
- BGSS** - BradyGlo™ self-stick polyester (B-324)
- BGPL** - BradyGlo™ plastic (B-347 or similar)
- PolyE** - Polyethylene (B-450)

Material Comparison page 408
Sign Legend Index..... page 588

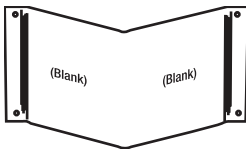

60499 12" x 18" PolyE



L0AE01A 8" x 8" Acrylic



V1AE01A 6" x 9" x 4" Acrylic



132239 6" x 9" x 4" Acrylic



V1DS24A 6" x 9" x 4" Acrylic



V1EP24A 6" x 9" x 4" Acrylic



45369 5.5" x 10" x 4" PL



V1ESG1G 6" x 9" x 4" Acrylic



45379 12" x 18" x 8" PL



50684 4" x 12" PL



V2EX01A 8" x 15" x 6" Acrylic



45422 12" x 9" PolyE



94022 12" x 9" BGPL



45363 5.5" x 10" x 4" PL



L0EW03A 8" x 8" Acrylic



V1EW03A 6" x 9" x 4" Acrylic
49044 12" x 18" PolyE



V1EWG1G 6" x 9" x 4" Acrylic



V3EW03A 11" x 12" x 5" Acrylic



94027 12" x 9" BGPL
PolyE 12" x 9" PL



96907 12" x 18" PolyE



50783 18" x 7.5" PL



45365 5.5" x 10" x 4" PL



L0FL15A 8" x 8" Acrylic



V1FL15A 6" x 9" x 4" Acrylic



50688 12" x 4" BGPL

50687 12" x 4" PL



50777 18" x 7.5" PL



50786 18" x 7.5" BGPL

50785 18" x 7.5" PL



SP184L 18" x 4.5" Acrylic



SP818V 18" x 8.5" x 3.25" Acrylic

High-Visibility Signs

BradyID.com/s36

High-Visibility Signs (continued)



94008 12" x 9" BGPL
70998 12" x 9" PolyE



96908 12" x 18" PolyE



94044 12" x 9" BGPL

Sign Selection Guide

- PL - Plastic (B-401)
- AL - Aluminum (B-555)
- BGSS - BradyGlo™ self-stick polyester (B-324)
- BGPL - BradyGlo™ plastic (B-347 or similar)
- PolyE - Polyethylene (B-450)

Material Comparison page 408
Sign Legend Index..... page 588



45366 5.5" x 10" x 4" PL
80702 8" x 14.5" x 6" PL



45368 5.5" x 10" x 4" PL
80703 8" x 14.5" x 6" PL



LOFEG1G 8" x 8" Acrylic



V1FEG1G 6" x 9" x 4" Acrylic



LOFE15A 8" x 8" Acrylic



V1FE15A 6" x 8" x 4" Acrylic



50692 12" x 4" BGPL
50691 12" x 4" PL
50693 18" x 4" PL



L3FE15A 11" x 17" Acrylic



V3FE15A 11" x 12" x 5" Acrylic



94029 12" x 9" BGPL



70999 12" x 9" PolyE

Safety Signs



50784 18" x 7.5" BGPL



V1FHG1G 6" x 9" x 4" Acrylic



50696 12" x 4" BGPL
50698 18" x 4" BGPL
50695 12" x 4" PL
50697 18" x 4" PL



94054 12" x 9" BGPL



94014 12" x 9" BGPL
45370 5.5" x 10" x 4" PL



50685 4" x 12" PL



45367 5.5" x 10" x 4" PL



45375 8" x 14.5" x 6" PL



V1LS01A 6" x 9" x 4" Acrylic

High-Visibility Signs

BradyID.com/s36

High-Visibility Signs (continued)



LOME02A 8' x 8' Acrylic



V1ME02A 6' x 9' x 4' Acrylic



V2MS24A 8' x 15' x 6' Acrylic



V2MS21A 8' x 14.5' x 6' B-494



45378 8' x 14.5' x 6' PL



V1MS03A 6' x 9' x 4' Acrylic
49045 12' x 18' PolyE



LOMS03A 8' x 8' Acrylic
49042 12' x 9' PolyE



V1CP45A 6' x 9' x 4' Acrylic



45376 8' x 14.5' x 6' PL



LOPH02A 8' x 8' Acrylic



V1PH02A 6' x 9' x 4' Acrylic



V1RR02A 6' x 9' x 4' Acrylic



V1RR45A 6' x 9' x 4' Acrylic



45377 8' x 14.5' x 6' PL



80705 12' x 18' x 8' PL



LOSS03A 8' x 8' Acrylic



V1SS03A 6' x 9' x 4' Acrylic
49043 12' x 18' PolyE



V1SSG4G 6' x 9' x 4' Acrylic



139907 12' x 18' x 8' PolyE



139787 8' x 8' Plastic



139786 8' x 14.5' x 6' Plastic



LOSWG4G 8' x 8' Acrylic



V1SWG4G 6' x 9' x 4' Acrylic



LOSR03A 8' x 8' Acrylic



V1SR03A 6' x 9' x 4' Acrylic



V2SS24A 8' x 15' x 6' Acrylic



V1TOG1G 6' x 9' x 4' Acrylic



LOTS024A 8' x 8' Acrylic



V1TS024A 6' x 9' x 4' Acrylic



V1WH45A 6' x 9' x 4' PL



LOWO02A 8' x 8' Acrylic



V1WO02A 6' x 9' x 4' Acrylic



45373 5.5' x 10' x 4' PL



V1WO45A 6' x 9' x 4' Acrylic

Safety Signs

Hospital Signs

BradyID.com/s36

Hospital Signs

Brady hospital signs feature universal wayfinding symbols to clearly direct visitors of all languages to their destination. Hospital wayfinding signs are a great alternative to multi-lingual signs which are often difficult to read. Brady wayfinding signs can be customized by size, color and text and are available in aluminum, plastic and self-sticking materials.

Sign Selection Guide

- FB** - Premium fiberglass (B-120)
- SS** - Self-sticking polyester (B-302)
- PL** - Plastic (B-401)
- AL** - Aluminum (B-555)
- BGSS** - BradyGlo™ self-stick polyester (B-324)
- BGPL** - BradyGlo™ plastic (B-347)

Material Comparison page 408
 Sign Legend Index..... page 588

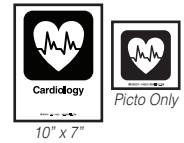
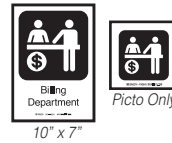
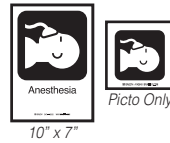
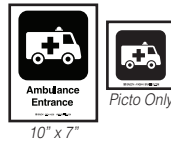
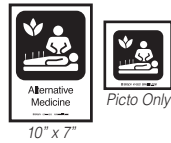
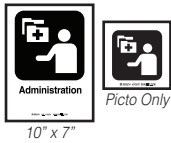

142647	4" x 4"	SS
142593	8" x 8"	SS
142539	10" x 7"	SS
142485	10" x 7"	PL
142431	10" x 7"	AL

142621	4" x 4"	SS
142567	8" x 8"	SS
142513	10" x 7"	SS
142459	10" x 7"	PL
142405	10" x 7"	AL

142644	4" x 4"	SS
142590	8" x 8"	SS
142536	10" x 7"	SS
142482	10" x 7"	PL
142428	10" x 7"	AL

142640	4" x 4"	SS
142586	8" x 8"	SS
142532	10" x 7"	SS
142478	10" x 7"	PL
142424	10" x 7"	AL

142649	4" x 4"	SS
142595	8" x 8"	SS
142541	10" x 7"	SS
142487	10" x 7"	PL
142433	10" x 7"	AL

142633	4" x 4"	SS
142579	8" x 8"	SS
142525	10" x 7"	SS
142471	10" x 7"	PL
142417	10" x 7"	AL

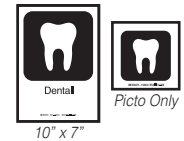
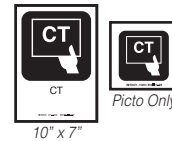
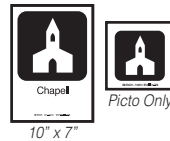
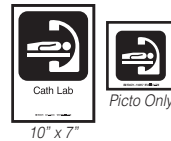
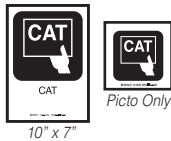

142612	4" x 4"	SS
142558	8" x 8"	SS
142504	10" x 7"	SS
142450	10" x 7"	PL
142396	10" x 7"	AL

142664	4" x 4"	SS
142610	8" x 8"	SS
142556	10" x 7"	SS
142502	10" x 7"	PL
142448	10" x 7"	AL

142657	4" x 4"	SS
142603	8" x 8"	SS
142549	10" x 7"	SS
142495	10" x 7"	PL
142441	10" x 7"	AL

142654	4" x 4"	SS
142600	8" x 8"	SS
142546	10" x 7"	SS
142492	10" x 7"	PL
142438	10" x 7"	AL

142663	4" x 4"	SS
142609	8" x 8"	SS
142555	10" x 7"	SS
142501	10" x 7"	PL
142447	10" x 7"	AL

142639	4" x 4"	SS
142585	8" x 8"	SS
142531	10" x 7"	SS
142477	10" x 7"	PL
142423	10" x 7"	AL

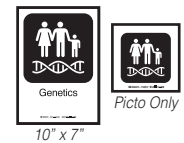
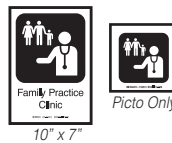
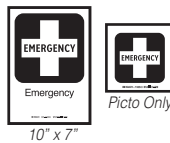
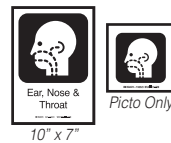
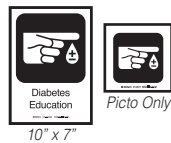
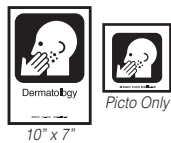

142628	4" x 4"	SS
142574	8" x 8"	SS
142520	10" x 7"	SS
142466	10" x 7"	PL
142412	10" x 7"	AL

142617	4" x 4"	SS
142563	8" x 8"	SS
142509	10" x 7"	SS
142455	10" x 7"	PL
142401	10" x 7"	AL

142629	4" x 4"	SS
142575	8" x 8"	SS
142521	10" x 7"	SS
142467	10" x 7"	PL
142413	10" x 7"	AL

142643	4" x 4"	SS
142589	8" x 8"	SS
142535	10" x 7"	SS
142481	10" x 7"	PL
142427	10" x 7"	AL

142618	4" x 4"	SS
142564	8" x 8"	SS
142510	10" x 7"	SS
142456	10" x 7"	PL
142402	10" x 7"	AL

142637	4" x 4"	SS
142583	8" x 8"	SS
142529	10" x 7"	SS
142475	10" x 7"	PL
142421	10" x 7"	AL

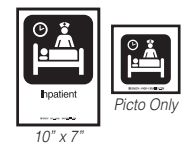
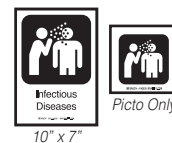
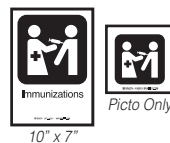
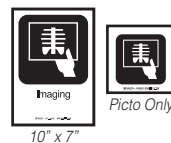
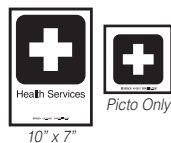
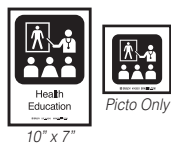

142651	4" x 4"	SS
142597	8" x 8"	SS
142543	10" x 7"	SS
142489	10" x 7"	PL
142435	10" x 7"	AL

142611	4" x 4"	SS
142557	8" x 8"	SS
142503	10" x 7"	SS
142449	10" x 7"	PL
142395	10" x 7"	AL

142660	4" x 4"	SS
142606	8" x 8"	SS
142552	10" x 7"	SS
142498	10" x 7"	PL
142444	10" x 7"	AL





























































142619	4" x 4"	SS
142565	8" x 8"	SS
142511	10" x 7"	SS
142457	10" x 7"	PL
142403	10" x 7"	AL

142638	4" x 4"	SS
142584	8" x 8"	SS
142530	10" x 7"	SS
142476	10" x 7"	PL
142422	10" x 7"	AL

142614	4" x 4"	SS
142560	8" x 8"	SS
142506	10" x 7"	SS
142452	10" x 7"	PL
142398	10" x 7"	AL

Safety Signs

Hospital Signs (continued)

 Intensive Care 10" x 7"	 Picto Only	 Internal Medicine 10" x 7"	 Picto Only	 Interpretive Services 10" x 7"	 Picto Only	 Kidney 10" x 7"	 Picto Only	 Laboratory 10" x 7"	 Picto Only	 Mammography 10" x 7"	 Picto Only
142613 4" x 4" SS	142559 8" x 8" SS	142631 4" x 4" SS	142577 8" x 8" SS	142652 4" x 4" SS	142598 8" x 8" SS	142632 4" x 4" SS	142578 8" x 8" SS	142622 4" x 4" SS	142568 8" x 8" SS	142656 4" x 4" SS	142602 8" x 8" SS
142505 10" x 7" SS	142451 10" x 7" PL	142523 10" x 7" SS	142469 10" x 7" PL	142544 10" x 7" SS	142490 10" x 7" PL	142524 10" x 7" SS	142470 10" x 7" PL	142514 10" x 7" SS	142460 10" x 7" PL	142514 10" x 7" SS	142494 10" x 7" PL
142397 10" x 7" AL		142415 10" x 7" AL		142436 10" x 7" AL		142416 10" x 7" AL		142406 10" x 7" AL		142440 10" x 7" AL	
 Medical Library 10" x 7"	 Picto Only	 Medical Records 10" x 7"	 Picto Only	 Mental Health 10" x 7"	 Picto Only	 MRI 10" x 7"	 Picto Only	 MRI/PET 10" x 7"	 Picto Only	 Neurology 10" x 7"	 Picto Only
142650 4" x 4" SS	142596 8" x 8" SS	142648 4" x 4" SS	142594 8" x 8" SS	142626 4" x 4" SS	142572 8" x 8" SS	142661 4" x 4" SS	142607 8" x 8" SS	142658 4" x 4" SS	142604 8" x 8" SS	142627 4" x 4" SS	142573 8" x 8" SS
142542 10" x 7" SS	142488 10" x 7" PL	142540 10" x 7" SS	142486 10" x 7" PL	142518 10" x 7" SS	142464 10" x 7" PL	142553 10" x 7" SS	142499 10" x 7" PL	142550 10" x 7" SS	142496 10" x 7" PL	142519 10" x 7" SS	142465 10" x 7" PL
142434 10" x 7" AL		142432 10" x 7" AL		142410 10" x 7" AL		142445 10" x 7" AL		142442 10" x 7" AL		142411 10" x 7" AL	
 Nutrition 10" x 7"	 Picto Only	 OB Clinic 10" x 7"	 Picto Only	 Oncology 10" x 7"	 Picto Only	 Ophthalmology 10" x 7"	 Picto Only	 Outpatient 10" x 7"	 Picto Only	 Pathology 10" x 7"	 Picto Only
142620 4" x 4" SS	142566 8" x 8" SS	142635 4" x 4" SS	142581 8" x 8" SS	142624 4" x 4" SS	142570 8" x 8" SS	142625 4" x 4" SS	142571 8" x 8" SS	142615 4" x 4" SS	142561 8" x 8" SS	142623 4" x 4" SS	142569 8" x 8" SS
142512 10" x 7" SS	142458 10" x 7" PL	142527 10" x 7" SS	142473 10" x 7" PL	142516 10" x 7" SS	142462 10" x 7" PL	142517 10" x 7" SS	142463 10" x 7" PL	142507 10" x 7" SS	142453 10" x 7" PL	142515 10" x 7" SS	142461 10" x 7" PL
142404 10" x 7" AL		142419 10" x 7" AL		142408 10" x 7" AL		142409 10" x 7" AL		142399 10" x 7" AL		142407 10" x 7" AL	
 Pediatrics 10" x 7"	 Picto Only	 PET 10" x 7"	 Picto Only	 Pharmacy 10" x 7"	 Picto Only	 Physical Therapy 10" x 7"	 Picto Only	 Radiology 10" x 7"	 Picto Only	 Registration 10" x 7"	 Picto Only
142636 4" x 4" SS	142582 8" x 8" SS	142662 4" x 4" SS	142608 8" x 8" SS	142616 4" x 4" SS	142562 8" x 8" SS	142642 4" x 4" SS	142588 8" x 8" SS	142655 4" x 4" SS	142601 8" x 8" SS	142645 4" x 4" SS	142591 8" x 8" SS
142528 10" x 7" SS	142474 10" x 7" PL	142554 10" x 7" SS	142500 10" x 7" PL	142508 10" x 7" SS	142454 10" x 7" PL	142534 10" x 7" SS	142480 10" x 7" PL	142547 10" x 7" SS	142493 10" x 7" PL	142537 10" x 7" SS	142483 10" x 7" PL
142420 10" x 7" AL		142446 10" x 7" AL		142400 10" x 7" AL		142426 10" x 7" AL		142439 10" x 7" AL		142429 10" x 7" AL	
 Respiratory 10" x 7"	 Picto Only	 Social Services 10" x 7"	 Picto Only	 Surgery 10" x 7"	 Picto Only	 Ultrasound 10" x 7"	 Picto Only	 Waiting Area 10" x 7"	 Picto Only	 Women's Health 10" x 7"	 Picto Only
142630 4" x 4" SS	142576 8" x 8" SS	142653 4" x 4" SS	142599 8" x 8" SS	142641 4" x 4" SS	142587 8" x 8" SS	142659 4" x 4" SS	142605 8" x 8" SS	142646 4" x 4" SS	142592 8" x 8" SS	142634 4" x 4" SS	142580 8" x 8" SS
142522 10" x 7" SS	142468 10" x 7" PL	142545 10" x 7" SS	142491 10" x 7" PL	142533 10" x 7" SS	142479 10" x 7" PL	142551 10" x 7" SS	142497 10" x 7" PL	142538 10" x 7" SS	142484 10" x 7" PL	142526 10" x 7" SS	142472 10" x 7" PL
142414 10" x 7" AL		142437 10" x 7" AL		142425 10" x 7" AL		142443 10" x 7" AL		142430 10" x 7" AL		142418 10" x 7" AL	

Lockout Tagout Signs

BradyID.com/s36

Lockout Tagout Signs

Brady lockout tagout signs are high quality, industrial-strength safety signs for identifying machinery and equipment that require lockout. These lockout tagout signs can identify energy sources, provide lockout instructions and serve as a reminder for safe lockout tagout procedures. In addition, lockout tagout signs create a safer and a more efficient workplace for employees.

Sign Selection Guide

- FB** - Premium fiberglass (B-120)
- SS** - Self-sticking polyester (B-302)
- PL** - Plastic (B-401)
- AL** - Aluminum (B-555)
- BGSS** - BradyGlo™ self-stick polyester (B-324)
- BGPL** - BradyGlo™ plastic (B-347)
- SSV** - Self-sticking vinyl (B-946)
- MAG** - Magnetic vinyl (B-811)

Material Comparison page 408
Sign Legend Index..... page 588



69763 10" x 14" FB
85754 7" x 10" SS
85755 10" x 14" SS



127484 7" x 10" SS
127487 10" x 14" SS
127483 7" x 10" PL
127486 10" x 14" PL
127482 7" x 10" AL
127485 10" x 14" AL



127490 7" x 10" SS
127493 10" x 14" SS
127489 7" x 10" PL
127492 10" x 14" PL
127488 7" x 10" AL
127491 10" x 14" AL



60175 2.25" x 4.5" SSV



127496 7" x 10" SS
127499 10" x 14" SS
127495 7" x 10" PL
127498 10" x 14" PL
127494 7" x 10" AL
127497 10" x 14" AL



60162 2" x 2" SSV



127502 7" x 10" SS
127505 10" x 14" SS
127501 7" x 10" PL
127504 10" x 14" PL
127500 7" x 10" AL
127503 10" x 14" AL



127508 7" x 10" SS
127511 10" x 14" SS
127507 7" x 10" PL
127510 10" x 14" PL
127506 7" x 10" AL
127509 10" x 14" AL



127514 7" x 10" SS
127517 10" x 14" SS
127513 7" x 10" PL
127516 10" x 14" PL
127512 7" x 10" AL
127515 10" x 14" AL



65571 10" x 7" FB
65570 14" x 10" FB
85846 5" x 3.5" SS
85847 7" x 5" SS
85848 10" x 7" SS
85849 14" x 10" SS
22909 10" x 7" PL
22910 14" x 10" PL
42432 10" x 7" AL
42433 14" x 10" AL



60176 2.25" x 4.5" SSV



127526 7" x 10" SS
127529 10" x 14" SS
127525 7" x 10" PL
127528 10" x 14" PL
127524 7" x 10" AL
127527 10" x 14" AL



127520 7" x 10" SS
127523 10" x 14" SS
127519 7" x 10" PL
127522 10" x 14" PL
127518 7" x 10" AL
127521 10" x 14" AL



60178 2.25" x 4.5" SSV



60173 2.25" x 4.5" SSV



60172 2.25" x 4.5" SSV



127532 7" x 10" SS
127535 10" x 14" SS
127531 7" x 10" PL
127534 10" x 14" PL
127530 7" x 10" AL
127533 10" x 14" AL



122776 10" x 7" FB
65516 14" x 10" FB
85890 5" x 3.5" SS
85891 7" x 5" SS
122628 10" x 7" SS
85893 14" x 10" SS
22931 10" x 7" PL
22932 14" x 10" PL
42454 10" x 7" AL
42455 14" x 10" AL



60170 2.25" x 4.5" SSV



65575 10" x 7" FB
65576 14" x 10" FB
85911 5" x 3.5" SS
85912 7" x 5" SS
85913 10" x 7" SS
22943 10" x 7" PL



66004 5" x 3.5" MAG
66005 7" x 5" MAG



127544 7" x 10" SS
127547 10" x 14" SS
127543 7" x 10" PL
127546 10" x 14" PL
127542 7" x 10" AL
127545 10" x 14" AL



66006 5" x 3.5" MAG
66007 7" x 5" MAG



66008 5" x 3.5" MAG
66009 7" x 5" MAG
50269 7" x 10" PL

Safety Signs

Lockout Tagout Signs

BradyID.com/s36

Lockout Tagout Signs (continued)



50269 7' x 10' PL



127550 7' x 10' SS
127553 10' x 14' SS
127549 7' x 10' PL
127552 10' x 14' PL
127548 7' x 10' AL
127551 10' x 14' AL

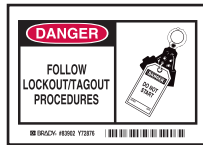

62436 7' x 10' FB
83902 3.5' x 5' SS
83681 7' x 10' SS
21729 7' x 10' PL
26549 10' x 14' PL
46647 7' x 10' AL
46691 10' x 14' AL



127556 7' x 10' SS
127559 10' x 14' SS
127555 7' x 10' PL
127558 10' x 14' PL
127554 7' x 10' AL
127557 10' x 14' AL



127562 7' x 10' SS
127565 10' x 14' SS
127561 7' x 10' PL
127564 10' x 14' PL
127560 7' x 10' AL
127563 10' x 14' AL



127574 7' x 10' SS
127577 10' x 14' SS
127573 7' x 10' PL
127576 10' x 14' PL
127572 7' x 10' AL
127575 10' x 14' AL



123637 7' x 10' SS
123640 10' x 14' SS
123636 7' x 10' PL
123639 10' x 14' PL
123635 7' x 10' AL
123638 10' x 14' AL



127538 7' x 10' SS
127541 10' x 14' SS
127537 7' x 10' PL
127540 10' x 14' PL
127536 7' x 10' AL
127539 10' x 14' AL



127568 7' x 10' SS
127571 10' x 14' SS
127567 7' x 10' PL
127570 10' x 14' PL
127566 7' x 10' AL
127569 10' x 14' AL

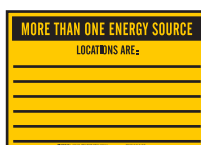

60180 7' x 10' SSV

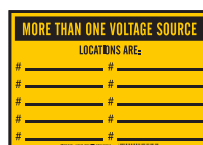

60179 7' x 10' SSV



122799 7' x 10' FB
122778 14' x 10' FB
65511 20' x 14' FB
122638 7' x 10' SS
122629 14' x 10' SS
122506 7' x 10' PL
25922 14' x 10' PL
122395 7' x 10' AL
43519 14' x 10' AL



127580 7' x 10' SS
127583 10' x 14' SS
127579 7' x 10' PL
127582 10' x 14' PL
127578 7' x 10' AL
127581 10' x 14' AL



127592 7' x 10' SS
127595 10' x 14' SS
127591 7' x 10' PL
127594 10' x 14' PL
127590 7' x 10' AL
127593 10' x 14' AL



60177 2.25' x 4.5' SSV



127586 7' x 10' SS
127589 10' x 14' SS
127585 7' x 10' PL
127588 10' x 14' PL
127584 7' x 10' AL
127587 10' x 14' AL



60174 2.25' x 4.5' SSV



65682 10' x 7' FB
89093 7' x 5' SS
25876 10' x 7' PL
25877 14' x 10' PL
43454 14' x 10' AL



88302 2.25' x 4.5' SS



88303 2.25' x 4.5' SS



88304 2.25' x 4.5' SS
122667 7' x 10' SS
122590 10' x 14' SS



88316 2.25' x 4.5' SS



60167 2.25' x 4.5' SSV



88320 2.25' x 4.5' SS



60161 2' x 2' SSV



Machine and Operational Signs

BradyID.com/s36

Machine and Operational Signs

Brady machine safety signs communicate warning messages about the potential dangers of operating machinery and equipment in your facility. These signs remind employees about safety, risks, proper operating instructions and other restrictions.

Sign Selection Guide

- FB** - Premium fiberglass (B-120)
- SS** - Self-sticking polyester (B-302)
- PL** - Plastic (B-401)
- AL** - Aluminum (B-555)
- BGSS** - BradyGlo™ self-stick polyester (B-324)
- BGPL** - BradyGlo™ plastic (B-347)

Material Comparison page 408
 Sign Legend Index..... page 588

85757 10' x 14' SS 22861 7' x 10' PL 22862 10' x 14' PL 42385 10' x 14' AL	127598 7' x 10' SS 127601 10' x 14' SS 127597 7' x 10' PL 127600 10' x 14' PL 127596 7' x 10' AL 127599 10' x 14' AL	124276 7' x 10' SS 124279 10' x 14' SS 124275 7' x 10' PL 124278 10' x 14' PL 124274 7' x 10' AL 124277 10' x 14' AL	124219 7' x 10' SS 124222 10' x 14' SS 124218 7' x 10' PL 124221 10' x 14' PL 124217 7' x 10' AL 124220 10' x 14' AL	127604 7' x 10' SS 127607 10' x 14' SS 127603 7' x 10' PL 127606 10' x 14' PL 127602 7' x 10' AL 127605 10' x 14' AL	127610 7' x 10' SS 127613 10' x 14' SS 127609 7' x 10' PL 127612 10' x 14' PL 127608 7' x 10' AL 127611 10' x 14' AL

85777 7' x 10' SS 85778 10' x 14' SS 22863 7' x 10' PL 22864 10' x 14' PL 42386 7' x 10' AL 42387 10' x 14' AL	69068 10' x 14' FB 85779 7' x 10' SS 85780 10' x 14' SS 22865 7' x 10' PL 42388 7' x 10' AL 42389 10' x 14' AL	85781 7' x 10' SS 22867 7' x 10' PL 42391 10' x 14' AL	69090 10' x 14' FB 85783 7' x 10' SS 22870 10' x 14' PL	127634 7' x 10' SS 127637 10' x 14' SS 127633 7' x 10' PL 127636 10' x 14' PL 127632 7' x 10' AL 127635 10' x 14' AL	22873 7' x 10' PL 22874 10' x 14' PL 42396 7' x 10' AL 42397 10' x 14' AL

70278 10' x 14' FB 85791 7' x 10' SS 85792 10' x 14' SS 22875 7' x 10' PL 22876 10' x 14' PL 42398 7' x 10' AL	47058 7' x 10' FB 85793 7' x 10' SS 22877 7' x 10' PL 22878 10' x 14' PL 42400 7' x 10' AL 42401 10' x 14' AL	47060 7' x 10' FB 122716 10' x 14' FB 87791 3.5' x 5' SS 85797 7' x 10' SS 122576 10' x 14' SS 22879 7' x 10' PL 22880 10' x 14' PL 42402 7' x 10' AL	70280 10' x 14' FB 85799 7' x 10' SS 42404 7' x 10' AL	127628 7' x 10' SS 127631 10' x 14' SS 127627 7' x 10' PL 127630 10' x 14' PL 127626 7' x 10' AL 127629 10' x 14' AL	127616 7' x 10' SS 127619 10' x 14' SS 127615 7' x 10' PL 127618 10' x 14' PL 127614 7' x 10' AL 127617 10' x 14' AL

127622 7' x 10' SS 127625 10' x 14' SS 127621 7' x 10' PL 127624 10' x 14' PL 127620 7' x 10' AL 127623 10' x 14' AL	22891 7' x 10' PL 22892 10' x 14' PL 42414 7' x 10' AL 42415 10' x 14' AL	70322 10' x 14' FB 85813 7' x 10' SS 42416 7' x 10' AL	132082 7' x 10' FB 132083 10' x 14' FB 132080 7' x 10' SS 132081 10' x 14' SS 132078 7' x 10' PL 132079 10' x 14' PL 132076 7' x 10' AL 132077 10' x 14' AL	85819 7' x 10' SS 85820 10' x 14' SS 22895 7' x 10' PL 22896 10' x 14' PL 42418 7' x 10' AL 42419 10' x 14' AL	127640 7' x 10' SS 127643 10' x 14' SS 127639 7' x 10' PL 127642 10' x 14' PL 127638 7' x 10' AL 127641 10' x 14' AL

Safety Signs

Machine and Operational Signs

BradyID.com/s36

Machine and Operational Signs (continued)



122874	7" x 10"	FB
122735	10" x 14"	FB
122666	7" x 10"	SS
122589	10" x 14"	SS
122539	7" x 10"	PL
122484	10" x 14"	PL
122430	7" x 10"	AL
43500	10" x 14"	AL



69031	10" x 14"	FB
85828	10" x 14"	SS
22897	7" x 10"	PL
22898	10" x 14"	PL
42420	7" x 10"	AL
42421	10" x 14"	AL



124243	7" x 10"	SS
124246	10" x 14"	SS
124242	7" x 10"	PL
124245	10" x 14"	PL
124241	7" x 10"	AL
124244	10" x 14"	AL



129086	10" x 7"	SS
129089	14" x 10"	SS
129085	10" x 7"	PL
129088	14" x 10"	PL
129084	10" x 7"	AL
129087	14" x 10"	AL



127646	7" x 10"	SS
127649	10" x 14"	SS
127645	7" x 10"	PL
127648	10" x 14"	PL
127644	7" x 10"	AL
127647	10" x 14"	AL



85831	7" x 10"	SS
22901	7" x 10"	PL
22902	10" x 14"	PL
42424	7" x 10"	AL
42425	10" x 14"	AL



127652	7" x 10"	SS
127655	10" x 14"	SS
127651	7" x 10"	PL
127654	10" x 14"	PL
127650	7" x 10"	AL
127653	10" x 14"	AL



70406	10" x 14"	FB
85838	7" x 10"	SS
22903	7" x 10"	PL
42427	10" x 14"	AL



70409	10" x 14"	FB
85844	7" x 10"	SS
22907	7" x 10"	PL
42430	7" x 10"	AL
42431	10" x 14"	AL



85854	7" x 10"	SS
85855	10" x 14"	SS
22913	7" x 10"	PL
22914	10" x 14"	PL
42436	7" x 10"	AL
42437	10" x 14"	AL



134179	7" x 10"	AL
134180	10" x 14"	AL
134181	18" x 24"	AL
134182	24" x 36"	AL



75126	10" x 14"	FB
85856	7" x 10"	SS
85857	10" x 14"	SS
22915	7" x 10"	PL
22916	10" x 14"	PL
42438	7" x 10"	AL
42439	10" x 14"	AL



122843	7" x 10"	FB
74270	10" x 14"	FB
87790	3.5" x 5"	SS
85858	7" x 10"	SS
85859	10" x 14"	SS
22917	7" x 10"	PL
22918	10" x 14"	PL
42440	7" x 10"	AL
42441	10" x 14"	AL



132090	7" x 10"	FB
132091	10" x 14"	FB
132088	7" x 10"	SS
132089	10" x 14"	SS
132086	7" x 10"	PL
132087	10" x 14"	PL
132084	7" x 10"	AL
132085	10" x 14"	AL



85860	7" x 10"	SS
85861	10" x 14"	SS
22919	7" x 10"	PL
22920	10" x 14"	PL
42442	7" x 10"	AL
42443	10" x 14"	AL



127658	7" x 10"	SS
127661	10" x 14"	SS
127657	7" x 10"	PL
127660	10" x 14"	PL
127656	7" x 10"	AL
127659	10" x 14"	AL



127664	7" x 10"	SS
127667	10" x 14"	SS
127663	7" x 10"	PL
127666	10" x 14"	PL
127662	7" x 10"	AL
127665	10" x 14"	AL



69404	10" x 14"	FB
85083	7" x 10"	SS
85084	10" x 14"	SS
25596	7" x 10"	PL
25597	10" x 14"	PL
43173	7" x 10"	AL
43174	10" x 14"	AL



129056	7" x 10"	SS
129059	10" x 14"	SS
129055	7" x 10"	PL
129058	10" x 14"	PL
129054	7" x 10"	AL
129057	10" x 14"	AL



85866	7" x 10"	SS
85867	10" x 14"	SS
22921	7" x 10"	PL
22922	10" x 14"	PL
42444	7" x 10"	AL
42445	10" x 14"	AL



129062	7" x 10"	SS
129065	10" x 14"	SS
129061	7" x 10"	PL
129064	10" x 14"	PL
129060	7" x 10"	AL
129063	10" x 14"	AL



73444	10" x 14"	FB
84708	7" x 10"	SS
22517	7" x 10"	PL
22518	10" x 14"	PL
41081	7" x 10"	AL
41082	10" x 14"	AL



127670	7" x 10"	SS
127673	10" x 14"	SS
127669	7" x 10"	PL
127672	10" x 14"	PL
127668	7" x 10"	AL
127671	10" x 14"	AL



122845	7" x 10"	FB
70470	10" x 14"	FB
85870	7" x 10"	SS
85871	10" x 14"	SS
22923	7" x 10"	PL
22924	10" x 14"	PL
122409	7" x 10"	AL
42447	10" x 14"	AL

Safety Signs

Machine and Operational Signs

BradyID.com/s36

Machine and Operational Signs (continued)



127676	7" x 10"	SS
127679	10" x 14"	SS
127675	7" x 10"	PL
127678	10" x 14"	PL
127674	7" x 10"	AL
127677	10" x 14"	AL



127682	7" x 10"	SS
127685	10" x 14"	SS
127681	7" x 10"	PL
127684	10" x 14"	PL
127680	7" x 10"	AL
127683	10" x 14"	AL



127688	7" x 10"	SS
127691	10" x 14"	SS
127687	7" x 10"	PL
127690	10" x 14"	PL
127686	7" x 10"	AL
127689	10" x 14"	AL



70527	7" x 10"	FB
70528	10" x 14"	FB
87783	3.5" x 5"	SS
85085	7" x 10"	SS
85086	10" x 14"	SS
25598	7" x 10"	PL
25599	10" x 14"	PL
43175	7" x 10"	AL
43176	10" x 14"	AL

Sign Selection Guide

FB - Premium fiberglass (B-120)
 SS - Self-sticking polyester (B-302)
 PL - Plastic (B-401)
 AL - Aluminum (B-555)
 BGSS - BradyGlo™ self-stick polyester (B-324)
 BGPL - BradyGlo™ plastic (B-347)

Material Comparison page 408
 Sign Legend Index..... page 588



132074	7" x 10"	FB
132075	10" x 14"	FB
132072	7" x 10"	SS
132073	10" x 14"	SS
132070	7" x 10"	PL
132071	10" x 14"	PL
132068	7" x 10"	AL
132069	10" x 14"	AL



129068	7" x 10"	SS
129071	10" x 14"	SS
129067	7" x 10"	PL
129070	10" x 14"	PL
129066	7" x 10"	AL
129069	10" x 14"	AL



47124	10" x 14"	FB
87784	3.5" x 5"	SS
85087	7" x 10"	SS
85088	10" x 14"	SS
25600	7" x 10"	PL
25601	10" x 14"	PL
43177	7" x 10"	AL
43178	10" x 14"	AL



70529	7" x 17"	FB
-------	----------	----



132066	7" x 10"	FB
132067	10" x 14"	FB
132064	7" x 10"	SS
132065	10" x 14"	SS
132062	7" x 10"	PL
132063	10" x 14"	PL
132060	7" x 10"	AL
132061	10" x 14"	AL



129074	7" x 10"	SS
129077	10" x 14"	SS
129073	7" x 10"	PL
129076	10" x 14"	PL
129072	7" x 10"	AL
129075	10" x 14"	AL



41083	7" x 10"	AL
-------	----------	----



127694	7" x 10"	SS
127697	10" x 14"	SS
127693	7" x 10"	PL
127696	10" x 14"	PL
127692	7" x 10"	AL
127695	10" x 14"	AL



127700	7" x 10"	SS
127703	10" x 14"	SS
127699	7" x 10"	PL
127702	10" x 14"	PL
127698	7" x 10"	AL
127701	10" x 14"	AL



74350	7" x 10"	FB
85886	7" x 10"	SS
85887	10" x 14"	SS
22929	7" x 10"	PL
22930	10" x 14"	PL
42452	7" x 10"	AL
42453	10" x 14"	AL



85091	7" x 10"	SS
85092	10" x 14"	SS
25604	7" x 10"	PL
25605	10" x 14"	PL
43181	7" x 10"	AL
43182	10" x 14"	AL



127706	7" x 10"	SS
127709	10" x 14"	SS
127705	7" x 10"	PL
127708	10" x 14"	PL
127704	7" x 10"	AL
127707	10" x 14"	AL



85896	7" x 10"	SS
85897	10" x 14"	SS
22933	7" x 10"	PL
42457	10" x 14"	AL



69531	10" x 14"	FB
85898	7" x 10"	SS
22935	7" x 10"	PL
42458	7" x 10"	AL
42459	10" x 14"	AL



74385	10" x 14"	FB
85093	7" x 10"	SS
85094	10" x 14"	SS
25606	7" x 10"	PL
25607	10" x 14"	PL
43183	7" x 10"	AL
43184	10" x 14"	AL

Safety Signs

Machine and Operational Signs

BradyID.com/s36

Machine and Operational Signs (continued)



70563	10" x 14"	FB
85900	7" x 10"	SS
85901	10" x 14"	SS
22937	7" x 10"	PL



85902	3.5" x 5"	SS
-------	-----------	----



43185	7" x 10"	AL
43186	10" x 14"	AL
74680	7" x 10"	FB
85095	7" x 10"	SS
85096	10" x 14"	SS
25608	7" x 10"	PL
25609	10" x 14"	PL



129092	10" x 7"	SS
129095	14" x 10"	SS
129091	10" x 7"	PL
129094	14" x 10"	PL
129090	10" x 7"	AL
129093	14" x 10"	AL



122848	7" x 10"	FB
122718	10" x 14"	FB
122652	7" x 10"	SS
122577	10" x 14"	SS
122521	7" x 10"	PL
25906	10" x 14"	PL
122411	7" x 10"	AL
43483	10" x 14"	AL



127712	7" x 10"	SS
127715	10" x 14"	SS
127711	7" x 10"	PL
127714	10" x 14"	PL
127710	7" x 10"	AL
127713	10" x 14"	AL



70577	7" x 17"	FB
-------	----------	----



74442	14" x 20"	FB
85903	7" x 10"	SS
85904	10" x 14"	SS
22939	7" x 10"	PL
22940	10" x 14"	PL
42462	7" x 10"	AL
42463	10" x 14"	AL



70579	10" x 14"	FB
85905	7" x 10"	SS
22941	7" x 10"	PL
22942	10" x 14"	PL
42464	7" x 10"	AL
42465	10" x 14"	AL



70580	7" x 17"	FB
25907	10" x 14"	PL
43484	10" x 14"	AL



127718	7" x 10"	SS
127721	10" x 14"	SS
127717	7" x 10"	PL
127720	10" x 14"	PL
127716	7" x 10"	AL
127719	10" x 14"	AL



74455	10" x 14"	FB
87782	3.5" x 5"	SS
85097	7" x 10"	SS
85098	10" x 14"	SS
25610	7" x 10"	PL
25611	10" x 14"	PL
43187	7" x 10"	AL
43188	10" x 14"	AL



132098	7" x 10"	FB
132099	10" x 14"	FB
132096	7" x 10"	SS
132097	10" x 14"	SS
132094	7" x 10"	PL
132095	10" x 14"	PL
132092	7" x 10"	AL
132093	10" x 14"	AL



69551	7" x 17"	FB
-------	----------	----



129080	7" x 10"	SS
129083	10" x 14"	SS
129079	7" x 10"	PL
129082	10" x 14"	PL
129078	7" x 10"	AL
129081	10" x 14"	AL



70587	7" x 17"	FB
-------	----------	----



74509	10" x 14"	FB
85099	7" x 10"	SS
85100	10" x 14"	SS
25612	7" x 10"	PL
25613	10" x 14"	PL
43189	7" x 10"	AL
43190	10" x 14"	AL



Design custom signs online

BradyID.com/customsigns

Machine and Operational Signs

BradyID.com/s36

Machine and Operational Signs (continued)



127802	7" x 10"	SS
127805	10" x 14"	SS
127801	7" x 10"	PL
127804	10" x 14"	PL
127800	7" x 10"	AL
127803	10" x 14"	AL



73009	10" x 14"	FB
85919	7" x 10"	SS
85920	10" x 14"	SS
22945	7" x 10"	PL
22946	10" x 14"	PL
42468	7" x 10"	AL
42469	10" x 14"	AL



127820	7" x 10"	SS
127823	10" x 14"	SS
127819	7" x 10"	PL
127822	10" x 14"	PL
127818	7" x 10"	AL
127821	10" x 14"	AL



127814	7" x 10"	SS
127817	10" x 14"	SS
127813	7" x 10"	PL
127816	10" x 14"	PL
127812	7" x 10"	AL
127815	10" x 14"	AL

Sign Selection Guide

- FB - Premium fiberglass (B-120)
- SS - Self-sticking polyester (B-302)
- PL - Plastic (B-401)
- AL - Aluminum (B-555)
- BGSS - BradyGlo™ self-stick polyester (B-324)
- BGPL - BradyGlo™ plastic (B-347)

Material Comparison page 408
Sign Legend Index..... page 588



69046	10" x 14"	FB
85921	7" x 10"	SS
22948	10" x 14"	PL
42471	10" x 14"	AL



73052	14" x 20"	FB
85923	7" x 10"	SS
85924	10" x 14"	SS
22949	7" x 10"	PL
22950	10" x 14"	PL
42472	7" x 10"	AL
42473	10" x 14"	AL



85925	7" x 10"	SS
85926	10" x 14"	SS



73058	10" x 14"	FB
85927	7" x 10"	SS
85928	10" x 14"	SS
22951	7" x 10"	PL
22952	10" x 14"	PL
42474	7" x 10"	AL
42475	10" x 14"	AL



69075	10" x 14"	FB
85101	7" x 10"	SS
85102	10" x 14"	SS
25614	7" x 10"	PL
25615	10" x 14"	PL
43191	7" x 10"	AL
43192	10" x 14"	AL



127808	7" x 10"	SS
127811	10" x 14"	SS
127807	7" x 10"	PL
127810	10" x 14"	PL
127806	7" x 10"	AL
127809	10" x 14"	AL



85942	10" x 14"	SS
22953	7" x 10"	PL
42476	7" x 10"	AL



73086	7" x 10"	FB
22955	7" x 10"	PL
22956	10" x 14"	PL
42478	7" x 10"	AL

Safety Signs



69131	7" x 17"	FB
-------	----------	----



127856	7" x 10"	SS
127859	10" x 14"	SS
127855	7" x 10"	PL
127858	10" x 14"	PL
127854	7" x 10"	AL
127857	10" x 14"	AL



127868	7" x 10"	SS
127871	10" x 14"	SS
127867	7" x 10"	PL
127870	10" x 14"	PL
127866	7" x 10"	AL
127869	10" x 14"	AL



127838	7" x 10"	SS
127841	10" x 14"	SS
127837	7" x 10"	PL
127840	10" x 14"	PL
127836	7" x 10"	AL
127839	10" x 14"	AL



69144	10" x 14"	FB
85949	7" x 10"	SS
22957	7" x 10"	PL
22958	10" x 14"	PL
42480	7" x 10"	AL
42481	10" x 14"	AL



127862	7" x 10"	SS
127865	10" x 14"	SS
127861	7" x 10"	PL
127864	10" x 14"	PL
127860	7" x 10"	AL
127863	10" x 14"	AL



22960	10" x 14"	PL
-------	-----------	----



69148	10" x 14"	FB
22961	7" x 10"	PL
22962	10" x 14"	PL
42485	10" x 14"	AL



74111	10" x 14"	FB
85959	7" x 10"	SS
85960	10" x 14"	SS
22963	7" x 10"	PL
22964	10" x 14"	PL
42486	7" x 10"	AL
42487	10" x 14"	AL



127844	7" x 10"	SS
127847	10" x 14"	SS
127843	7" x 10"	PL
127846	10" x 14"	PL
127842	7" x 10"	AL
127845	10" x 14"	AL

Machine and Operational Signs

Machine and Operational Signs (continued)



127832	7" x 10"	SS
127835	10" x 14"	SS
127831	7" x 10"	PL
127834	10" x 14"	PL
127830	7" x 10"	AL
127833	10" x 14"	AL



43497	7" x 10"	AL
-------	----------	----



127850	7" x 10"	SS
127853	10" x 14"	SS
127849	7" x 10"	PL
127852	10" x 14"	PL
127848	7" x 10"	AL
127851	10" x 14"	AL



69170	10" x 14"	FB
85973	7" x 10"	SS
85974	10" x 14"	SS
22968	10" x 14"	PL
42490	7" x 10"	AL
42491	10" x 14"	AL



122824	7" x 10"	FB
74132	10" x 14"	FB
85971	7" x 10"	SS
85972	10" x 14"	SS
22965	7" x 10"	PL
22966	10" x 14"	PL
42488	7" x 10"	AL
42489	10" x 14"	AL



70290	7" x 10"	FB
85975	7" x 10"	SS
22970	10" x 14"	PL
42492	7" x 10"	AL
42493	10" x 14"	AL



85979	7" x 10"	SS
22971	7" x 10"	PL
22972	10" x 14"	PL
42494	7" x 10"	AL
42495	10" x 14"	AL



85119	7" x 10"	SS
85120	10" x 14"	SS
25623	10" x 14"	PL
43200	10" x 14"	AL



85985	7" x 10"	SS
85986	10" x 14"	SS
22973	7" x 10"	PL
22974	10" x 14"	PL
42496	7" x 10"	AL
42497	10" x 14"	AL



69237	10" x 14"	FB
85987	7" x 10"	SS
85988	10" x 14"	SS
22975	7" x 10"	PL
22976	10" x 14"	PL
42498	7" x 10"	AL
42499	10" x 14"	AL



122814	7" x 10"	FB
70340	10" x 14"	FB
85989	7" x 10"	SS
85990	10" x 14"	SS
22977	7" x 10"	PL
22978	10" x 14"	PL
42500	7" x 10"	AL
42501	10" x 14"	AL



70363	10" x 14"	FB
85995	7" x 10"	SS
42502	7" x 10"	AL
42503	10" x 14"	AL



73460	7" x 10"	FB
85997	7" x 10"	SS
85998	10" x 14"	SS
22981	7" x 10"	PL
22982	10" x 14"	PL
42504	7" x 10"	AL
42505	10" x 14"	AL



122840	7" x 10"	FB
74187	10" x 14"	FB
88101	7" x 10"	SS
88102	10" x 14"	SS
22983	7" x 10"	PL
22984	10" x 14"	PL
42506	7" x 10"	AL
42507	10" x 14"	AL



127874	7" x 10"	SS
127877	10" x 14"	SS
127873	7" x 10"	PL
127876	10" x 14"	PL
127872	7" x 10"	AL
127875	10" x 14"	AL



122816	7" x 10"	FB
74609	10" x 14"	FB
87788	3.5" x 5"	SS
88107	7" x 10"	SS
88108	10" x 14"	SS
22985	7" x 10"	PL
22986	10" x 14"	PL
42508	7" x 10"	AL
42509	10" x 14"	AL



131877	7" x 10"	FB
131878	10" x 14"	FB
131875	7" x 10"	SS
131876	10" x 14"	SS
131873	7" x 10"	PL
131874	10" x 14"	PL
131871	7" x 10"	AL
131872	10" x 14"	AL



123727	7" x 10"	SS
123730	10" x 14"	SS
123726	7" x 10"	PL
123729	10" x 14"	PL
123725	7" x 10"	AL
123728	10" x 14"	AL



70393	10" x 14"	FB
88109	7" x 10"	SS
22987	7" x 10"	PL
42510	7" x 10"	AL
42511	10" x 14"	AL



69028	7" x 17"	FB
-------	----------	----



127880	7" x 10"	SS
127883	10" x 14"	SS
127879	7" x 10"	PL
127882	10" x 14"	PL
127878	7" x 10"	AL
127881	10" x 14"	AL



69317	10" x 14"	FB
88115	7" x 10"	SS
88116	10" x 14"	SS
22989	7" x 10"	PL



88117	7" x 10"	SS
42514	7" x 10"	AL
42515	10" x 14"	AL



127886	7" x 10"	SS
127889	10" x 14"	SS
127885	7" x 10"	PL
127888	10" x 14"	PL
127884	7" x 10"	AL
127887	10" x 14"	AL



74226	7" x 10"	FB
88119	7" x 10"	SS
88120	10" x 14"	SS
22993	7" x 10"	PL
22994	10" x 14"	PL
42516	7" x 10"	AL



127892	7" x 10"	SS
127895	10" x 14"	SS
127891	7" x 10"	PL
127894	10" x 14"	PL
127890	7" x 10"	AL
127893	10" x 14"	AL



88123	7" x 10"	SS
88124	10" x 14"	SS
22995	7" x 10"	PL
22996	10" x 14"	PL
42518	7" x 10"	AL
42519	10" x 14"	AL



22998	10" x 14"	PL
42521	10" x 14"	AL

Machine and Operational Signs

BradyID.com/s36

Machine and Operational Signs (continued)



69344	10" x 14"	FB
88127	7" x 10"	SS
88128	10" x 14"	SS
23000	10" x 14"	PL
42522	7" x 10"	AL
42523	10" x 14"	AL



123745	7" x 10"	SS
123748	10" x 14"	SS
123744	7" x 10"	PL
123747	10" x 14"	PL
123743	7" x 10"	AL
123746	10" x 14"	AL



74264	10" x 14"	FB
88131	7" x 10"	SS
88132	10" x 14"	SS
23001	7" x 10"	PL
23002	10" x 14"	PL
42524	7" x 10"	AL
42525	10" x 14"	AL



25911	10" x 14"	PL
43488	10" x 14"	AL

Sign Selection Guide

- FB - Premium fiberglass (B-120)
- SS - Self-sticking polyester (B-302)
- PL - Plastic (B-401)
- AL - Aluminum (B-555)
- BGSS - BradyGlo™ self-stick polyester (B-324)
- BGPL - BradyGlo™ plastic (B-347)

Material Comparison page 408
Sign Legend Index..... page 588



23003	7" x 10"	PL
23004	10" x 14"	PL
42526	7" x 10"	AL
42527	10" x 14"	AL



73415	14" x 20"	FB
88135	7" x 10"	SS
23005	7" x 10"	PL
23006	10" x 14"	PL
42528	7" x 10"	AL
42529	10" x 14"	AL



127898	7" x 10"	SS
127901	10" x 14"	SS
127897	7" x 10"	PL
127900	10" x 14"	PL
127896	7" x 10"	AL
127899	10" x 14"	AL



70422	10" x 14"	FB
88137	7" x 10"	SS
88138	10" x 14"	SS
23007	7" x 10"	PL
23008	10" x 14"	PL
42530	7" x 10"	AL
42531	10" x 14"	AL



88141	7" x 10"	SS
88142	10" x 14"	SS
23009	7" x 10"	PL
23010	10" x 14"	PL
42533	10" x 14"	AL



122827	7" x 10"	FB
47022	10" x 14"	FB
87793	3.5" x 5"	SS
88143	7" x 10"	SS
88144	10" x 14"	SS
23011	7" x 10"	PL
23012	10" x 14"	PL
42534	7" x 10"	AL
42535	10" x 14"	AL



71118	20" x 14"	FB
88146	14" x 10"	SS
23013	10" x 7"	PL
23014	14" x 10"	PL
42536	10" x 7"	AL



71120	20" x 14"	FB
42539	14" x 10"	AL
23015	10" x 7"	PL
23016	14" x 10"	PL



127904	7" x 10"	SS
127907	10" x 14"	SS
127903	7" x 10"	PL
127906	10" x 14"	PL
127902	7" x 10"	AL
127905	10" x 14"	AL



88152	7" x 10"	SS
88153	10" x 14"	SS
23019	7" x 10"	PL
23020	10" x 14"	PL
42542	7" x 10"	AL
42543	10" x 14"	AL



127910	7" x 10"	SS
127913	10" x 14"	SS
127909	7" x 10"	PL
127912	10" x 14"	PL
127908	7" x 10"	AL
127911	10" x 14"	AL



88158	7" x 10"	SS
23021	7" x 10"	PL
23022	10" x 14"	PL



70437	7" x 10"	FB
88155	10" x 14"	SS
25815	10" x 14"	PL
43392	10" x 14"	AL



70438	14" x 20"	FB
25816	10" x 14"	PL



127916	7" x 10"	SS
127919	10" x 14"	SS
127915	7" x 10"	PL
127918	10" x 14"	PL
127914	7" x 10"	AL
127917	10" x 14"	AL



123739	7" x 10"	SS
123742	10" x 14"	SS
123738	7" x 10"	PL
123741	10" x 14"	PL
123737	7" x 10"	AL
123740	10" x 14"	AL



74299	7" x 10"	FB
85115	7" x 10"	SS
85116	10" x 14"	SS
25618	7" x 10"	PL
25619	10" x 14"	PL
43195	7" x 10"	AL
43196	10" x 14"	AL



74305	10" x 14"	FB
85117	7" x 10"	SS
85118	10" x 14"	SS
25620	7" x 10"	PL
25621	10" x 14"	PL
43197	7" x 10"	AL
43198	10" x 14"	AL

Safety Signs

Machine and Operational Signs

BradyID.com/s36

Machine and Operational Signs (continued)



69413	10" x 14"	FB
25625	10" x 14"	PL
43202	10" x 14"	AL



70467	7" x 10"	FB
70468	10" x 14"	FB
88160	7" x 10"	SS
88161	10" x 14"	SS
23023	7" x 10"	PL
23024	10" x 14"	PL
42546	7" x 10"	AL
42547	10" x 14"	AL



69417	10" x 14"	FB
88162	7" x 10"	SS
88163	10" x 14"	SS
23025	7" x 10"	PL
23026	10" x 14"	PL
42548	7" x 10"	AL
42549	10" x 14"	AL



88164	7" x 10"	SS
88165	10" x 14"	SS
23027	7" x 10"	PL
23028	10" x 14"	PL
42550	7" x 10"	AL
42551	10" x 14"	AL



127826	7" x 10"	SS
127829	10" x 14"	SS
127825	7" x 10"	PL
127828	10" x 14"	PL
127824	7" x 10"	AL
127827	10" x 14"	AL



127922	7" x 10"	SS
127925	10" x 14"	SS
127921	7" x 10"	PL
127924	10" x 14"	PL
127920	7" x 10"	AL
127923	10" x 14"	AL



122882	7" x 10"	FB
122743	10" x 14"	FB
122678	7" x 10"	SS
122601	10" x 14"	SS
122547	7" x 10"	PL
25913	10" x 14"	PL
122438	7" x 10"	AL
43490	10" x 14"	AL



127928	7" x 10"	SS
127931	10" x 14"	SS
127927	7" x 10"	PL
127930	10" x 14"	PL
127926	7" x 10"	AL
127929	10" x 14"	AL



69475	10" x 14"	FB
23029	7" x 10"	PL
23030	10" x 14"	PL



87669	7" x 10"	FB
87670	10" x 14"	FB
59506	7" x 10"	SS
21335	10" x 14"	SS
59507	7" x 10"	PL
26923	10" x 14"	PL
59508	7" x 10"	AL
21338	10" x 14"	AL



47159	7" x 10"	FB
88172	3.5" x 5"	SS
88173	7" x 10"	SS
88174	10" x 14"	SS
23031	7" x 10"	PL
23032	10" x 14"	PL
42554	7" x 10"	AL
42555	10" x 14"	AL



69504	7" x 17"	FB
-------	----------	----



60576	10" x 14"	SS
60538	10" x 14"	PL
60509	10" x 14"	AL



88175	7" x 10"	SS
88176	10" x 14"	SS
23033	7" x 10"	PL
23034	10" x 14"	PL
42556	7" x 10"	AL
42557	10" x 14"	AL



60575	10" x 14"	SS
60537	10" x 14"	PL
60508	10" x 14"	AL



69510	14" x 20"	FB
88182	10" x 14"	SS
23035	7" x 10"	PL
23036	10" x 14"	PL
42559	10" x 14"	AL



70547	7" x 10"	FB
88183	7" x 10"	SS
88184	10" x 14"	SS
23037	7" x 10"	PL
23038	10" x 14"	PL
42560	7" x 10"	AL



127934	7" x 10"	SS
127937	10" x 14"	SS
127933	7" x 10"	PL
127936	10" x 14"	PL
127932	7" x 10"	AL
127935	10" x 14"	AL



47160	7" x 10"	FB
47192	10" x 14"	FB
87792	3.5" x 5"	SS
88185	7" x 10"	SS
88186	10" x 14"	SS
23039	7" x 10"	PL
23040	10" x 14"	PL
42562	7" x 10"	AL
42563	10" x 14"	AL



123685	7" x 10"	SS
123688	10" x 14"	SS
123684	7" x 10"	PL
123687	10" x 14"	PL
123683	7" x 10"	AL
123686	10" x 14"	AL



131869	7" x 10"	FB
131870	10" x 14"	FB
131867	7" x 10"	SS
131868	10" x 14"	SS
131865	7" x 10"	PL
131866	10" x 14"	PL
131863	7" x 10"	AL
131864	10" x 14"	AL



Machine and Operational Signs

BradyID.com/s36

Machine and Operational Signs (continued)



69540	10" x 14"	FB
88187	7" x 10"	SS
88188	10" x 14"	SS
23041	7" x 10"	PL
42564	7" x 10"	AL



69541	10" x 14"	FB
88189	7" x 10"	SS
23043	7" x 10"	PL
42566	7" x 10"	AL
42567	10" x 14"	AL



47161	7" x 10"	FB
88191	7" x 10"	SS
88192	10" x 14"	SS
23045	7" x 10"	PL
23046	10" x 14"	PL
42568	7" x 10"	AL
42569	10" x 14"	AL



127940	7" x 10"	SS
127943	10" x 14"	SS
127939	7" x 10"	PL
127942	10" x 14"	PL
127938	7" x 10"	AL
127941	10" x 14"	AL

Sign Selection Guide

FB - Premium fiberglass (B-120)
SS - Self-sticking polyester (B-302)
PL - Plastic (B-401)
AL - Aluminum (B-555)
BGSS - BradyGlo™ self-stick polyester (B-324)
BGPL - BradyGlo™ plastic (B-347)
Material Comparison page 408
Sign Legend Index..... page 588



47162	7" x 10"	FB
75928	14" x 20"	FB
88193	7" x 10"	SS
88194	10" x 14"	SS
23047	7" x 10"	PL
23048	10" x 14"	PL
42570	7" x 10"	AL
42571	10" x 14"	AL



128792	7" x 10"	SS
128795	10" x 14"	SS
128791	7" x 10"	PL
128794	10" x 14"	PL
128790	7" x 10"	AL
128793	10" x 14"	AL



129110	7" x 10"	SS
129113	10" x 14"	SS
129109	7" x 10"	PL
129112	10" x 14"	PL
129108	7" x 10"	AL
129111	10" x 14"	AL



Create custom signs for your facility online at BradyID.com



128402	7" x 10"	SS
128405	10" x 14"	SS
128401	7" x 10"	PL
128404	10" x 14"	PL
128400	7" x 10"	AL
128403	10" x 14"	AL



128396	7" x 10"	SS
128399	10" x 14"	SS
128395	7" x 10"	PL
128398	10" x 14"	PL
128394	7" x 10"	AL
128397	10" x 14"	AL



88199	7" x 10"	SS
23051	7" x 10"	PL
23052	10" x 14"	PL



127724	7" x 10"	SS
127727	10" x 14"	SS
127723	7" x 10"	PL
127726	10" x 14"	PL
127722	7" x 10"	AL
127725	10" x 14"	AL



69162	10" x 14"	FB
88205	7" x 10"	SS
88206	10" x 14"	SS
23054	10" x 14"	PL
42576	7" x 10"	AL
42577	10" x 14"	AL



127730	7" x 10"	SS
127733	10" x 14"	SS
127729	7" x 10"	PL
127732	10" x 14"	PL
127728	7" x 10"	AL
127731	10" x 14"	AL



128408	7" x 10"	SS
128411	10" x 14"	SS
128407	7" x 10"	PL
128410	10" x 14"	PL
128406	7" x 10"	AL
128409	10" x 14"	AL



69196	10" x 14"	FB
88208	10" x 14"	SS
23055	7" x 10"	PL
23056	10" x 14"	PL
42578	7" x 10"	AL
42579	10" x 14"	AL



88209	10" x 7"	SS
23057	10" x 7"	PL
23058	14" x 10"	PL



127736	7" x 10"	SS
127739	10" x 14"	SS
127735	7" x 10"	PL
127738	10" x 14"	PL
127734	7" x 10"	AL
127737	10" x 14"	AL



123565	7" x 10"	SS
123568	10" x 14"	SS
123564	7" x 10"	PL
123567	10" x 14"	PL
123563	7" x 10"	AL
123566	10" x 14"	AL



69350	7" x 10"	FB
88215	7" x 10"	SS
88216	10" x 14"	SS
23059	7" x 10"	PL
23060	10" x 14"	PL
42582	7" x 10"	AL
42583	10" x 14"	AL

Safety Signs

Machine and Operational Signs

BradyID.com/s36

Machine and Operational Signs (continued)



88217	7" x 10"	SS
88218	10" x 14"	SS
23061	7" x 10"	PL
23062	10" x 14"	PL
42584	7" x 10"	AL
42585	10" x 14"	AL



70446	7" x 17"	FB
-------	----------	----



70448	7" x 17"	FB
-------	----------	----



129116	7" x 10"	SS
129119	10" x 14"	SS
129115	7" x 10"	PL
129118	10" x 14"	PL
129114	7" x 10"	AL
129117	10" x 14"	AL



70546	10" x 14"	FB
88221	7" x 10"	SS
23063	7" x 10"	PL
23064	10" x 14"	PL
42587	10" x 14"	AL



129122	7" x 10"	SS
129125	10" x 14"	SS
129121	7" x 10"	PL
129124	10" x 14"	PL
129120	7" x 10"	AL
129123	10" x 14"	AL



73450	7" x 10"	FB
88225	7" x 10"	SS
88226	10" x 14"	SS
23065	7" x 10"	PL
23066	10" x 14"	PL
42588	7" x 10"	AL
42589	10" x 14"	AL



127742	7" x 10"	SS
127745	10" x 14"	SS
127741	7" x 10"	PL
127744	10" x 14"	PL
127740	7" x 10"	AL
127743	10" x 14"	AL



127748	7" x 10"	SS
127751	10" x 14"	SS
127747	7" x 10"	PL
127750	10" x 14"	PL
127746	7" x 10"	AL
127749	10" x 14"	AL



69149	10" x 14"	FB
88231	7" x 10"	SS
23069	7" x 10"	PL
23070	10" x 14"	PL
42592	7" x 10"	AL



88234	10" x 14"	SS
23071	7" x 10"	PL
42594	7" x 10"	AL
42595	10" x 14"	AL



127754	7" x 10"	SS
127757	10" x 14"	SS
127753	7" x 10"	PL
127756	10" x 14"	PL
127752	7" x 10"	AL
127755	10" x 14"	AL



127760	7" x 10"	SS
127763	10" x 14"	SS
127759	7" x 10"	PL
127762	10" x 14"	PL
127758	7" x 10"	AL
127761	10" x 14"	AL



85133	7" x 10"	SS
85134	10" x 14"	SS
25630	7" x 10"	PL
25631	10" x 14"	PL
43208	10" x 14"	AL



88237	7" x 10"	SS
88238	10" x 14"	SS
23074	10" x 14"	PL



128444	7" x 10"	SS
128447	10" x 14"	SS
128443	7" x 10"	PL
128446	10" x 14"	PL
128442	7" x 10"	AL
128445	10" x 14"	AL



85135	7" x 10"	SS
85136	10" x 14"	SS
25632	7" x 10"	PL
25633	10" x 14"	PL
43209	7" x 10"	AL
43210	10" x 14"	AL



129128	7" x 10"	SS
129131	10" x 14"	SS
129127	7" x 10"	PL
129130	10" x 14"	PL
129126	7" x 10"	AL
129129	10" x 14"	AL



69561	10" x 14"	FB
88243	7" x 10"	SS
88244	10" x 14"	SS
23077	7" x 10"	PL
23078	10" x 14"	PL
42600	7" x 10"	AL
42601	10" x 14"	AL



69577	10" x 14"	FB
88245	7" x 10"	SS
88246	10" x 14"	SS
23079	7" x 10"	PL
25026	10" x 14"	PL
42602	7" x 10"	AL
42603	10" x 14"	AL



69576	10" x 14"	FB
88247	7" x 10"	SS
88248	10" x 14"	SS
25027	7" x 10"	PL
25028	10" x 14"	PL
42604	7" x 10"	AL
42605	10" x 14"	AL



127766	7" x 10"	SS
127769	10" x 14"	SS
127765	7" x 10"	PL
127768	10" x 14"	PL
127764	7" x 10"	AL
127767	10" x 14"	AL



127772	7" x 10"	SS
127775	10" x 14"	SS
127771	7" x 10"	PL
127774	10" x 14"	PL
127770	7" x 10"	AL
127773	10" x 14"	AL



69588	10" x 14"	FB
88251	7" x 10"	SS
88252	10" x 14"	SS
25029	7" x 10"	PL
25030	10" x 14"	PL
42606	7" x 10"	AL
42607	10" x 14"	AL



69590	10" x 14"	FB
88253	7" x 10"	SS
88254	10" x 14"	SS
25031	7" x 10"	PL
25032	10" x 14"	PL
42608	7" x 10"	AL
42609	10" x 14"	AL



69594	10" x 14"	FB
88255	7" x 10"	SS
88256	10" x 14"	SS
25033	7" x 10"	PL
25034	10" x 14"	PL
42610	7" x 10"	AL
42611	10" x 14"	AL



127778	7" x 10"	SS
127781	10" x 14"	SS
127777	7" x 10"	PL
127780	10" x 14"	PL
127776	7" x 10"	AL
127779	10" x 14"	AL



69595	10" x 14"	FB
88257	7" x 10"	SS
88258	10" x 14"	SS
25035	7" x 10"	PL
42612	7" x 10"	AL
42613	10" x 14"	AL



69596	10" x 14"	FB
88259	7" x 10"	SS
88260	10" x 14"	SS
25037	7" x 10"	PL
25038	10" x 14"	PL
42614	7" x 10"	AL
42615	10" x 14"	AL



127784	7" x 10"	SS
127787	10" x 14"	SS
127783	7" x 10"	PL
127786	10" x 14"	PL
127782	7" x 10"	AL
127785	10" x 14"	AL

Safety Signs

Machine and Operational Signs

BradyID.com/s36

Machine and Operational Signs (continued)



127790	7" x 10"	SS
127793	10" x 14"	SS
127789	7" x 10"	PL
127792	10" x 14"	PL
127788	7" x 10"	AL
127791	10" x 14"	AL



129140	7" x 10"	SS
129143	10" x 14"	SS
129139	7" x 10"	PL
129142	10" x 14"	PL
129138	7" x 10"	AL
129141	10" x 14"	AL



69608	10" x 14"	FB
85139	7" x 10"	SS
85140	10" x 14"	SS
25634	7" x 10"	PL
25635	10" x 14"	PL
43211	7" x 10"	AL
43212	10" x 14"	AL



69609	10" x 14"	FB
85141	7" x 10"	SS
85142	10" x 14"	SS
25636	7" x 10"	PL
25637	10" x 14"	PL
43213	7" x 10"	AL
43214	10" x 14"	AL

Sign Selection Guide

FB - Premium fiberglass (B-120)
SS - Self-sticking polyester (B-302)
PL - Plastic (B-401)
AL - Aluminum (B-555)
BGSS - BradyGlo™ self-stick polyester (B-324)
BGPL - BradyGlo™ plastic (B-347)

Material Comparison page 408
 Sign Legend Index..... page 588



69611	10" x 14"	FB
88267	7" x 10"	SS
88268	10" x 14"	SS
25039	7" x 10"	PL
25040	10" x 14"	PL
42616	7" x 10"	AL
42617	10" x 14"	AL



69614	10" x 14"	FB
85143	7" x 10"	SS
85144	10" x 14"	SS
25638	7" x 10"	PL
25639	10" x 14"	PL
43215	7" x 10"	AL
43216	10" x 14"	AL



127796	7" x 10"	SS
127799	10" x 14"	SS
127795	7" x 10"	PL
127798	10" x 14"	PL
127794	7" x 10"	AL
127797	10" x 14"	AL



123953	10" x 7"	SS
123958	14" x 10"	SS
123952	10" x 7"	PL
123955	14" x 10"	PL
123951	10" x 7"	AL
123954	14" x 10"	AL



88275	7" x 10"	SS
88276	10" x 14"	SS
69791	10" x 14"	FB
25041	7" x 10"	PL
42618	7" x 10"	AL



128216	7" x 10"	SS
128219	10" x 14"	SS
128215	7" x 10"	PL
128218	10" x 14"	PL
128214	7" x 10"	AL
128217	10" x 14"	AL



128342	7" x 10"	SS
128345	10" x 14"	SS
128341	7" x 10"	PL
128344	10" x 14"	PL
128340	7" x 10"	AL
128343	10" x 14"	AL



69080	10" x 10"	FB
88494	10" x 10"	SS
42737	10" x 14"	AL



88281	7" x 10"	SS
25043	10" x 14"	PL
42619	7" x 10"	AL
42620	10" x 14"	AL



90524	10" x 7"	BGSS
-------	----------	------



88283	3.5" x 10"	SS
-------	------------	----



88285	3.5" x 10"	SS
-------	------------	----



127952	7" x 10"	SS
127955	10" x 14"	SS
127951	7" x 10"	PL
127954	10" x 14"	PL
127950	7" x 10"	AL
127953	10" x 14"	AL



70315	7" x 10"	FB
88288	7" x 10"	SS
88293	10" x 14"	SS
25044	7" x 10"	PL
25045	10" x 14"	PL
42621	7" x 10"	AL
42622	10" x 14"	AL



123853	7" x 10"	SS
123856	10" x 14"	SS
123852	7" x 10"	PL
123855	10" x 14"	PL
123851	7" x 10"	AL
123854	10" x 14"	AL



127958	7" x 10"	SS
127961	10" x 14"	SS
127957	7" x 10"	PL
127960	10" x 14"	PL
127956	7" x 10"	AL
127959	10" x 14"	AL



88298	10" x 7"	SS
88299	14" x 10"	SS
25048	10" x 7"	PL
25049	14" x 10"	PL
42626	14" x 10"	AL

Safety Signs



128360	7" x 10"	SS
128363	10" x 14"	SS
128359	7" x 10"	PL
128362	10" x 14"	PL
128358	7" x 10"	AL
128361	10" x 14"	AL



128348	7" x 10"	SS
128351	10" x 14"	SS
128347	7" x 10"	PL
128350	10" x 14"	PL
128346	7" x 10"	AL
128349	10" x 14"	AL



128354	7" x 10"	SS
128357	10" x 14"	SS
128353	7" x 10"	PL
128356	10" x 14"	PL
128352	7" x 10"	AL
128355	10" x 14"	AL



129146	10" x 7"	SS
129149	14" x 10"	SS
129145	10" x 7"	PL
129148	14" x 10"	PL
129144	10" x 7"	AL
129147	14" x 10"	AL

Machine and Operational Signs

BradyID.com/s36

Machine and Operational Signs (continued)



123865	7" x 10"	SS
123868	10" x 14"	SS
123864	7" x 10"	PL
123867	10" x 14"	PL
123863	7" x 10"	AL
123866	10" x 14"	AL



88513	7" x 7"	SS
25177	7" x 10"	PL
42754	7" x 10"	AL



129152	10" x 7"	SS
129155	14" x 10"	SS
129151	10" x 7"	PL
129154	14" x 10"	PL
129150	10" x 7"	AL
129153	14" x 10"	AL



88305	3.5" x 10"	SS
-------	------------	----



69416	10" x 14"	FB
88310	7" x 10"	SS
88311	10" x 14"	SS
25050	7" x 10"	PL
25051	10" x 14"	PL
42627	7" x 10"	AL
42628	10" x 14"	AL



127964	7" x 10"	SS
127967	10" x 14"	SS
127963	7" x 10"	PL
127966	10" x 14"	PL
127962	7" x 10"	AL
127965	10" x 14"	AL



128288	7" x 10"	SS
128291	10" x 14"	SS
128287	7" x 10"	PL
128290	10" x 14"	PL
128286	7" x 10"	AL
128289	10" x 14"	AL



123841	10" x 7"	SS
123844	14" x 10"	SS
123840	10" x 7"	PL
123843	14" x 10"	PL
123839	10" x 7"	AL
123842	14" x 10"	AL



128390	7" x 10"	SS
128393	10" x 14"	SS
128389	7" x 10"	PL
128392	10" x 14"	PL
128388	7" x 10"	AL
128391	10" x 14"	AL

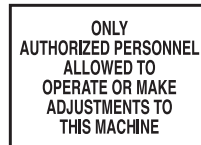

88307	3.5" x 10"	SS
-------	------------	----

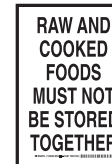

128324	10" x 7"	SS
128327	14" x 10"	SS
128323	10" x 7"	PL
128326	14" x 10"	PL
128322	10" x 7"	AL
128325	14" x 10"	AL



69460	10" x 14"	FB
88314	7" x 10"	SS
88315	10" x 14"	SS
42632	10" x 14"	AL



123847	7" x 10"	SS
123850	10" x 14"	SS
123846	7" x 10"	PL
123849	10" x 14"	PL
123845	7" x 10"	AL
123848	10" x 14"	AL



123835	7" x 10"	SS
123838	10" x 14"	SS
123834	7" x 10"	PL
123837	10" x 14"	PL
123833	7" x 10"	AL
123836	10" x 14"	AL



69430	10" x 10"	FB
88521	10" x 10"	SS
25183	10" x 14"	PL
42760	10" x 14"	AL



69456	10" x 14"	FB
88312	7" x 10"	SS
25052	7" x 10"	PL
25053	10" x 14"	PL
42630	10" x 14"	AL



127946	7" x 10"	SS
127949	10" x 14"	SS
127945	7" x 10"	PL
127948	10" x 14"	PL
127944	7" x 10"	AL
127947	10" x 14"	AL



88323	3.5" x 10"	SS
-------	------------	----



88317	3.5" x 10"	SS
-------	------------	----



88318	7" x 10"	SS
-------	----------	----



128366	7" x 10"	SS
128369	10" x 14"	SS
128365	7" x 10"	PL
128368	10" x 14"	PL
128364	7" x 10"	AL
128367	10" x 14"	AL



128378	7" x 10"	SS
128381	10" x 14"	SS
128377	7" x 10"	PL
128380	10" x 14"	PL
128376	7" x 10"	AL
128379	10" x 14"	AL



128372	7" x 10"	SS
128375	10" x 14"	SS
128371	7" x 10"	PL
128374	10" x 14"	PL
128370	7" x 10"	AL
128373	10" x 14"	AL



85145	3.5" x 10"	SS
-------	------------	----



74415	7" x 10"	FB
88324	7" x 10"	SS
88325	10" x 14"	SS
25058	10" x 14"	PL
42634	7" x 10"	AL
42635	10" x 14"	AL



74429	10" x 14"	FB
88326	3.5" x 10"	SS
88327	7" x 10"	SS
88328	10" x 14"	SS
42636	7" x 10"	AL

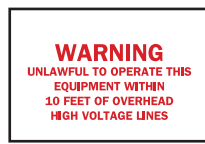

88329	7" x 10"	SS
88330	10" x 14"	SS



85147	3.5" x 10"	SS
-------	------------	----



69238	10" x 10"	FB
88503	10" x 10"	SS
25168	10" x 14"	PL
42745	10" x 14"	AL

Maintenance Signs

BradyID.com/s36

Maintenance Signs

Brady maintenance signs remind employees to follow good housekeeping practices and help manage and sustain a clean and safe workplace. Brady offers more than 250 maintenance signs, each featuring a unique legend or pictogram.



69783	10" x 14"	FB
85572	7" x 10"	SS
85573	10" x 14"	SS
25747	7" x 10"	PL
25748	10" x 14"	PL
43324	7" x 10"	AL
43325	10" x 14"	AL



85580	7" x 10"	SS
85581	10" x 14"	SS
25751	7" x 10"	PL
25752	10" x 14"	PL
43328	7" x 10"	AL
43329	10" x 14"	AL



69307	10" x 14"	FB
85582	7" x 10"	SS
85583	10" x 14"	SS
25753	7" x 10"	PL
25754	10" x 14"	PL
43331	10" x 14"	AL



73443	10" x 14"	FB
85584	7" x 10"	SS
25755	7" x 10"	PL
43332	7" x 10"	AL
43333	10" x 14"	AL



25758	10" x 14"	PL
-------	-----------	----



47115	10" x 14"	FB
85592	7" x 10"	SS
85593	10" x 14"	SS
25759	7" x 10"	PL
25760	10" x 14"	PL
43336	7" x 10"	AL
43337	10" x 14"	AL



122835	7" x 10"	FB
72975	10" x 14"	FB
85598	7" x 10"	SS
85599	10" x 14"	SS
22772	7" x 10"	PL
22773	10" x 14"	PL
41336	7" x 10"	AL
41337	10" x 14"	AL



73439	18" x 12"	FB
-------	-----------	----



85604	7" x 10"	SS
85605	10" x 14"	SS
22776	7" x 10"	PL
22777	10" x 14"	PL



69087	10" x 14"	FB
85606	7" x 10"	SS
85607	10" x 14"	SS
41342	7" x 10"	AL



85610	7" x 10"	SS
22780	7" x 10"	PL



85614	7" x 10"	SS
22782	7" x 10"	PL



85620	7" x 10"	SS
22785	10" x 14"	PL
41348	7" x 10"	AL
41349	10" x 14"	AL



128414	7" x 10"	SS
128417	10" x 14"	SS
128413	7" x 10"	PL
128416	10" x 14"	PL
128412	7" x 10"	AL
128415	10" x 14"	AL



69012	10" x 14"	FB
85629	10" x 14"	SS
22790	7" x 10"	PL



69013	10" x 14"	FB
85631	10" x 14"	SS
22793	10" x 14"	PL
41357	10" x 14"	AL



85632	7" x 10"	SS
85633	10" x 14"	SS
22794	7" x 10"	PL
22795	10" x 14"	PL
41359	10" x 14"	AL



85634	7" x 10"	SS
22796	7" x 10"	PL
22797	10" x 14"	PL
41360	7" x 10"	AL



128420	7" x 10"	SS
128423	10" x 14"	SS
128419	7" x 10"	PL
128422	10" x 14"	PL
128418	7" x 10"	AL
128421	10" x 14"	AL



85642	7" x 10"	SS
85643	10" x 14"	SS
22800	7" x 10"	PL
22801	10" x 14"	PL
41364	7" x 10"	AL
41365	10" x 14"	AL

Sign Selection Guide

FB - Premium fiberglass (B-120)
SS - Self-sticking polyester (B-302)
PL - Plastic (B-401)
AL - Aluminum (B-555)
BGSS - BradyGlo™ self-stick polyester (B-324)
BGPL - BradyGlo™ plastic (B-347)

Material Comparison page 408
Sign Legend Index..... page 588

Regulations

Do Not Enter Lunchroom 29 CFR 1926.62(i)(4)

The employer shall assure that employees do not enter lunchroom facilities or eating areas with protective work clothing or equipment unless surface lead dust has been removed by vacuuming, downdraft booth, other cleaning method that limits dispersion of lead dust.

Housekeeping, Keeping the Aisles Clean 29 CFR 1910.22(a)(1)-(2)

Every workplace, including aisles, storerooms and service rooms must be kept clean and orderly, and in a sanitary condition. Work room floors should be kept dry, with adequate drainage provided.

No Food or Drink Beyond This Point 1910.141(g)

No employee shall be allowed to consume food or beverages in an area exposed to toxic material or in a toilet room.

Load Rating Plate 1910.22(d)

Every building or structure used for mercantile, business, industrial or storage purposes, the loads approved by the building official shall be marked on plates of approved design and shall be affixed by the owner of the building, or his authorized agent, in a conspicuous place in each space to which they relate.

Safety Signs

Maintenance Signs (continued)



85648	7" x 10"	SS
85649	10" x 14"	SS
22804	7" x 10"	PL
22805	10" x 14"	PL
41368	7" x 10"	AL
41369	10" x 14"	AL



85650	7" x 10"	SS
22806	7" x 10"	PL
22807	10" x 14"	PL
41370	7" x 10"	AL
41371	10" x 14"	AL



69455	10" x 14"	FB
85652	7" x 10"	SS
85653	10" x 14"	SS
22808	7" x 10"	PL
22809	10" x 14"	PL
41372	7" x 10"	AL
41373	10" x 14"	AL



47337	14" x 10"	FB
85654	10" x 7"	SS
85655	14" x 10"	SS
22810	10" x 7"	PL
22811	14" x 10"	PL
41374	10" x 7"	AL
41375	14" x 10"	AL



122856	7" x 10"	FB
72623	10" x 14"	FB
122655	7" x 10"	SS
85659	10" x 14"	SS
122524	7" x 10"	PL
22813	10" x 14"	PL
122416	7" x 10"	AL
42336	10" x 14"	AL



85662	7" x 10"	SS
85663	10" x 14"	SS



87715	10" x 14"	FB
56691	10" x 14"	SS
30544	10" x 14"	PL



85664	7" x 10"	SS
22816	7" x 10"	PL
42339	7" x 10"	AL
43352	10" x 14"	AL



87716	10" x 14"	FB
47526	10" x 14"	SS
47518	10" x 14"	PL



72808	7" x 10"	FB
85667	10" x 14"	SS
85666	7" x 10"	SS
22817	7" x 10"	PL
22818	10" x 14"	PL
42340	7" x 10"	AL
42341	10" x 14"	AL



87717	10" x 14"	FB
47550	10" x 14"	SS
47532	10" x 14"	PL
47533	10" x 14"	AL



42341	10" x 14"	AL
85668	7" x 10"	SS
85669	10" x 14"	SS
22819	7" x 10"	PL
22820	10" x 14"	PL
42342	7" x 10"	AL
42343	10" x 14"	AL



78227	14" x 20"	FB
85670	7" x 10"	SS
85671	10" x 14"	SS
22821	7" x 10"	PL
22822	10" x 14"	PL
42344	7" x 10"	AL
42345	10" x 14"	AL



87736	10" x 14"	FB
47618	10" x 14"	PL
57080	10" x 14"	AL



128432	7" x 10"	SS
128435	10" x 14"	SS
128431	7" x 10"	PL
128434	10" x 14"	PL
128430	7" x 10"	AL
128433	10" x 14"	AL



128438	7" x 10"	SS
128441	10" x 14"	SS
128437	7" x 10"	PL
128440	10" x 14"	PL
128436	7" x 10"	AL
128439	10" x 14"	AL



22823	7" x 10"	PL
22824	10" x 14"	PL
42346	7" x 10"	AL



69143	10" x 14"	FB
85686	7" x 10"	SS
85687	10" x 14"	SS
22825	7" x 10"	PL



69282	10" x 14"	FB
85692	7" x 10"	SS
22828	7" x 10"	PL
22829	10" x 14"	PL



69364	10" x 14"	FB
85690	7" x 10"	SS
85691	10" x 14"	SS
22827	7" x 10"	PL
42350	7" x 10"	AL



128192	7" x 10"	SS
128195	10" x 14"	SS
128191	7" x 10"	PL
128194	10" x 14"	PL
128190	7" x 10"	AL
128193	10" x 14"	AL



128198	7" x 10"	SS
128201	10" x 14"	SS
128197	7" x 10"	PL
128200	10" x 14"	PL
128196	7" x 10"	AL
128199	10" x 14"	AL



128204	7" x 10"	SS
128207	10" x 14"	SS
128203	7" x 10"	PL
128206	10" x 14"	PL
128202	7" x 10"	AL
128205	10" x 14"	AL



128222	7" x 10"	SS
128225	10" x 14"	SS
128221	7" x 10"	PL
128224	10" x 14"	PL
128220	7" x 10"	AL
128223	10" x 14"	AL



128210	7" x 10"	SS
128213	10" x 14"	SS
128209	7" x 10"	PL
128212	10" x 14"	PL
128208	7" x 10"	AL
128211	10" x 14"	AL



47116	14" x 10"	FB
85694	10" x 7"	SS
42353	10" x 7"	AL
42354	14" x 10"	AL



69044	10" x 14"	FB
85696	7" x 10"	SS
85697	10" x 14"	SS
22832	7" x 10"	PL



85703	10" x 14"	SS
22833	7" x 10"	PL
42356	7" x 10"	AL



128228	7" x 10"	SS
128231	10" x 14"	SS
128227	7" x 10"	PL
128230	10" x 14"	PL
128226	7" x 10"	AL
128229	10" x 14"	AL



128234	10" x 7"	SS
128237	14" x 10"	SS
128233	10" x 7"	PL
128236	14" x 10"	PL
128232	10" x 7"	AL
128235	14" x 10"	AL

Maintenance Signs

BradyID.com/s36

Maintenance Signs (continued)



128240	7" x 10"	SS
128243	10" x 14"	SS
128239	7" x 10"	PL
128242	10" x 14"	PL
128238	7" x 10"	AL
128241	10" x 14"	AL



85706	7" x 10"	SS
85707	10" x 14"	SS
22834	7" x 10"	PL
42357	7" x 10"	AL



72655	14" x 20"	FB
85708	7" x 10"	SS
85709	10" x 14"	SS
22835	7" x 10"	PL
22836	10" x 14"	PL



128246	7" x 10"	SS
128249	10" x 14"	SS
128245	7" x 10"	PL
128248	10" x 14"	PL
128244	7" x 10"	AL
128247	10" x 14"	AL

Sign Selection Guide

- FB** - Premium fiberglass (B-120)
- SS** - Self-sticking polyester (B-302)
- PL** - Plastic (B-401)
- AL** - Aluminum (B-555)
- BGSS** - BradyGlo™ self-stick polyester (B-324)
- BGPL** - BradyGlo™ plastic (B-347)

Material Comparison page 408
Sign Legend Index..... page 588



128252	7" x 10"	SS
128255	10" x 14"	SS
128251	7" x 10"	PL
128254	10" x 14"	PL
128250	7" x 10"	AL
128253	10" x 14"	AL



128258	10" x 7"	SS
128261	14" x 10"	SS
128257	10" x 7"	PL
128260	14" x 10"	PL
128256	10" x 7"	AL
128259	14" x 10"	AL



128264	7" x 10"	SS
128267	10" x 14"	SS
128263	7" x 10"	PL
128266	10" x 14"	PL
128262	7" x 10"	AL
128265	10" x 14"	AL



70378	7" x 10"	FB
85717	10" x 14"	SS
22839	7" x 10"	PL
42362	7" x 10"	AL



128270	7" x 10"	SS
128273	10" x 14"	SS
128269	7" x 10"	PL
128272	10" x 14"	PL
128268	7" x 10"	AL
128271	10" x 14"	AL



72752	7" x 10"	FB
22840	7" x 10"	PL
22841	10" x 14"	PL
42363	7" x 10"	AL



128276	7" x 10"	SS
128279	10" x 14"	SS
128275	7" x 10"	PL
128278	10" x 14"	PL
128274	7" x 10"	AL
128277	10" x 14"	AL



72800	7" x 10"	FB
122721	10" x 14"	FB
85720	7" x 10"	SS
85721	10" x 14"	SS
22842	7" x 10"	PL
122474	10" x 14"	PL
42365	7" x 10"	AL
122350	10" x 14"	AL



85722	3.5" x 10"	SS
-------	------------	----



128282	7" x 10"	SS
128285	10" x 14"	SS
128281	7" x 10"	PL
128284	10" x 14"	PL
128280	7" x 10"	AL
128283	10" x 14"	AL



122860	7" x 10"	FB
70436	10" x 14"	FB
85723	7" x 10"	SS
85724	10" x 14"	SS
22843	7" x 10"	PL
22844	10" x 14"	PL
122417	7" x 10"	AL
42367	10" x 14"	AL



22845	7" x 10"	PL
22846	10" x 14"	PL
42368	7" x 10"	AL
42369	10" x 14"	AL



73419	7" x 10"	FB
85730	10" x 14"	SS
22847	7" x 10"	PL



85733	7" x 10"	SS
22849	7" x 10"	PL
22850	10" x 14"	PL
42372	7" x 10"	AL
42373	10" x 14"	AL



128294	7" x 10"	SS
128297	10" x 14"	SS
128293	7" x 10"	PL
128296	10" x 14"	PL
128292	7" x 10"	AL
128295	10" x 14"	AL



128300	7" x 10"	SS
128303	10" x 14"	SS
128299	7" x 10"	PL
128302	10" x 14"	PL
128298	7" x 10"	AL
128301	10" x 14"	AL



128306	7" x 10"	SS
128309	10" x 14"	SS
128305	7" x 10"	PL
128308	10" x 14"	PL
128304	7" x 10"	AL
128307	10" x 14"	AL



69444	10" x 14"	FB
85737	7" x 10"	SS
85738	10" x 14"	SS
22851	7" x 10"	PL
22852	10" x 14"	PL
42375	10" x 14"	AL



85741	7" x 10"	SS
22853	7" x 10"	PL
22854	10" x 14"	PL



72949	10" x 14"	FB
22855	7" x 10"	PL
22856	10" x 14"	PL
42378	7" x 10"	AL



85750	7" x 10"	SS
85751	10" x 14"	SS
22857	7" x 10"	PL
42380	7" x 10"	AL

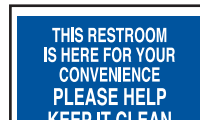

85752	7" x 10"	SS
85753	10" x 14"	SS
22858	7" x 10"	PL
42381	7" x 10"	AL



128336	7" x 10"	SS
128339	10" x 14"	SS
128335	7" x 10"	PL
128338	10" x 14"	PL
128334	7" x 10"	AL
128337	10" x 14"	AL



128318	10" x 7"	SS
128321	14" x 10"	SS
128317	10" x 7"	PL
128320	14" x 10"	PL
128316	10" x 7"	AL
128319	14" x 10"	AL



85745	7" x 10"	SS
85746	10" x 14"	SS

Black on white		
128318	10" x 7"	SS

Safety Signs

No Cellular Phones / No Firearms Signs

BradyID.com/s36

No Cellular Phones Signs

Brady signs communicate the prohibited use of cell phones and two-way radios where the radio frequency, noise or distraction is a concern, including blasting areas, quiet rooms, hospitals and other sensitive areas.

95501 10" x 14" PL	95500 10" x 14" PL	95499 10" x 14" PL	95498 10" x 14" PL
132039 7" x 10" FB	122877 7" x 10" FB	122878 7" x 10" FB	132032 7" x 10" FB
132040 10" x 14" FB	122738 10" x 14" FB	122739 10" x 14" FB	132033 10" x 14" FB
132037 7" x 10" SS	122673 7" x 10" SS	122674 7" x 10" SS	132030 7" x 10" SS
132038 10" x 14" SS	122596 10" x 14" SS	122597 10" x 14" SS	132031 10" x 14" SS
132036 7" x 10" PL	122542 7" x 10" PL	122543 7" x 10" PL	132029 7" x 10" PL
132034 7" x 10" AL	95503 10" x 14" PL	95502 10" x 14" PL	132027 7" x 10" AL
132035 10" x 14" AL	95410 14" x 10" PL	122434 7" x 10" AL	132028 10" x 14" AL
	122433 7" x 10" AL	122366 10" x 14" AL	122366 10" x 14" AL
	122365 10" x 14" AL		



No Firearms / Concealed Carry Signs

Concealed Carry signs help indicate weapon policies within private businesses and public facilities. Establishments such as restaurants, bars, certain government buildings and more can post signs to prohibit guns in their buildings.

84908 10" x 14" SS	122868 7" x 10" FB	123550 14" x 10" SS	123544 14" x 10" SS
23092 10" x 14" PL	70632 10" x 14" FB	123547 10" x 7" SS	123541 10" x 7" SS
84907 10" x 14" AL	80037 7" x 10" SS	123549 14" x 10" PL	123543 14" x 10" PL
	122622 10" x 14" SS	123546 10" x 7" PL	123540 10" x 7" PL
	25977 7" x 10" PL	123548 14" x 10" AL	123542 14" x 10" AL
	25978 10" x 14" PL	123545 10" x 7" AL	123539 10" x 7" AL
	122459 7" x 10" AL		
	43906 10" x 14" AL		
141797 12" x 18" AL	Illinois Gun Law Sign	Nebraska Gun Law Sign	Texas Gun Law Sign
	139798 4" x 6" B-595	104061 10" x 7" SS	148137 20" x 28" SS
	139797 5" x 7" PL	104064 14" x 10" PL	148139 14" x 10" AL



Safety Signs

No Smoking Signs

BradyID.com/s36

No Smoking / Smoking Area Signs

Brady smoking signs communicate to employees and visitors areas where smoking is prohibited or where designated smoking areas are located. Brady has signs in various sizes and materials for indoor and outdoor use.

Sign Selection Guide

- FB** - Premium fiberglass (B-120)
- SS** - Self-sticking polyester (B-302)
- PL** - Plastic (B-401)
- AL** - Aluminum (B-555)
- BGSS** - BradyGlo™ self-stick polyester (B-324)
- BGPL** - BradyGlo™ plastic (B-347)

Material Comparison page 408
Sign Legend Index..... page 588



128108	7" x 10"	SS
128111	10" x 14"	SS
128107	7" x 10"	PL
128110	10" x 14"	PL
128106	7" x 10"	AL
128109	10" x 14"	AL



72285	14" x 20"	FB
88345	7" x 10"	SS
88346	10" x 14"	SS
25060	7" x 10"	PL
25061	10" x 14"	PL
42637	7" x 10"	AL
42638	10" x 14"	AL



72072	14" x 20"	FB
88347	7" x 10"	SS
88348	10" x 14"	SS
25062	7" x 10"	PL
25063	10" x 14"	PL
42639	7" x 10"	AL
42640	10" x 14"	AL



128102	7" x 10"	SS
128105	10" x 14"	SS
128101	7" x 10"	PL
128104	10" x 14"	PL
128100	7" x 10"	AL
128103	10" x 14"	AL



88351	7" x 10"	SS
88352	10" x 14"	SS
25064	7" x 10"	PL
25065	10" x 14"	PL
42641	7" x 10"	AL
42642	10" x 14"	AL



128132	7" x 10"	SS
128135	10" x 14"	SS
128131	7" x 10"	PL
128134	10" x 14"	PL
128130	7" x 10"	AL
128133	10" x 14"	AL



128120	7" x 10"	SS
128123	10" x 14"	SS
128119	7" x 10"	PL
128122	10" x 14"	PL
128118	7" x 10"	AL
128121	10" x 14"	AL



128138	7" x 10"	SS
128141	10" x 14"	SS
128137	7" x 10"	PL
128140	10" x 14"	PL
128136	7" x 10"	AL
128139	10" x 14"	AL



128126	7" x 10"	SS
128129	10" x 14"	SS
128125	7" x 10"	PL
128128	10" x 14"	PL
128124	7" x 10"	AL
128127	10" x 14"	AL



73437	10" x 14"	FB
85189	7" x 10"	SS
85190	10" x 14"	SS
25672	7" x 10"	PL
25673	10" x 14"	PL
43249	7" x 10"	AL
43250	10" x 14"	AL



88363	10" x 7"	SS
88364	14" x 10"	SS
25073	14" x 10"	PL
42649	10" x 7"	AL
42650	14" x 10"	AL



47171	7" x 10"	FB
47010	10" x 14"	FB
88369	3.5" x 5"	SS
88370	7" x 10"	SS
88371	10" x 14"	SS
25076	7" x 10"	PL
25077	10" x 14"	PL
42653	7" x 10"	AL
42654	10" x 14"	AL



44545	6" x 6"	B-447
-------	---------	-------



132003	7" x 10"	FB
132004	10" x 14"	FB
132001	7" x 10"	SS
132002	10" x 14"	SS
132000	7" x 10"	PL
25912	10" x 14"	PL
131999	7" x 10"	AL
43489	10" x 14"	AL



95269	7" x 17"	FB
-------	----------	----



73416	7" x 17"	FB
-------	----------	----



72083	14" x 20"	FB
88374	7" x 10"	SS
88375	10" x 14"	SS
25078	7" x 10"	PL
25079	10" x 14"	PL
42655	7" x 10"	AL
42656	10" x 14"	AL



70452	7" x 17"	FB
-------	----------	----

Regulations

No Smoking 1910.106(e)(6)(i)

Adequate precautions shall be taken to prevent the ignition of flammable vapors. Sources of ignition include but are not limited to open flames; lightning; smoking...

Battery Charging Area 1910.178(g)(1)

Battery charging installations shall be located in areas designated for that purpose.

Hydrogen Marking 1910.103(b)(1)(v)

Hydrogen storage location shall be permanently placarded as follows: "HYDROGEN - FLAMMABLE GAS - NO SMOKING - NO OPEN FLAMES," or equivalent.

No Smoking, No Open Flames 1910.106(d)(7)(iii)

Open flames and smoking shall not be permitted in flammable liquid storage areas.

No Smoking Signs (continued)



143471	7" x 10"	SS
143472	10" x 14"	SS
143469	7" x 10"	PL
143470	10" x 14"	PL
143467	7" x 10"	AL
143468	10" x 14"	AL



131785	7" x 10"	FB
131786	10" x 14"	FB
131783	7" x 10"	SS
131784	10" x 14"	SS
131781	7" x 10"	PL
131782	10" x 14"	PL
131779	7" x 10"	AL
131780	10" x 14"	AL



143477	7" x 10"	SS
143478	10" x 14"	SS
143475	7" x 10"	PL
143476	10" x 14"	PL
143473	7" x 10"	AL
143474	10" x 14"	AL



128144	7" x 10"	SS
128147	10" x 14"	SS
128143	7" x 10"	PL
128146	10" x 14"	PL
128142	7" x 10"	AL
128145	10" x 14"	AL



122817	7" x 10"	FB
47203	10" x 14"	FB
75670	14" x 20"	FB
88376	7" x 10"	SS
88377	10" x 14"	SS
25080	7" x 10"	PL
25081	10" x 14"	PL
42657	7" x 10"	AL
42658	10" x 14"	AL
95154	10" x 14"	Reflective



131737	7" x 10"	FB
131738	10" x 14"	FB
131735	7" x 10"	SS
131736	10" x 14"	SS
131733	7" x 10"	PL
131734	10" x 14"	PL
131731	7" x 10"	AL
131732	10" x 14"	AL



122818	7" x 10"	FB
72118	10" x 14"	FB
87796	3.5" x 5"	SS
88378	7" x 10"	SS
88379	10" x 14"	SS
25082	7" x 10"	PL
25083	10" x 14"	PL
42659	7" x 10"	AL
42660	10" x 14"	AL



43504	10" x 14"	AL
-------	-----------	----



143494	10" x 14"	FB
143491	14" x 20"	FB
143493	7" x 10"	SS
143496	10" x 14"	SS
143495	10" x 14"	PL
143492	7" x 10"	AL
143497	10" x 14"	AL



72133	14" x 20"	FB
88380	7" x 10"	SS
88381	10" x 14"	SS
25084	7" x 10"	PL
25085	10" x 14"	PL
42661	7" x 10"	AL
42662	10" x 14"	AL



73466	10" x 14"	FB
88382	7" x 10"	SS
88383	10" x 14"	SS
25086	7" x 10"	PL
25087	10" x 14"	PL
42663	7" x 10"	AL
42664	10" x 14"	AL



128150	7" x 10"	SS
128153	10" x 14"	SS
128149	7" x 10"	PL
128152	10" x 14"	PL
128148	7" x 10"	AL
128151	10" x 14"	AL



143483	7" x 10"	SS
143484	10" x 14"	SS
143481	7" x 10"	PL
143482	10" x 14"	PL
143479	7" x 10"	AL
143480	10" x 14"	AL



143489	7" x 10"	SS
143490	10" x 14"	SS
143487	7" x 10"	PL
143488	10" x 14"	PL
143485	7" x 10"	AL
143486	10" x 14"	AL



128156	7" x 10"	SS
128159	10" x 14"	SS
128155	7" x 10"	PL
128158	10" x 14"	PL
128154	7" x 10"	AL
128157	10" x 14"	AL



88384	7" x 10"	SS
25088	7" x 10"	PL
25089	10" x 14"	PL
42665	7" x 10"	AL
42666	10" x 14"	AL



70509	7" x 17"	FB
-------	----------	----



72342	10" x 14"	FB
88449	7" x 10"	SS
88450	10" x 14"	SS
25132	7" x 10"	PL
25133	10" x 14"	PL
42710	10" x 14"	AL



88386	7" x 10"	SS
88387	10" x 14"	SS
25090	7" x 10"	PL
25091	10" x 14"	PL
42667	7" x 10"	AL



128162	7" x 10"	SS
128165	10" x 14"	SS
128161	7" x 10"	PL
128164	10" x 14"	PL
128160	7" x 10"	AL
128163	10" x 14"	AL



88388	7" x 10"	SS
88389	10" x 14"	SS
25092	7" x 10"	PL
25093	10" x 14"	PL
42669	7" x 10"	AL
42670	10" x 14"	AL



128168	7" x 10"	SS
128171	10" x 14"	SS
128167	7" x 10"	PL
128170	10" x 14"	PL
128166	7" x 10"	AL
128169	10" x 14"	AL



73427	10" x 14"	FB
84177	7" x 10"	SS
84178	10" x 14"	SS
22179	7" x 10"	PL
22180	10" x 14"	PL
40744	10" x 14"	AL



88394	7" x 10"	SS
25097	10" x 14"	PL
42674	10" x 14"	AL



69568	10" x 14"	FB
88396	7" x 10"	SS
88397	10" x 14"	SS
25098	7" x 10"	PL
25099	10" x 14"	PL
42675	7" x 10"	AL
42676	10" x 14"	AL



69599	10" x 14"	FB
88400	7" x 10"	SS
88401	10" x 14"	SS
25100	7" x 10"	PL
25101	10" x 14"	PL
42677	7" x 10"	AL
42678	10" x 14"	AL



69601	10" x 14"	FB
88402	7" x 10"	SS
88403	10" x 14"	SS
25102	7" x 10"	PL
25103	10" x 14"	PL
42679	7" x 10"	AL
42680	10" x 14"	AL

No Smoking Signs

BradyID.com/s36

No Smoking Signs (continued)



128174	7" x 10"	SS
128177	10" x 14"	SS
128173	7" x 10"	PL
128176	10" x 14"	PL
128172	7" x 10"	AL
128175	10" x 14"	AL



128186	7" x 10"	SS
128189	10" x 14"	SS
128185	7" x 10"	PL
128188	10" x 14"	PL
128184	7" x 10"	AL
128187	10" x 14"	AL



69600	10" x 14"	FB
88404	7" x 10"	SS
88405	10" x 14"	SS
25104	7" x 10"	PL
25105	10" x 14"	PL
42681	7" x 10"	AL
42682	10" x 14"	AL



128180	7" x 10"	SS
128183	10" x 14"	SS
128179	7" x 10"	PL
128182	10" x 14"	PL
128178	7" x 10"	AL
128181	10" x 14"	AL

Sign Selection Guide

- FB** - Premium fiberglass (B-120)
- SS** - Self-sticking polyester (B-302)
- PL** - Plastic (B-401)
- AL** - Aluminum (B-555)
- BGSS** - BradyGlo™ self-stick polyester (B-324)
- BGPL** - BradyGlo™ plastic (B-347)

Material Comparison page 408
Sign Legend Index..... page 588



69792	7" x 7"	FB
88520	7" x 7"	SS
25182	7" x 10"	PL
42759	7" x 10"	AL



88410	3.5" x 10"	SS
-------	------------	----



127976	7" x 10"	SS
127979	10" x 14"	SS
127975	7" x 10"	PL
127978	10" x 14"	PL
127974	7" x 10"	AL
127977	10" x 14"	AL



127970	7" x 10"	SS
127973	10" x 14"	SS
127969	7" x 10"	PL
127972	10" x 14"	PL
127968	7" x 10"	AL
127971	10" x 14"	AL



127982	7" x 10"	SS
127985	10" x 14"	SS
127981	7" x 10"	PL
127984	10" x 14"	PL
127980	7" x 10"	AL
127983	10" x 14"	AL



72255	14" x 20"	FB
88413	14" x 20"	SS
88414	10" x 14"	SS
25109	7" x 10"	PL
42686	7" x 10"	AL



87677	14" x 10"	FB
-------	-----------	----



72009	5" x 14"	FB
88421	3.5" x 10"	SS
88422	5" x 14"	SS
25114	7" x 10"	PL
42691	7" x 10"	AL



88423	7" x 10"	SS
88424	10" x 14"	SS
25115	7" x 10"	PL
25116	10" x 14"	PL
42692	7" x 10"	AL
42693	10" x 14"	AL



80248	7" x 10"	BGSS
80249	10" x 14"	BGSS
85482	7" x 10"	BGPL



72022	7" x 10"	FB
72024	10" x 14"	FB
89176	3.5" x 5"	SS
89154	5" x 14"	SS
88425	7" x 10"	SS
88426	10" x 14"	SS
25117	7" x 10"	PL
25118	10" x 14"	PL
42694	7" x 10"	AL
42695	10" x 14"	AL



72040	5" x 14"	FB
88418	5" x 14"	SS
25110	7" x 10"	PL
42687	7" x 10"	AL



141944	10" x 14"	FB
141949	14" x 20"	FB
141945	10" x 14"	SS
141950	14" x 20"	SS
141948	10" x 14"	PL
141953	14" x 20"	PL
141946	10" x 14"	AL
141951	14" x 20"	AL
141947	10" x 14"	SSV
141952	14" x 20"	SSV



Package includes 6 identical signs.



73487	10" x 14"	FB
88443	7" x 10"	SS
88444	10" x 14"	SS



72293	10" x 7"	FB
73486	14" x 10"	FB
72295	20" x 14"	FB
87795	3.5" x 5"	SS
88427	10" x 7"	SS
88428	14" x 10"	SS
25119	10" x 7"	PL
25120	14" x 10"	PL
42696	10" x 7"	AL
42697	14" x 10"	AL



72049	14" x 20"	FB
88429	7" x 10"	SS
88430	10" x 14"	SS
25121	7" x 10"	PL
42698	7" x 10"	AL



70450	14" x 20"	FB
88432	10" x 14"	SS
25122	7" x 10"	PL
42699	7" x 10"	AL

Safety Signs

No Smoking Signs (continued)



141939	10" x 7"	FB
141940	10" x 7"	PL
141943	10" x 7"	PL
141941	10" x 7"	AL
141942	10" x 7"	SSV



141919	10" x 14"	FB
141920	10" x 14"	PL
141923	10" x 14"	PL
141921	10" x 14"	AL
141922	10" x 14"	SSV



72055	5" x 14"	FB
88433	3.5" x 10"	SS
88434	5" x 14"	SS



25123	7" x 10"	PL
25884	10" x 14"	PL
42700	7" x 10"	AL
43461	10" x 14"	AL



88435	7" x 10"	SS
88436	10" x 14"	SS
25124	7" x 10"	PL
42701	7" x 10"	AL



141924	10" x 7"	FB
141925	10" x 7"	PL
141928	10" x 7"	PL
141926	10" x 7"	AL
141928	10" x 7"	SSV



46993	10" x 14"	FB
88437	7" x 10"	SS
88438	10" x 14"	SS
42702	7" x 10"	AL



128006	10" x 7"	SS
128009	14" x 10"	SS
128005	10" x 7"	PL
128008	14" x 10"	PL
128004	10" x 7"	AL
128007	14" x 10"	AL



72091	14" x 20"	FB
88439	7" x 10"	SS
88440	10" x 14"	SS
25126	7" x 10"	PL
42703	7" x 10"	AL



128000	10" x 7"	SS
128003	14" x 10"	SS
127999	10" x 7"	PL
128002	14" x 10"	PL
127998	10" x 7"	AL
128001	14" x 10"	AL



128036	7" x 10"	SS
128039	10" x 14"	SS
128035	7" x 10"	PL
128038	10" x 14"	PL
128034	7" x 10"	AL
128037	10" x 14"	AL



141964	10" x 14"	FB
141969	14" x 20"	FB
141965	10" x 14"	SS
141970	14" x 20"	SS
141968	10" x 14"	PL
141973	14" x 20"	PL
141966	10" x 14"	AL
141971	14" x 20"	AL
141967	10" x 14"	SSV
141972	14" x 20"	SSV



141954	10" x 14"	FB
141955	10" x 14"	SS
141957	10" x 14"	PL
141956	10" x 14"	AL
141958	10" x 14"	SSV



72097	14" x 20"	FB
88441	7" x 10"	SS
88442	10" x 14"	SS
25127	7" x 10"	PL
42704	7" x 10"	AL



47172	7" x 10"	FB
88445	7" x 10"	SS
88446	7" x 10"	SS
88447	10" x 14"	SS
25130	10" x 14"	PL
42706	7" x 10"	AL
42707	10" x 14"	AL



141959	10" x 7"	FB
141960	10" x 7"	PL
141963	10" x 7"	PL
141961	10" x 7"	AL
141962	10" x 7"	SSV



123893	10" x 7"	SS
123896	14" x 10"	SS
123892	10" x 7"	PL
123895	14" x 10"	PL
123891	10" x 7"	AL
123894	14" x 10"	AL



128012	10" x 7"	SS
128015	14" x 10"	SS
128011	10" x 7"	PL
128014	14" x 10"	PL
128010	10" x 7"	AL
128013	14" x 10"	AL



128024	7" x 10"	SS
128027	10" x 14"	SS
128023	7" x 10"	PL
128026	10" x 14"	PL
128022	7" x 10"	AL
128025	10" x 14"	AL



123941	10" x 7"	SS
123944	14" x 10"	SS
123940	10" x 7"	PL
123943	14" x 10"	PL
123939	10" x 7"	AL
123942	14" x 10"	AL



88448	5" x 14"	SS
-------	----------	----



25131	7" x 10"	PL
42708	7" x 10"	AL



128030	7" x 10"	SS
128033	10" x 14"	SS
128029	7" x 10"	PL
128032	10" x 14"	PL
128028	7" x 10"	AL
128031	10" x 14"	AL



122795	7" x 10"	FB
72148	10" x 14"	FB
88451	7" x 10"	SS
87797	3.5" x 5"	SS
88452	10" x 14"	SS
25134	7" x 10"	PL
25135	10" x 14"	PL
42711	7" x 10"	AL
42712	10" x 14"	AL

No Smoking Signs

BradyID.com/s36

No Smoking Signs (continued)



128042	7" x 10"	SS
128045	10" x 14"	SS
128041	7" x 10"	PL
128044	10" x 14"	PL
128040	7" x 10"	AL
128043	10" x 14"	AL



128018	10" x 7"	SS
128021	14" x 10"	SS
128017	10" x 7"	PL
128020	14" x 10"	PL
128016	10" x 7"	AL
128019	14" x 10"	AL



110977	10" x 7"	FB
110976	14" x 10"	FB
110978	10" x 7"	SS
110979	14" x 10"	SS
110975	10" x 7"	PL
110973	10" x 7"	AL
110972	14" x 10"	AL



122703	10" x 14"	FB
72155	14" x 20"	FB
88453	7" x 10"	SS
88454	7" x 10"	SS
25136	7" x 10"	PL
25137	10" x 14"	PL
42713	7" x 10"	AL
42714	10" x 14"	AL

Sign Selection Guide

- FB - Premium fiberglass (B-120)
- SS - Self-sticking polyester (B-302)
- PL - Plastic (B-401)
- AL - Aluminum (B-555)
- BGSS - BradyGlo™ self-stick polyester (B-324)
- BGPL - BradyGlo™ plastic (B-347)

Material Comparison page 408
Sign Legend Index..... page 588



123917	7" x 10"	SS
123920	10" x 14"	SS
123916	7" x 10"	PL
123919	10" x 14"	PL
123915	7" x 10"	AL
123918	10" x 14"	AL



128048	7" x 10"	SS
128051	10" x 14"	SS
128047	7" x 10"	PL
128050	10" x 14"	PL
128046	7" x 10"	AL
128049	10" x 14"	AL



124642	10" x 3.5"	SS
124641	10" x 3.5"	PL
124640	10" x 3.5"	AL



128054	10" x 7"	SS
128057	14" x 10"	SS
128053	10" x 7"	PL
128056	14" x 10"	PL
128052	10" x 7"	AL
128055	14" x 10"	AL



75972	7" x 10"	FB
75973	10" x 14"	FB
88457	7" x 10"	SS
88458	10" x 14"	SS
25139	7" x 10"	PL
25140	10" x 14"	PL
42716	7" x 10"	AL
42717	10" x 14"	AL



128072	7" x 10"	SS
128075	10" x 14"	SS
128071	7" x 10"	PL
128074	10" x 14"	PL
128070	7" x 10"	AL
128073	10" x 14"	AL



70730	10" x 14"	FB
-------	-----------	----



123049	7" x 5"	SS
123053	10" x 7"	SS
123050	7" x 5"	PL
123054	10" x 7"	PL
123051	7" x 5"	AL
123055	10" x 7"	AL
123048	7" x 5"	SSV
123052	10" x 7"	SSV



122796	7" x 10"	FB
72176	10" x 14"	FB
88467	7" x 10"	SS
88468	10" x 14"	SS
25144	7" x 10"	PL
122468	10" x 14"	PL
42721	7" x 10"	AL
122342	10" x 14"	AL



128060	10" x 7"	SS
128063	14" x 10"	SS
128059	10" x 7"	PL
128062	14" x 10"	PL
128058	10" x 7"	AL
128061	14" x 10"	AL



123899	10" x 7"	SS
123902	14" x 10"	SS
123898	10" x 7"	PL
123901	14" x 10"	PL
123897	10" x 7"	AL
123900	14" x 10"	AL



72296	10" x 7"	FB
72297	14" x 10"	FB
72298	20" x 14"	FB
88469	10" x 7"	SS
88470	14" x 10"	SS
25145	10" x 7"	PL
42722	10" x 7"	AL
42723	14" x 10"	AL



128078	7" x 10"	SS
128081	10" x 14"	SS
128077	7" x 10"	PL
128080	10" x 14"	PL
128076	7" x 10"	AL
128079	10" x 14"	AL



123905	10" x 7"	SS
123908	14" x 10"	SS
123904	10" x 7"	PL
123907	14" x 10"	PL
123903	10" x 7"	AL
123906	14" x 10"	AL



128084	7" x 10"	SS
128087	10" x 14"	SS
128083	7" x 10"	PL
128086	10" x 14"	PL
128082	7" x 10"	AL
128085	10" x 14"	AL



87691	10" x 14"	FB
87684	7" x 10"	SS
87685	10" x 14"	SS
87687	10" x 14"	PL
87688	7" x 10"	AL
87689	10" x 14"	AL



72341	10" x 14"	FB
72343	7" x 10"	SS
72344	10" x 14"	SS
72347	7" x 10"	PL
72348	10" x 14"	PL
72345	7" x 10"	AL
72346	10" x 14"	AL



141929	10" x 14"	FB
141934	14" x 20"	FB
141930	10" x 14"	SS
141935	14" x 20"	SS
141933	10" x 14"	PL
141938	14" x 20"	PL
141931	10" x 14"	AL
141936	14" x 20"	AL
141932	10" x 14"	SSV
141937	14" x 20"	SSV

Safety Signs

No Smoking Signs (continued)



128090	7" x 10"	SS
128093	10" x 14"	SS
128089	7" x 10"	PL
128092	10" x 14"	PL
128088	7" x 10"	AL
128091	10" x 14"	AL



123923	10" x 7"	SS
123926	14" x 10"	SS
123922	10" x 7"	PL
123925	14" x 10"	PL
123921	10" x 7"	AL
123924	14" x 10"	AL



123911	7" x 10"	SS
123914	10" x 14"	SS
123910	7" x 10"	PL
123913	10" x 14"	PL
123909	7" x 10"	AL
123912	10" x 14"	AL



123929	7" x 10"	SS
123932	10" x 14"	SS
123928	7" x 10"	PL
123931	10" x 14"	PL
123927	7" x 10"	AL
123930	10" x 14"	AL



72349	7" x 10"	FB
72355	7" x 10"	SS
72395	10" x 14"	SS
72398	7" x 10"	PL
72399	10" x 14"	PL
72396	7" x 10"	AL
72397	10" x 14"	AL



128096	7" x 10"	SS
128099	10" x 14"	SS
128095	7" x 10"	PL
128098	10" x 14"	PL
128094	7" x 10"	AL
128097	10" x 14"	AL



123935	10" x 7"	SS
123938	14" x 10"	SS
123934	10" x 7"	PL
123937	14" x 10"	PL
123933	10" x 7"	AL
123936	14" x 10"	AL



128114	10" x 7"	SS
128117	14" x 10"	SS
128113	10" x 7"	PL
128116	14" x 10"	PL
128112	10" x 7"	AL
128115	14" x 10"	AL

Design custom smoking area signs online

BradyID.com/customsigns

Designated Smoking Areas



132011	7" x 10"	FB
132012	10" x 14"	FB
132009	7" x 10"	SS
132010	10" x 14"	SS
132007	7" x 10"	PL
132008	10" x 14"	PL
132005	7" x 10"	AL
132006	10" x 14"	AL



72328	7" x 10"	FB
72329	10" x 14"	FB
88392	7" x 10"	SS
88393	10" x 14"	SS
25094	7" x 10"	PL
25095	10" x 14"	PL
42671	7" x 10"	AL
42672	10" x 14"	AL



143465	7" x 10"	SS
143466	10" x 14"	SS
143463	7" x 10"	PL
143464	10" x 14"	PL
143461	7" x 10"	AL
143462	10" x 14"	AL



46872	3.5" x 10"	AL
-------	------------	----



122906	7" x 10"	FB
46990	10" x 14"	FB
88411	7" x 10"	SS
88412	10" x 14"	SS
25108	7" x 10"	PL
122496	10" x 14"	PL
42685	7" x 10"	AL
122384	10" x 14"	AL



103845	10" x 14"	PL
--------	-----------	----



103844	10" x 14"	PL
--------	-----------	----



127994	10" x 7"	SS
127997	14" x 10"	SS
127993	10" x 7"	PL
127996	14" x 10"	PL
127992	10" x 7"	AL
127995	14" x 10"	AL



127988	7" x 10"	SS
127991	10" x 14"	SS
127987	7" x 10"	PL
127990	10" x 14"	PL
127986	7" x 10"	AL
127989	10" x 14"	AL



128066	10" x 7"	SS
128069	14" x 10"	SS
128065	10" x 7"	PL
128068	14" x 10"	PL
128064	10" x 7"	AL
128067	14" x 10"	AL



122797	7" x 10"	FB
72336	10" x 14"	FB
88471	7" x 10"	SS
88472	10" x 14"	SS
25147	7" x 10"	PL
25148	10" x 14"	PL
42724	7" x 10"	AL
42725	10" x 14"	AL

Personal Hygiene Signs

BradyID.com/s36

Personal Hygiene Signs

Brady personal hygiene signs remind and encourage employees to use appropriate sanitary methods such as hand washing and use of hair nets before returning to work.

Sign Selection Guide

FB - Premium fiberglass (B-120)
SS - Self-sticking polyester (B-302)
PL - Plastic (B-401)
AL - Aluminum (B-555)
BGSS - BradyGlo™ self-stick polyester (B-324)
BGPL - BradyGlo™ plastic (B-347)

Material Comparison page 408
 Sign Legend Index..... page 588



30705 10" x 14" SS
 30707 10" x 14" PL



47579 10" x 14" PL



128456 10" x 7" SS
 128459 14" x 10" SS
 128455 10" x 7" PL
 128458 14" x 10" PL
 128454 10" x 7" AL
 128457 14" x 10" AL



122789 7" x 10" FB
 73474 10" x 14" FB
 88475 7" x 10" SS
 88476 10" x 14" SS
 25149 7" x 10" PL
 25150 10" x 14" PL
 42726 7" x 10" AL
 42727 10" x 14" AL



72988 14" x 20" FB
 88477 7" x 10" SS
 88478 10" x 14" SS
 25151 7" x 10" PL
 25152 10" x 14" PL
 42728 7" x 10" AL
 42729 10" x 14" AL



88479 7" x 10" SS
 88480 10" x 14" SS
 25153 7" x 10" PL
 25154 10" x 14" PL
 42730 7" x 10" AL
 42731 10" x 14" AL



69567 10" x 14" FB
 88485 7" x 10" SS
 88486 10" x 14" SS
 25155 7" x 10" PL
 25156 10" x 14" PL
 42732 7" x 10" AL
 42733 10" x 14" AL



128450 10" x 7" SS
 128453 14" x 10" SS
 128449 10" x 7" PL
 128452 14" x 10" PL
 128448 10" x 7" AL
 128451 14" x 10" AL



87732 10" x 14" FB
 30911 10" x 14" SS
 30913 10" x 14" PL
 30914 10" x 14" AL



47636 10" x 7" SS
 47638 10" x 7" PL
 47639 10" x 7" AL



47587 10" x 14" SS
 57079 10" x 14" AL



47593 10" x 14" SS
 47595 10" x 14" PL



47606 10" x 14" SS
 47612 10" x 14" PL



128312 10" x 7" SS
 128315 14" x 10" SS
 128311 10" x 7" PL
 128314 14" x 10" PL
 128310 10" x 7" AL
 128313 14" x 10" AL



128330 7" x 10" SS
 128333 10" x 14" SS
 128329 7" x 10" PL
 128332 10" x 14" PL
 128328 7" x 10" AL
 128331 10" x 14" AL



87738 10" x 14" FB
 57084 10" x 14" SS
 47632 10" x 14" PL



31218 10" x 14" PL
 31219 10" x 14" AL



88682 7" x 10" SS
 88683 10" x 14" SS
 25250 7" x 10" PL
 25251 10" x 14" PL
 42828 10" x 14" AL



128384 7" x 10" SS
 128387 10" x 14" SS
 128383 7" x 10" PL
 128386 10" x 14" PL
 128382 7" x 10" AL
 128385 10" x 14" AL



47649 10" x 7" SS
 47651 10" x 7" PL
 47652 10" x 7" AL

Safety Signs

Personal Protection Signs

Brady's full line of personal protection signs remind employees and floor workers about areas that require a hardhat, ear protection, face shield, eye protection or other garment. Brady personal protection signs are a strong and noticeable reminder for your employees to maintain a safe work atmosphere.



22575	7" x 10"	PL
22576	10" x 14"	PL



129032	7" x 10"	SS
129035	10" x 14"	SS
129031	7" x 10"	PL
129034	10" x 14"	PL
129030	7" x 10"	AL
129033	10" x 14"	AL



124225	10" x 7"	SS
124228	14" x 10"	SS
124224	10" x 7"	PL
124227	14" x 10"	PL
124223	10" x 7"	AL
124226	14" x 10"	AL



129038	7" x 10"	SS
129041	10" x 14"	SS
129037	7" x 10"	PL
129040	10" x 14"	PL
129036	7" x 10"	AL
129039	10" x 14"	AL



131949	7" x 10"	FB
131950	10" x 14"	FB
131947	7" x 10"	SS
131948	10" x 14"	SS
131945	7" x 10"	PL
131946	10" x 14"	PL
131943	7" x 10"	AL
131944	10" x 14"	AL



128516	7" x 10"	SS
128519	10" x 14"	SS
128515	7" x 10"	PL
128518	10" x 14"	PL
128514	7" x 10"	AL
128517	10" x 14"	AL



69041	10" x 14"	FB
84971	7" x 10"	SS
84972	10" x 14"	SS
22577	7" x 10"	PL
22578	10" x 14"	PL
41141	7" x 10"	AL
41142	10" x 14"	AL



131941	7" x 10"	FB
131942	10" x 14"	FB
131939	7" x 10"	SS
131940	10" x 14"	SS
131937	7" x 10"	PL
131938	10" x 14"	PL
131935	7" x 10"	AL
131936	10" x 14"	AL



47056	7" x 10"	FB
47094	10" x 14"	FB
84973	7" x 10"	SS
22579	7" x 10"	PL
22580	10" x 14"	PL
41143	7" x 10"	AL



47059	7" x 10"	FB
84975	7" x 10"	SS
84976	10" x 14"	SS
22581	7" x 10"	PL
25773	10" x 14"	PL
41145	7" x 10"	AL
43350	10" x 14"	AL



70286	10" x 14"	FB
85079	7" x 10"	SS
85080	10" x 14"	SS
25594	7" x 10"	PL
25595	10" x 14"	PL
43171	7" x 10"	AL
43172	10" x 14"	AL



74542	20" x 14"	FB
84977	10" x 7"	SS
22582	10" x 7"	PL
22583	14" x 10"	PL
41146	10" x 7"	AL



70288	7" x 10"	FB
25192	7" x 10"	PL
25193	10" x 14"	PL
42769	7" x 10"	AL



105728	10" x 7"	FB
105729	14" x 10"	FB
105730	20" x 14"	FB
105734	14" x 10"	AL



128522	7" x 10"	SS
128525	10" x 14"	SS
128521	7" x 10"	PL
128524	10" x 14"	PL
128520	7" x 10"	AL
128523	10" x 14"	AL



88543	7" x 10"	SS
88544	10" x 14"	SS
25194	7" x 10"	PL
25195	10" x 14"	PL
42771	7" x 10"	AL
42772	10" x 14"	AL



84774	7" x 10"	SS
84775	10" x 14"	SS
25454	7" x 10"	PL
43032	10" x 14"	AL



128528	7" x 10"	SS
128531	10" x 14"	SS
128527	7" x 10"	PL
128530	10" x 14"	PL
128526	7" x 10"	AL
128529	10" x 14"	AL



70299	20" x 14"	FB
84776	10" x 7"	SS
84777	14" x 10"	SS
25456	10" x 7"	PL
25457	14" x 10"	PL
43033	10" x 7"	AL
43034	14" x 10"	AL



84778	7" x 10"	SS
84779	10" x 14"	SS
25459	10" x 14"	PL
43035	7" x 10"	AL
43036	10" x 14"	AL

Regulations

Safety Instruction Signs

1910.145(c)(3)

Safety instruction signs shall be used where there is a need for general instructions and suggestions relative to safety measures.

Danger Signs

1910.145(c)(1)(ii)

All employees shall be instructed that danger signs indicate immediate danger and that special precautions are necessary.

Caution Signs

1910.145(c)(2)(i)

Caution signs shall be used only to warn against potential hazards or to caution against unsafe practices.

1910.145(c)(2)(ii)

All employees shall be instructed that caution signs indicate a possible hazard against which proper precaution should be taken.

Personal Protection Signs

BradyID.com/s36

Personal Protection Signs (continued)



25891 10' x 14' PL
43468 10' x 14' AL



70303 7' x 17' FB



70305 10' x 14' FB
84780 7' x 10' SS
25460 7' x 10' PL
25461 10' x 14' PL
43037 7' x 10' AL
43038 10' x 14' AL



70302 10' x 14' FB
84782 7' x 10' SS
84783 10' x 14' SS
25462 7' x 10' PL
25463 10' x 14' PL
43039 7' x 10' AL
43040 10' x 14' AL

Sign Selection Guide

- FB - Premium fiberglass (B-120)
- SS - Self-sticking polyester (B-302)
- PL - Plastic (B-401)
- AL - Aluminum (B-555)
- BGSS - BradyGlo™ self-stick polyester (B-324)
- BGPL - BradyGlo™ plastic (B-347)

Material Comparison page 408
Sign Legend Index..... page 588



69226 10' x 14' FB
88545 7' x 10' SS
88546 10' x 14' SS
25196 7' x 10' PL
25197 10' x 14' PL
42773 7' x 10' AL
42774 10' x 14' AL



76070 10' x 14' FB
88547 7' x 10' SS
88548 10' x 14' SS
25198 7' x 10' PL
25199 10' x 14' PL
42775 7' x 10' AL
42776 10' x 14' AL



69229 10' x 14' FB
88551 7' x 10' SS
88552 10' x 14' SS
25200 7' x 10' PL
25201 10' x 14' PL
42777 7' x 10' AL
42778 10' x 14' AL



70335 7' x 17' FB



47061 7' x 10' FB
47050 10' x 14' FB
87769 3.5' x 5' SS
84529 7' x 10' SS
84530 10' x 14' SS
22399 7' x 10' PL
22400 10' x 14' PL
40964 10' x 14' AL



122900 7' x 10' FB
122762 10' x 14' FB
122692 7' x 10' SS
122616 10' x 14' SS
122557 7' x 10' PL
25892 10' x 14' PL
122449 7' x 10' AL
43469 10' x 14' AL



73457 7' x 17' FB



47100 10' x 14' FB
84981 7' x 10' SS
84982 10' x 14' SS
22584 7' x 10' PL
22585 10' x 14' PL
41148 7' x 10' AL
41149 10' x 14' AL



84531 7' x 10' SS
84532 10' x 14' SS
22402 10' x 14' PL
40965 7' x 10' AL
40966 10' x 14' AL



122839 7' x 10' FB
70339 10' x 14' FB
84983 7' x 10' SS
84984 10' x 14' SS
22586 7' x 10' PL
22587 10' x 14' PL
41150 7' x 10' AL
41151 10' x 14' AL



128534 7' x 10' SS
128537 10' x 14' SS
128533 7' x 10' PL
128536 10' x 14' PL
128532 7' x 10' AL
128535 10' x 14' AL



124261 7' x 10' SS
124264 10' x 14' SS
124260 7' x 10' PL
124263 10' x 14' PL
124259 7' x 10' AL
124262 10' x 14' AL



129044 7' x 10' SS
129047 10' x 14' SS
129043 7' x 10' PL
129046 10' x 14' PL
129042 7' x 10' AL
129045 10' x 14' AL



129050 7' x 10' SS
129053 10' x 14' SS
129049 7' x 10' PL
129052 10' x 14' PL
129048 7' x 10' AL
129051 10' x 14' AL



65039 10' x 14' FB
89091 7' x 10' SS
89090 10' x 14' SS
25416 7' x 10' PL
25417 10' x 14' PL
42993 7' x 10' AL
42994 10' x 14' AL



70352 7' x 17' FB



128618 10' x 7' SS
128621 14' x 10' SS
128617 10' x 7' PL
128620 14' x 10' PL
128616 10' x 7' AL
128619 14' x 10' AL



122841 7' x 10' FB
70358 10' x 14' FB
87770 3.5' x 5' SS
84533 7' x 10' SS
84534 10' x 14' SS
22403 7' x 10' PL
22404 10' x 14' PL
40967 7' x 10' AL
40968 10' x 14' AL



131933 7' x 10' FB
131934 10' x 14' FB
131931 7' x 10' SS
131932 10' x 14' SS
131929 7' x 10' PL
131930 10' x 14' PL
131927 7' x 10' AL
131928 10' x 14' AL



124294 7' x 10' SS
124297 10' x 14' SS
124293 7' x 10' PL
124296 10' x 14' PL
124292 7' x 10' AL
124295 10' x 14' AL



128540 7' x 10' SS
128543 10' x 14' SS
128539 7' x 10' PL
128542 10' x 14' PL
128538 7' x 10' AL
128541 10' x 14' AL



70359 7' x 17' FB

Safety Signs

Personal Protection Signs

BradyID.com/s36

Personal Protection Signs (continued)



122833	7" x 10"	FB
74581	10" x 14"	FB
87771	3.5" x 5"	SS
84535	7" x 10"	SS
84536	10" x 14"	SS
122520	7" x 10"	PL
22406	10" x 14"	PL
122408	7" x 10"	AL
40970	10" x 14"	AL



131925	7" x 10"	FB
131926	10" x 14"	FB
131923	7" x 10"	SS
131924	10" x 14"	SS
131922	7" x 10"	PL
25893	10" x 14"	PL
131921	7" x 10"	AL
43470	10" x 14"	AL



124249	7" x 10"	SS
124252	10" x 14"	SS
124248	7" x 10"	PL
124251	10" x 14"	PL
124247	7" x 10"	AL
124250	10" x 14"	AL



128552	7" x 10"	SS
128555	10" x 14"	SS
128551	7" x 10"	PL
128554	10" x 14"	PL
128550	7" x 10"	AL
128553	10" x 14"	AL



128546	7" x 10"	SS
128549	10" x 14"	SS
128545	7" x 10"	PL
128548	10" x 14"	PL
128544	7" x 10"	AL
128547	10" x 14"	AL



122834	7" x 10"	FB
47101	10" x 14"	FB
75900	14" x 20"	FB
87778	3.5" x 5"	SS
84784	7" x 10"	SS
84785	10" x 14"	SS
25464	7" x 10"	PL
25465	10" x 14"	PL
43041	7" x 10"	AL
43042	10" x 14"	AL



47064	7" x 10"	FB
47018	10" x 14"	FB
75914	14" x 20"	FB
87772	3.5" x 5"	SS
84537	7" x 10"	SS
84538	10" x 14"	SS
22407	7" x 10"	PL
22408	10" x 14"	PL
40971	7" x 10"	AL
40972	10" x 14"	AL



131913	7" x 10"	FB
131914	10" x 14"	FB
131911	7" x 10"	SS
131912	10" x 14"	SS
131910	7" x 10"	PL
25894	10" x 14"	PL
131909	7" x 10"	AL
43471	10" x 14"	AL



84788	7" x 10"	SS
84789	10" x 14"	SS
25466	7" x 10"	PL
25467	10" x 14"	PL
43043	7" x 10"	AL
43044	10" x 14"	AL



87664	10" x 14"	FB
33656	10" x 14"	SS
33658	10" x 14"	PL
33659	10" x 14"	AL



75919	7" x 10"	FB
84790	7" x 10"	SS
84791	10" x 14"	SS
25468	7" x 10"	PL
25469	10" x 14"	PL
43045	7" x 10"	AL
43046	10" x 14"	AL



128558	7" x 10"	SS
128561	10" x 14"	SS
128557	7" x 10"	PL
128560	10" x 14"	PL
128556	7" x 10"	AL
128559	10" x 14"	AL



128570	7" x 10"	SS
128573	10" x 14"	SS
128569	7" x 10"	PL
128572	10" x 14"	PL
128568	7" x 10"	AL
128571	10" x 14"	AL



129170	7" x 10"	SS
129173	10" x 14"	SS
129169	7" x 10"	PL
129172	10" x 14"	PL
129168	7" x 10"	AL
129171	10" x 14"	AL



84792	10" x 7"	SS
84793	14" x 10"	SS
25470	10" x 7"	PL
25471	14" x 10"	PL
43047	10" x 7"	AL
43048	14" x 10"	AL



128564	7" x 10"	SS
128567	10" x 14"	SS
128563	7" x 10"	PL
128566	10" x 14"	PL
128562	7" x 10"	AL
128565	10" x 14"	AL



70383	10" x 14"	FB
84794	7" x 10"	SS
84795	10" x 14"	SS
25472	7" x 10"	PL
25473	10" x 14"	PL
43049	7" x 10"	AL
43050	10" x 14"	AL



73461	10" x 14"	FB
84796	7" x 10"	SS
84797	10" x 14"	SS
25474	7" x 10"	PL
25475	10" x 14"	PL
43051	7" x 10"	AL
43052	10" x 14"	AL



69331	10" x 14"	FB
84987	7" x 10"	SS
22588	7" x 10"	PL
22589	10" x 14"	PL
41152	7" x 10"	AL
41153	10" x 14"	AL



128576	7" x 10"	SS
128579	10" x 14"	SS
128575	7" x 10"	PL
128578	10" x 14"	PL
128574	7" x 10"	AL
128577	10" x 14"	AL



128582	7" x 10"	SS
128585	10" x 14"	SS
128581	7" x 10"	PL
128584	10" x 14"	PL
128580	7" x 10"	AL
128583	10" x 14"	AL

Personal Protection Signs

BradyID.com/s36

Personal Protection Signs (continued)



70475	10' x 14'	FB
88571	7' x 10'	SS
88572	10' x 14'	SS
25204	7' x 10'	PL
25205	10' x 14'	PL
42781	7' x 10'	AL
42782	10' x 14'	AL



131966	10' x 14'	FB
131965	10' x 14'	SS
131964	10' x 14'	PL
131963	10' x 14'	AL



131974	10' x 14'	FB
131973	10' x 14'	SS
131972	10' x 14'	PL
131971	10' x 14'	AL



131986	10' x 14'	FB
131985	10' x 14'	SS
131984	10' x 14'	PL
131983	10' x 14'	AL

Sign Selection Guide

- FB - Premium fiberglass (B-120)
- SS - Self-sticking polyester (B-302)
- PL - Plastic (B-401)
- AL - Aluminum (B-555)
- BGSS - BradyGlo™ self-stick polyester (B-324)
- BGPL - BradyGlo™ plastic (B-347)

Material Comparison page 408
Sign Legend Index..... page 588



131982	10' x 14'	FB
131981	10' x 14'	SS
131980	10' x 14'	PL
131979	10' x 14'	AL



131970	10' x 14'	FB
131969	10' x 14'	SS
131968	10' x 14'	PL
131967	10' x 14'	AL



131962	10' x 14'	FB
131961	10' x 14'	SS
131960	10' x 14'	PL
131959	10' x 14'	AL



131978	10' x 14'	FB
131977	10' x 14'	SS
131976	10' x 14'	PL
131975	10' x 14'	AL



122846	7' x 10'	FB
73470	10' x 14'	FB
84545	7' x 10'	SS
84546	10' x 14'	SS
22415	7' x 10'	PL
22416	10' x 14'	PL
122410	7' x 10'	AL
40980	10' x 14'	AL



65916	14' x 10'	FB
65917	20' x 14'	FB
84547	14' x 10'	SS
22417	14' x 10'	PL
40981	14' x 10'	AL



131957	7' x 10'	FB
131958	10' x 14'	FB
131955	7' x 10'	SS
131956	10' x 14'	SS
131953	7' x 10'	PL
131954	10' x 14'	PL
131951	7' x 10'	AL
131952	10' x 14'	AL



128588	7' x 10'	SS
128591	10' x 14'	SS
128587	7' x 10'	PL
128590	10' x 14'	PL
128586	7' x 10'	AL
128589	10' x 14'	AL



122847	7' x 10'	FB
70506	10' x 14'	FB
84556	7' x 10'	SS
84557	10' x 14'	SS
22418	7' x 10'	PL
22419	10' x 14'	PL
40982	7' x 10'	AL
40983	10' x 14'	AL



75042	14' x 20'	FB
84989	7' x 10'	SS
84990	10' x 14'	SS
22590	7' x 10'	PL
22591	10' x 14'	PL
41154	7' x 10'	AL
41155	10' x 14'	AL



74630	14' x 20'	FB
84991	7' x 10'	SS
84992	10' x 14'	SS
22592	7' x 10'	PL
22593	10' x 14'	PL
41156	7' x 10'	AL
41157	10' x 14'	AL



84993	7' x 10'	SS
84994	10' x 14'	SS
22594	7' x 10'	PL
22595	10' x 14'	PL
41158	7' x 10'	AL
41159	10' x 14'	AL

Safety Signs

Create Your Own PPE Sign

Adhere PPE pictos onto these blank signs to create the unique PPE combination that your application requires.



131990	10' x 14'	FB
131989	10' x 14'	SS
131988	10' x 14'	PL
131987	10' x 14'	AL



131997	10' x 7'	FB
131998	14' x 10'	FB
131995	10' x 7'	SS
131996	14' x 10'	SS
131993	10' x 7'	PL
131994	14' x 10'	PL
131991	10' x 7'	AL
131992	14' x 10'	AL



84548 2.25' x 2.25' SS



84549 2.25' x 2.25' SS



84550 2.25' x 2.25' SS



84551 2.25' x 2.25' SS



84552 2.25' x 2.25' SS



84553 2.25' x 2.25' SS



84554 2.25' x 2.25' SS



84555 2.25' x 2.25' SS

Personal Protection Signs

BradyID.com/s36

Personal Protection Signs (continued)



128594	7" x 10"	SS
128597	10" x 14"	SS
128593	7" x 10"	PL
128596	10" x 14"	PL
128592	7" x 10"	AL
128595	10" x 14"	AL



75976	7" x 10"	FB
75977	10" x 14"	FB
84995	7" x 10"	SS
84996	10" x 14"	SS
22596	7" x 10"	PL
22597	10" x 14"	PL
41160	7" x 10"	AL
41161	10" x 14"	AL



131919	7" x 10"	FB
131920	10" x 14"	FB
131917	7" x 10"	SS
131918	10" x 14"	SS
131916	7" x 10"	PL
25895	10" x 14"	PL
131915	7" x 10"	AL



25895	10" x 14"	PL
43472	10" x 14"	AL



128600	7" x 10"	SS
128603	10" x 14"	SS
128599	7" x 10"	PL
128602	10" x 14"	PL
128598	7" x 10"	AL
128601	10" x 14"	AL



122767	10" x 14"	FB
122455	7" x 10"	AL
122383	10" x 14"	AL



128606	7" x 10"	SS
128609	10" x 14"	SS
128605	7" x 10"	PL
128608	10" x 14"	PL
128604	7" x 10"	AL
128607	10" x 14"	AL



128612	7" x 10"	SS
128615	10" x 14"	SS
128611	7" x 10"	PL
128614	10" x 14"	PL
128610	7" x 10"	AL
128613	10" x 14"	AL



122836	7" x 10"	FB
--------	----------	----



128660	7" x 10"	SS
128663	10" x 14"	SS
128659	7" x 10"	PL
128662	10" x 14"	PL
128658	7" x 10"	AL
128661	10" x 14"	AL



128666	7" x 10"	SS
128669	10" x 14"	SS
128665	7" x 10"	PL
128668	10" x 14"	PL
128664	7" x 10"	AL
128667	10" x 14"	AL



84798	7" x 10"	SS
84799	10" x 14"	SS
25476	7" x 10"	PL
25477	10" x 14"	PL
43053	7" x 10"	AL
43054	10" x 14"	AL



25908	10" x 14"	PL
43485	10" x 14"	AL



84997	7" x 10"	SS
84998	10" x 14"	SS
22599	10" x 14"	PL
41162	7" x 10"	AL
41163	10" x 14"	AL



25909	10" x 14"	PL
43486	10" x 14"	AL



128648	7" x 10"	SS
128651	10" x 14"	SS
128647	7" x 10"	PL
128650	10" x 14"	PL
128646	7" x 10"	AL
128649	10" x 14"	AL



128636	7" x 10"	SS
128639	10" x 14"	SS
128635	7" x 10"	PL
128638	10" x 14"	PL
128634	7" x 10"	AL
128637	10" x 14"	AL



84999	7" x 10"	SS
85000	10" x 14"	SS
22600	7" x 10"	PL
22601	10" x 14"	PL
41164	7" x 10"	AL
41165	10" x 14"	AL



85001	7" x 10"	SS
85002	10" x 14"	SS
22602	7" x 10"	PL
22603	10" x 14"	PL
41166	7" x 10"	AL
41167	10" x 14"	AL



128630	7" x 10"	SS
128633	10" x 14"	SS
128629	7" x 10"	PL
128632	10" x 14"	PL
128628	7" x 10"	AL
128631	10" x 14"	AL



124255	10" x 7"	SS
124258	14" x 10"	SS
124254	10" x 7"	PL
124257	14" x 10"	PL
124253	10" x 7"	AL
124256	14" x 10"	AL



128654	7" x 10"	SS
128657	10" x 14"	SS
128653	7" x 10"	PL
128656	10" x 14"	PL
128652	7" x 10"	AL
128655	10" x 14"	AL



128642	7" x 10"	SS
128645	10" x 14"	SS
128641	7" x 10"	PL
128644	10" x 14"	PL
128640	7" x 10"	AL
128643	10" x 14"	AL



122837	7" x 10"	FB
74740	10" x 14"	FB
88583	7" x 10"	SS
88584	10" x 14"	SS
25206	7" x 10"	PL
25207	10" x 14"	PL
42783	7" x 10"	AL
42784	10" x 14"	AL



128672	7" x 10"	SS
128675	10" x 14"	SS
128671	7" x 10"	PL
128674	10" x 14"	PL
128670	7" x 10"	AL
128673	10" x 14"	AL



74764	10" x 14"	FB
88585	7" x 10"	SS
88586	10" x 14"	SS
25208	7" x 10"	PL
25209	10" x 14"	PL
42785	7" x 10"	AL



Safety Signs

Personal Protection Signs

BradyID.com/s36

Personal Protection Signs (continued)



129098	7" x 10"	SS
129101	10" x 14"	SS
129097	7" x 10"	PL
129100	10" x 14"	PL
129096	7" x 10"	AL
129099	10" x 14"	AL



40651	7" x 10"	AL
40652	10" x 14"	AL



128702	7" x 10"	SS
128705	10" x 14"	SS
128701	7" x 10"	PL
128704	10" x 14"	PL
128700	7" x 10"	AL
128703	10" x 14"	AL



70273	10" x 14"	FB
85003	7" x 10"	SS
22605	10" x 14"	PL

Sign Selection Guide

- FB** - Premium fiberglass (B-120)
- SS** - Self-sticking polyester (B-302)
- PL** - Plastic (B-401)
- AL** - Aluminum (B-555)
- BGSS** - BradyGlo™ self-stick polyester (B-324)
- BGPL** - BradyGlo™ plastic (B-347)

Material Comparison page 408
Sign Legend Index..... page 588



128720	7" x 10"	SS
128723	10" x 14"	SS
128719	7" x 10"	PL
128722	10" x 14"	PL
128718	7" x 10"	AL
128721	10" x 14"	AL



85007	7" x 10"	SS
85008	10" x 14"	SS
22606	7" x 10"	PL
22607	10" x 14"	PL
41170	7" x 10"	AL
41171	10" x 14"	AL



128714	7" x 10"	SS
128717	10" x 14"	SS
128713	7" x 10"	PL
128716	10" x 14"	PL
128712	7" x 10"	AL
128715	10" x 14"	AL



128708	7" x 10"	SS
128711	10" x 14"	SS
128707	7" x 10"	PL
128710	10" x 14"	PL
128706	7" x 10"	AL
128709	10" x 14"	AL



70287	20" x 14"	FB
85011	7" x 10"	SS
22608	10" x 7"	PL
22609	14" x 10"	PL
41172	10" x 7"	AL
41173	14" x 10"	AL



70298	7" x 17"	FB
-------	----------	----



69184	10" x 14"	FB
84802	7" x 10"	SS
84803	10" x 14"	SS
25478	7" x 10"	PL
25479	10" x 14"	PL
43055	7" x 10"	AL
43056	10" x 14"	AL



25896	10" x 14"	PL
43473	10" x 14"	AL



84804	7" x 10"	SS
84805	10" x 14"	SS
25480	7" x 10"	PL
43057	7" x 10"	AL
43058	10" x 14"	AL



73456	10" x 14"	FB
84806	7" x 10"	SS
84807	10" x 14"	SS
25482	7" x 10"	PL
43059	7" x 10"	AL
43060	10" x 14"	AL



85015	7" x 10"	SS
85016	10" x 14"	SS
22612	7" x 10"	PL
22613	10" x 14"	PL
41176	7" x 10"	AL
41177	10" x 14"	AL



128732	7" x 10"	SS
128735	10" x 14"	SS
128731	7" x 10"	PL
128734	10" x 14"	PL
128730	7" x 10"	AL
128733	10" x 14"	AL



128726	7" x 10"	SS
128729	10" x 14"	SS
128725	7" x 10"	PL
128728	10" x 14"	PL
128724	7" x 10"	AL
128727	10" x 14"	AL



128738	7" x 10"	SS
128741	10" x 14"	SS
128737	7" x 10"	PL
128740	10" x 14"	PL
128736	7" x 10"	AL
128739	10" x 14"	AL



128696	7" x 10"	SS
128699	10" x 14"	SS
128695	7" x 10"	PL
128698	10" x 14"	PL
128694	7" x 10"	AL
128697	10" x 14"	AL



129104	7" x 10"	SS
129107	10" x 14"	SS
129103	7" x 10"	PL
129106	10" x 14"	PL
129102	7" x 10"	AL
129105	10" x 14"	AL



47158	7" x 10"	FB
47189	10" x 14"	FB
88611	7" x 10"	SS
88612	10" x 14"	SS
25216	7" x 10"	PL
25217	10" x 14"	PL
42793	7" x 10"	AL
42794	10" x 14"	AL



128744	7" x 10"	SS
128747	10" x 14"	SS
128743	7" x 10"	PL
128746	10" x 14"	PL
128742	7" x 10"	AL
128745	10" x 14"	AL

Safety Signs

Personal Protection Signs

BradyID.com/s36

Personal Protection Signs (continued)



75979	7" x 10"	FB
75980	10" x 14"	FB
42791	7" x 10"	AL
42792	10" x 14"	AL
25214	7" x 10"	PL
25215	10" x 14"	PL
88609	7" x 10"	SS
88610	10" x 14"	SS



128750	7" x 10"	SS
128753	10" x 14"	SS
128749	7" x 10"	PL
128752	10" x 14"	PL
128748	7" x 10"	AL
128751	10" x 14"	AL



123679	7" x 10"	SS
123682	10" x 14"	SS
123678	7" x 10"	PL
123681	10" x 14"	PL
123677	7" x 10"	AL
123680	10" x 14"	AL



128756	7" x 10"	SS
128759	10" x 14"	SS
128755	7" x 10"	PL
128758	10" x 14"	PL
128754	7" x 10"	AL
128757	10" x 14"	AL



128762	7" x 10"	SS
128765	10" x 14"	SS
128761	7" x 10"	PL
128764	10" x 14"	PL
128760	7" x 10"	AL
128763	10" x 14"	AL



128768	7" x 10"	SS
128771	10" x 14"	SS
128767	7" x 10"	PL
128770	10" x 14"	PL
128766	7" x 10"	AL
128769	10" x 14"	AL



128774	7" x 10"	SS
128777	10" x 14"	SS
128773	7" x 10"	PL
128776	10" x 14"	PL
128772	7" x 10"	AL
128775	10" x 14"	AL



69469	10" x 14"	FB
88617	7" x 10"	SS
88618	10" x 14"	SS
25218	7" x 10"	PL
25219	10" x 14"	PL
42795	7" x 10"	AL
42796	10" x 14"	AL



69472	10" x 14"	FB
88619	7" x 10"	SS
88620	10" x 14"	SS
25220	7" x 10"	PL
25221	10" x 14"	PL
42797	7" x 10"	AL
42798	10" x 14"	AL



128780	7" x 10"	SS
128783	10" x 14"	SS
128779	7" x 10"	PL
128782	10" x 14"	PL
128778	7" x 10"	AL
128781	10" x 14"	AL



128786	7" x 10"	SS
128789	10" x 14"	SS
128785	7" x 10"	PL
128788	10" x 14"	PL
128784	7" x 10"	AL
128787	10" x 14"	AL



70515	10" x 14"	FB
87780	3.5' x 5'	SS
85017	7" x 10"	SS
85018	10" x 14"	SS
22614	7" x 10"	PL
22615	10" x 14"	PL
41178	7" x 10"	AL



70517	7" x 17"	FB
-------	----------	----



69486	7" x 17"	FB
-------	----------	----



85021	7" x 10"	SS
23049	7" x 10"	PL
22619	10" x 14"	PL



128798	7" x 10"	SS
128801	10" x 14"	SS
128797	7" x 10"	PL
128800	10" x 14"	PL
128796	7" x 10"	AL
128799	10" x 14"	AL



70588	10" x 14"	FB
85027	7" x 10"	SS
85028	10" x 14"	SS
22620	7" x 10"	PL
22621	10" x 14"	PL
41184	7" x 10"	AL



128804	7" x 10"	SS
128807	10" x 14"	SS
128803	7" x 10"	PL
128806	10" x 14"	PL
128802	7" x 10"	AL
128805	10" x 14"	AL



Safety Signs

Personal Protection Signs

BradyID.com/s36

Personal Protection Signs (continued)

NOTICE
ALL EMPLOYEES AND VISITORS MUST WEAR EYE PROTECTION

128810	7" x 10"	SS
128813	10" x 14"	SS
128809	7" x 10"	PL
128812	10" x 14"	PL
128808	7" x 10"	AL
128811	10" x 14"	AL

NOTICE
ALL PERSONNEL MUST WEAR SAFETY GLASSES IN THE PLANT

74948	14" x 20"	FB
85029	7" x 10"	SS
85030	10" x 14"	SS
22622	7" x 10"	PL
22623	10" x 14"	PL
41186	7" x 10"	AL
41187	10" x 14"	AL

NOTICE
CHEMICAL GOGGLES MUST BE WORN BEYOND THIS POINT

85032	10" x 14"	SS
22624	7" x 10"	PL
22625	10" x 14"	PL
41188	7" x 10"	AL

NOTICE
CLEAN AND STORE RESPIRATOR AFTER USE

128816	7" x 10"	SS
128819	10" x 14"	SS
128815	7" x 10"	PL
128818	10" x 14"	PL
128814	7" x 10"	AL
128817	10" x 14"	AL

Sign Selection Guide

- FB - Premium fiberglass (B-120)
- SS - Self-sticking polyester (B-302)
- PL - Plastic (B-401)
- AL - Aluminum (B-555)
- BGSS - BradyGlo™ self-stick polyester (B-324)
- BGPL - BradyGlo™ plastic (B-347)

Material Comparison page 408
Sign Legend Index..... page 588

NOTICE
DO NOT ENTER AREA UNLESS WEARING PROPER SAFETY EQUIPMENT

123577	7" x 10"	SS
123580	10" x 14"	SS
123576	7" x 10"	PL
123579	10" x 14"	PL
123575	7" x 10"	AL
123578	10" x 14"	AL

NOTICE
DO NOT OPERATE THIS EQUIPMENT WITHOUT EAR PROTECTION

70279	10" x 14"	FB
84808	7" x 10"	SS
84809	10" x 14"	SS
25484	7" x 10"	PL
25485	10" x 14"	PL
43061	7" x 10"	AL
43062	10" x 14"	AL

NOTICE
DUST RESPIRATOR MUST BE WORN ON THIS JOB

69179	10" x 14"	FB
88641	7" x 10"	SS
25224	7" x 10"	PL
25225	10" x 14"	PL
42801	7" x 10"	AL
42802	10" x 14"	AL

NOTICE
EAR PROTECTION MUST BE WORN BEYOND THIS POINT

69183	10" x 14"	FB
84810	7" x 10"	SS
84811	10" x 14"	SS
25486	7" x 10"	PL
25487	10" x 14"	PL
43063	7" x 10"	AL
43064	10" x 14"	AL

NOTICE
EAR PROTECTION MUST BE WORN WHILE WORKING AT THIS OPERATION

128822	7" x 10"	SS
128825	10" x 14"	SS
128821	7" x 10"	PL
128824	10" x 14"	PL
128820	7" x 10"	AL
128823	10" x 14"	AL

NOTICE
EAR PROTECTION REQUIRED IN THIS AREA

84812	7" x 10"	SS
84813	10" x 14"	SS
25488	7" x 10"	PL
25489	10" x 14"	PL
43065	7" x 10"	AL
43066	10" x 14"	AL

NOTICE
EAR PROTECTORS REQUIRED WHEN IN THIS AREA MORE THAN 15 MINUTES

128828	7" x 10"	SS
128831	10" x 14"	SS
128827	7" x 10"	PL
128830	10" x 14"	PL
128826	7" x 10"	AL
128829	10" x 14"	AL

NOTICE
EYE PROTECTION MUST BE WORN WHEN GRINDING

128834	7" x 10"	SS
128837	10" x 14"	SS
128833	7" x 10"	PL
128836	10" x 14"	PL
128832	7" x 10"	AL
128835	10" x 14"	AL

NOTICE
EYE PROTECTION REQUIRED

128840	7" x 10"	SS
128843	10" x 14"	SS
128839	7" x 10"	PL
128842	10" x 14"	PL
128838	7" x 10"	AL
128841	10" x 14"	AL

NOTICE
FACE SHIELD REQUIRED IN THIS AREA

128846	7" x 10"	SS
128849	10" x 14"	SS
128845	7" x 10"	PL
128848	10" x 14"	PL
128844	7" x 10"	AL
128847	10" x 14"	AL

NOTICE
FOLLOW FALL PROTECTION GUIDELINES WHEN WORKING BEYOND THIS POINT

128852	7" x 10"	SS
128855	10" x 14"	SS
128851	7" x 10"	PL
128854	10" x 14"	PL
128850	7" x 10"	AL
128853	10" x 14"	AL

NOTICE
HAIR COVERING REQUIRED IN THIS AREA

128858	7" x 10"	SS
128861	10" x 14"	SS
128857	7" x 10"	PL
128860	10" x 14"	PL
128856	7" x 10"	AL
128859	10" x 14"	AL

NOTICE
HAIR NET REQUIRED BEYOND THIS POINT

70362	10" x 14"	FB
88643	7" x 10"	SS
88644	10" x 14"	SS
25226	7" x 10"	PL
25227	10" x 14"	PL
42803	7" x 10"	AL
42804	10" x 14"	AL

NOTICE
HAIRNETS AND BEARD COVERS REQUIRED IN THIS AREA

128864	7" x 10"	SS
128867	10" x 14"	SS
128863	7" x 10"	PL
128866	10" x 14"	PL
128862	7" x 10"	AL
128865	10" x 14"	AL

NOTICE
HARD HATS AND EYE PROTECTION REQUIRED IN THIS AREA

128870	7" x 10"	SS
128873	10" x 14"	SS
128869	7" x 10"	PL
128872	10" x 14"	PL
128868	7" x 10"	AL
128871	10" x 14"	AL

NOTICE
HARD HATS AND FALL PROTECTION MUST BE WORN WHEN WORKING ON SCAFFOLDING

128948	10" x 7"	SS
128951	14" x 10"	SS
128947	10" x 7"	PL
128950	14" x 10"	PL
128946	10" x 7"	AL
128949	14" x 10"	AL

NOTICE
HARD HATS MUST BE WORN IN THIS AREA

70370	10" x 14"	FB
88645	7" x 10"	SS
88646	10" x 14"	SS
25228	7" x 10"	PL
25229	10" x 14"	PL
42806	10" x 14"	AL

NOTICE
HARD HATS MUST BE WORN ON THIS CONSTRUCTION PROJECT

60579	10" x 14"	SS
60540	10" x 14"	PL
60511	10" x 14"	AL

NOTICE
HARD HATS REQUIRED IN THIS AREA

70368	10" x 14"	FB
88647	7" x 10"	SS
88648	10" x 14"	SS
25230	7" x 10"	PL
25231	10" x 14"	PL
42807	7" x 10"	AL
42808	10" x 14"	AL

NOTICE
HEARING PROTECTION AND SAFETY GLASSES MUST BE WORN IN THIS AREA

128876	7" x 10"	SS
128879	10" x 14"	SS
128875	7" x 10"	PL
128878	10" x 14"	PL
128874	7" x 10"	AL
128877	10" x 14"	AL

NOTICE
HEARING PROTECTION MUST BE WORN IN THIS AREA

47305	7" x 10"	FB
47332	10" x 14"	FB
87777	3.5" x 5"	SS
84814	7" x 10"	SS
84815	10" x 14"	SS
25490	7" x 10"	PL
25491	10" x 14"	PL
43067	7" x 10"	AL
43068	10" x 14"	AL

NOTICE
HIGH IMPACT SAFETY GLASSES BEYOND THIS POINT

128882	7" x 10"	SS
128885	10" x 14"	SS
128881	7" x 10"	PL
128884	10" x 14"	PL
128880	7" x 10"	AL
128883	10" x 14"	AL

NOTICE
HIGH NOISE AREA WEAR EAR PLUGS

84816	7" x 10"	SS
84817	10" x 14"	SS
25493	10" x 14"	PL
43070	10" x 14"	AL

NOTICE
LIFE JACKETS MUST BE WORN BEYOND THIS POINT

128888	7" x 10"	SS
128891	10" x 14"	SS
128887	7" x 10"	PL
128890	10" x 14"	PL
128886	7" x 10"	AL
128889	10" x 14"	AL

Personal Protection Signs (continued)



87659 7" x 10" FB
59369 7" x 10" PL



84818 7" x 10" SS
25494 7" x 10" PL
25495 10" x 14" PL
43072 10" x 14" AL



128894 7" x 10" SS
128897 10" x 14" SS
128893 7" x 10" PL
128896 10" x 14" PL
128892 7" x 10" AL
128895 10" x 14" AL



70495 10" x 14" FB
88649 7" x 10" SS
25232 7" x 10" PL
25233 10" x 14" PL
42809 7" x 10" AL
42810 10" x 14" AL



123571 7" x 10" SS
123574 10" x 14" SS
123570 7" x 10" PL
123573 10" x 14" PL
123569 7" x 10" AL
123572 10" x 14" AL



70507 7" x 17" FB



128906 7" x 10" SS
128909 10" x 14" SS
128905 7" x 10" PL
128908 10" x 14" PL
128904 7" x 10" AL
128907 10" x 14" AL



128912 7" x 10" SS
128915 10" x 14" SS
128911 7" x 10" PL
128914 10" x 14" PL
128910 7" x 10" AL
128913 10" x 14" AL



128900 7" x 10" SS
128903 10" x 14" SS
128899 7" x 10" PL
128902 10" x 14" PL
128898 7" x 10" AL
128901 10" x 14" AL



47307 7" x 10" FB
47334 10" x 14" FB
87779 3.5" x 5" SS
85035 7" x 10" SS
85036 10" x 14" SS
22626 7" x 10" PL
22627 10" x 14" PL
41190 7" x 10" AL
41191 10" x 14" AL



47333 10" x 14" FB
87781 3.5" x 5" SS
85038 10" x 14" SS
22628 7" x 10" PL
22629 10" x 14" PL
41192 7" x 10" AL
41193 10" x 14" AL



70523 7" x 17" FB



128918 7" x 10" SS
128921 10" x 14" SS
128917 7" x 10" PL
128920 10" x 14" PL
128916 7" x 10" AL
128919 10" x 14" AL



69487 10" x 14" FB
88651 7" x 10" SS
88652 10" x 14" SS
25234 7" x 10" PL
25235 10" x 14" PL
42811 7" x 10" AL
42812 10" x 14" AL



69494 10" x 14" FB
85039 7" x 10" SS
85040 10" x 14" SS
22630 7" x 10" PL
22631 10" x 14" PL
41194 7" x 10" AL
41195 10" x 14" AL



128426 7" x 10" SS
128429 10" x 14" SS
128425 7" x 10" PL
128428 10" x 14" PL
128424 7" x 10" AL
128427 10" x 14" AL



74337 10" x 14" FB
85041 7" x 10" SS
85042 10" x 14" SS
25570 7" x 10" PL
25571 10" x 14" PL
43147 7" x 10" AL
43148 10" x 14" AL



128924 7" x 10" SS
128927 10" x 14" SS
128923 7" x 10" PL
128926 10" x 14" PL
128922 7" x 10" AL
128925 10" x 14" AL



69546 10" x 14" FB
85129 7" x 10" SS
85130 10" x 14" SS
25626 7" x 10" PL
25627 10" x 14" PL
43203 7" x 10" AL
43204 10" x 14" AL



128930 7" x 10" SS
128933 10" x 14" SS
128929 7" x 10" PL
128932 10" x 14" PL
128928 7" x 10" AL
128931 10" x 14" AL



128936 7" x 10" SS
128939 10" x 14" SS
128935 7" x 10" PL
128938 10" x 14" PL
128934 7" x 10" AL
128937 10" x 14" AL



88656 10" x 14" SS
42816 10" x 14" AL



128942 7" x 10" SS
128945 10" x 14" SS
128941 7" x 10" PL
128944 10" x 14" PL
128940 7" x 10" AL
128943 10" x 14" AL



73475 10" x 14" FB



69182 10" x 14" FB
25496 7" x 10" PL



73455 14" x 20" FB
85045 7" x 10" SS
85046 10" x 14" SS
25574 7" x 10" PL
25575 10" x 14" PL
43151 7" x 10" AL
43152 10" x 14" AL



70336 14" x 20" FB
85049 7" x 10" SS
85050 10" x 14" SS
25576 7" x 10" PL
25577 10" x 14" PL
43153 7" x 10" AL
43154 10" x 14" AL



70338 7" x 10" FB
85051 7" x 10" SS
85052 10" x 14" SS
25578 7" x 10" PL
25579 10" x 14" PL
43155 7" x 10" AL
43156 10" x 14" AL



47375 7" x 10" FB
69255 10" x 14" FB
88659 7" x 10" SS
88660 10" x 14" SS
25241 10" x 14" PL
42817 7" x 10" AL

Personal Protection Signs

BradyID.com/s36

Personal Protection Signs (continued)



69215	10" x 14"	FB
88661	7" x 10"	SS
88662	10" x 14"	SS
25243	10" x 14"	PL
42819	7" x 10"	AL
42820	10" x 14"	AL



123829	7" x 10"	SS
123832	10" x 14"	SS
123828	7" x 10"	PL
123831	10" x 14"	PL
123827	7" x 10"	AL
123830	10" x 14"	AL



69481	10" x 14"	FB
88663	7" x 10"	SS
88664	10" x 14"	SS
25244	7" x 10"	PL
25245	10" x 14"	PL
42821	7" x 10"	AL
42822	10" x 14"	AL



128966	7" x 10"	SS
128969	10" x 14"	SS
128965	7" x 10"	PL
128968	10" x 14"	PL
128964	7" x 10"	AL
128967	10" x 14"	AL

Sign Selection Guide

- FB - Premium fiberglass (B-120)
- SS - Self-sticking polyester (B-302)
- PL - Plastic (B-401)
- AL - Aluminum (B-555)
- BGSS - BradyGlo™ self-stick polyester (B-324)
- BGPL - BradyGlo™ plastic (B-347)

Material Comparison page 408
Sign Legend Index..... page 588



85053	7" x 10"	SS
85054	10" x 14"	SS
25581	10" x 14"	PL
43157	7" x 10"	AL
43158	10" x 14"	AL



122859	7" x 10"	FB
74479	10" x 14"	FB
85055	7" x 10"	SS
85056	10" x 14"	SS
122526	7" x 10"	PL
25583	10" x 14"	PL
43159	7" x 10"	AL
43160	10" x 14"	AL



128954	7" x 10"	SS
128957	10" x 14"	SS
128953	7" x 10"	PL
128956	10" x 14"	PL
128952	7" x 10"	AL
128955	10" x 14"	AL



128960	10" x 7"	SS
128963	14" x 10"	SS
128959	10" x 7"	PL
128962	14" x 10"	PL
128958	10" x 7"	AL
128961	14" x 10"	AL



128972	7" x 10"	SS
128975	10" x 14"	SS
128971	7" x 10"	PL
128974	10" x 14"	PL
128970	7" x 10"	AL
128973	10" x 14"	AL



69579	10" x 14"	FB
84822	7" x 10"	SS
84823	10" x 14"	SS
25498	7" x 10"	PL
25499	10" x 14"	PL
43075	7" x 10"	AL
43076	10" x 14"	AL



33796	10" x 14"	SS
33799	10" x 14"	AL
33795	10" x 14"	SSV



128978	7" x 10"	SS
128981	10" x 14"	SS
128977	7" x 10"	PL
128980	10" x 14"	PL
128976	7" x 10"	AL
128979	10" x 14"	AL



128984	7" x 10"	SS
128987	10" x 14"	SS
128983	7" x 10"	PL
128986	10" x 14"	PL
128982	7" x 10"	AL
128985	10" x 14"	AL



69581	10" x 14"	FB
85057	7" x 10"	SS
85058	10" x 14"	SS
25584	7" x 10"	PL
25585	10" x 14"	PL
43161	7" x 10"	AL
43162	10" x 14"	AL



33341	10" x 14"	PL
33344	10" x 14"	SS



129134	7" x 10"	SS
129137	10" x 14"	SS
129133	7" x 10"	PL
129136	10" x 14"	PL
129132	7" x 10"	AL
129135	10" x 14"	AL



69584	10" x 14"	FB
88669	7" x 10"	SS
88670	10" x 14"	SS
25246	7" x 10"	PL
25247	10" x 14"	PL
42823	7" x 10"	AL
42824	10" x 14"	AL



128990	7" x 10"	SS
128993	10" x 14"	SS
128989	7" x 10"	PL
128992	10" x 14"	PL
128988	7" x 10"	AL
128991	10" x 14"	AL



128996	7" x 10"	SS
128999	10" x 14"	SS
128995	7" x 10"	PL
128998	10" x 14"	PL
128994	7" x 10"	AL
128997	10" x 14"	AL



129002	7" x 10"	SS
129005	10" x 14"	SS
129001	7" x 10"	PL
129004	10" x 14"	PL
129000	7" x 10"	AL
129003	10" x 14"	AL



129008	7" x 10"	SS
129011	10" x 14"	SS
129007	7" x 10"	PL
129010	10" x 14"	PL
129006	7" x 10"	AL
129009	10" x 14"	AL



129020	7" x 10"	SS
129023	10" x 14"	SS
129019	7" x 10"	PL
129022	10" x 14"	PL
129018	7" x 10"	AL
129021	10" x 14"	AL



129014	7" x 10"	SS
129017	10" x 14"	SS
129013	7" x 10"	PL
129016	10" x 14"	PL
129012	7" x 10"	AL
129015	10" x 14"	AL



90720	10" x 14"	BGPL
-------	-----------	------



85066	3.5" x 10"	SS
-------	------------	----

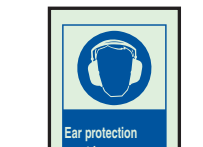

90731	10" x 14"	BGPL
-------	-----------	------



90139	10" x 7"	BGSS
-------	----------	------



90121	7" x 10"	BGSS
-------	----------	------

Safety Signs

Personal Protection Signs

BradyID.com/s36

Personal Protection Signs (continued)



**EAR PROTECTION
REQUIRED
BEYOND THIS POINT**

69799	7" x 7"	FB
84551	2.25" x 2.25"	SS
88495	7" x 7"	SS
25161	7" x 10"	PL
42738	7" x 10"	AL

73410	10" x 14"	FB
84824	7" x 10"	SS
84825	10" x 14"	SS
43078	10" x 14"	AL

**EYE AND EAR
PROTECTION
MUST BE WORN IN
THIS DEPARTMENT
AT ALL TIMES**

128462	7" x 10"	SS
128465	10" x 14"	SS
128461	7" x 10"	PL
128464	10" x 14"	PL
128460	7" x 10"	AL
128463	10" x 14"	AL



69800	7" x 7"	FB
25166	7" x 10"	PL
42743	7" x 10"	AL



84549	2.25" x 2.25"	SS
-------	---------------	----



90196	10" x 14"	BGSS
90727	10" x 14"	BGPL



90644	10" x 7"	BGPL
-------	----------	------

**EYE PROTECTION REQUIRED
SAFETY GLASSES**

85069	3.5" x 10"	SS
-------	------------	----

**EYE PROTECTION
SHALL BE WORN
IN THIS AREA**

74982	10" x 14"	FB
25589	7" x 10"	PL

**EYE PROTECTION
SHALL BE WORN
WHEN OPERATING
THIS MACHINE**

74170	7" x 10"	FB
85070	7" x 10"	SS
85071	10" x 14"	SS
25591	7" x 10"	PL
25592	10" x 14"	PL
43168	7" x 10"	AL



84552	2.25" x 2.25"	SS
-------	---------------	----



90960	7" x 10"	BGPL
-------	----------	------

FALL HAZARD
DO NOT
START WORK UNLESS
GUARDRAIL, SAFETY NET,
OR PERSONAL FALL
ARREST SYSTEM
IS IN PLACE

128468	7" x 10"	SS
128471	10" x 14"	SS
128467	7" x 10"	PL
128470	10" x 14"	PL
128466	7" x 10"	AL
128469	10" x 14"	AL



84550	2.25" x 2.25"	SS
-------	---------------	----



84555	2.25" x 2.25"	SS
-------	---------------	----

**HAIR AND
BEARD NETS
REQUIRED**

128474	7" x 10"	SS
128477	10" x 14"	SS
128473	7" x 10"	PL
128476	10" x 14"	PL
128472	7" x 10"	AL
128475	10" x 14"	AL

**HARD HAT
AREA**

70366	10" x 14"	FB
88677	7" x 10"	SS
88678	10" x 14"	SS
25248	7" x 10"	PL
42826	10" x 14"	AL



69006	7" x 7"	FB
88511	7" x 7"	SS
25175	7" x 10"	PL
42752	7" x 10"	AL



60573	10" x 14"	SS
25899	10" x 14"	PL
43476	10" x 14"	AL



84548	2.25" x 2.25"	SS
-------	---------------	----

**HARD HATS
REQUIRED ON THIS
JOB BY ALL
EMPLOYEES**

128480	7" x 10"	SS
128483	10" x 14"	SS
128479	7" x 10"	PL
128482	10" x 14"	PL
128478	7" x 10"	AL
128481	10" x 14"	AL

**HARD HATS
REQUIRED
WHEN THIS
EQUIPMENT
IS OPERATING**

128486	7" x 10"	SS
128489	10" x 14"	SS
128485	7" x 10"	PL
128488	10" x 14"	PL
128484	7" x 10"	AL
128487	10" x 14"	AL



90723	10" x 14"	BGPL
-------	-----------	------

**HEARING
PROTECTION
REQUIRED HERE**

84826	3.5" x 10"	SS
-------	------------	----

**More Than Anyone
Keeps Your Safety
Top of Mind**

124624	5" x 14"	SS
124623	5" x 14"	PL
124622	5" x 14"	AL

**PERSONAL PROTECTIVE
EQUIPMENT IS PROVIDED
USE IT!**

90584	5" x 14"	BGSS
-------	----------	------

**PERSONAL
PROTECTIVE
EQUIPMENT
STORED HERE**

128492	7" x 10"	SS
128495	10" x 14"	SS
128491	7" x 10"	PL
128494	10" x 14"	PL
128490	7" x 10"	AL
128493	10" x 14"	AL



Personal Protection Signs

BradyID.com/s36

Personal Protection Signs (continued)



123823	10" x 7"	SS
123826	14" x 10"	SS
123822	10" x 7"	PL
123825	14" x 10"	PL
123821	10" x 7"	AL
123824	14" x 10"	AL



90587	5" x 14"	BGSS
90785	5" x 14"	BGPL



84554	2.25" x 2.25"	SS
-------	---------------	----



69470	7" x 7"	FB
88525	7" x 7"	SS
25186	7" x 10"	PL
42763	7" x 10"	AL

Sign Selection Guide

FB - Premium fiberglass (B-120)
SS - Self-sticking polyester (B-302)
PL - Plastic (B-401)
AL - Aluminum (B-555)
BGSS - BradyGlo™ self-stick polyester (B-324)
BGPL - BradyGlo™ plastic (B-347)

Material Comparison page 408
Sign Legend Index..... page 588



128498	7" x 10"	SS
128501	10" x 14"	SS
128497	7" x 10"	PL
128500	10" x 14"	PL
128496	7" x 10"	AL
128499	10" x 14"	AL



90112	7" x 10"	BGSS
-------	----------	------



84553	2.25" x 2.25"	SS
-------	---------------	----



88527	7" x 7"	SS
25188	7" x 10"	PL
42765	7" x 10"	AL



128678	18" x 18"	SS
128681	24" x 24"	SS
128677	18" x 18"	PL
128676	18" x 18"	AL
128679	24" x 24"	AL



128690	18" x 18"	SS
128693	24" x 24"	SS
128689	18" x 18"	PL
128688	18" x 18"	AL
128691	24" x 24"	AL



124539	18" x 18"	PL
124541	24" x 24"	PL
124538	18" x 18"	AL
124540	24" x 24"	AL



124551	18" x 18"	PL
124553	24" x 24"	PL
124550	18" x 18"	AL
124552	24" x 24"	AL



128684	18" x 18"	SS
128687	24" x 24"	SS
128683	18" x 18"	PL
128686	24" x 24"	PL
128682	18" x 18"	AL
128685	24" x 24"	AL



124543	18" x 18"	PL
124545	24" x 24"	PL
124542	18" x 18"	AL
124544	24" x 24"	AL



124527	18" x 18"	PL
124529	24" x 24"	PL
124526	18" x 18"	AL
124528	24" x 24"	AL



90722	14" x 10"	BGPL
-------	-----------	------



90643	10" x 7"	BGPL
90725	14" x 10"	BGPL



90128	10" x 7"	BGSS
90721	14" x 10"	BGPL



85072	3.5" x 10"	SS
-------	------------	----



85074	3.5" x 10"	SS
-------	------------	----



85076	3.5" x 10"	SS
-------	------------	----



85075	3.5" x 10"	SS
-------	------------	----



90729	14" x 10"	BGPL
-------	-----------	------



90199	14" x 10"	BGSS
-------	-----------	------



128504	7" x 10"	SS
128507	10" x 14"	SS
128503	7" x 10"	PL
128506	10" x 14"	PL
128502	7" x 10"	AL
128505	10" x 14"	AL



88684	3.5" x 10"	SS
-------	------------	----



128510	7" x 10"	SS
128513	10" x 14"	SS
128509	7" x 10"	PL
128512	10" x 14"	PL
128508	7" x 10"	AL
128511	10" x 14"	AL



Safety Signs

Radiation and Laser Signs

Brady radiation signs can help you comply with OSHA's regulations for radiation safety and laser warnings. These radiation signs offer messages for radiation danger, microwave warning signs and other radioactive warning safety signs. Radiation signs can be placed around your facility where radiation and x-ray safety are concerns.

Regulations

Radioactive Area 1910.1096(e)(2)

Each radiation area shall be conspicuously posted with a sign or signs bearing the radiation caution symbol described in subparagraph (1) of this paragraph and the words: CAUTION RADIATION AREA.

High Radiation Area 1910.1096(e)(3)(i)

Each high radiation area shall be conspicuously posted with a sign or signs bearing the radiation caution symbol and the words: CAUTION HIGH RADIATION AREA



129158	7" x 10"	SS
129161	10" x 14"	SS
129157	7" x 10"	PL
129160	10" x 14"	PL
129156	7" x 10"	AL
129159	10" x 14"	AL



129278	10" x 7"	SS
129281	14" x 10"	SS
129277	10" x 7"	PL
129280	14" x 10"	PL
129276	10" x 7"	AL
129279	14" x 10"	AL



129242	7" x 10"	SS
129245	10" x 14"	SS
129241	7" x 10"	PL
129244	10" x 14"	PL
129240	7" x 10"	AL
129243	10" x 14"	AL



88691	7" x 10"	SS
25254	7" x 10"	PL
25255	10" x 14"	PL



129164	7" x 10"	SS
129167	10" x 14"	SS
129163	7" x 10"	PL
129166	10" x 14"	PL
129162	7" x 10"	AL
129165	10" x 14"	AL



129176	7" x 10"	SS
129179	10" x 14"	SS
129175	7" x 10"	PL
129178	10" x 14"	PL
129174	7" x 10"	AL
129177	10" x 14"	AL



76082	10" x 14"	FB
88699	7" x 10"	SS
88700	10" x 14"	SS
25256	7" x 10"	PL
25257	10" x 14"	PL
42833	7" x 10"	AL
42834	10" x 14"	AL



88702	10" x 14"	SS
-------	-----------	----



129236	7" x 10"	SS
129239	10" x 14"	SS
129235	7" x 10"	PL
129238	10" x 14"	PL
129234	7" x 10"	AL
129237	10" x 14"	AL

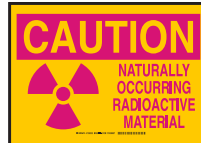

129230	7" x 10"	SS
129233	10" x 14"	SS
129229	7" x 10"	PL
129232	10" x 14"	PL
129228	7" x 10"	AL
129231	10" x 14"	AL



129182	7" x 10"	SS
129185	10" x 14"	SS
129181	7" x 10"	PL
129184	10" x 14"	PL
129180	7" x 10"	AL
129183	10" x 14"	AL



129248	7" x 10"	SS
129251	10" x 14"	SS
129247	7" x 10"	PL
129250	10" x 14"	PL
129246	7" x 10"	AL
129249	10" x 14"	AL



129188	7" x 10"	SS
129191	10" x 14"	SS
129187	7" x 10"	PL
129190	10" x 14"	PL
129186	7" x 10"	AL
129189	10" x 14"	AL



95755	7" x 10"	FB
62950	10" x 14"	FB
62954	10" x 14"	SS
62951	7" x 10"	PL
62952	10" x 14"	PL
67992	10" x 14"	AL



129260	7" x 10"	SS
129263	10" x 14"	SS
129259	7" x 10"	PL
129262	10" x 14"	PL
129258	7" x 10"	AL
129261	10" x 14"	AL



42835	7" x 10"	AL
42836	10" x 14"	AL
88707	7" x 10"	SS
88708	10" x 14"	SS
25258	7" x 10"	PL
25259	10" x 14"	PL



70416	10" x 14"	FB
88709	7" x 10"	SS
88710	10" x 14"	SS
25260	7" x 10"	PL
25261	10" x 14"	PL
42837	7" x 10"	AL
42838	10" x 14"	AL



129266	7" x 10"	SS
129269	10" x 14"	SS
129265	7" x 10"	PL
129268	10" x 14"	PL
129264	7" x 10"	AL
129267	10" x 14"	AL



25263	10" x 14"	PL
42840	10" x 14"	AL



129254	7" x 10"	SS
129257	10" x 14"	SS
129253	7" x 10"	PL
129256	10" x 14"	PL
129252	7" x 10"	AL
129255	10" x 14"	AL



76081	10" x 14"	FB
88715	7" x 10"	SS
25264	7" x 10"	PL
25265	10" x 14"	PL
42841	7" x 10"	AL
42842	10" x 14"	AL



88717	7" x 10"	SS
88718	10" x 14"	SS
25266	7" x 10"	PL
25267	10" x 14"	PL
42843	7" x 10"	AL



88725	7" x 10"	SS
88726	10" x 14"	SS
25268	7" x 10"	PL
25269	10" x 14"	PL
42845	7" x 10"	AL
42846	10" x 14"	AL

Radiation and Laser Signs

BradyID.com/s36

Radiation and Laser Signs (continued)



129272	7" x 10"	SS
129275	10" x 14"	SS
129271	7" x 10"	PL
129274	10" x 14"	PL
129270	7" x 10"	AL
129273	10" x 14"	AL



129284	7" x 10"	SS
129287	10" x 14"	SS
129283	7" x 10"	PL
129286	10" x 14"	PL
129282	7" x 10"	AL
129285	10" x 14"	AL



129290	7" x 10"	SS
129293	10" x 14"	SS
129289	7" x 10"	PL
129292	10" x 14"	PL
129288	7" x 10"	AL
129291	10" x 14"	AL



129296	7" x 10"	SS
129299	10" x 14"	SS
129295	7" x 10"	PL
129298	10" x 14"	PL
129294	7" x 10"	AL
129297	10" x 14"	AL

Sign Selection Guide

- FB - Premium fiberglass (B-120)
- SS - Self-sticking polyester (B-302)
- PL - Plastic (B-401)
- AL - Aluminum (B-555)
- BGSS - BradyGlo™ self-stick polyester (B-324)
- BGPL - BradyGlo™ plastic (B-347)

Material Comparison page 408
Sign Legend Index..... page 588



129302	7" x 10"	SS
129305	10" x 14"	SS
129301	7" x 10"	PL
129304	10" x 14"	PL
129300	7" x 10"	AL
129303	10" x 14"	AL



69437	10" x 14"	FB
84583	7" x 10"	SS
22443	7" x 10"	PL
41007	7" x 10"	AL
41008	10" x 14"	AL



129308	10" x 7"	SS
129311	14" x 10"	SS
129307	10" x 7"	PL
129310	14" x 10"	PL
129306	10" x 7"	AL
129309	14" x 10"	AL



84586	10" x 14"	SS
22445	7" x 10"	PL
22446	10" x 14"	PL



129320	7" x 10"	SS
129323	10" x 14"	SS
129319	7" x 10"	PL
129322	10" x 14"	PL
129318	7" x 10"	AL
129321	10" x 14"	AL



129314	10" x 7"	SS
129317	14" x 10"	SS
129313	10" x 7"	PL
129316	14" x 10"	PL
129312	10" x 7"	AL



129326	7" x 10"	SS
129329	10" x 14"	SS
129325	7" x 10"	PL
129328	10" x 14"	PL
129324	7" x 10"	AL
129327	10" x 14"	AL



129332	7" x 10"	SS
129335	10" x 14"	SS
129331	7" x 10"	PL
129334	10" x 14"	PL
129330	7" x 10"	AL
129333	10" x 14"	AL



129338	7" x 10"	SS
129341	10" x 14"	SS
129337	7" x 10"	PL
129340	10" x 14"	PL
129336	7" x 10"	AL
129339	10" x 14"	AL



124183	10" x 7"	SS
124186	14" x 10"	SS
124182	10" x 7"	PL
124185	14" x 10"	PL
124181	10" x 7"	AL
124184	14" x 10"	AL



124300	10" x 7"	SS
124303	14" x 10"	SS
124299	10" x 7"	PL
124302	14" x 10"	PL
124298	10" x 7"	AL
124301	14" x 10"	AL



88731	7" x 10"	SS
25270	7" x 10"	PL

Safety Signs



88733	10" x 7"	SS
88734	14" x 10"	SS
25272	10" x 7"	PL
25273	14" x 10"	PL
42849	10" x 7"	AL
42850	14" x 10"	AL



88736	7" x 10"	SS
88737	10" x 14"	SS
25274	7" x 10"	PL
25275	10" x 14"	PL



122777	10" x 7"	FB
74829	14" x 10"	FB
88738	10" x 7"	SS
88739	14" x 10"	SS
25276	10" x 7"	PL
25277	14" x 10"	PL
42853	10" x 7"	AL
42854	14" x 10"	AL



74837	7" x 10"	FB
88741	7" x 10"	SS
88742	10" x 14"	SS
25278	7" x 10"	PL
25279	10" x 14"	PL
42855	7" x 10"	AL
42856	10" x 14"	AL



88740	3.5" x 10"	SS
-------	------------	----



74844	14" x 20"	FB
88743	7" x 10"	SS
25280	7" x 10"	PL
25281	10" x 14"	PL
42857	7" x 10"	AL
42858	10" x 14"	AL



124231	10" x 7"	SS
124234	14" x 10"	SS
124230	10" x 7"	PL
124233	14" x 10"	PL
124229	10" x 7"	AL
124232	14" x 10"	AL



74850	14" x 20"	FB
88746	7" x 10"	SS
88747	10" x 14"	SS
25282	7" x 10"	PL
25283	10" x 14"	PL
42859	7" x 10"	AL
42860	10" x 14"	AL



89112	2.25" x 2.25"	SS
88750	3.5" x 10"	SS
88751	5" x 14"	SS



74855	7" x 10"	FB
122717	10" x 14"	FB
88748	7" x 10"	SS
88749	10" x 14"	SS
25284	7" x 10"	PL
25285	10" x 14"	PL
42861	7" x 10"	AL
42862	10" x 14"	AL



88745	2.25" x 2.25"	SS
-------	---------------	----



89171	2.25" x 2.25"	SS
88752	3.5" x 10"	SS

Radiation and Laser Signs

BradyID.com/s36

Radiation and Laser Signs (continued)



74900	14" x 20"	FB
25286	7" x 10"	PL
42863	7" x 10"	AL



74886	5" x 14"	FB
122849	7" x 10"	FB
122719	10" x 14"	FB
88762	5" x 14"	SS
122653	7" x 10"	SS
122578	10" x 14"	SS
122522	7" x 10"	PL
25288	10" x 14"	PL
42865	10" x 14"	AL



88767	7" x 10"	SS
88768	10" x 14"	SS
25289	7" x 10"	PL
74907	7" x 10"	FB
42867	10" x 14"	AL



129200	7" x 10"	SS
129203	10" x 14"	SS
129199	7" x 10"	PL
129202	10" x 14"	PL
129198	7" x 10"	AL
129201	10" x 14"	AL

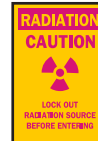

88769	10" x 7"	SS
88770	14" x 10"	SS
25291	10" x 7"	PL
25292	14" x 10"	PL
42868	10" x 7"	AL
42869	14" x 10"	AL



88936	2.25" x 9"	SS
88937	3.5" x 10"	SS
88938	5" x 14"	SS



129206	10" x 7"	SS
129209	14" x 10"	SS
129205	10" x 7"	PL
129208	14" x 10"	PL
129204	10" x 7"	AL
129207	14" x 10"	AL



129212	10" x 7"	SS
129215	14" x 10"	SS
129211	10" x 7"	PL
129214	14" x 10"	PL
129210	10" x 7"	AL
129213	14" x 10"	AL



129218	10" x 7"	SS
129221	14" x 10"	SS
129217	10" x 7"	PL
129220	14" x 10"	PL
129216	10" x 7"	AL
129219	14" x 10"	AL



129224	7" x 10"	SS
129227	10" x 14"	SS
129223	7" x 10"	PL
129226	10" x 14"	PL
129222	7" x 10"	AL
129225	10" x 14"	AL



129344	18" x 18"	SS
129343	18" x 18"	PL
129342	18" x 18"	AL

Nuclear Insert Signs

- Insert signs capable of holding multiple messages
- Durable subsurface printed on polycarbonate material
- Sharply contrasting magenta on yellow CAUTION header with radiation symbol
- Thumb notch at pocket opening allows for easy removal of the insert
- Snap-in design holds inserts lightly
- Available with nylon clamps for hanging or brass grommets for wall mounting

Catalog #	Size	Description	Qty
(See below)	1.68" x 8"	Polycarbonate Sign Inserts	5
93600	12" x 8"	3-Pocket Caution Insert Holder	1
93602	16" x 8"	5-Pocket Caution Insert Holder	1



Signs provide precise hazard warning by enabling you to include up to 5 messages per sign.



93634	1.68" x 8"
-------	------------



93620	1.68" x 8"
-------	------------



93636	1.68" x 8"
-------	------------



93625	1.68" x 8"
-------	------------



93637	1.68" x 8"
-------	------------



93619	1.68" x 8"
-------	------------



93629	1.68" x 8"
-------	------------



93631	1.68" x 8"
-------	------------



93640	1.68" x 8"
-------	------------



93627	1.68" x 8"
-------	------------



93616	1.68" x 8"
-------	------------

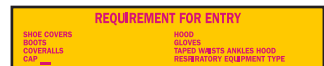

93638	1.68" x 8"
-------	------------



93621	1.68" x 8"
-------	------------



93611	1.68" x 8"
-------	------------

Safety Signs

Recycle and Environment

BradyID.com/s36

Recycle and Environment Signs

Brady offers a full line of recycling signs for an environmentally responsible facility. Recycle signs can be placed in designated areas for recycling.

Sign Selection Guide

- FB** - Premium fiberglass (B-120)
- SS** - Self-sticking polyester (B-302)
- PL** - Plastic (B-401)
- AL** - Aluminum (B-555)
- SSV** - Self-Sticking Vinyl (B-946)

Material Comparison page 408
Sign Legend Index..... page 588



73478	10" x 14"	FB
86023	7" x 10"	SS
86024	10" x 14"	SS
25943	7" x 10"	PL
25944	10" x 14"	PL



129389	10" x 7"	SS
129392	14" x 10"	SS
129388	10" x 7"	PL
129391	14" x 10"	PL
129387	10" x 7"	AL
129390	14" x 10"	AL



86027	7" x 10"	SS
25947	7" x 10"	PL
41972	7" x 10"	AL



129353	10" x 7"	SS
129356	14" x 10"	SS
129352	10" x 7"	PL
129355	14" x 10"	PL
129351	10" x 7"	AL
129354	14" x 10"	AL



129359	10" x 7"	SS
129362	14" x 10"	SS
129358	10" x 7"	PL
129361	14" x 10"	PL
129357	10" x 7"	AL
129360	14" x 10"	AL



129365	10" x 7"	SS
129368	14" x 10"	SS
129364	10" x 7"	PL
129367	14" x 10"	PL
129363	10" x 7"	AL
129366	14" x 10"	AL



129347	7" x 10"	SS
129350	10" x 14"	SS
129346	7" x 10"	PL
129349	10" x 14"	PL
129345	7" x 10"	AL
129348	10" x 14"	AL



129371	10" x 7"	SS
129374	14" x 10"	SS
129370	10" x 7"	PL
129373	14" x 10"	PL
129369	10" x 7"	AL
129372	14" x 10"	AL



123516	7" x 10"	SS
123519	10" x 14"	SS
123515	7" x 10"	PL
123518	10" x 14"	PL
123514	7" x 10"	AL
123517	10" x 14"	AL



76879	12" x 12"	FB
22451	7" x 10"	PL



123947	7" x 10"	SS
123950	10" x 14"	SS
123946	7" x 10"	PL
123949	10" x 14"	PL
123945	7" x 10"	AL
123948	10" x 14"	AL



123559	10" x 7"	SS
123562	14" x 10"	SS
123558	10" x 7"	PL
123561	14" x 10"	PL
123557	10" x 7"	AL
123560	14" x 10"	AL



129377	10" x 7"	SS
129380	14" x 10"	SS
129376	10" x 7"	PL
129379	14" x 10"	PL
129375	10" x 7"	AL
129378	14" x 10"	AL



129383	10" x 7"	SS
129386	14" x 10"	SS
129382	10" x 7"	PL
129385	14" x 10"	PL
129381	10" x 7"	AL
129384	14" x 10"	AL



86025	7" x 10"	SS
25945	7" x 10"	PL
25946	10" x 14"	PL



129395	10" x 7"	SS
129398	14" x 10"	SS
129394	10" x 7"	PL
129397	14" x 10"	PL
129393	10" x 7"	AL
129396	14" x 10"	AL



86029	7" x 10"	SS
25950	10" x 14"	PL



123967	10" x 7"	SS
123970	14" x 10"	SS
123966	10" x 7"	PL
123969	14" x 10"	PL
123965	10" x 7"	AL
123968	14" x 10"	AL



73477	10" x 14"	FB
86013	7" x 10"	SS
86014	10" x 14"	SS
25933	7" x 10"	PL
25934	10" x 14"	PL
41959	10" x 14"	AL



73426	7" x 10"	FB
70612	10" x 14"	FB
86011	7" x 10"	SS
86012	10" x 14"	SS
41956	7" x 10"	AL



70617	7" x 10"	FB
86018	10" x 14"	SS
41963	10" x 14"	AL



70609	7" x 10"	FB
70610	10" x 14"	FB
86009	7" x 10"	SS
86010	10" x 14"	SS
25929	7" x 10"	PL
25930	10" x 14"	PL



70608	10" x 14"	FB
86007	7" x 10"	SS
86008	10" x 14"	SS
25927	7" x 10"	PL
25928	10" x 14"	PL
41952	7" x 10"	AL
41953	10" x 14"	AL



84601	10" x 14"	SS
-------	-----------	----



84602	10" x 14"	SS
-------	-----------	----



84603	10" x 14"	SS
-------	-----------	----



84604	10" x 14"	SS
-------	-----------	----



84605	10" x 14"	SS
-------	-----------	----



70616	10" x 14"	FB
86015	7" x 10"	SS
86016	10" x 14"	SS
25936	10" x 14"	PL
41961	10" x 14"	AL



123961	10" x 7"	SS
123964	14" x 10"	SS
123960	10" x 7"	PL
123963	14" x 10"	PL
123959	10" x 7"	AL
123962	14" x 10"	AL



124633	3.5" x 10"	SS
124632	3.5" x 10"	PL
124631	3.5" x 10"	AL

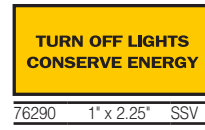

76290	1" x 2.25"	SSV
-------	------------	-----

Safety Signs

Restroom Signs

Brady's restroom signs easily identify your facility's restrooms. These signs feature bold lettering and universal pictograms. Brady has over 20 different pictogram and stock legends for restroom signs in various sizes, color, languages and materials, including signs that identify handicap access.



129401	10" x 7"	SS
129404	14" x 10"	SS
129400	10" x 7"	PL
129403	14" x 10"	PL
129399	10" x 7"	AL
129402	14" x 10"	AL



123979	7" x 10"	SS
123982	10" x 14"	SS
123978	7" x 10"	PL
123981	10" x 14"	PL
123977	7" x 10"	AL
123980	10" x 14"	AL



123985	7" x 10"	SS
123988	10" x 14"	SS
123984	7" x 10"	PL
123987	10" x 14"	PL
123983	7" x 10"	AL
123986	10" x 14"	AL



123973	7" x 10"	SS
123976	10" x 14"	SS
123972	7" x 10"	PL
123975	10" x 14"	PL
123971	7" x 10"	AL
123974	10" x 14"	AL



84234	3.5" x 10"	SS
-------	------------	----



132100	7" x 10"	FB
47668	7" x 10"	SS
47670	7" x 10"	PL
47671	7" x 10"	AL



47699	7" x 10"	SS
47701	7" x 10"	PL
47708	7" x 10"	AL



47725	10" x 7"	SS
47727	10" x 7"	PL
47728	10" x 7"	AL

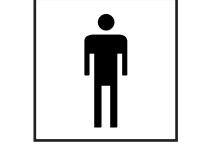

88516	7" x 7"	SS
44607	6" x 6"	Acrylic
25178	7" x 10"	PL
42755	7" x 10"	AL



70426	4" x 12"	FB
-------	----------	----



25917	10" x 14"	PL
43493	10" x 14"	AL



124639	3.5" x 10"	SS
124638	3.5" x 10"	PL
124637	3.5" x 10"	AL



124636	3.5" x 10"	SS
124635	3.5" x 10"	PL
124634	3.5" x 10"	AL



47685	7" x 10"	SS
47690	7" x 10"	PL
47691	7" x 10"	AL



70508	4" x 12"	FB
-------	----------	----



25918	10" x 14"	PL
43494	10" x 14"	AL



91319	6" x 12"	FB
89128	6" x 12"	SS



123881	7" x 10"	SS
123884	10" x 14"	SS
123880	7" x 10"	PL
123883	10" x 14"	PL
123879	7" x 10"	AL
123882	10" x 14"	AL



87719	10" x 14"	FB
47538	10" x 14"	SS
47551	10" x 14"	PL
47555	10" x 14"	AL



87718	10" x 14"	FB
47546	10" x 14"	SS
47540	10" x 14"	PL



132101	7" x 10"	FB
47674	7" x 10"	SS
47676	7" x 10"	PL
47677	7" x 10"	AL



47713	7" x 10"	SS
47721	7" x 10"	PL
47722	7" x 10"	AL



47731	10" x 7"	SS
47733	10" x 7"	PL
47734	10" x 7"	AL



88530	7" x 7"	SS
44608	6" x 6"	Acrylic
25191	7" x 10"	PL
42768	7" x 10"	AL

Braille (ADA) Restroom Signs

Brady also offers restroom signs that comply with requirements set under the Americans with Disabilities Act (ADA).

View **page 447** for all Braille Signs.

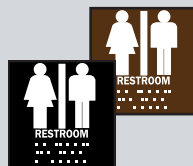

70593	4" x 12"	FB
-------	----------	----



25919	10" x 14"	PL
43495	10" x 14"	AL

Safety Sign Sliders

BradyID.com/s36

Safety Sign Sliders

Brady Safety Sign Sliders help you keep employees and visitors safe with the most current and important messages. The highly visual display ensures that anyone entering the facility or work area is aware of the necessary safety precautions. Custom or stock sliding inserts can easily be added, removed or reordered to update safety and awareness messages quickly and cost-effectively.

Sign Selection Guide

PL - Plastic (B-401)

AL - Aluminum (B-555)

Material Comparison page 408

Sign Legend Index..... page 588

Wall Mount Boards



Catalog #	Description	Material	Sign Capacity	Size	Qty
140747	Single Wall Mount	Plastic	4	36" x 24"	1
140746	Single Wall Mount	Plastic	6	50" x 24"	1
140745	Single Wall Mount	Plastic	8	64" x 24"	1
140736	Single Wall Mount	Plastic	11	74" x 24"	1
140744	Single Wall Mount	Aluminum	4	36" x 24"	1
140743	Single Wall Mount	Aluminum	6	50" x 24"	1
140742	Single Wall Mount	Aluminum	8	64" x 24"	1
140741	Single Wall Mount	Aluminum	11	74" x 24"	1



Safety Signs























3-Sided Free Standing Boards













Catalog #	Description	Material	Sign Capacity	Size	Qty
140740	3-Side Free Standing	Plastic	4	36" x 24"	1
140739	3-Side Free Standing	Plastic	6	50" x 24"	1
140738	3-Side Free Standing	Plastic	8	64" x 24"	1
140737	3-Side Free Standing	Plastic	11	74" x 24"	1



Mandatory Action Sign Sliders



 DUST MASKS ARE REQUIRED AT ALL TIMES	 DUST MASKS ARE REQUIRED IN THIS AREA	 EVERY PERSON HAS THE RESPONSIBILITY AND AUTHORITY TO STOP WORK IN AN UNSAFE SITUATION	 HARD HAT, SAFETY GLASSES AND HEARING PROTECTION MUST BE WORN	 HARD HATS AND SAFETY GLASSES WITH CLEAR LENSES AND SIDE SHIELDS MUST BE WORN AT ALL TIMES
140777 6" x 23.875" PL 140822 6" x 23.875" AL	140803 6" x 23.875" PL 140823 6" x 23.875" AL	140751 6" x 23.875" PL 140797 6" x 23.875" AL	140757 6" x 23.875" PL 140801 6" x 23.875" AL	140753 6" x 23.875" PL 140795 6" x 23.875" AL
 HARD HATS MUST BE WORN AT ALL TIMES	 HARD HATS MUST BE WORN IN THIS AREA	 HEARING PROTECTION AND SAFETY GLASSES MUST BE WORN	 HEARING PROTECTION MUST BE WORN AT ALL TIMES	 HEARING PROTECTION MUST BE WORN IN THIS AREA
140783 6" x 23.875" PL 140828 6" x 23.875" AL	140782 6" x 23.875" PL 140829 6" x 23.875" AL	140784 6" x 23.875" PL 140796 6" x 23.875" AL	140752 6" x 23.875" PL 140830 6" x 23.875" AL	140802 6" x 23.875" PL 140831 6" x 23.875" AL
 PROPER HAND PROTECTION IS REQUIRED FOR ALL TASKS EXCEPT WHEN WORKING WITH ROTATING EQUIPMENT	 REPORT ALL INJURIES OR UNSAFE CONDITIONS IMMEDIATELY	 RESPIRATORS ARE REQUIRED AT ALL TIMES	 RESPIRATORS ARE REQUIRED IN THIS AREA	 SAFETY FOOTWEAR IS REQUIRED AT ALL TIMES
140750 6" x 23.875" PL 140798 6" x 23.875" AL	140773 6" x 23.875" PL 140819 6" x 23.875" AL	140774 6" x 23.875" PL 140820 6" x 23.875" AL	140776 6" x 23.875" PL 140821 6" x 23.875" AL	140780 6" x 23.875" PL 140826 6" x 23.875" AL
 SAFETY FOOTWEAR IS REQUIRED IN THIS AREA	 SAFETY GLASSES MUST BE WORN AT ALL TIMES	 SAFETY GLASSES MUST BE WORN IN THIS AREA	 SAFETY GLASSES WITH CLEAR LENSES AND SIDE SHIELDS MUST BE WORN AT ALL TIMES	 SAFETY GLOVES ARE REQUIRED AT ALL TIMES
140781 6" x 23.875" PL 140827 6" x 23.875" AL	140785 6" x 23.875" PL 140763 6" x 23.875" AL	140786 6" x 23.875" PL 140832 6" x 23.875" AL	140748 6" x 23.875" PL 140800 6" x 23.875" AL	140778 6" x 23.875" PL 140824 6" x 23.875" AL
 SAFETY GLOVES ARE REQUIRED IN THIS AREA	 "STEEL-TOE" SAFETY FOOTWEAR IS REQUIRED IN ALL AREAS WHEN OUTSIDE OF DESIGNATED WALKWAYS			
140779 6" x 23.875" PL 140825 6" x 23.875" AL	140749 6" x 23.875" PL 140799 6" x 23.875" AL			

Prohibition Sign Sliders

 NO CELL PHONES / NO TEXTING WHILE DRIVING	 NO CONCEALED WEAPONS ALLOWED ON COMPANY GROUNDS	 NO FIREARMS ALLOWED ON COMPANY GROUNDS	 NO FOOD OR BEVERAGE ALLOWED	 NO FOOD OR BEVERAGE ALLOWED IN THIS AREA
140758 6" x 23.875" PL 140791 6" x 23.875" AL	140767 6" x 23.875" PL 140812 6" x 23.875" AL	140768 6" x 23.875" PL 140813 6" x 23.875" AL	140769 6" x 23.875" PL 140814 6" x 23.875" AL	140804 6" x 23.875" PL 140815 6" x 23.875" AL
 NO HIGH HEEL, OPEN TOE, OPEN HEEL OR TRENCHING SHOES, SANDALS, SHORTS OR SLEEVELESS SHIRTS	 PHOTOGRAPHY NOT ALLOWED UNLESS AUTHORIZED	 SHORTS, SLEEVELESS SHIRTS AND UNLACED SHIRTS ARE PROHIBITED	 THIS IS A SMOKE FREE WORKPLACE	 USE OF CELLULAR PHONES PROHIBITED
140759 6" x 23.875" PL 140790 6" x 23.875" AL	140760 6" x 23.875" PL 140789 6" x 23.875" AL	140761 6" x 23.875" PL 140788 6" x 23.875" AL	140772 6" x 23.875" PL 140818 6" x 23.875" AL	140771 6" x 23.875" PL 140817 6" x 23.875" AL

Caution Sign Sliders

 BE AWARE OF MOVING EQUIPMENT	 BE AWARE OF OVERHEAD CRANES	 BE AWARE OF OVERHEAD CRANES AND AVOID SUSPENDED LOADS	 STAY ALERT AND YIELD TO FORKLIFT TRAFFIC	 WATCH FOR MOWING VEHICLES
140765 6" x 23.875" PL 140810 6" x 23.875" AL	140754 6" x 23.875" PL B-401 140811 6" x 23.875" PL B-555	140766 6" x 23.875" PL 140794 6" x 23.875" AL	140755 6" x 23.875" PL 140793 6" x 23.875" AL	140770 6" x 23.875" PL 140816 6" x 23.875" AL

 MANDATORY ACTION PROHIBITION	 CAUTION ENVIRONMENTAL
140762 3" x 23.875" PL 140787 3" x 23.875" AL	

(Blank)
140807 3" x 23.875" PL 140808 4" x 23.875" PL 140805 3" x 23.875" AL 140806 4" x 23.875" AL

Environmental Sign Sliders

 HELP KEEP OUR FACILITY CLEAN	 SEGREGATE WASTE AND RECYCLE IN APPROPRIATE CONTAINERS
140764 6" x 23.875" PL 140809 6" x 23.875" AL	140756 6" x 23.875" PL 140792 6" x 23.875" AL

Safety Banners

BradyID.com/s36

Safety Banners

Brady safety banners promote and motivate employees on the importance of workplace safety and preparedness. These banners are large, highly visible and can be hung throughout your facility. Made of a heavy-duty polyethylene, Brady safety banners can withstand industrial work environments.

Banner Material

Banners are constructed of heavy-duty vinyl and are for indoor use only.

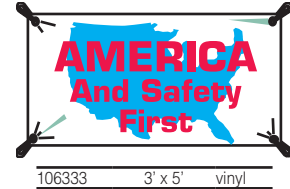
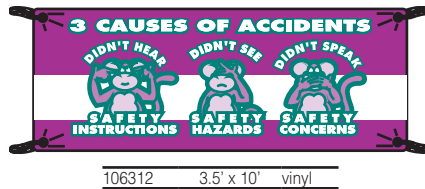
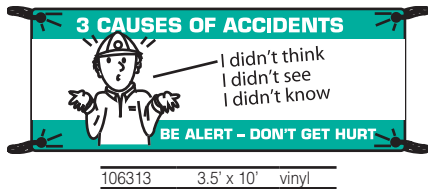

Safety Signs

Safety Banners (continued)



106327 3.5' x 10' vinyl



106328 3.5' x 10' vinyl



56970 3' x 5' vinyl

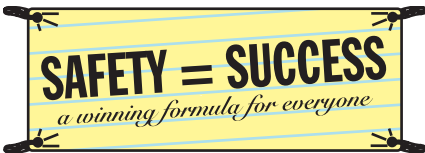

106298 3.5' x 10' vinyl



106332 3' x 5' vinyl



106329 3' x 5' vinyl



106291 3.5' x 10' vinyl



106292 3.5' x 10' vinyl



106294 3.5' x 10' vinyl



106295 3.5' x 10' vinyl



106330 3' x 5' vinyl



50909 3.5' x 10' vinyl



50907 3.5' x 10' vinyl



106296 3.5' x 10' vinyl



106331 3' x 5' vinyl
106297 3.5' x 10' vinyl



106303 3.5' x 10' vinyl



106299 3.5' x 10' vinyl



106300 3.5' x 10' vinyl

Safety Banners

BradyID.com/s36

Safety Banners (continued)

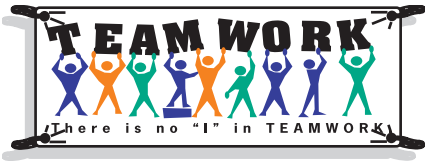

50900 3.5' x 10' vinyl



50911 3.5' x 10' vinyl

Banner Material

Banners are constructed of heavy-duty vinyl and are for indoor use only.



106304 3.5' x 10' vinyl



106305 3.5' x 10' vinyl



106306 3.5' x 10' vinyl



56968 3' x 5' vinyl



50902 3.5' x 10' vinyl



50912 3.5' x 10' vinyl



50901 3.5' x 10' vinyl



106308 3.5' x 10' vinyl



106307 3.5' x 10' vinyl



106310 3.5' x 10' vinyl



106311 3.5' x 10' vinyl



50903 3.5' x 10' vinyl

Safety Signs



Safety Posters

Brady safety banners are concise, easy to understand safety posters that are designed to provide continued reinforcement of your ongoing safety programs.

Banner Material

Posters are laminated on both sides and are recommended for indoor use only.

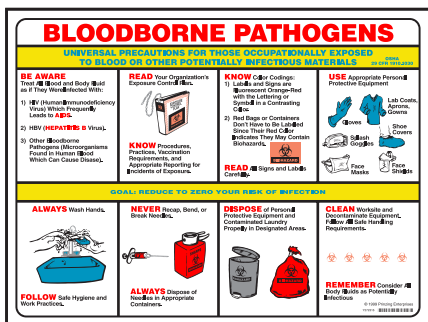

PS125E English 18' x 24' Laminated
PS125S Spanish 18' x 24' Laminated

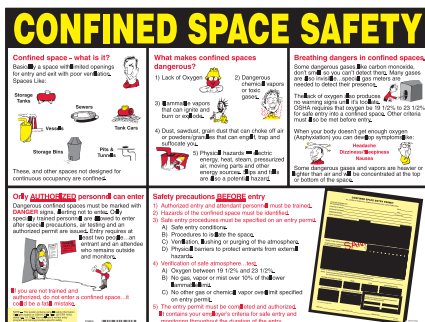

CSP English 18' x 24' Laminated



PS128E English 18' x 24' Laminated

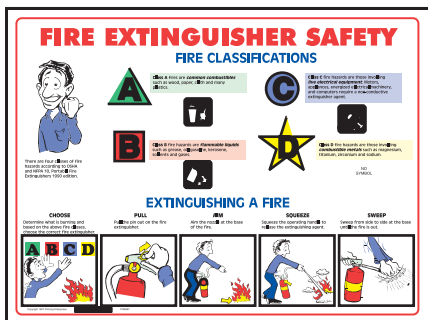

FEFP English 18' x 24' Laminated



FLSP English 18' x 24' Laminated

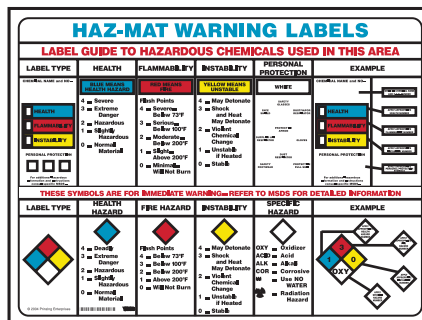

PS135E English 18' x 24' Laminated



53202 English 22' x 26' Laminated
53203 Spanish 22' x 26' Laminated



BLSP English 18' x 24' Laminated

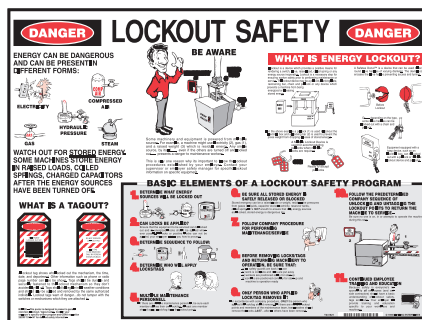

LOSP8 English 18' x 24' Laminated
LOSP8SP Spanish 18' x 24' Laminated

Safety Posters

BradyID.com/s36

Safety Posters (continued)



MSSP English 18" x 24" Laminated



PS127E English 18" x 24" Laminated

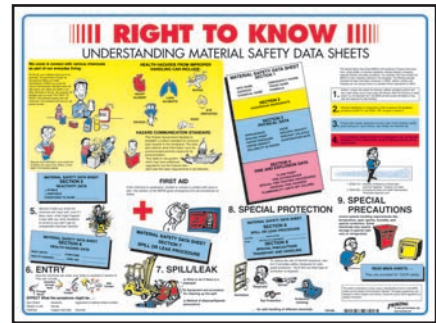

PS139E English 18" x 24" Laminated
PS139S Spanish 18" x 24" Laminated



OSHA Safety Poster

- Poster provides all the postings, notices and information that the government requires general industry employers to have in their facility
- All-on-one format saves wall space
- Poster comes with a first aid at-a-glance sheet and a good faith safety compliance certificate

Catalog #	Description	Size	Qty.
106434	OSHA Safety Poster	25.5" x 39.5"	1 set

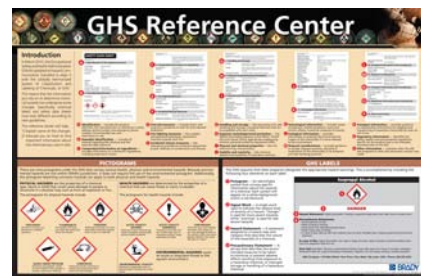

GHS Reference Center Poster

- This all-inclusive, large format poster gets worker attention and combines many of the most important changes into one easy-to-read format
- Includes detailed information on:
 - Safety Data Sheet (SDS) format
 - GHS-formatted label elements
 - GHS Hazard Pictograms

Catalog #	Description	Size	Qty.
133209	GHS Reference Center Poster	25.5" x 39.5"	1 each



GHS Intro Poster Pack

- Set of 3 informational posters puts critical GHS information in different parts of your facility and promotes employee understanding
- Posters outline:
 - An overview of the Globally Harmonized System of Classification and Labeling of Chemicals
 - Information on SDS format and outline
 - Information on GHS-formatted label elements

Catalog #	Description	Size	Qty.
133207	GHS Intro Posters	17" x 22"	1 set of 3

Safety Signs

Sign Holders

Clear poster holder allows you to store different posters and to rotate the display according to your safety program.

Catalog #	Description	Size	Color	Qty.
SH1824	Sign Holder	18" x 24"	Clear	1



Safety Slogan Signs

Brady safety awareness signs will promote safety and teamwork in your facility while helping you comply with OSHA regulations for accident prevention. They are highly noticeable and available in a wide array of sizes and materials and available for almost any application.

Sign Selection Guide

- FB** - Premium fiberglass (B-120)
- SS** - Self-sticking polyester (B-302)
- PL** - Plastic (B-401)
- AL** - Aluminum (B-555)

Material Comparison page 408
Sign Legend Index..... page 588



72605	14" x 20"	FB
88791	10" x 14"	SS
25295	7" x 10"	PL



88842	7" x 10"	SS
88843	10" x 14"	SS
25315	7" x 10"	PL
25316	10" x 14"	PL
42893	10" x 14"	AL



25297	7" x 10"	PL
25298	10" x 14"	PL
88806	7" x 10"	SS
42874	7" x 10"	AL



88810	7" x 10"	SS
88811	10" x 14"	SS
25299	7" x 10"	PL
25300	10" x 14"	PL
42876	7" x 10"	AL

Regulations

Safety Instruction Signs 1910.145(c)(3)

Safety instruction signs shall be used where there is a need for general instructions and suggestions relative to safety measures.



72936	14" x 20"	FB
88814	7" x 10"	SS
88815	10" x 14"	SS
25301	7" x 10"	PL
25302	10" x 14"	PL
42879	10" x 14"	AL



88830	7" x 10"	SS
88831	10" x 14"	SS
25307	7" x 10"	PL



25688	7" x 10"	PL
25689	10" x 14"	PL
43265	7" x 10"	AL



69755	10" x 14"	FB
88834	7" x 10"	SS
88835	10" x 14"	SS
25309	7" x 10"	PL
25310	10" x 14"	PL
42887	10" x 14"	AL



69173	10" x 14"	FB
88838	7" x 10"	SS
88839	10" x 14"	SS
25311	7" x 10"	PL
25312	10" x 14"	PL
42888	7" x 10"	AL
42889	10" x 14"	AL



88840	7" x 10"	SS
25313	7" x 10"	PL
25314	10" x 14"	PL
42891	10" x 14"	AL



69333	10" x 14"	FB
88846	7" x 10"	SS
25317	7" x 10"	PL
42895	10" x 14"	AL



69352	10" x 14"	FB
88848	7" x 10"	SS
88849	10" x 14"	SS
25319	7" x 10"	PL
25320	10" x 14"	PL
42896	7" x 10"	AL
42897	10" x 14"	AL



87682	7" x 10"	FB
35478	10" x 14"	SS
35480	10" x 14"	PL



73471	7" x 10"	FB
-------	----------	----



69464	10" x 14"	FB
88852	7" x 10"	SS
88853	10" x 14"	SS
25323	7" x 10"	PL
25324	10" x 14"	PL
42900	7" x 10"	AL
42901	10" x 14"	AL



88860	7" x 10"	SS
88861	10" x 14"	SS
42902	7" x 10"	AL
42903	10" x 14"	AL
70205	10" x 14"	FB
25325	7" x 10"	PL
25326	10" x 14"	PL



73449	10" x 14"	FB
88864	7" x 10"	SS
88865	10" x 14"	SS
25327	7" x 10"	PL
25328	10" x 14"	PL
42904	7" x 10"	AL
42905	10" x 14"	AL



70293	10" x 14"	FB
88866	7" x 10"	SS
25329	7" x 10"	PL
25330	10" x 14"	PL
42906	7" x 10"	AL
42907	10" x 14"	AL



73464	10" x 14"	FB
88870	7" x 10"	SS
88871	10" x 14"	SS
25331	7" x 10"	PL
25332	10" x 14"	PL
42909	10" x 14"	AL



70462	10" x 14"	FB
88872	7" x 10"	SS
88873	10" x 14"	SS
25333	7" x 10"	PL
25334	10" x 14"	PL
42910	7" x 10"	AL
42911	10" x 14"	AL



69414	10" x 14"	FB
88874	7" x 10"	SS
88875	10" x 14"	SS
25335	7" x 10"	PL
25336	10" x 14"	PL
42912	7" x 10"	AL
42913	10" x 14"	AL



25337	7" x 10"	PL
25338	10" x 14"	PL
42914	7" x 10"	AL
42915	10" x 14"	AL
88876	7" x 10"	SS
88877	10" x 14"	SS

Safety Slogan Signs / Scoreboards

BradyID.com/s36

Safety Slogan Signs (continued)



69515	10" x 14"	FB
88878	7" x 10"	SS
88879	10" x 14"	SS
25339	7" x 10"	PL
25340	10" x 14"	PL
42916	7" x 10"	AL
42917	10" x 14"	AL



88880	7" x 10"	SS
25341	7" x 10"	PL
25342	10" x 14"	PL
42918	7" x 10"	AL
88881	10" x 14"	SSV



70578	10" x 14"	FB
25343	7" x 10"	PL
25344	10" x 14"	PL
42920	7" x 10"	AL
42921	10" x 14"	AL



25346	10" x 14"	PL
42923	10" x 14"	AL

Sign Selection Guide

FB - Premium fiberglass (B-120)
SS - Self-sticking polyester (B-302)
PL - Plastic (B-401)
AL - Aluminum (B-555)
BGSS - BradyGlo™ self-stick polyester (B-324)
BGPL - BradyGlo™ plastic (B-347)

Material Comparison page 408
Sign Legend Index..... page 588



69785	14" x 20"	FB
88898	7" x 10"	SS
88899	10" x 14"	SS
25347	7" x 10"	PL
42924	7" x 10"	AL



70518	10" x 14"	FB
88905	7" x 10"	SS
25348	7" x 10"	PL
25349	10" x 14"	PL
42925	7" x 10"	AL
42926	10" x 14"	AL



73423	20" x 28"	FB
-------	-----------	----



90786	5" x 14"	BGPL
-------	----------	------



76093	10" x 14"	FB
88908	7" x 10"	SS
88909	10" x 14"	SS
25350	7" x 10"	PL
25351	10" x 14"	PL
42928	10" x 14"	AL



88910	7" x 10"	SS
88911	10" x 14"	SS
42929	7" x 10"	AL

Scoreboards Signs

Brady safety scoreboards help you track your facility's safety performance, and motivate your employees to maintain safe work practices. They are made of durable 20 gauge steel or polyethylene.



Magnetic Numbers

- 1.5" high numbers
- Includes 15 each of 0-3; 8 each of 4-9

Catalog #	Size	Qty.
57624	1.5"	108



SM793E 20" x 14" Polyethylene

Safety Signs

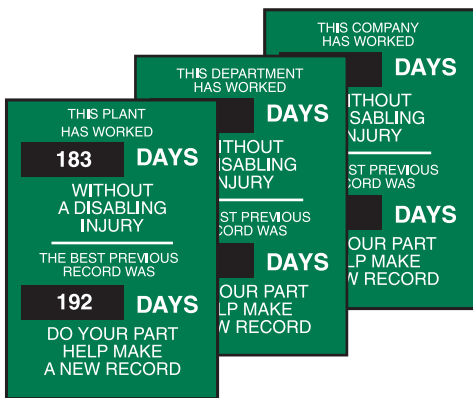



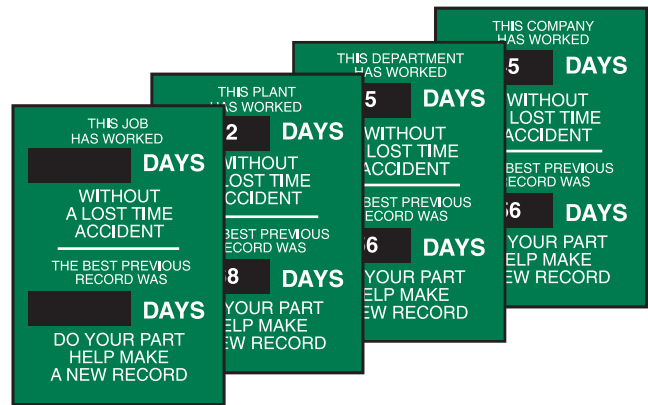









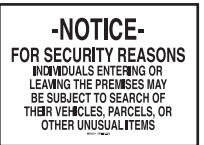

















49111	28" x 20"	This plant...without a disabling injury	Steel
49113	28" x 20"	This company...without a disabling injury	Steel
49112	28" x 20"	This department...without a disabling injury	Steel



49114	28" x 20"	This job...without a lost time accident	Steel
49115	28" x 20"	This plant...without a lost time accident	Steel
49117	28" x 20"	This company...without a lost time accident	Steel
49116	28" x 20"	This department...without a lost time accident	Steel

Security Signs

Brady security signs deter unwanted visitors and keep your facility safe with a variety of messages, including: video surveillance, restricted areas, and "no trespassing" notices.

 <p>NOTICE ALL EMPLOYEES AND VISITORS MUST WEAR IDENTIFICATION BADGES</p>	 <p>NOTICE ALL VEHICLES ENTERING OR LEAVING SUBJECT TO SEARCH</p>	 <p>-NOTICE- FOR SECURITY REASONS INDIVIDUALS ENTERING OR LEAVING THE PREMISES MAY BE SUBJECT TO SEARCH OF THEIR VEHICLES, PARCELS, OR OTHER UNUSUAL ITEMS</p>	 <p>NOTICE NO ALCOHOLIC BEVERAGES OR DRUGS PERMITTED ON COMPANY PROPERTY THIS INCLUDES THE PARKING LOT</p>	 <p>NOTICE NO PHONES, CAMERAS OR OTHER ELECTRONIC DEVICES PERMITTED</p>	 <p>NOTICE THIS AREA IS UNDER 24 HOUR TV SURVEILLANCE TRESPASSERS WILL BE PROSECUTED</p>
129407 7" x 10" SS 129410 10" x 14" SS 129406 7" x 10" PL 129409 10" x 14" PL 129405 7" x 10" AL 129408 10" x 14" AL	95418 10" x 14" PL	95462 14" x 20" FB	123595 7" x 10" SS 123598 10" x 14" SS 123594 7" x 10" PL 123597 10" x 14" PL 123593 7" x 10" AL 123596 10" x 14" AL	132047 7" x 10" FB 132048 10" x 14" FB 132045 7" x 10" SS 132046 10" x 14" SS 132043 7" x 10" PL 132044 10" x 14" PL 132041 7" x 10" AL 132042 10" x 14" AL	123601 10" x 7" SS 123604 14" x 10" SS 123600 10" x 7" PL 123603 14" x 10" PL 123599 10" x 7" AL 123602 14" x 10" AL
 <p>NOTICE VENDORS AND VISITORS MUST REGISTER AT MAIN OFFICE</p>	 <p>RESTRICTED AREA ALL VISITORS MUST GET PASS AT OFFICE</p>	 <p>RESTRICTED AREA AUTHORIZED PERSONNEL ONLY</p>	 <p>RESTRICTED AREA DO NOT ENTER</p>	 <p>RESTRICTED AREA DO NOT ENTER AUTHORIZED PERSONNEL ONLY</p>	 <p>RESTRICTED AREA ENTRANCE FOR EMPLOYEES ONLY</p>
123589 7" x 10" SS 123592 10" x 14" SS 123588 7" x 10" PL 123591 10" x 14" PL 123587 7" x 10" AL 123590 10" x 14" AL	122865 7" x 10" FB 122727 10" x 14" FB 122658 7" x 10" SS 122581 10" x 14" SS 122531 7" x 10" PL 95465 10" x 14" PL 122422 7" x 10" AL 122356 10" x 14" AL	95466 10" x 14" PL	95467 10" x 14" PL	122869 7" x 10" FB 122730 10" x 14" FB 122661 7" x 10" SS 122584 10" x 14" SS 122534 7" x 10" PL 95468 10" x 14" PL 122425 7" x 10" AL 122359 10" x 14" AL	95469 10" x 14" PL
 <p>RESTRICTED AREA NO ADMITTANCE EMPLOYEES ONLY</p>	 <p>RESTRICTED AREA NO ADMITTANCE WITHOUT AUTHORIZATION</p>	 <p>RESTRICTED AREA NO ENTRY UNLESS AUTHORIZED</p>	 <p>RESTRICTED AREA NO TRESPASSING</p>	 <p>RESTRICTED AREA NO TRESPASSING UNDER PENALTY OF THE LAW</p>	 <p>RESTRICTED AREA NOT AN ENTRANCE</p>
122875 7" x 10" FB 122736 10" x 14" FB 122671 7" x 10" SS 122594 10" x 14" SS 122540 7" x 10" PL 95470 10" x 14" PL 122431 7" x 10" AL 122363 10" x 14" AL	95471 10" x 14" PL	95472 10" x 14" PL	95473 10" x 14" PL	95474 10" x 14" PL	95475 10" x 14" PL
 <p>RESTRICTED AREA ONLY AUTHORIZED PERSONS TO ENTER THIS AREA</p>	 <p>RESTRICTED AREA PRIVATE NO TRESPASSING</p>	 <p>RESTRICTED AREA SECURITY ALARM WILL SOUND IF DOOR IS OPENED</p>	 <p>RESTRICTED AREA THIS PROPERTY PROTECTED BY ELECTRONIC SURVEILLANCE</p>	 <p>RESTRICTED AREA MONITORED BY VIDEO CAMERA</p>	 <p>SECURITY NOTICE ALL VISITORS MUST REPORT TO SECURITY</p>
95476 10" x 14" PL	95477 10" x 14" PL	95478 10" x 14" PL	95479 10" x 14" PL	123528 7" x 10" SS 123531 10" x 14" SS 123527 7" x 10" PL 123530 10" x 14" PL 123526 7" x 10" AL 123529 10" x 14" AL	122866 7" x 10" FB 122728 10" x 14" FB 122659 7" x 10" SS 122582 10" x 14" SS 122532 7" x 10" PL 122480 10" x 14" PL 95481 14" x 20" PL 122423 7" x 10" AL 122357 10" x 14" AL
 <p>SECURITY NOTICE NO ADMITTANCE BEYOND THIS POINT CHECK WITH GUARD</p>	 <p>SECURITY NOTICE NO ADMITTANCE BEYOND THIS POINT CHECK WITH SECURITY</p>	 <p>SECURITY NOTICE NO ADMITTANCE WITHOUT SECURITY PASS</p>	 <p>SECURITY NOTICE PARKING PERMITS ARE REQUIRED IN THIS AREA UNAUTHORIZED VEHICLES WILL BE TOWED</p>	 <p>SECURITY NOTICE PRIVATE PROPERTY KEEP OUT</p>	 <p>SECURITY NOTICE PRIVATE PROPERTY TRESPASSERS WILL BE PROSECUTED</p>
95483 14" x 20" PL	95484 14" x 20" PL	95485 14" x 20" PL	95486 14" x 20" PL	95487 14" x 20" PL	95488 14" x 20" PL

Security Signs

BradyID.com/s36

Security Signs (continued)

SECURITY NOTICE
RESTRICTED AREA
AUTHORIZED
PERSONNEL ONLY

95489 14" x 20" PL

SECURITY NOTICE
SECURITY BADGES
MUST BE WORN
AT ALL TIMES

122886 7" x 10" FB
122746 10" x 14" FB
122682 7" x 10" SS
122604 10" x 14" SS
122550 7" x 10" PL
122486 10" x 14" PL
95491 14" x 20" PL
122441 7" x 10" AL
122372 10" x 14" AL

SECURITY NOTICE
THESE PREMISES
ARE ALARMED

95492 14" x 20" PL

SECURITY NOTICE
THIS DOOR
IS ALARMED

95493 14" x 20" PL

Sign Selection Guide

- FB - Premium fiberglass (B-120)
- SS - Self-sticking polyester (B-302)
- PL - Plastic (B-401)
- AL - Aluminum (B-555)
- BGSS - BradyGlo™ self-stick polyester (B-324)
- BGPL - BradyGlo™ plastic (B-347)

Material Comparison page 408
Sign Legend Index..... page 588

SECURITY NOTICE
THIS PROPERTY IS
PROTECTED BY
ELECTRONIC
SURVEILLANCE

122888 7" x 10" FB
122748 10" x 14" FB
122684 7" x 10" SS
122606 10" x 14" SS
122552 7" x 10" PL
122487 10" x 14" PL
95494 14" x 20" PL
122443 7" x 10" AL
122374 10" x 14" AL

SECURITY NOTICE
UNAUTHORIZED
VEHICLES
PROHIBITED

95495 14" x 20" PL

SECURITY NOTICE
VIDEO SURVEILLANCE
IN USE ON THESE
PREMISES

122889 7" x 10" FB
122749 10" x 14" FB
122685 7" x 10" SS
122607 10" x 14" SS
122553 7" x 10" PL
122488 10" x 14" PL
95496 14" x 20" PL
122444 7" x 10" AL
122375 10" x 14" AL

WARNING
STEALING WILL
LEAD TO ARREST
AND PROSECUTION

95426 10" x 14" PL

WARNING
THIS AREA
PATROLLED BY
ATTACK DOGS

95427 10" x 14" PL

WARNING
THIS PROPERTY
PROTECTED BY
SECURITY PATROL

95428 10" x 14" PL

ALL UNAUTHORIZED
VEHICLES WILL BE
TOWED AWAY AT
VEHICLES OWNER'S
EXPENSE AND RISK

95461 14" x 20" FB

APPROACH
SLOWLY
GATE WILL
OPEN

95459 14" x 20" FB

CAMERAS
NOT ALLOWED

132025 7" x 10" FB
132026 10" x 14" FB
132023 7" x 10" SS
132024 10" x 14" SS
132022 7" x 10" PL
132020 7" x 10" AL
132021 10" x 14" AL

CAMERAS
NOT ALLOWED

122867 7" x 10" FB
122729 10" x 14" FB
122660 7" x 10" SS
122583 10" x 14" SS
95411 10" x 14" PL
122424 7" x 10" AL
122358 10" x 14" AL

DAMAGING OR
DEFACING
COMPANY
PROPERTY WILL
RESULT IN
DISCIPLINARY ACTION

95412 10" x 14" PL

DO NOT
ENTER

40782 10" x 14" AL

EMPLOYEES
ONLY

95431 10" x 14" PL

KEEP OUT
AUTHORIZED
PERSONNEL
ONLY

95432 10" x 14" PL

NO
ADMITTANCE
AUTHORIZED
PERSONS
ONLY

95458 14" x 20" FB

NO ADMITTANCE
EMPLOYEES ONLY

95433 10" x 14" PL

NO ADMITTANCE
EXCEPT TO
EMPLOYEES ON
DUTY

95434 10" x 14" PL

NO
ADMITTANCE
RING BELL FOR
SERVICE

95435 10" x 14" PL

NO ADMITTANCE
WITHOUT
AUTHORIZATION

95436 10" x 14" PL

NO BICYCLES
SKATEBOARDS
ROLLERBLADES

122876 7" x 10" FB
122737 10" x 14" FB
95463 14" x 20" FB
122672 7" x 10" SS
122595 10" x 14" SS
122541 7" x 10" PL
95413 10" x 14" PL
122432 7" x 10" AL
122364 10" x 14" AL

NO DUMPING
VIOLATORS
WILL BE
PROSECUTED

122879 7" x 10" FB
122740 10" x 14" FB
122675 7" x 10" SS
122598 10" x 14" SS
122544 7" x 10" PL
95414 10" x 14" PL
122435 7" x 10" AL
122367 10" x 14" AL



Design custom security signs online
BradyID.com/customsigns

Safety Signs

Security Signs (continued)



122880	7" x 10"	FB
122741	10" x 14"	FB
122676	7" x 10"	SS
122599	10" x 14"	SS
122545	7" x 10"	PL
95415	10" x 14"	PL
122436	7" x 10"	AL
122368	10" x 14"	AL



95416	10" x 14"	PL
-------	-----------	----



90498	14" x 20"	FB
-------	-----------	----



95417	10" x 14"	PL
-------	-----------	----



123485	10" x 7"	SS
123488	14" x 10"	SS
123484	10" x 7"	PL
123487	14" x 10"	PL
123483	10" x 7"	AL
123486	14" x 10"	AL



129413	7" x 10"	SS
129416	10" x 14"	SS
129412	7" x 10"	PL
129415	10" x 14"	PL
129411	7" x 10"	AL
129414	10" x 14"	AL



95457	14" x 20"	FB
-------	-----------	----



90499	14" x 20"	FB
-------	-----------	----



95456	14" x 20"	FB
-------	-----------	----



123522	10" x 7"	SS
123525	14" x 10"	SS
123521	10" x 7"	PL
123524	14" x 10"	PL
123520	10" x 7"	AL
123523	14" x 10"	AL



122881	7" x 10"	FB
122742	10" x 14"	FB
95452	24" x 18"	FB
122677	7" x 10"	SS
122600	10" x 14"	SS
122546	7" x 10"	PL
95429	20" x 14"	PL
122437	7" x 10"	AL
122369	10" x 14"	AL



95420	10" x 14"	PL
-------	-----------	----



95453	24" x 18"	FB
95430	20" x 14"	PL



122885	7" x 10"	FB
122745	10" x 14"	FB
122681	7" x 10"	SS
122603	10" x 14"	SS
122549	7" x 10"	PL
95421	10" x 14"	PL
122440	7" x 10"	AL
122371	10" x 14"	AL



95438	10" x 14"	PL
-------	-----------	----



95437	10" x 14"	PL
-------	-----------	----



129419	7" x 10"	SS
129422	10" x 14"	SS
129418	7" x 10"	PL
129421	10" x 14"	PL
129417	7" x 10"	AL
129420	10" x 14"	AL



123482	24" x 36"	SS
123480	24" x 36"	AL



95027	11" x 11"	PL
-------	-----------	----



122887	7" x 10"	FB
122747	10" x 14"	FB
122683	7" x 10"	SS
122605	10" x 14"	SS
122551	7" x 10"	PL
95424	10" x 14"	PL
122442	7" x 10"	AL
122373	10" x 14"	AL



95423	10" x 14"	PL
-------	-----------	----



95455	14" x 20"	FB
-------	-----------	----



123534	10" x 7"	SS
123537	14" x 10"	SS
123533	10" x 7"	PL
123536	14" x 10"	PL
123532	10" x 7"	AL
123535	14" x 10"	AL



95451	24" x 18"	FB
-------	-----------	----

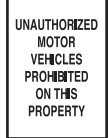

95450	24" x 18"	FB
-------	-----------	----

Homeland Security Signs

Security signs with easily changeable panels to indicate the threat level so everyone is prepared and alerted.



103644 30" x 24" Steel



132451 24" x 24" Aluminum



132449 24" x 24" Aluminum



Temporary Signs

BradyID.com/s36

Temporary Signs

Brady temporary signs are constructed to communicate short-term messages and are ideal for work area safety during short-term construction projects. These signs are also helpful for posting parking restrictions during special events or during parking lot repaving.

Sign Selection Guide

TMP- A lightweight corrugated plastic sign material for indoor use or secured outdoor use. (B-836)

Material Guide..... page 408
Sign Legend Index..... page 588

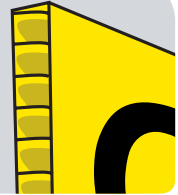

78037 18" x 24" TMP	78035 18" x 24" TMP	78036 18" x 24" TMP	78031 18" x 24" TMP	78033 18" x 24" TMP	78055 18" x 24" TMP
78002 18" x 24" TMP	78014 18" x 24" TMP	78003 18" x 24" TMP	78011 18" x 24" TMP	78004 18" x 24" TMP	78013 18" x 24" TMP
78009 18" x 24" TMP	78015 18" x 24" TMP	78007 18" x 24" TMP	78016 18" x 24" TMP	78010 18" x 24" TMP	78018 18" x 24" TMP
78019 18" x 24" TMP	78000 18" x 24" TMP	45431 5' x 7" TMP	78047 18" x 12" TMP	78049 18" x 12" TMP	

Safety Signs



Design custom signs online

BradyID.com/customsigns

ToughWash Harsh Washdown Signs

Brady ToughWash Metal-Detectable Polypropylene (B-869) signs feature in-molded and protected graphics for use in harsh environments in the food and beverage processing industry.

- Sign material is detectable by commercially available metal detectors in order to protect food safety
- Durable plastic-encapsulated material withstands harsh washdown environments with temperatures up to 175° F (80° C) and pressure up to 1,500 PSI

Sign Selection Guide

ToughWash Metal-Detectable Polypropylene. (B-869)

Material Guide..... page 408
Sign Legend Index.... page 588



Durable 0.16 in. thick sign with encapsulated graphics

145736 7" x 10" B-869 145737 10" x 14" B-869	145754 7" x 10" B-869 145755 10" x 14" B-869	145758 7" x 10" B-869 145759 10" x 14" B-869	145760 7" x 10" B-869 145761 10" x 14" B-869	145746 7" x 10" B-869 145747 10" x 14" B-869	145756 7" x 10" B-869 145757 10" x 14" B-869
145732 7" x 10" B-869 145733 10" x 14" B-869	145734 7" x 10" B-869 145735 10" x 14" B-869	145744 7" x 10" B-869 145745 10" x 14" B-869	145750 7" x 10" B-869 145751 10" x 14" B-869	145762 7" x 10" B-869 145763 10" x 14" B-869	145764 7" x 10" B-869 145765 10" x 14" B-869
145752 7" x 10" B-869 145753 10" x 14" B-869	145748 7" x 10" B-869 145749 10" x 14" B-869	145738 7" x 10" B-869 145739 10" x 14" B-869			



Metal Detectable Cable Ties

- Use these metal detectable ties with ToughWash Metal Detectable Signs as a metal-detectable solution in harsh washdown environments
- These ties are capable of being detected by commercially available metal detectors
- Won't compromise your food safety

Catalog #	Description	Size	Qty.
145588	Metal Detectable Cable Ties	7 in.	10/pk
145589	Metal Detectable Cable Ties	7 in.	100/pk



Parking Signs

BradyID.com/s36

























Parking Signs

Parking signs allow you to clearly identify areas of your facility where parking is available or restricted. These signs are available in a range of sizes and materials and suitable for outdoor lots or indoor structures. They also can be customized to meet your specific parking identification needs.

Sign Selection Guide

- FB** - Premium fiberglass (B-120)
- SS** - Self-sticking polyester (B-302)
- PL** - Plastic (B-401)
- AL** - Aluminum (B-555)
- RFAL** - Reflective aluminum (B-959)

Material Guide..... page 408
 Sign Legend Index..... page 588

 <p>70247 10' x 14" FB 25823 10' x 14" PL 43400 10' x 14" AL</p>	 <p>69133 10' x 14" FB 25825 10' x 14" PL 43402 10' x 14" AL</p>	 <p>75096 14' x 20" FB 25826 10' x 14" PL 43403 10' x 14" AL</p>	 <p>122855 7' x 10" FB 47329 10' x 14" FB 89133 7' x 10" SS 89134 10' x 14" SS 122523 7' x 10" PL 25829 10' x 14" PL 122415 7' x 10" AL 43406 10' x 14" AL</p>	 <p>75103 14' x 20" FB 25860 10' x 14" PL 43437 10' x 14" AL</p>	 <p>25861 10' x 14" PL 43438 10' x 14" AL</p>
 <p>75137 14' x 20" FB 25868 10' x 14" PL 43445 10' x 14" AL</p>	 <p>45474 14' x 20" FB 25874 10' x 14" PL 43451 10' x 14" AL</p>	 <p>129644 18' x 12" SS 129643 18' x 12" PL 129642 18' x 12" AL</p>	 <p>124388 18' x 12" SS 124387 18' x 12" PL 124386 18' x 12" AL</p>	 <p>129563 18' x 12" SS 129562 18' x 12" PL 129561 18' x 12" AL</p>	 <p>129653 18' x 12" SS 129652 18' x 12" PL 129651 18' x 12" AL</p>
 <p>43421 10' x 14" AL</p>	 <p>25846 10' x 14" PL 43423 10' x 14" AL</p>	 <p>80097 18' x 12" RFAL</p>	 <p>129566 18' x 12" SS 129565 18' x 12" PL 129564 18' x 12" AL</p>	 <p>129647 18' x 12" SS 129646 18' x 12" PL 129645 18' x 12" AL</p>	 <p>129656 18' x 12" SS 129655 18' x 12" PL 129654 18' x 12" AL</p>
 <p>124340 18' x 12" SS 124339 18' x 12" PL 124338 18' x 12" AL</p>	 <p>129569 18' x 12" SS 129568 18' x 12" PL 129567 18' x 12" AL</p>	 <p>129650 18' x 12" SS 129649 18' x 12" PL 129648 18' x 12" AL</p>	 <p>129713 18' x 12" SS 129712 18' x 12" PL 129711 18' x 12" AL</p>	 <p>70257 10' x 14" FB 25889 10' x 14" PL 43466 10' x 14" AL</p>	 <p>75086 12' x 18" FB 25847 10' x 14" PL 43424 10' x 14" AL</p>

Traffic Signs

Parking Signs (continued)



129572	18" x 12"	SS
129571	18" x 12"	PL
129570	18" x 12"	AL



129716	18" x 12"	SS
129715	18" x 12"	PL
129714	18" x 12"	AL



124328	18" x 12"	SS
124327	18" x 12"	PL
124326	18" x 12"	AL



129620	18" x 12"	SS
129619	18" x 12"	PL
129618	18" x 12"	AL



129719	18" x 12"	SS
129718	18" x 12"	PL
129717	18" x 12"	AL



129725	18" x 12"	SS
129724	18" x 12"	PL
129723	18" x 12"	AL



75101	12" x 18"	FB
-------	-----------	----



129674	18" x 12"	SS
129673	18" x 12"	PL
129672	18" x 12"	AL



124358	18" x 12"	SS
124357	18" x 12"	PL
124356	18" x 12"	AL



124352	18" x 12"	SS
124351	18" x 12"	PL
124350	18" x 12"	AL



124346	18" x 12"	SS
124345	18" x 12"	PL
124344	18" x 12"	AL



124349	18" x 12"	SS
124348	18" x 12"	PL
124347	18" x 12"	AL



129617	18" x 12"	SS
129616	18" x 12"	PL
129615	18" x 12"	AL



129587	18" x 12"	SS
129586	18" x 12"	PL
129585	18" x 12"	AL



70376	18" x 12"	FB
43427	14" x 10"	AL



129677	18" x 12"	SS
129676	18" x 12"	PL
129675	18" x 12"	AL



69301	10" x 14"	FB
25851	10" x 14"	PL
43428	10" x 14"	AL



129623	18" x 12"	SS
129622	18" x 12"	PL
129621	18" x 12"	AL



70428	10" x 14"	FB
25852	10" x 14"	PL
43429	10" x 14"	AL



129722	18" x 12"	SS
129721	18" x 12"	PL
129720	18" x 12"	AL

Parking Lot Security Signs



69050	10" x 14"	FB
25824	10" x 14"	PL
43401	10" x 14"	AL



75234	10" x 14"	FB
25838	10" x 14"	PL
43415	10" x 14"	AL



25831	10" x 14"	PL
43408	10" x 14"	AL

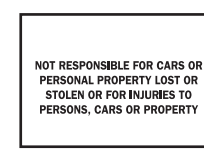

70458	14" x 20"	FB
25859	10" x 14"	PL
43436	10" x 14"	AL



124505	18" x 12"	SS
124504	18" x 12"	PL
124503	18" x 12"	AL

Parking Signs

BradyID.com/s36

Parking Signs (continued)



124576	18" x 18"	PL
124578	24" x 24"	PL
124575	18" x 18"	AL
124577	24" x 24"	AL



71178	7" x 10"	FB
25854	10" x 14"	PL
43431	10" x 14"	AL



25853	7" x 10"	PL
43430	7" x 10"	AL



75071	14" x 20"	FB
25855	10" x 14"	PL
43432	10" x 14"	AL

Sign Selection Guide

- FB - Premium fiberglass (B-120)
- SS - Self-sticking polyester (B-302)
- PL - Plastic (B-401)
- AL - Aluminum (B-555)
- RFAL - Reflective aluminum (B-959)

Material Guide..... page 408
Sign Legend Index..... page 588



75140	18" x 12"	FB
94116	18" x 12"	RFAL
94117	24" x 18"	RFAL



103739	18" x 12"	RFAL
--------	-----------	------



124379	18" x 12"	SS
124378	18" x 12"	PL
124377	18" x 12"	AL



124382	18" x 12"	SS
124381	18" x 12"	PL
124380	18" x 12"	AL



94105	18" x 12"	FB
94120	18" x 12"	RFAL



75141	18" x 12"	FB
94119	18" x 12"	RFAL



113303	18" x 12"	RFAL
--------	-----------	------



113304	18" x 12"	RFAL
--------	-----------	------



113305	18" x 12"	RFAL
--------	-----------	------



75142	18" x 12"	FB
94124	18" x 12"	RFAL



124319	18" x 12"	SS
124318	18" x 12"	PL
124317	18" x 12"	AL



129626	18" x 12"	SS
129625	18" x 12"	PL
129624	18" x 12"	AL



129686	18" x 12"	SS
129685	18" x 12"	PL
129684	18" x 12"	AL



129698	18" x 12"	SS
129697	18" x 12"	PL
129696	18" x 12"	AL



124394	18" x 12"	SS
124393	18" x 12"	PL
124392	18" x 12"	AL



124310	18" x 12"	SS
124309	18" x 12"	PL
124308	18" x 12"	AL



129689	18" x 12"	SS
129688	18" x 12"	PL
129687	18" x 12"	AL



129692	18" x 12"	SS
129691	18" x 12"	PL
129690	18" x 12"	AL



124334	18" x 12"	SS
124333	18" x 12"	PL
124332	18" x 12"	AL



75143	18" x 12"	FB
112626	18" x 12"	RFAL



124325	18" x 12"	SS
124324	18" x 12"	PL
124323	18" x 12"	AL



124322	18" x 12"	SS
124321	18" x 12"	PL
124320	18" x 12"	AL



129734	18" x 12"	SS
129733	18" x 12"	PL
129732	18" x 12"	AL



94127	18" x 12"	RFAL
-------	-----------	------

Parking Signs (continued)



129737	18" x 12"	SS
129736	18" x 12"	PL
129735	18" x 12"	AL



124313	18" x 12"	SS
124312	18" x 12"	PL
124311	18" x 12"	AL



75144	18" x 12"	FB
94130	18" x 12"	RFAL



129695	18" x 12"	SS
129694	18" x 12"	PL
129693	18" x 12"	AL



129746	18" x 12"	SS
129745	18" x 12"	PL
129744	18" x 12"	AL



129749	18" x 12"	SS
129748	18" x 12"	PL
129747	18" x 12"	AL



129632	18" x 12"	SS
129631	18" x 12"	PL
129630	18" x 12"	AL



129629	18" x 12"	SS
129628	18" x 12"	PL
129627	18" x 12"	AL



124337	18" x 12"	SS
124336	18" x 12"	PL
124335	18" x 12"	AL



129635	18" x 12"	SS
129634	18" x 12"	PL
129633	18" x 12"	AL



129638	18" x 12"	SS
129637	18" x 12"	PL
129636	18" x 12"	AL



129740	18" x 12"	SS
129739	18" x 12"	PL
129738	18" x 12"	AL



129701	12" x 18"	SS
129700	12" x 18"	PL
129699	12" x 18"	AL



129659	18" x 12"	SS
129658	18" x 12"	PL
129657	18" x 12"	AL



129743	18" x 12"	SS
129742	18" x 12"	PL
129741	18" x 12"	AL



129683	18" x 12"	SS
129682	18" x 12"	PL
129681	18" x 12"	AL



129707	18" x 12"	SS
129706	18" x 12"	PL
129705	18" x 12"	AL



75166	18" x 12"	FB
-------	-----------	----



129710	18" x 12"	SS
129709	18" x 12"	PL
129708	18" x 12"	AL



25862	10" x 14"	PL
43439	10" x 14"	AL



129596	18" x 12"	SS
129595	18" x 12"	PL
129594	18" x 12"	AL



124391	18" x 12"	SS
124390	18" x 12"	PL
124389	18" x 12"	AL



129662	18" x 12"	SS
129661	18" x 12"	PL
129660	18" x 12"	AL



124307	18" x 12"	SS
124306	18" x 12"	PL
124305	18" x 12"	AL



129641	18" x 12"	SS
129640	18" x 12"	PL
129639	18" x 12"	AL



124367	18" x 12"	SS
124366	18" x 12"	PL
124365	18" x 12"	AL



80077	18" x 12"	RFAL
-------	-----------	------



129602	18" x 12"	SS
129601	18" x 12"	PL
129600	18" x 12"	AL

Handicapped
Parking
Signs on
page 566.



Parking Signs

BradyID.com/s36

Parking Signs (continued)



129608	18" x 12"	SS
129607	18" x 12"	PL
129606	18" x 12"	AL



129731	18" x 12"	SS
129730	18" x 12"	PL
129729	18" x 12"	AL



129728	18" x 12"	SS
129727	18" x 12"	PL
129726	18" x 12"	AL



124370	18" x 12"	SS
124369	18" x 12"	PL
124368	18" x 12"	AL

Sign Selection Guide

- FB** - Premium fiberglass (B-120)
- SS** - Self-sticking polyester (B-302)
- PL** - Plastic (B-401)
- AL** - Aluminum (B-555)
- RFAL** - Reflective aluminum (B-959)

Material Guide..... page 408
Sign Legend Index..... page 588



124331	18" x 12"	SS
124330	18" x 12"	PL
124329	18" x 12"	AL



129605	18" x 12"	SS
129604	18" x 12"	PL
129603	18" x 12"	AL



129611	18" x 12"	SS
129610	18" x 12"	PL
129609	18" x 12"	AL



25865	10" x 14"	PL
43442	10" x 14"	AL



129755	18" x 12"	SS
129754	18" x 12"	PL
129753	18" x 12"	AL



75190	12" x 18"	FB
-------	-----------	----



22253	10" x 14"	PL
40816	7" x 10"	AL
40817	10" x 14"	AL



124385	18" x 12"	SS
124384	18" x 12"	PL
124383	18" x 12"	AL



129665	18" x 12"	SS
129664	18" x 12"	PL
129663	18" x 12"	AL



124343	18" x 12"	SS
124342	18" x 12"	PL
124341	18" x 12"	AL



129752	18" x 12"	SS
129751	18" x 12"	PL
129750	18" x 12"	AL



129668	18" x 12"	SS
129667	18" x 12"	PL
129666	18" x 12"	AL



129704	18" x 12"	SS
129703	18" x 12"	PL
129702	18" x 12"	AL



94106	6" x 12"	FB
94123	6" x 12"	RFAL



129614	18" x 12"	SS
129613	18" x 12"	PL
129612	18" x 12"	AL



75219	14" x 20"	FB
43450	10" x 14"	AL



124316	18" x 12"	SS
124315	18" x 12"	PL
124314	18" x 12"	AL



75226	12" x 18"	FB
-------	-----------	----



124376	18" x 12"	SS
124375	18" x 12"	PL
124374	18" x 12"	AL



124373	18" x 12"	SS
124372	18" x 12"	PL
124371	18" x 12"	AL



80078	18" x 12"	RFAL
-------	-----------	------





































75227	18" x 12"	FB
-------	-----------	----

Traffic Signs

Parking Signs: E-Vehicles

A number of agencies are installing electric vehicle charging facilities at on-street parking locations as electric vehicles become more prevalent in the vehicle fleet.

					
141672 18" x 12" RFAL	141673 18" x 12" RFAL	141671 18" x 12" RFAL	141678 18" x 12" RFAL	141679 18" x 12" RFAL	141677 18" x 12" RFAL
					
141675 18" x 12" RFAL	141676 18" x 12" RFAL	141674 18" x 12" RFAL	141683 18" x 12" RFAL	141684 18" x 12" RFAL	141682 18" x 12" RFAL
					
141686 18" x 12" RFAL	141687 18" x 12" RFAL	141685 18" x 12" RFAL	141689 18" x 12" RFAL	141690 18" x 12" RFAL	141688 18" x 12" RFAL
					
141698 18" x 12" AL 141694 18" x 12" RFAL	141695 18" x 12" AL 141691 18" x 12" RFAL	141696 24" x 24" AL	141661 18" x 12" AL 141670 18" x 12" RFAL	141665 18" x 12" RFAL	141666 18" x 12" RFAL
					
141664 18" x 12" RFAL	141662 18" x 12" RFAL	141663 18" x 12" RFAL	141660 18" x 12" RFAL	141668 18" x 12" RFAL	141669 18" x 12" RFAL
					
141667 18" x 12" RFAL	141697 18" x 12" AL 141693 18" x 12" RFAL	141681 6" x 12" B-959	141680 6" x 12" RFAL		

Parking Signs: Handicapped

BradyID.com/s36

Parking Signs: Handicapped

Brady handicap signs are designed with bright colors and pictograms to clearly identify accommodations for those with disabilities or special needs.

Sign Selection Guide

- FB** - Premium fiberglass (B-120)
- SS** - Self-sticking polyester (B-302)
- PL** - Plastic (B-401)
- AL** - Aluminum (B-555)
- RFAL** - Reflective aluminum (B-959)

Material Guide..... page 408
Sign Legend Index..... page 588



94336 6' x 6' FB
91324 9' x 9' FB
94112 12' x 12' FB
91370 14' x 10' SS
94174 12' x 12' RFAL



91372 14' x 10' SS
91352 18' x 12' RFAL



91371 14' x 10' SS
91351 18' x 12' RFAL



69277 9' x 9' FB
88509 9' x 9' SS
25173 10' x 14' PL

ADA Handicapped Parking Guide

Parking Spaces Per Lot	Min Number of Reserved Spaces
1 to 25	1
26 to 50	2
51 to 75	3
76 to 100	4
101 to 150	5
151 to 200	6
201 to 300	7
301 to 400	8
401 to 500	9
501 to 1,000	2% of total SPACES
More than 1,000	20 plus 1 for every 100 over 1,000



91326 6' x 12' RFAL



91010 6' x 12' RFAL



80049 6' x 12' RFAL



112500 6' x 12' RFAL



123876 18' x 18' PL
123878 24' x 24' PL
123875 18' x 18' AL
123877 24' x 24' AL



91354 18' x 12' RFAL



91378 12' x 18' FB
91376 10' x 14' SS
91377 12' x 18' RFAL



91331 12' x 18' FB
91357 12' x 18' RFAL



91332 9' x 9' FB
91333 12' x 12' FB
76871 18' x 18' FB
91358 12' x 12' RFAL
91359 18' x 18' RFAL



103780 18' x 12' RFAL

Traffic Signs



80110 18' x 12' RFAL



91334 18' x 12' FB
91360 18' x 12' RFAL



123874 18' x 12' SS
123873 18' x 12' PL
123872 18' x 12' AL



91356 18' x 12' RFAL



90018 18' x 12' RFAL



91336 18' x 12' FB
91362 18' x 12' RFAL

Parking Signs: Handicapped

BradyID.com/s36

Parking Signs: Handicapped (continued)



145438 18" x 12" FB



145441 18" x 12" FB



127469 18" x 12" SS
127468 18" x 12" PL
127467 18" x 12" AL



123887 18" x 12" SS
123886 18" x 12" PL
123885 18" x 12" AL



115256 18" x 12" AL



127475 18" x 12" SS
127474 18" x 12" PL
127473 18" x 12" AL



127454 18" x 12" SS
127453 18" x 12" PL
127452 18" x 12" AL



103748 18" x 12" RFAL



94175 18" x 12" RFAL



123890 18" x 12" SS
123889 18" x 12" PL
123888 18" x 12" AL



127457 18" x 12" SS
127456 18" x 12" PL
127455 18" x 12" AL



127460 18" x 12" SS
127459 18" x 12" PL
127458 18" x 12" AL
115250 18" x 12" RFAL



127472 18" x 12" SS
127471 18" x 12" PL
127470 18" x 12" AL



127466 18" x 12" SS
127465 18" x 12" PL
127464 18" x 12" AL



91386 24" x 18" FB
91388 18" x 12" RFAL
91389 24" x 18" RFAL



127478 9" x 12" SS
127477 9" x 12" PL
127476 9" x 12" AL



127481 10" x 14" SS
127480 10" x 14" PL
127479 10" x 14" AL



91384 6" x 12" FB
91387 6" x 12" RFAL



123871 18" x 12" SS
123870 18" x 12" PL
123869 18" x 12" AL



127463 18" x 12" SS
127462 18" x 12" PL
127461 18" x 12" AL



91375 14" x 10" SS
91363 18" x 12" RFAL



Traffic Signs

Railroad Traffic Signs

BradyID.com/s36

Railroad Traffic Signs

Railroad specific signs are highly durable and visible in day or night conditions. Made in both blue and red, these new signs help you comply with the Federal Railroad Administration and OSHA regulations. In the railroad industry, blue is the traditional color for "STOP", and has been used in the rail industry to indicate protection of parked rail cars and the crews working on them. Red is also acceptable for OSHA compliance, as some states and local railroad regulations require red signs on industrial sidings (a low-speed track section).

Sign Selection Guide

Reflective aluminum rail signs are made of .080 inch thick engineer grade reflective aluminum (B-959) unless otherwise noted.

Material Guide..... page 408
Sign Legend Index..... page 588

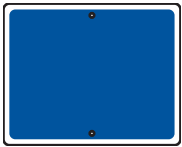

134193 12" x 15" RFAL

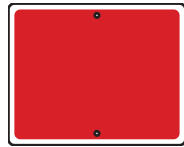

134194 12" x 15" RFAL



134177 12" x 15" RFAL



134178 12" x 15" RFAL



134190 12" x 15" RFAL



70537 10" x 14" FB



70536 10" x 14" FB



134184 12" x 15" RFAL



134183 12" x 15" RFAL



134187 12" x 15" RFAL



134188 12" x 15" RFAL



134186 12" x 15" RFAL



122897 7" x 10" FB
 75211 10" x 14" FB
 122691 7" x 10" SS
 122614 10" x 14" SS
 122493 10" x 14" PL
 122447 7" x 10" AL
 122379 10" x 14" AL



75212 12" x 15" FB



134191 12" x 15" RFAL



134192 12" x 15" RFAL

Traffic Signs

Road Construction Traffic Signs

Brady construction signs warn employees, pedestrians and visitors of the potential dangers of road or parking lot construction areas. These roll-up bright orange construction signs indicate temporary road closings, detours, shoulder work and more. Included flexible fiberglass frames fit into plastic or sewn corner pockets to achieve maximum performance, even in the windiest conditions.

Sign Selection Guide

Mesh - Non-reflective mesh

RF Vinyl - Reflective vinyl

Signs include flexible fiberglass frame.



57023 36" x 36" Mesh
57026 48" x 48" RF Vinyl



56795 36" x 36" RF Vinyl



56699 36" x 36" Mesh
56727 48" x 48" Mesh
56726 36" x 36" RF Vinyl



56750 36" x 36" RF Vinyl



56767 48" x 48" Mesh



56789 48" x 48" RF Vinyl



56791 36" x 36" RF Vinyl



56798 36" x 36" Mesh
56800 48" x 48" Mesh
56799 36" x 36" RF Vinyl



56818 48" x 48" RF Vinyl



56897 36" x 36" RF Vinyl



57001 48" x 48" Mesh
57002 48" x 48" RF Vinyl



57005 48" x 48" Mesh
57004 36" x 36" RF Vinyl
57006 48" x 48"



57014 48" x 48" RF Vinyl



57017 48" x 48" Mesh
57016 36" x 36" RF Vinyl
57018 48" x 48" RF Vinyl



57021 48" x 48" Mesh
57020 36" x 36" RF Vinyl
57022 48" x 48" RF Vinyl



57029 48" x 48" Mesh
57030 48" x 48" RF Vinyl



57031 36" x 36" Mesh
57033 48" x 48" Mesh
57032 36" x 36" RF Vinyl
57034 48" x 48" RF Vinyl



57037 36" x 36" Mesh
57036 48" x 48" Mesh
57038 36" x 36" RF Vinyl



Reflective Vinyl
57050 48" x 48"



Non-Reflective Mesh
57045 48" x 48"



Sign Stand and Warning Flags



Sign Tripod

Construction Sign Accessories

Catalog #	Description	Qty.
57067	Sign Stand	1
57069	Tripod	1
57072	Warning Flag Assembly	1
13377	Warning Flag	1
57070	36" Cross Ribs	1 set
57071	48" Cross Ribs	1 set



Construction Barricades and Traffic Cones on page 581.

Shipping and Receiving Signs

BradyID.com/s36

Shipping and Receiving Traffic

Brady traffic signs provide clear, concise direction to traffic inside and outside your building. These signs can be used in and around your shipping and receiving departments to keep visitor traffic safe and moving smoothly. Available in a variety of sizes and materials for both indoor or outdoor use.

Sign Selection Guide

- FB** - Premium fiberglass (B-120)
- SS** - Self-sticking polyester (B-302)
- PL** - Plastic (B-401)
- AL** - Aluminum (B-555)
- RFAL** - Reflective aluminum (B-959)

Material Guide..... page 408
Sign Legend Index..... page 588



69100	10' x 14'	FB
22052	10' x 14'	PL
40616	10' x 14'	AL



70223	10' x 14'	FB
25792	10' x 14'	PL
43369	10' x 14'	AL



75082	10' x 14'	FB
25795	10' x 14'	PL
43372	10' x 14'	AL



75118	10' x 14'	FB
25798	10' x 14'	PL
43375	10' x 14'	AL



129503	7' x 10'	SS
129506	10' x 14'	SS
129502	7' x 10'	PL
129505	10' x 14'	PL
129501	7' x 10'	AL
129504	10' x 14'	AL



124207	10' x 7'	SS
124210	14' x 10'	SS
124206	10' x 7'	PL
124209	14' x 10'	PL
124205	10' x 7'	AL
124208	14' x 10'	AL



25801	10' x 14'	PL
43378	10' x 14'	AL



124189	10' x 7'	SS
124192	14' x 10'	SS
124188	10' x 7'	PL
124191	14' x 10'	PL
124187	10' x 7'	AL
124190	14' x 10'	AL



129509	7' x 10'	SS
129512	10' x 14'	SS
129508	7' x 10'	PL
129511	10' x 14'	PL
129507	7' x 10'	AL
129510	10' x 14'	AL



124195	7' x 10'	SS
124198	10' x 14'	SS
124194	7' x 10'	PL
124197	10' x 14'	PL
124193	7' x 10'	AL
124196	10' x 14'	AL



129515	7' x 10'	SS
129518	10' x 14'	SS
129514	7' x 10'	PL
129517	10' x 14'	PL
129513	7' x 10'	AL
129516	10' x 14'	AL



85427	7' x 10'	SS
85428	10' x 14'	SS
22719	7' x 10'	PL
22720	10' x 14'	PL
41283	7' x 10'	AL
41284	10' x 14'	AL



63208	2' x 24'	SS
-------	----------	----



63203	10' x 14'	SS
-------	-----------	----



63204	14' x 10'	SS
-------	-----------	----



129521	7' x 10'	SS
129524	10' x 14'	SS
129520	7' x 10'	PL
129523	10' x 14'	PL
129519	7' x 10'	AL
129522	10' x 14'	AL

Regulations

Federal MUTCD Standard:

No person shall install or maintain in any area of private property used by the public any sign, signal, marking or other device intended to regulate, warn or guide traffic unless it conforms to the MUTCD.

Traffic Signs and Reflectivity Section 2A.0702 of MUTCDs

Stipulates that regulatory, warning, and guide signs and object markers shall be retroreflective or illuminated to show the same shape and similar color by both day and night. Most of Brady's retroreflective signs are "engineer grade". Higher intensity "Diamond Grade" signs are available as custom options.

All posts used for mounting must be breakaway style and mounted at new minimum mounting heights

All supports require breakaway sockets or posts. Minimum mounting height is 5' from the bottom of the sign to the top of the ground in rural or low-volume areas. Minimum mounting height is 7' from the bottom of the sign in urban or heavily traveled areas.

Notice: Chock Rear Wheels 1910.178(k) and (m)

When trucks are loaded and unloaded, OSHA requires the brakes to be set and wheel chocks to be placed under the rear wheels to prevent the trucks from rolling while they are boarded with a forklift or other powered industrial truck.

Shipping and Receiving Signs

BradyID.com/s36



69176 10" x 14" FB
25806 10" x 14" PL
43383 10" x 14" AL



129527 7" x 10" SS
129530 10" x 14" SS
129526 7" x 10" PL
129529 10" x 14" PL
129525 7" x 10" AL
129528 10" x 14" AL



75115 14" x 20" FB
25807 10" x 14" PL
43384 10" x 14" AL



129455 7" x 10" SS
129458 10" x 14" SS
129454 7" x 10" PL
129457 10" x 14" PL
129453 7" x 10" AL
129456 10" x 14" AL



73405 10" x 14" FB
70212 14" x 20" FB
25819 10" x 14" PL
43396 10" x 14" AL



89129 7" x 10" SS
43464 10" x 14" AL



129533 7" x 10" SS
129536 10" x 14" SS
129532 7" x 10" PL
129535 10" x 14" PL
129531 7" x 10" AL
129534 10" x 14" AL



75123 14" x 20" FB
25828 10" x 14" PL
43405 10" x 14" AL



70457 10" x 14" FB
25830 10" x 14" PL
43407 10" x 14" AL



25832 10" x 14" PL
43409 10" x 14" AL



129539 7" x 10" SS
129542 10" x 14" SS
129538 7" x 10" PL
129541 10" x 14" PL
129537 7" x 10" AL
129540 10" x 14" AL



89155 7" x 10" SS
25833 10" x 14" PL
43410 10" x 14" AL



69539 10" x 14" FB
25834 10" x 14" PL
43411 10" x 14" AL



25835 10" x 14" PL
43412 10" x 14" AL



73424 10" x 14" FB
25836 10" x 14" PL
43413 10" x 14" AL



75147 14" x 20" FB
25839 10" x 14" PL
43416 10" x 14" AL



69562 7" x 17" FB



129545 7" x 10" SS
129548 10" x 14" SS
129544 7" x 10" PL
129547 10" x 14" PL
129543 7" x 10" AL
129546 10" x 14" AL



129551 7" x 10" SS
129554 10" x 14" SS
129550 7" x 10" PL
129553 10" x 14" PL
129549 7" x 10" AL
129552 10" x 14" AL



129557 7" x 10" SS
129560 10" x 14" SS
129556 7" x 10" PL
129559 10" x 14" PL
129555 7" x 10" AL
129558 10" x 14" AL



132055 7" x 10" FB
132056 10" x 14" FB
132053 7" x 10" SS
132054 10" x 14" SS
132051 7" x 10" PL
132052 10" x 14" PL
132049 7" x 10" AL
132050 10" x 14" AL



70218 18" x 24" FB
25845 10" x 14" PL
43422 10" x 14" AL



129485 7" x 10" SS
129488 10" x 14" SS
129484 7" x 10" PL
129487 10" x 14" PL
129483 7" x 10" AL
129486 10" x 14" AL

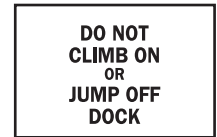

75091 10" x 14" FB
25848 10" x 14" PL
43425 10" x 14" AL



63207 10" x 14" SS



75097 10" x 14" FB
25849 10" x 14" PL
43426 10" x 14" AL



63210 10" x 14" SS



129491 7" x 10" SS
129494 10" x 14" SS
129490 7" x 10" PL
129493 10" x 14" PL
129489 7" x 10" AL
129492 10" x 14" AL



89136 7" x 10" SS
25890 10" x 14" PL
43467 10" x 14" AL

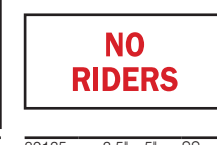

89135 3.5" x 5" SS

Traffic Signs

Shipping and Receiving Signs

BradyID.com/s36

Shipping and Receiving Signs (continued)



25857	10" x 14"	PL
43434	10" x 14"	AL

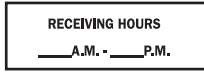

75183	7" x 20"	FB
-------	----------	----



75156	14" x 20"	FB
25869	10" x 14"	PL



75155	14" x 20"	FB
25864	10" x 14"	PL



70526	10" x 28"	FB
-------	-----------	----



70503	10" x 28"	FB
-------	-----------	----

Sign Selection Guide

FB - Premium fiberglass (B-120)
SS - Self-sticking polyester (B-302)
PL - Plastic (B-401)
AL - Aluminum (B-555)
RFAL - Reflective aluminum (B-959)

Material Guide..... page 408
Sign Legend Index..... page 588



124499	7" x 10"	SS
124502	10" x 14"	SS
124498	7" x 10"	PL
124501	10" x 14"	PL
124497	7" x 10"	AL
124500	10" x 14"	AL



124493	7" x 10"	SS
124496	10" x 14"	SS
124492	7" x 10"	PL
124495	10" x 14"	PL
124491	7" x 10"	AL
124494	10" x 14"	AL



132103	10" x 14"	FB
75198	14" x 20"	FB
25870	10" x 14"	PL
43447	10" x 14"	AL



124439	18" x 12"	SS
124438	18" x 12"	PL
124437	18" x 12"	AL



124531	18" x 18"	PL
124533	24" x 24"	PL
124530	18" x 18"	AL
124532	24" x 24"	AL



124451	18" x 12"	SS
124450	18" x 12"	PL
124449	18" x 12"	AL



124535	18" x 18"	PL
124537	24" x 24"	PL
124534	18" x 18"	AL
124536	24" x 24"	AL



124555	18" x 18"	PL
124557	24" x 24"	PL
124554	18" x 18"	AL
124556	24" x 24"	AL



124511	18" x 18"	PL
124513	24" x 24"	PL
124510	18" x 18"	AL
124512	24" x 24"	AL



76090	12" x 15"	FB
-------	-----------	----



124519	18" x 18"	PL
124521	24" x 24"	PL
124518	18" x 18"	AL
124520	24" x 24"	AL



124523	18" x 18"	PL
124525	24" x 24"	PL
124522	18" x 18"	AL
124524	24" x 24"	AL



124430	18" x 12"	SS
124429	18" x 12"	PL
124428	18" x 12"	AL



124515	18" x 18"	PL
124517	24" x 24"	PL
124514	18" x 18"	AL
124516	24" x 24"	AL



124559	18" x 18"	PL
124561	24" x 24"	PL
124558	18" x 18"	AL
124560	24" x 24"	AL



124507	18" x 18"	PL
124509	24" x 24"	PL
124506	18" x 18"	AL
124508	24" x 24"	AL



124547	18" x 18"	PL
124549	24" x 24"	PL
124546	18" x 18"	AL
124548	24" x 24"	AL

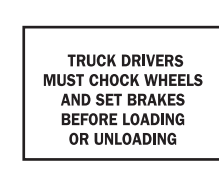

75215	10" x 14"	FB
25871	10" x 14"	PL
43448	10" x 14"	AL



70562	14" x 20"	FB
25872	10" x 14"	PL
43449	10" x 14"	AL



129497	7" x 10"	SS
129500	10" x 14"	SS
129496	7" x 10"	PL
129499	10" x 14"	PL
129495	7" x 10"	AL
129498	10" x 14"	AL



75157	10" x 14"	FB
75158	14" x 20"	FB
25875	10" x 14"	PL
43452	10" x 14"	AL



124616	18"	PL
124618	24"	PL
124615	18"	RFAL
124617	24"	RFAL



124612	18"	PL
124614	24"	PL
124611	18"	RFAL
124613	24"	RFAL

Traffic Signs

Shipping and Receiving Signs

BradyID.com/s36

Traffic Control Signs

Brady traffic signs provide clear, concise direction to traffic outside your building. They guide vehicle traffic with easily recognizable roadway messages. Available in a variety of sizes and materials, Brady these signs can be used in crosswalks, parking lots and more.

Sign Selection Guide

FB - Premium fiberglass (B-120)
SS - Self-sticking polyester (B-302)
PL - Plastic (B-401)
AL - Aluminum (B-555)
RFAL - Reflective aluminum (B-959)

Material Guide..... page 408
Sign Legend Index..... page 588



80055 9' x 12' RFAL

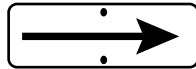

75063 5' x 14' FB



80060 9' x 12' RFAL

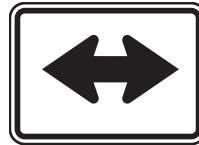

80061 9' x 12' RFAL



124580 18' x 18' PL
 124582 24' x 24' PL
 124579 18' x 18' AL
 124581 24' x 24' AL

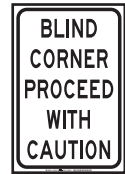

129470 18' x 12' SS
 129469 18' x 12' PL
 129468 18' x 12' AL



70230 14' x 20' FB



124463 18' x 12' SS
 124462 18' x 12' PL
 124461 18' x 12' AL



46979 7' x 10' FB
 87301 10' x 14' FB
 89131 7' x 10' SS
 89132 10' x 14' SS
 43465 10' x 14' AL



94225 24' x 24' RFAL



124592 18' x 18' PL
 124594 24' x 24' PL
 124591 18' x 18' AL
 124593 24' x 24' AL



124201 10' x 7' SS
 124204 14' x 10' SS
 124200 10' x 7' PL
 124203 14' x 10' PL
 124199 10' x 7' AL
 124202 14' x 10' AL



80100 18' x 12' RFAL



124273 24' x 36' SS
 124272 24' x 36' PL
 124271 24' x 36' AL



129431 18' x 12' SS
 129430 18' x 12' PL
 129429 18' x 12' AL



129428 18' x 12' SS
 129427 18' x 12' PL
 129426 18' x 12' AL



129479 12' x 18' SS
 129478 12' x 18' PL
 129477 12' x 18' AL



129578 18' x 12' SS
 129577 18' x 12' PL
 129576 18' x 12' AL



124355 18' x 12' SS
 124354 18' x 12' PL
 124353 18' x 12' AL



129452 18' x 12' SS
 129451 18' x 12' PL
 129450 18' x 12' AL



75094 24' x 24' FB



75093 30' x 30' FB
 80076 24' x 24' RFAL
 94150 30' x 30' RFAL



80101 24' x 6' RFAL
 80102 36' x 12' RFAL



80103 24' x 6' RFAL
 80104 36' x 12' RFAL

High Intensity Ref. Alum.
 95041 30' x 30' -

Traffic Signs

Traffic Control Signs

BradyID.com/s36



129473 18" x 12" SS
129472 18" x 12" PL
129471 18" x 12" AL



124460 18" x 12" SS
124459 18" x 12" PL
124458 18" x 12" AL



129584 18" x 12" SS
129583 18" x 12" PL
129582 18" x 12" AL



129581 18" x 12" SS
129580 18" x 12" PL
129579 18" x 12" AL

Sign Selection Guide

FB - Premium fiberglass (B-120)
SS - Self-sticking polyester (B-302)
PL - Plastic (B-401)
AL - Aluminum (B-555)
RFAL - Reflective aluminum (B-959)

Material Guide..... page 408
Sign Legend Index..... page 588



129671 18" x 12" SS
129670 18" x 12" PL
129669 18" x 12" AL



80094 18" x 18" RFAL



94180 18" x 18" RFAL



94181 18" x 18" RFAL



80091 18" x 18" RFAL



75110 18" x 18" FB
115475 18" x 18" RFAL



75111 18" x 18" FB
94183 18" x 18" RFAL



75113 18" x 18" FB
94185 18" x 18" RFAL



124406 18" x 12" SS
124405 18" x 12" PL
124404 18" x 12" AL



124608 18" x 18" PL
124610 24" x 24" PL
124607 18" x 18" AL
124609 24" x 24" AL



94190 24" x 18" RFAL

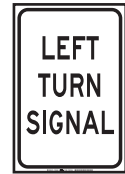

129464 18" x 12" SS
129463 18" x 12" PL
129462 18" x 12" AL



129590 18" x 12" SS
129589 18" x 12" PL
129588 18" x 12" AL



80108 18" x 12" RFAL



124415 12" x 18" SS
124414 12" x 18" PL
124413 12" x 18" AL



124412 18" x 12" SS
124411 18" x 12" PL
124410 18" x 12" AL



124427 18" x 12" SS
124426 18" x 12" PL
124425 18" x 12" AL



124596 18" x 18" PL
124598 24" x 24" PL
124595 18" x 18" AL
124597 24" x 24" AL



129437 18" x 12" SS
129436 18" x 12" PL
129435 18" x 12" AL



124403 18" x 12" SS
124402 18" x 12" PL
124401 18" x 12" AL



129476 18" x 12" SS
129475 18" x 12" PL
129474 18" x 12" AL



129482 18" x 12" SS
129481 18" x 12" PL
129480 18" x 12" AL



25858 7" x 10" PL
43435 7" x 10" AL



80098 24" x 18" RFAL

Traffic Control Signs (continued)



124409 12" x 18" SS
124408 12" x 18" PL
124407 12" x 18" AL



80105 6" x 12" RFAL



80109 18" x 12" RFAL



94163 24" x 24" RFAL



94192 24" x 24" RFAL



124457 12" x 18" SS
124456 12" x 18" PL
124455 12" x 18" AL



124442 18" x 12" SS
124441 18" x 12" PL
124440 18" x 12" AL



80095 18" x 12" RFAL



75066 24" x 24" FB



75161 24" x 18" FB
94195 24" x 18" RFAL



75162 24" x 18" FB
94197 24" x 18" RFAL

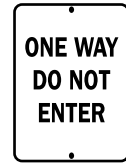

94199 24" x 18" RFAL



94234 24" x 24" RFAL
94235 30" x 30" RFAL



94222 24" x 24" RFAL
113319 30" x 30" RFAL



94237 18" x 24" RFAL



129434 18" x 12" SS
129433 18" x 12" PL
129432 18" x 12" AL



129440 12" x 18" SS
129439 12" x 18" PL
129438 12" x 18" AL



76087 10" x 14" FB

Diamond Grade Ref. Alum.
80068 24" x 24" B-995
80067 30" x 30" B-995



129680 12" x 18" SS
129679 12" x 18" PL
129678 12" x 18" AL



75178 18" x 18" FB



80106 18" x 12" RFAL



75180 14" x 20" FB
43440 10" x 14" AL



129599 18" x 12" SS
129598 18" x 12" PL
129597 18" x 12" AL



124475 12" x 18" SS
124474 12" x 18" PL
124473 12" x 18" AL



94307 30" x 30" RFAL



129443 18" x 12" SS
129442 18" x 12" PL
129441 18" x 12" AL



129446 12" x 18" SS
129445 12" x 18" PL
129444 12" x 18" AL



80099 24" x 24" RFAL



124466 18" x 12" SS
124465 18" x 12" PL
124464 18" x 12" AL

Traffic Control Signs

BradyID.com/s36

Traffic Control Signs (continued)



94240 24" x 18" RFAL



124436 18" x 12" SS
124435 18" x 12" PL
124434 18" x 12" AL



129425 18" x 12" SS
129424 18" x 12" PL
129423 18" x 12" AL



124424 18" x 12" SS
124423 18" x 12" PL
124422 18" x 12" AL

Sign Selection Guide

- FB** - Premium fiberglass (B-120)
- SS** - Self-sticking polyester (B-302)
- PL** - Plastic (B-401)
- AL** - Aluminum (B-555)
- RFAL** - Reflective aluminum (B-959)

Material Guide..... page 408
Sign Legend Index..... page 588



103786 24" x 18" RFAL
Diamond Grade Ref. Alum.
103712 24" x 18" B-995



124397 18" x 12" SS
124396 18" x 12" PL
124395 18" x 12" AL



124400 18" x 12" SS
124399 18" x 12" PL
124398 18" x 12" AL



124490 18" x 12" SS
124489 18" x 12" PL
124488 18" x 12" AL



124487 18" x 12" SS
124486 18" x 12" PL
124485 18" x 12" AL



124584 18" x 18" PL
124586 24" x 24" PL
124583 18" x 18" AL
124585 24" x 24" AL



75199 24" x 18" FB
115239 18" x 12" AL
94210 24" x 18" RFAL



75200 24" x 18" FB
115222 18" x 12" AL
94211 24" x 18" RFAL



75201 24" x 18" FB
115240 18" x 12" AL
94212 24" x 18" RFAL



76088 24" x 18" FB
94213 24" x 18" RFAL



75203 24" x 18" FB
94209 24" x 18" RFAL



80073 18" x 18" RFAL
80074 30" x 30" RFAL
80075 36" x 36" RFAL

Traffic Signs



75205 18" x 18" FB
75206 24" x 24" FB
75207 30" x 30" FB
115589 12" x 12" AL
113280 18" x 18" RFAL
94142 18" x 18" RFAL
94143 24" x 24" RFAL
94144 30" x 30" RFAL
94145 36" x 36" RFAL



124621 7" x 17" SS
124620 7" x 17" PL
124619 7" x 17" AL



124421 18" x 12" SS
124420 18" x 12" PL
124419 18" x 12" AL



124433 18" x 12" SS
124432 18" x 12" PL
124431 18" x 12" AL



129461 18" x 12" SS
129460 18" x 12" PL
129459 18" x 12" AL



124448 18" x 12" SS
124447 18" x 12" PL
124446 18" x 12" AL

High Intensity Ref. Alum.
95043 18" x 18" -
95044 24" x 24" -
95045 30" x 30" -
95046 36" x 36" -

Traffic Control Signs (continued)



129467	12' x 18"	SS
129466	12' x 18"	PL
129465	12' x 18"	AL



124481	18' x 12"	SS
124480	18' x 12"	PL
124479	18' x 12"	AL



124484	18' x 12"	SS
124483	18' x 12"	PL
124482	18' x 12"	AL



124478	18' x 12"	SS
124477	18' x 12"	PL
124476	18' x 12"	AL



124418	12' x 18"	SS
124417	12' x 18"	PL
124416	12' x 18"	AL



94218	18' x 24"	RFAL
-------	-----------	------



124469	12' x 18"	SS
124468	12' x 18"	PL
124467	12' x 18"	AL



124472	12' x 18"	SS
124471	12' x 18"	PL
124470	12' x 18"	AL



124600	18' x 18"	PL
124602	24' x 24"	PL
124599	18' x 18"	AL
124601	24' x 24"	AL



124445	18' x 12"	SS
124444	18' x 12"	PL
124443	18' x 12"	AL



129449	12' x 18"	SS
129448	12' x 18"	PL
129447	12' x 18"	AL



124588	18' x 18"	PL
124590	24' x 24"	PL
124587	18' x 18"	AL
124589	24' x 24"	AL



124604	18' x 18"	PL
124606	24' x 24"	PL
124603	18' x 18"	AL
124605	24' x 24"	AL



124454	18' x 12"	SS
124453	18' x 12"	PL
124452	18' x 12"	AL



94152	18' x 30"	RFAL
High Intensity Ref. Alum.		
95040	18' x 30"	-



75062	24"	FB
80071	18"	RFAL
94148	24"	RFAL
80072	30"	RFAL

High Intensity Ref. Alum.		
95039	30"	-
95042	36"	-

Stop for Pedestrians Crosswalk Sign and Stand

103709 40' x 14" AL
Aluminum sign on molded plastic stand.



Sign Accessories

BradyID.com/s36

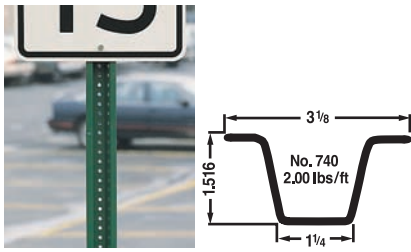

U-Channel Sign Posts

- Powder-coated high-tensile steel
- Weight: two pounds per linear foot
- 3/8 in. holes, 1 in. on center
- Hardware sold separately below

Catalog #	Description	Size
95047	U-Channel Sign Post	6 ft.
97204	U-Channel Sign Post	8 ft.
97205	U-Channel Sign Post	10 ft.
97206	U-Channel Sign Post	12 ft.



Vandal-Proof Tufnut™ for U-Channel Post

- Plated steel nut secures tightly to prevent sign theft
- 5/16 in. nut for use with U-Channel Sign Posts (sold separately)

Catalog #	Description
97211	2 Bolts, 2 Washers, 3 Tufnuts



Sign Base

- Mounts with three expansion bolts
- 15 in. diameter cast aluminum base includes post mount stub and hardware

Catalog #	Description	Qty.
86339	15 in. Diameter Base	1

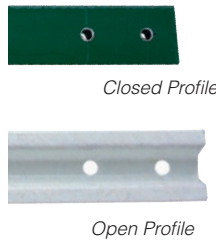

Tuff-N-Light™ U-Channel Post

- Ideal for traffic and industrial signage
- Closed profile posts are 6 times torsionally stronger than steel posts
- Open profile style can accommodate signs up to 12 in. x 18 in.

Catalog #	Description	Size	Color
97208	Closed profile	8 ft.	White
97210	Closed profile	8 ft.	Green
97207	Open profile	8 ft.	White
97209	Open profile	8 ft.	Green

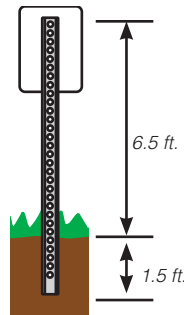

NuLock II™ Fastener for Tuff-N-Light Posts

- Nylon fastener with adjustable tightening
- Reusable or cut off slip wings for permanent applications
- Use with Tuff-N-Light Sign Posts

Catalog #	Description
90913	NuLock II - 2 stems and 2 clips



Sign Base Stub Hardware

- Aluminum hardware is ideal for indoor or outdoor use
- Base: 4.25 in. H x 3.25 in. W x 2.5 in. D

Catalog #	Description	Qty.
145962	Sign Base Hardware	1

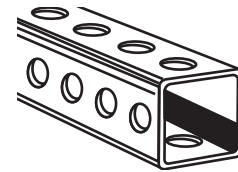

Galvanized Posts

- Galvanized steel posts are manufactured of a high tensile steel and resist corrosion
- Square posts have 7/6 in. dia. holes on 1 in. centers along length of all sides

Catalog #	Shape	Size	Length
78998	Square	2 in. x 2 in.	8 ft.



Sign Mounting Brackets

- Aluminum mounting brackets ideal for indoor or outdoor use
- Fastens sign securely to round 2.35 in. outer diameter posts

Catalog #	Description	Qty.
103559	Sign Brackets	2

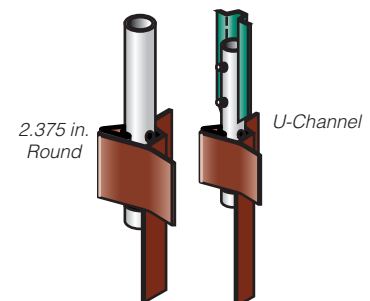

V-Loc Breakaways

- Steel fins hold the socket securely in concrete, asphalt or dirt
- Allows post to break off cleanly at ground level if struck
- Easily replaceable posts

Catalog #	Shape	Qty.
78991	Round w/ Wedge	1
78993	U-Channel w/ Wedge and Adaptor	1

Custom Signs and Accessories



Flexible Sign Post

- Polypropylene post is equipped with reactive springs to endure collisions
- Can be mounted to asphalt or concrete
- Includes hardware and installation kit

Catalog #	Color	Height	Base	Qty.
103569	White	5 ft.	8 in. x 8 in.	1
103570	Yellow	5 ft.	8 in. x 8 in.	1



Mounting Tape

- Indoor / outdoor, double-faced foam tape
- Bonds well to rough, irregular surfaces
- Service temp. range: 50° F to 180° F

Catalog #	Description	Size	Qty.
78272	Roll Mounted	0.5 in. x 108 ft.	1 roll
78273	Roll Mounted	0.75 in. x 108 ft.	1 roll
19811	Roll Mounted	1 in. x 108 ft.	1 roll
97200	Card Mounted	0.75 in. x 4.5 in.	1 card of 4



Moveable Sign Posts

- Black baked enamel finish
- Small - 14 in. dia., 16 lb cast iron base Post: 48 in. tall, 1 in. dia., pre-drilled for 18 in. x 12 in. signs
- Large - 17 in. dia., 35 lb cast iron base Post: 48 in. tall, 1.5 in. dia., pre-drilled for 18 in. x 18 in., 24 in. x 18 in. or 24 in. x 24 in. signs

Catalog #	Description	Color	Qty.
86336	Small: 16 lb base	Black	1
86345	Large: 35 lb base	Black	1



Tape Strips

- Use for mounting signs or bin panels to rough surfaces
- Double-coated foam strips have adhesive on both sides

Catalog #	Description	Size	Qty.
58300	Tape Strips	1 in. x 4 in.	10

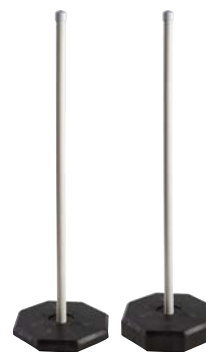

Rubber Sign Post

- Moveable post for indoors or outdoors
- 100% recycled rubber base won't chip, crack or rust
- Fits signs 18 in. x 12 in. or 24 in. x 24 in.

Catalog #	Color	Base	Qty.
103566	White	20 lb	1
103567	White	30 lb	1
103568	White	60 lb	1



Magnetic Strips

- Magnetic mounting strips with pressure sensitive adhesive on one side

Catalog #	Description	Size	Qty.
58301	Magnetic Strips	1 in. x 4 in.	10



Sign Holders

- Clear acrylic holder protects your sign
- May be hung vertically or horizontally

Catalog #	Size	Color	Qty.
SH710	7 in. x 10 in.	Clear	1
SH912	9 in. x 12 in.	Clear	1
SH1014	10 in. x 14 in.	Clear	1
SH1219	11.375 in. x 19.06 in.	Clear	1
SH1420	14 in. x 20 in.	Clear	1
SH1824	18 in. x 24 in.	Clear	1

Sign Accessories

BradyID.com/s36

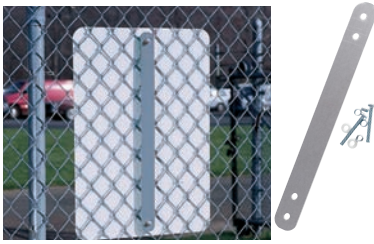

Fence Sign Brackets

- Easily attaches signs to fences
- Brackets are constructed of 14 gauge steel with a green baked enamel finish
- Mounting hardware included

Catalog #	Description
86337	17 in. bracket for 18 in. x 12 in. or 18 in. x 18 in.
86338	22 in. bracket for 12 in. x 18 in. or 24 in. x 24 in.



BriteSide™ Reflective Panels

- Create a reflective u-channel post
- Highly-reflective diamond-grade material
- Mounting hardware included

Catalog #	Description	Color	Size	Qty.
95036	Reflective Panel	Blue	3 in. x 6 ft.	1
95037	Reflective Panel	Red	3 in. x 6 ft.	1
95038	Reflective Panel	Yellow	3 in. x 6 ft.	1



Stainless Steel Coil

- Strapping coil in dispensing box for attaching street sign accessories to sign posts

Catalog #	Description	Qty.
56694	Stainless Steel Coil	1

Custom Signs and Accessories

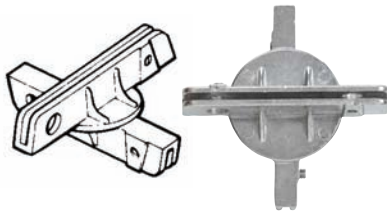

Street Sign 4-Way Cross Piece

- Mount on top of another street sign for additional sign

Catalog #	Description	Qty.
56681	4-Way Cross Piece	1



Street Sign Tubular Post Top

- Attach to top of post to mount a street sign

Catalog #	Description	Qty.
56687	Tubular Post Top	1

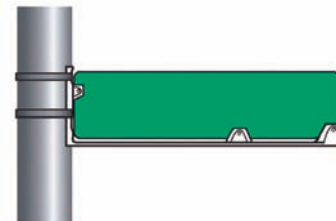

Street Sign Jumbo Wing Bracket

- 21 in. bracket can mount 9 in. high street name blades

Catalog #	Description	Qty.
56688	Wing Bracket	1

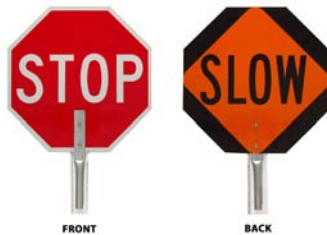

Traffic Control Paddles

- Made of durable aluminum
- 18 in. octagons weight 2 lbs
- 5 ft. aluminum handle also available

Catalog #	Description	Qty.
57754	Stop / Slow	1
57755	Stop on both sides	1
55775	Stop / Go	1
55784	5 ft. Handle Extension	1



Emergency Triangles

- Reflector for day and night visibility
- Solid weighted base for stability
- 13 lbs each

Catalog #	Description	Qty.
57892	Emergency Triangles	3



Slow Moving Vehicle Sign

- For vehicles traveling 25 mph or less
- Hardware not included

Catalog #	Size	Material	Qty.
57893	14 in. x 16 in.	Vinyl	1
57894	14 in. x 16 in.	Steel	1
57895	14 in. x 16 in.	Aluminum	1

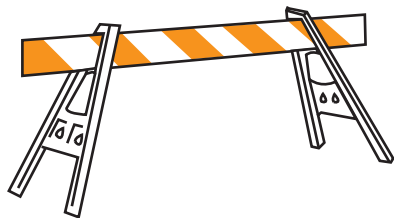

A-Frame Barricades

- Made from impact-resistant polyethylene
- Legs are 42 in. high and base is 28 in. wide

Catalog #	Description	Length	Qty.
57073	Single Board	6 ft.	1
57445	Single Board	8 ft.	1
57446	Single Board	10 ft.	1
57502	Double Board	6 ft.	1
57593	Double Board	8 ft.	1
57594	Double Board	10 ft.	1



Traffic Barrel

- Designed to break-away from base if struck
- Includes 25 lb rubber ring for stability and wind resistance

Catalog #	Description	Qty.
57771	40 in. tall and 4 in. high base	1



Pavement Tape

- Apply to clean, dry pavement
- Instantly conforms to the road surface
- High retro-directive reflectivity
- Exceeds federal specification requirements for permanent tape

Catalog #	Description	Color	Size
78263	Pavement Tape	White	4 in. x 150 ft.
78264	Pavement Tape	Yellow	4 in. x 150 ft.



Metal Folding Barricades

- Made of high density polyethylene
- **Style One:** Reflective sheeting on upper
- **Style Two:** Reflective sheeting on upper and lower panels

Catalog #	Style	Size	Qty.
57596	Metal Style One	42 in. x 24 in.	1
57597	Metal Style Two	42 in. x 24 in.	1



Plastic Folding Barricades

- Made of rugged polyethylene
- **Style One:** Reflective sheeting on upper
- **Style Two:** Reflective sheeting on upper and lower panels

Catalog #	Style	Size	Qty.
57630	Plastic Style Narrow	36 in. x 16 in.	1
57599	Plastic Style One	45 in. x 25 in.	1
57627	Plastic Style Two	45 in. x 25 in.	1



Traffic Cones

- Vinyl construction assures flexible, yet rugged durability

Catalog #	Description	Qty.
80111	18 in. Cone	1
80112	24 in. Cone	1



Temporary Pavement Tape

- Foil-backed vinyl, coated with sand and reflective beads
- Bonds temporarily to clean, dry surfaces making it ideal for low traffic areas

Catalog #	Description	Color	Size
78261	Economy Tape	White	4 in. x 150 ft.
78262	Economy Tape	Yellow	4 in. x 150 ft.



Design Online Custom Safety Signs



With Brady's online design tool, creating custom safety signs is simple, affordable and fast.

- Custom message
- Variety of materials
- No minimum order
- Sizes range from 3.5 in. to 36 in.
- Ships quickly

Design your signs at
BradyID.com



Safety Sign Headers

ANSI and OSHA specify that safety signs must indicate and define specific hazards that, without identification, may lead to accidental injury to workers, customers or the general public. Standard headers and definitions are:

DANGER	WARNING	CAUTION	NOTICE	SAFETY
<ul style="list-style-type: none"> Indicates an imminently hazardous situation which if not avoided, will result in death or serious injury. Limited to most extreme situations. Not used for property damage hazards unless personal injury risk to this level is also involved. 	<ul style="list-style-type: none"> Indicates a potentially hazardous situation which, if not avoided, could result in death or serious injury. Not used for property damage hazards unless personal injury risk is also involved. Appropriate for outside of the area or on the exterior of enclosures containing a danger-level hazard. 	<ul style="list-style-type: none"> Indicates a potentially hazardous situation which, if not avoided, may result in minor or moderate injury. May be used to alert against unsafe practices that may cause property damage. 	<ul style="list-style-type: none"> Indicates a statement of company policy directly or indirectly related to the safety of personnel or protection of property. Should not be associated with a hazard or hazardous situation, and shall not be used in place of DANGER, WARNING or CAUTION. 	<ul style="list-style-type: none"> Indicate general instructions relative to safe work practices or indicate the location of safety equipment (e.g. eye wash station)

Sign Material Guide

Brady offers a sign material for virtually every application. Whether the sign is used indoors or outdoors, in mild or harsh environments, we have the material to match your application.

Material Type	Description	Protected Graphics	For Outdoor Use	Average Outdoor Durability	Chemical Resistance	Abrasion Resistance	Max. Temp	Thickness (inch)
Flexible Sign Materials								
Adhesive	B-302 High performance polyester	✓	✓	8 years	Excellent	Excellent	230° F (100° C)	.006-.010
Adhesive	B-324 BradyGlo™ photoluminescent polyester	-	-	-	Good	Good	176° F (80° C)	.008
Adhesive	B-485 Polyester film	✓	-	-	Good	Good	122° F (50° C)	.011
Adhesive	B-523 Photoluminescent polyester film	-	-	-	Good	Good	176° F (80° C)	.0096
Adhesive	B-534 Polyester floor sign with anti-skid tread	✓	-	-	Good	Good	130° F (54° C)	.011
Adhesive	B-808 BradyGlo anti-slip polyester floor sign	✓	-	-	Good	Good	158° F (70° C)	.017
Adhesive	B-819 Anti-slip vinyl floor sign	✓	-	-	Good	Good	158° F (70° C)	.012
Adhesive	B-928 Write-on vinyl with cold temp adhesive	-	✓	2 years	Good	Good	176° F (80° C)	.005
Adhesive	B-946 Self-sticking vinyl	-	✓	10 years	Fair	Good	180° F (82° C)	.004
Adhesive	B-984 Photoluminescent polyester film	-	-	-	Good	Good	175° F (80° C)	.013
Adhesive	B-997 BradyLite® reflective vinyl	-	✓	4-6 years	Good	Good	200° F (93° C)	.007
Non-Adhesive	B-101 Polycoated tagstock	-	-	-	Good	Good	158° F (70° C)	.010
Non-Adhesive	B-586 Eco-friendly paperboard	-	-	-	Good	Good	175° F (80° C)	.060
Non-Adhesive	B-811 Magnetic vinyl	-	✓	2-4 years	Good	Good	158° F (70° C)	.025
Rigid Sign Materials								
Metal	B-555 Aluminum	✓	✓	8 years	Excellent	Excellent	230° F (110° C)	.040-.090
Metal	B-959 Reflective aluminum	-	✓	4-8 years	Good	Good	175° F (80° C)	.040-.080
Metal	B-986 Photoluminescent polyester film on aluminum	-	-	-	Good	Good	175° F (80° C)	.049
Metal	B-995 Diamond-grade™ reflective aluminum	-	✓	7 years	Good	Good	212° F (100° C)	.097
Fiberglass	B-120 Premium fiberglass	✓	✓	25 years	Excellent	Excellent	193° F (90° C)	.100
Fiberglass	B-140 Polyester on fiberglass	✓	✓	8 years	Excellent	Excellent	175° F (79° C)	.070
Fiberglass	B-320 Sub surface printed lexan on fiberglass	✓	✓	8 years	Good	Good	175° F (79° C)	.070
Fiberglass	B-382 Sub surface printed polycarbonate on fiberglass	✓	✓	8 years	Good	Good	175° F (79° C)	.090
Plastic	B-1 Thermoset plastic	-	✓	8 years	Good	Good	193° F (89° C)	.062
Plastic	B-347 BradyGlo™ phosphorescent polyester on polystyrene	-	-	-	Good	Good	175° F (79° C)	.068
Plastic	B-355 BradyGlo steel encased photoluminescent plastic	-	-	-	Good	Good	122° F (50° C)	.250
Plastic	B-401 Polystyrene plastic	✓	✓	5 years	Good	Good	175° F (79° C)	.060
Plastic	B-450 Polyethylene plastic	-	-	-	Good	Good	180° F (82° C)	.055
Plastic	B-493 Plastic v-shaped signs	-	✓	2 years	Good	Good	193° F (90° C)	.100
Plastic	B-563 Eco-friendly plastic (70% post consumer waste)	-	✓	5 years	Good	Good	185° F (85° C)	.055
Plastic	B-793 Polystyrene	-	✓	1-3 years	Poor	Good	165° F (74° C)	-
Plastic	B-836 Temporary sign fluted polypropylene	-	✓	1 year	Good	Good	130° F (54° C)	.156
Plastic	B-866 ToughWash® Polypropylene	✓	-	-	Excellent	Good	175° F (80° C)	.035
Plastic	B-869 ToughWash Metal-Detectable Polypropylene	✓	-	-	Good	Good	175° F (80° C)	.098
Plastic	B-985 Photoluminescent polyester film on polystyrene	-	-	-	Good	Good	175° F (80° C)	.069

Custom Sign Pictograms (continued)



Custom Signs

BradyID.com/s36

Custom Sign Order Form

Order Quote Artwork Attached Ship Via. _____ P.O. # or Request # _____

Customer Information

Company Name: _____ Name: _____
Address1: _____ Phone #: _____
Address2: _____ Fax #: _____
City: _____ State: _____ Zip: _____
Email: _____

Distributor Information

Distributor: _____ Contact Name: _____
Account: _____ Fax #: _____ Phone #: _____

Sign Material

- B-120 Premium Fiberglass
- B-302 Self-Sticking Polyester
- B-324 Self-Sticking BradyGlo™
- B-347 BradyGlo™ Plastic
- B-401 Plastic
- B-555 Aluminum
- Other: B-_____ (View all sign materials on page 583)

Size and Quantity (H x W)

- 3.5 in. x 5 in. Qty. _____
- 4 in. x 6 in. Qty. _____
- 5 in. x 7 in. Qty. _____
- 7 in. x 10 in. Qty. _____
- 9 in. x 12 in. Qty. _____
- 10 in. x 14 in. Qty. _____
- 12 in. x 18 in. Qty. _____
- 14 in. x 20 in. Qty. _____
- 18 in. x 24 in. Qty. _____
- __ in. x __ in. Qty. _____

Sign Header

- 
- 
- 
- 
- 
- 
- 
- 
- 
- 

No Header (Fill in below)

Background Color: _____
Lower Text Color: _____
(Lower text will be black unless specified)

Pictogram # _____ (View Previous Page For Available Pictograms)

Finishing:

- No Holes
- 4 Corner Holes
- Foam Tape
- 2 Post Holes
- 2 Side Holes
- Other (Show placement in box)

Draw sign layout and text in box below:

Please Include The Following Three Items:

1. Header
2. Picto Placement (If applicable)
3. Finishing Hole Placement

Custom Signs and Accessories

Custom Tank and Vessel Signs Order Form

Please have a Safety Data Sheet (SDS) in hand to fill in the form. The SDS, supplied from your chemical manufacturer, must be up-to-date with GHS elements. All required label elements needed to fill this form out are found in sections 1-3 in your chemical SDS. Once complete, return this form to BradyUSAQuotes@BradyCorp.com or fax to 1-800-292-2289. (A proof will be provided.)

Customer Information

Company Name: _____ Name: _____
 Address 1: _____ Phone #: _____
 Address 2: _____ Fax #: _____
 City: _____ State: _____ Zip: _____
 Email: _____

Distributor Information

Distributor: _____ Contact Name: _____
 Account: _____ Fax #: _____ Phone #: _____

Sign Material

- B-120 Fiberglass
- B-302 Self-Sticking
- B-401 Rigid Plastic

Size and Quantity (H x W)

- 10 in. x 7 in. Qty. _____
- 14 in. x 10 in. Qty. _____
- 20 in. x 14 in. Qty. _____

Sign Format



Format 1



Format 2



Format 3

Sign Content (Use sections 1-3 of your chemical SDS)

Tank #: _____

Chemical Name: _____

Signal Word: _____
 (DANGER or WARNING)

Hazard Statements: _____
 Located on your Safety Data Sheet, please include H-Code if available. i.e. H100

Precautionary Statements/First Aid: _____
 Located on your Safety Data Sheet, please include P-Code if available. i.e. P100

Pictograms:

Located on your Safety Data Sheet, indicate pictogram number below:
 1 Minimum / Maximum 4

Diamond 1: _____ Diamond 3: _____

Diamond 2: _____ Diamond 4: _____



1. Corrosive 2. Severe Toxic 3. Explosive 4. Flammable 5. Environmental



6. Acute Toxic 7. Oxidizing 8. Gas Pressure 9. Health

NFPA Rating:

Health _____ Fire _____ Instability _____ Specific _____

HMIG Rating:

Health _____ Fire _____ Instability _____ Specific _____

Protective Equipment Required Pictograms:

Choose up to 6 icons.

PPE 1: _____ PPE 3: _____ PPE 5: _____

PPE 2: _____ PPE 4: _____ PPE 6: _____



A. Safety Glasses



B. Rubber Gloves



C. Face Shield



D. Chemical Goggles



E. S.C.B.A.



F. Dust Mask



G. Rubber Boots



H. Apron



I. Respirator



J. Chemical Suit



K. Boots/Gloves



L. Eyewash/ Shower

Additional Sign Content:

DOT Class: _____

DOT ID #: _____

CAS #: _____

Reach Authorization #: _____

Internal Reference #: _____

Chemical Manufacturer Name: _____

Chemical Manufacturer Address: _____

Emergency Contact Phone #: _____

Confined Space Entry Permit Required? Yes No

Sign Legend Index

BradyID.com/s36

Sign Legend Index

Legend Text	Header	Pg
Is Responsible For The Housekeeping In...	-	519
Volts	Peligro	436
Volts	Danger	424
Volts	Danger	474
Volts / Volts	Danger / Peligro	436
Volts Authorized Personnel Only	Danger	472
\$100 Fine	-	566
\$200 Fine	-	566
\$250 Fine	-	566
\$350 Fine	-	566
1, 1, 1, Trichloroethane	-	462
1.5 Blasting Agents D 1	-	463
1.6 Explosive N 1	-	463
10 Min Parking Admission And Discharge Onl...	-	560
13,200 Volts	Danger	472
15 Minute Parking	-	560
2 Hr Parking Electric Vehicles Only	-	565
2 Hr Parking Electric Vehicles Only...	-	565
2 Hr Vehicle Charging Only	-	565
2 Way Traffic Symbol	-	573
3 Causes Of Accidents I Didn't Think I Did...	-	548
440 Voltios	Peligro	436
440 Volts	Danger	472
440 Volts / 440 Voltios	Danger / Peligro	436
45 Min Vehicle Charging Only 7 Am-10 Pm	-	565
480 Volts	Danger	424
A		
A Careful Workman Is The Best Safety Devic...	Be Careful	553
A Careful Workman Is The Best Safety Devic...	Safety First	553
A Clean Place Is A Safe Place	-	519
A Clean Work Area Is A Safe Work Area	-	519
A Cluttered Area Is A Hazard Please Help...	-	519
A Fire Today No Job Tomorrow	Safety First	553
A.E.D.	-	499
Access At Side	-	566
Accessible	-	545
Accidents Are Avoidable Forget The Alibi	Think	553
Acetic Acid, Glacial	-	462
Acetone	-	462
Acetylene	Caution	448
Acetylene	Danger	450
Acetylene	-	462
Acetylene Empty Cylinders	-	457
Acetylene Flammable Gas No Smoking No Open...	-	457
Acetylene Full Cylinders	-	457
Acetylene No Smoking No Open Flames	-	457
Acetylene, Flammable.	Danger	424
Acid	Caution	448
Acid	Danger	450
Acid	Warning	456
Acid (w/ Ghs Picto)	Danger	450
Acid / Acido	Danger / Peligro	436
Acid Keep Away	Danger	450
Acid Unloading Area Authorized Personnel...	Danger	450
Acid Wear Proper Protection	Danger	450
Acid Wear Protective Equipment	Danger	450
Acid, Contact Will Result In Serious Burns...	Danger	424
Acid, Could Result In Moderate Injury.	Caution	420
Acid, Wear Proper Protection.	Danger	424
Acids	Danger	450
Acids, Contact Will Result In Severe Burns...	Danger	424
Acrylic Acid	-	462
Acrylonitrile (An) Cancer Hazard Authorize...	Danger	450
Acrylonitrile (An) May Cause Cancer...	Danger	450
Additional Parking In Rear	-	560
Administration	-	502
Admittance Limited To Authorized Personnel	Danger	413
Admittance Only To Personnel Working In...	Danger	413
Aerosols	-	544
After Using Extinguisher Return To Storero...	-	487
Agua No Potable	Aviso	440
Agua No Potable, No Apta Para Beber Ni Coc...	Aviso	440
Airborne Radioactivity Area	-	543
Alarm Secured Door Emergency Exit Use Only	-	487
Alarm Will Sound If Door Opens	Caution	412
All Drums In This Area Must Be Grounded	Notice	456
All Employees And Visitors Must Wear Eye...	Notice	536
All Employees And Visitors Must Wear...	Notice	555

Legend Text	Header	Pg
All employees must wash their hands before...	Notice	559
All Employees Whose Work Does Not Require...	Notice	415
All Injuries No Matter How Slight They May...	Notice	493
All Lunch Boxes, Packages, Bags, Purses,...	Notice	415
All Personnel Must Wear Safety Glasses...	Notice	536
All Through Traffic Use Designated Walk...	-	496
All Truck Drivers Must Sign In Before...	Notice	415
All Unauthorized Vehicles Will Be Towed...	-	556
All Vehicles And Personnel Entering Or...	Notice	571
All Vehicles Entering Or Leaving Subject...	Notice	555
All Vehicles Entering Or Leaving The...	Notice	415
All Visitors And Job Applicants Must Stop...	Notice	415
All Visitors Must Get Pass At Office	Notice	415
All Visitors Must Get Pass At Office	Restricted Area	555
All Visitors Must Register At Office	Notice	415
All Visitors Must Report To Security	Security Notice	555
All Visitors Report To Site Office	Notice	558
All Way	-	576
Alternative Medicine	-	502
Alto Voltaje	Peligro	436
Alto Voltaje No Entrar	Peligro	436
Aluminum Cans Only	-	544
Always Add Acid To Water	Caution (ANSI)	424
Always Keep Clear	-	562
Ambulance Entrance	-	502
Ambulance Parking Only	-	560
America And Safety First	-	548
America On Guard	-	557
Ammonia	Danger	450
Ammonium Hydroxide	-	462
And Start A Trend Here	Think	498
Anesthesia	-	502
Anhydrous Ammonia	Danger	450
Anhydrous Ammonia	-	462
Anhydrous Ammonia, Contact Will Result In...	Danger	424
Antifreeze	Danger	450
Any Time	-	562
Anyone Entering Tanks Must Wear Safety Bel...	Caution	466
Anyone Working Over This Area Shall Wear A...	Caution	466
Approach Door Slowly	Caution	412
Approach Slowly Gate Will Open	-	556
Arc Welding	Caution	420
Arc Welding	Caution	448
Area De Almacenamiento De Desechos Peligro...	Peligro	436
Area For Evacuation Assistance	-	487
Area For Rescue Assistance	-	487
Area In Front Of This Electrical Panel...	Caution	420
Area In Front Of This Electrical Panel...	Caution	472
Area In Front Of This Electrical Panel...	Caution	559
Area In Front Of This Electrical Panel...	Caution / Precaucion	434
Area In Front Of This Electrical Panel...	Danger	424
Area In Front Of This Electrical Panel...	Danger	472
Area In Front Of This Electrical Panel...	Danger / Peligro	437
Area In Front Of This Electrical Panel...	-	474
Area Of Refuge	-	487
Argon	Danger	450
Argon Be Back Later	Danger	498
Argon Empty Cylinders	-	457
Argon Full Cylinders	-	457
Arrow Left Picto	-	475
Arrow Picto (Floor Sign)	-	497
Arrow Pointing Left And Right Picto	-	573
Arrow Pointing Right	-	573
Arrow Pointing Upper Right	-	573
Arrow Right Down Picto	-	475
Arrow Right Picto	-	475
Arrow Right Up Picto	-	475
Arrow Up Picto	-	496
Arrow Up Picto (Glow)	-	496
Asbestos	-	544
Asbestos Cancer And Lung Disease Hazard...	Caution	448
Asbestos Cancer And Lung Disease Hazard...	Danger	424
Asbestos Cancer And Lung Disease Hazard...	Danger	450
Asbestos Cancer And Lung Disease Hazard...	Danger	558
Asbestos Dust Hazard Avoid Breathing Dust...	Caution	448
Asbestos Dust Hazard Cancer And Lung Disea...	Danger	450
Asbestos Hazard, Do Not Disturb Without...	Caution	420
Asbestos Hazardous Do Not Disturb Without...	Caution	448
Asbestos May Cause Cancer Causes Damage...	Danger	450

Sign Legend Index

BradyID.com/s36

Legend Text	Header	Pg
Asbestos Waste Disposal Site Do Not Create...	Caution	448
Asbestos, Cancer And Lung Disease Hazard...	Caution	420
Asbestos, Cancer And Lung Disease Hazard...	Danger	424
Asbestos, Hazardous, Do Not Disturb Without...	Caution	420
Asbestos, May Cause Cancer And Lung Damage...	Danger	424
Assembly Picto Only	-	484
Assembly Point	-	484
Assigned Parking Only	-	560
Atmosphere May Be Hazardous Follow Confine...	Caution	466
Attach Grounding Cables	Caution	420
Attach Grounding Cables	Caution	472
Attach Grounding Wire Clips	Caution	472
Attention All Visitors And Sales People...	-	571
Authorized Drivers Only Are Allowed To...	Notice	571
Authorized Employees Only	Restricted Area	416
Authorized Employees Only / Solo Empleados...	Restricted Area / Area Restringida	442
Authorized Parking Only	-	560
Authorized Personnel	-	417
Authorized Personnel Only	Caution	412
Authorized Personnel Only	Danger	413
Authorized Personnel Only	Notice	415
Authorized Personnel Only	Notice	432
Authorized Personnel Only	Restricted Area	555
Authorized Personnel Only	Warning	417
Authorized Personnel Only	Warning	432
Authorized Personnel Only	-	417
Authorized Personnel Only	-	560
Authorized Personnel Only / Solo Personal...	Danger / Peligro	439
Authorized Personnel Only / Solo Personal...	No Trespassing / Prohibida La Entrada	440
Authorized Personnel Only / Solo Personal...	Notice / Aviso	441
Authorized Personnel Only Beyond This Point	Danger	413
Authorized Personnel Only Check With Control...	Danger	413
Authorized Personnel Only Proper Id Require...	Restricted Area	417
Authorized Personnel Only Proper Safety...	-	417
Authorized Personnel Only	Caution	420
Authorized Personnel Only	Danger	424
Authorized Personnel Only	Warning	432
Authorized Personnel Only, Entering Could...	Caution	420
Authorized Personnel Only, Entering Could...	Danger	424
Authorized Personnel Only, Entering Could...	Warning	433
Authorized Use Only	Danger	510
Authorized Vehicles Only	-	560
Automatic Door Keep Clear	-	471
Automatic Equipment May Start At Anytime	Caution	506
Automatic Equipment Will Start At Any Time	Caution	506
Automatic Equipment Will Start Without...	Caution	506
Automatic Security Alarm Will Sound When...	Notice	470
Automatic Sprinkler System Sub Basement	-	487
Automatic Start Equipment	Danger	510
Avoid A Fall Use Handrails	-	516
Avoid A Fall Use Handrails / Evite Caidas...	-	442
Avoid Accidents Clean Up Spills	-	519
Avoid Backtalk Please Lift Properly	-	548
Avoid Breathing Chemical Vapors Use Protect...	Caution	448
Avoid Contamination Wash Your Hands	Warning	528
Avoid Contamination Wash Your Hands Before...	-	528
Avoid Contamination Wash Your Hands...	Notice	432
Avoid Injury Watch Your Step	Caution	529
Avoid Injury, Watch Your Step.	Caution	420
Ayuda A Mantener Esta Area Limpia	-	442
B		
Back In Or Pull Out On Green Only	Warning	571
Back-In Parking Only	-	560
Bad Planning On Your Part Does Not...	-	498
Barricade Area Do Not Enter Without...	Danger	413
Basement Not An Exit	-	475
Battery Charging Area No Smoking	Danger	522
Battery Charging Area No Smoking	Warning	523
Battery Charging Station No Smoking Or...	Caution	570
Battery Charging Station, No Smoking Or...	Caution	420
Battery Room Absolutely No Smoking Safety...	-	457
Be Alert Don't Get Hurt	-	554
Be Alert Moving Parts	Caution	506
Be Aware Of Moving Equipment	-	547
Be Aware Of Overhead Cranes	-	547
Be Aware Of Overhead Cranes And Avoid...	-	547
Be Careful	Safety First	553
Be Careful Carelessness Can Hurt You And...	-	548
Be Prepared To Stop	-	569
Be Safe Lock It Out	Caution	504

Legend Text	Header	Pg
Be Sure Cylinder Is Properly Supported And...	Warning	432
Be Sure Elevator Is Locked When Loading...	Caution	506
Be Sure Everyone Is Clear Before Starting...	Danger	510
Be Sure Safety Guards Work At All Times	Danger	510
Before Entering, Test For Explosive Atmosp...	Caution	412
Before Working On Any Machine, Be Positive...	Be Careful	504
Before You Act	Think	553
Before You Leave Please Clean Up!	-	519
Before You Leave... Take A Minute To Clean	-	519
Benzaldehyde	-	462
Benzene	Danger	450
Benzene	-	462
Benzene Cancer Hazard	Danger	450
Benzene Cancer Hazard Flammable-No Smoking...	Danger	450
Benzene Vapors	Caution	448
Beyond This Point You Are In The Presence...	Caution	420
Beyond This Point You Are In The Presence...	Caution	541
Bicycle Parking Only	-	560
Bike Lane	-	562
Billing Department	-	502
Bio Hazard / Riesgo Biologico	Danger / Peligro	439
Bio Hazard / Riesgo Biologico	-	444
Bio-Hazard Area	-	445
Biohazard	-	445
Biohazard (Floor Sign)	-	497
Biohazard Area	-	445
Biohazard Authorized Personnel Only...	Warning	445
Biohazard Authorized Personnel Only...	-	445
Biohazard Dispose Of Properly	-	445
Biohazard Infectious Agent Entry Require...	-	445
Biohazard Infectious Waste	-	445
Biohazard No Food Or Drink To Be Stored In...	-	445
Biohazard Universal Precautions Must Be...	-	445
Biological Hazard Authorized Personnel Only	Caution	445
Blank (Blue)	-	568
Blank (Red)	-	568
Blank Sign	Advertencia	446
Blank Sign	Area Restringida	446
Blank Sign	Aviso	446
Blank Sign	Be Careful	446
Blank Sign	Caution	446
Blank Sign	Danger	446
Blank Sign	Notice	446
Blank Sign	Peligro	446
Blank Sign	Precaucion	446
Blank Sign	Radiation	446
Blank Sign	Restricted Area	446
Blank Sign	Safety First	446
Blank Sign	Warning	446
Blank Sign	-	446
Blank Sign	-	543
Blasting Keep Away	Danger	486
Blasting Keep Away	Warning	469
Blind Corner Proceed With Caution	-	573
Bloquear Los Manubrios Electricos Antes...	Peligro	436
Body Harness Required For Entry	Danger	424
Body Harness Required For Entry	Danger	534
Boiler Room Authorized Personnel Only	Danger	413
Books	-	544
Boots Must Be Worn	-	538
Boys	-	545
Braille Sign Frame	-	447
Breakers Locked Out	Danger	504
Breathing Air Emergency Use Only	Notice	493
Breathing Air Empty Cylinders	-	458
Breathing Air Full Cylinders	-	458
Breathing Air Station	Notice	493
Breathing Apparatus	-	499
Breathing Apparatus Keep Area Clear...	Safety First	432
Breathing Apparatus Required	Caution	529
Breathing The Air In This Parking Garage Can...	Warning	461
Breathing The Air In This Smoking Area Can...	Warning	461
Bromine	-	462
Buckle Up And Drive Safely	-	573
Buckle Up It Could Save Your Life	-	573
Buckle Up! It's The Law	-	573
Buddy System Is Required For Entry	Caution	466
Buddy System Must Be Used For Entry Into...	Danger	466
Building Materials	-	544
Bump	-	573
Bump Caps Must Be Worn In This Area	Caution	420
Bump Caps Must Be Worn In This Area	Caution	529

Sign Legend Index

BradyID.com/s36

Legend Text	Header	Pg
Bump Caps Must Be Worn In This Area.	Caution	420
Buried Cable	Caution	472
Buried Cable	Danger	472
Buried Cable Call Before Digging	Caution	472
Buried Cable, Proceed With Caution, Contac...	Danger	424
Buried Electric Line Below	Caution	472
Buried Gas Line	Caution	469
Buried Pipeline	Caution	448
Butane	-	462
Butanol	-	462
C		
Cable Buried Here	Danger	473
Cable Buried Here, Contact Will Result In...	Danger	424
Cadmium May Cause Cancer Causes Damage...	Danger	450
Calcium Chloride	-	462
Calcium Hypochlorite	-	462
Caliente	Peligro	437
California Proposition 65 Warning Diesel E...	-	461
Cameras Not Allowed	-	556
Cancer Hazard Authorized Personnel Only No...	Danger	451
Cancer Suspect Agent Area Protective Equip...	-	458
Capacity ___ Lbs / Capacidad: ___ Kg	Caution / Precaucion	434
Capacity ___ Lbs	Caution	518
Capacity Tons	-	519
Car Pool Parking Only	-	560
Carbon Dioxide	Danger	451
Carbon Dioxide	-	462
Carbon Dioxide Gas Can Cause Injury Or Death...	Caution	460
Carbon Dioxide Gas Can Cause Injury Or Death...	Warning	460
Carbon Dioxide Gas Discharge Into Nearby...	Caution	460
Carbon Disulfide	-	462
Carbon Monoxide Area Requires Proper...	Caution	448
Carbon Monoxide May Be Present	Caution	448
Carbon Monoxide May Be Present	Danger	451
Carbon Monoxide May Be Present, Wear...	Caution	420
Carbon Monoxide May Be Present, Wear...	Danger	424
Carbon Tetrachloride	-	462
Cardboard Only	-	544
Cardiology	-	502
Cardiology Parking Only	-	560
Care Staff Area	-	502
Carry It Low - Drive It Slow	-	548
Carrying Concealed Deadly Weapons Is...	-	521
Cartons	-	544
Cat Scan	-	502
Cath Lab	-	502
Causes Of Accidents: 1 I Didn't Think...	-	554
Caustic	Danger	451
Caustic Chemical Goggles Must Be Worn...	Caution	448
Caustic In Use Wear Protective Equipment	Danger	451
Caustic Overhead	Danger	451
Caustic Potash (Potassium Hydroxide)	-	462
Caustic Soda (Sodium Hydroxide)	-	462
Caustic Soda Avoid Skin Or Eye Contact...	Caution	448
Caustic Unloading Area Authorized Personnel...	Danger	451
Caustic Wear Protective Equipment	Danger	451
Caustic, Will Cause Severe Burns, Injury...	Danger	424
Caution - Propane	-	458
Caution (3 Pocket With Grommets)	-	542
Caution (5 Pocket With Grommets)	-	542
Caution (With Stripes)	-	516
Caution Automatic Door	-	471
Caution Biohazard	-	445
Caution Biological Hazard	-	445
Caution Children At Play	-	573
Caution Door Swings Out	-	499
Caution Drive Slowly	-	573
Caution Eye Protection Required In This...	-	499
Caution High Level Radio Frequency Energy...	-	542
Caution High Radiation Area	-	542
Caution Laser Invisible Beam	-	542
Caution Lock Out Radiation Source Before...	-	543
Caution Radiation Area	-	496
Caution Radiation Area	-	542
Caution Radiation Area Authorized Entry On...	-	542
Caution Radiation Area Keep Out	-	542
Caution Radiation Area Radioactive Materia...	-	542
Caution Radioactive Material	-	542
Caution Radioactive Materials	-	542
Caution Slippery Surface	-	433
Caution Speed Bump	-	573
Caution This Equipment Produces Ionizing...	-	542

Legend Text	Header	Pg
Caution Wet Floor	-	433
Caution X-Rays This Equipment Produces X-Ray...	-	542
Caution! Automatic Gates No Playing Or...	-	573
Certain Dental Procedures Performed In This...	Warning	461
Certain Food And Beverages Sold Or Served...	Warning	461
Chain All Cylinders Securely	Notice	456
Changeable Arrow	-	487
Chapel	-	502
Check Battery Acid Before Connecting Charge...	Caution (ANSI)	448
Chemical Goggles Must Be Worn Beyond This...	Notice	536
Chemical Goggles Required	-	458
Chemical Goggles Required In This Area	Caution	420
Chemical Goggles Required In This Area	Caution	529
Chemical Goggles Required In This Area.	Caution	420
Chemical Lines Overhead	Caution	448
Chemical Spillage Must Be Reported Immedia...	-	458
Chemical Spills Must Be Reported Immediate...	Notice	456
Chemical Storage	Danger	425
Chemical Storage	Danger	451
Chemical Storage (Floor Sign)	-	497
Chemical Storage / Almacenamiento De Susta...	Danger / Peligro	436
Chemical Storage Area	Warning	456
Chemical Storage Area	-	496
Chemical Storage Area / Area Para Almacena...	Caution / Precaucion	434
Chemical Waste Storage Area Unauthorized...	Danger	451
Chlorine	Danger	451
Chlorine	-	462
Chlorine / Cloro	Danger / Peligro	437
Chlorine Area	Caution	448
Chlorine Area, Hazardous Contact May Result...	Caution	420
Chlorine Gas	Danger	451
Chlorine Gas, Breathing Gas Will Result In...	Danger	425
Chlorine, Contact Will Cause Burns Or Severe...	Danger	425
Chloroform	-	462
Chromic Acid, Solid Chromium Anhydride	-	462
Church Parking Only	-	560
Clean And Store Respirator After Use	Notice	536
Clean Empty Drums	-	458
Clean Equipment After Use	Notice	514
Clean Machine At The End Of Each Shift	Notice	514
Clean Up After Your Dog Dog Waste Transmit...	-	544
Clean Up And Keep Clean	-	519
Clearance ___ Ft	Notice	514
Clearance ___ Ft ___ In	Caution	420
Clearance ___ Ft ___ In	Caution	506
Climb Ladders Slowly And Use Both Hands	Safety First	515
Close Clearance	Caution	570
Close Clearance	Danger	510
Close Door When Not In Use	Caution	470
Closed Area Authorized Personnel Only	-	417
Clothing Contaminated With Lead	Caution	448
Coke Oven Emissions May Cause Cancer Do No...	Danger	451
Combustible	Danger	451
Combustible 3	-	464
Combustible Diesel	Peligro	437
Combustible Dust	Warning	456
Combustible Dust Area No Smoking Or Open...	Danger	522
Combustible Dust No Smoking, Welding Or...	Danger	522
Combustible Liquids	Danger	451
Combustible Liquids (w/ Ghs Picto)	Danger	451
Combustible Liquids.	Danger	425
Compact Cars Only	Notice	560
Company Is Not Responsible For Loss Or Damage...	Notice	561
Company Phones Are For Business Only No...	-	516
Complaint Department 100 Miles	Notice	498
Compressed Air	Caution	448
Compressed Air	Danger	451
Compressed Air Do Not Use For Blowing Off...	Danger	451
Compressed Air Do Not Use For Cleaning	Danger	451
Compressed Air Lock Out Source And Bleed...	Warning	505
Compressed Air, Do Not Use For Blowing Off...	Danger	425
Compressed Air, Improper Release Could...	Caution	420
Compressed Gas	Danger	451
Concealed Firearms Are Prohibited In This...	Security Notice	521
Confined Space	Danger	425
Confined Space	Danger	466
Confined Space Air-Supplied Respirator...	Danger	466
Confined Space Authorized Personnel Only	Danger	425
Confined Space Authorized Personnel Only...	Danger	425
Confined Space Call ___ Before...	Danger	466
Confined Space Call Your Supervisor	Danger	468
Confined Space Class ___ Permit Required...	Caution	466
Confined Space Class ___ Permit Required...	Caution	466

Sign Legend Index

BradyID.com/s36

Legend Text	Header	Pg
Confined Space Do Not Enter Without Obtain...	Caution	466
Confined Space Do Not Enter Without Obtain...	Caution	468
Confined Space Do Not Enter Without Permitt...	Danger	466
Confined Space Do Not Enter Without Proper...	Danger	467
Confined Space Enter All Tanks By Permitt...	Danger	467
Confined Space Enter By Permit Only	Caution	466
Confined Space Enter By Permit Only	Danger	425
Confined Space Enter By Permit Only	Danger	454
Confined Space Enter By Permit Only	Danger	467
Confined Space Enter By Permit Only	Danger	468
Confined Space Enter By Permit Only / Area...	Danger / Peligro	436
Confined Space Enter By Permit Only Prepar...	Danger	467
Confined Space Enter By Permit Only...	Danger	425
Confined Space Enter By Permit Only...	Danger	467
Confined Space Entry Can Be Fatal Entry By...	Danger	467
Confined Space Entry Can Be Fatal Follow...	Danger	468
Confined Space Entry Permit Required #	Danger	467
Confined Space Entry Permit Required Call...	Caution	466
Confined Space Entry Permit Required Call...	Danger	468
Confined Space Follow Entry Procedures # ...	Danger	467
Confined Space Hazardous Atmosphere Entry...	Danger	467
Confined Space Hazardous Atmosphere...	Danger	454
Confined Space Hazardous Atmosphere...	Danger	467
Confined Space Keep Out	Danger	467
Confined Space Keep Out Unless Authorized	Danger	425
Confined Space Keep Out Unless Authorized	Danger	467
Confined Space Keep Out Unless Authorized...	Danger / Peligro	437
Confined Space Lock Out And Tag Out Require...	Danger	425
Confined Space Lock Out And Tag Out Require...	Danger	467
Confined Space Lock-Out & Tag-Out Procedure...	Danger	467
Confined Space No Smoking, Matches Or Open...	Danger	467
Confined Space No Entry Permit Required...	Caution	412
Confined Space Permit Not Required	Danger	468
Confined Space Permit Required	Danger	468
Confined Space Permit Required For Entry	Danger	468
Confined Space Permit Required Unauthorized...	Danger	468
Confined Space Procedures Must Be Followed	Caution	466
Confined Space Trained Personnel Only	Caution	466
Confined Space Use Lockout And Entry...	Caution	466
Confined Space Use Lockout And Entry...	Caution / Precaucion	434
Confined Space Ventilate Before Entering	Danger	468
Confined Space.	Danger	425
Confined Space. Authorized Personnel Only.	Danger	425
Confined Space. Enter By Permit Only.	Danger	425
Confined Space. Enter by permit only.	Danger	559
Confined Space. Enter By Permit Only...	Danger	425
Confined Space. Entering Without Training...	Danger	425
Confined Space. Keep Out Unless Authorized...	Danger	425
Confined Space. Lock Out And Tag Out Required...	Danger	425
Connect Ground Wire Before Using	Caution	472
Conserve Water	-	544
Construction Ahead	-	569
Construction Area	Danger	469
Construction Area / Area De Construccion	Danger / Peligro	436
Construction Area Authorized Personnel...	Caution	412
Construction Area Authorized Personnel...	-	469
Construction Area Keep Out	Danger	469
Construction Area Keep Out / Area De Const...	Danger / Peligro	436
Construction Area. Keep Out.	Danger	425
Construction Area. Keep Out. Entering Could...	Danger	425
Construction Entrance	-	469
Construction In Progress	Caution	469
Construction Parking	-	558
Construction Personnel Only	Danger	469
Construction Site Keep Out	Danger	558
Construction Site No Trespassing	Danger	558
Construction Site No Trespassing	Notice	415
Construction Site Unauthorized Persons...	Danger	558
Construction Zone Unauthorized Personnel...	Danger	469
Construction Zone. Unauthorized Personnel...	Danger	425
Contact Will Cause Electrocution Or Death	Danger	426
Contains Asbestos Fibers Avoid Creating...	Danger	425
Contains Asbestos Fibers Avoid Creating...	Danger	451
Contains Asbestos Fibers Avoid Creating...	Danger / Peligro	437
Contains Benzene Cancer Hazard	Caution	448
Contains Cadmium Poisonous Fumes May Be...	Warning	457
Contains Ethylene Oxide Cancer Hazard And...	Danger	451
Contains Fluorides	Caution	448
Contains Hazardous Material See Msds File	Caution	448
Contaminated Water	Danger	451
Contamination In System	-	543
Contents Under Extreme Pressure Handle...	Danger	451
Contractor Parking	-	560

Legend Text	Header	Pg
Control Room	-	471
Controlled Access Zone	Danger	413
Conveyor May Start Without Warning	Caution	506
Conveyor May Start Without Warning / La Ba...	Caution / Precaucion	434
Cooked Meat Only	-	516
Corrosive	Danger	451
Corrosive	-	458
Corrosive 8	-	464
Corrosive Liquids Wear Acid Gloves And...	Danger	451
Corrosive Liquids Wear Protective Equipment	Danger	451
Corrosive Materials	Caution	448
Corrosive Materials (w/ Ghs Picto)	Danger	451
Corrosive Materials Wear Protective Clothing	Warning	457
Corrosive Materials Wear Required Protection	Caution	448
Corrosive Materials Wear Required Protection...	Caution / Precaucion	434
Corrosive Materials. Wear Proper Protection...	Caution	420
Corrosive Materials. Wear Required Protection...	Caution	420
Corrosive Picto 8	-	464
Corrosive. Contact Will Cause Burns Or...	Danger	425
Corrosives Avoid Contact With Eyes And...	Danger	425
Cotton Dust Causes Damage To Lungs...	Danger	451
Cotton Dust Work Area May Cause Acute Or...	Warning	457
Cpr Station	-	499
Crane Overhead	Danger	510
Crane Overhead / Grua Aerea	Danger / Peligro	438
Crane Overhead Proceed With Caution	Danger	425
Crane Swing	Danger	510
Crane Working Overhead	Danger	510
Cross On Green Light Only	-	573
Cross Only At Cross Walks	-	573
Crossing Or Standing On Conveyor Is Forbid...	Danger	510
Crosswalk Picto	-	575
Crude Oil, Gasoline, Diesel Fuel and Other Petroleum...	Warning	461
CT	-	502
Cuidado Con La Salida De Camiones	Precaucion	434
Customer Parking	-	560
Customer Parking Unauthorized Cars Will Be...	-	561
Customer Pick-Up	-	573
Customers Not Permitted In Working Area	Notice	415
Cut / Sever	-	516
Cutting And Welding Permit Required In This...	Caution	506
Cyanide	Danger	451
Cylinder Storage Area	-	458
Cylinders Contain Explosive Gas Handle Wit...	Danger	452
Cylinders Must Be Secured	Danger	452
Cylinders Not Connected Must Be Capped	Notice	456

D	Header	Pg
Damaging Or Defacing Company Property Will...	-	556
Danger Automatically Controlled May Start...	-	516
Danger High Radiation Area Authorized...	-	543
Danger High Voltage	-	474
Danger High Voltage Cable Buried Here	-	474
Danger Laser Light	-	543
Danger Moving Machinery	-	516
Danger No Trespassing Positively No Admitt...	-	417
Danger-Acids Wear Goggles Avoid Fumes And...	-	458
Dangerous	-	464
Dangerous When Wet 4	-	464
Debe Haber Un Espacio De 1M Delante De...	Peligro	437
Debe Haber Un Espacio De 1M Delante De...	Precaucion	434
Deep Excavation	Danger	558
Deliveries In Rear	-	571
Demolition Work In Progress	Danger	558
Dental	-	502
Deposit All Rubbish In Receptacles Provide...	Please	519
Deposit Matches And All Smoking Material...	-	524
Deposit Waste Here	Notice	518
Derail (Blue)	-	568
Derail (Red)	-	568
Dermatology	-	502
Designated Smoking Area	Notice	527
Designated Smoking Area	-	527
Designated Smoking Eating & Drinking Area	-	527
Designated Smoking Room	-	527
Designated Work Area Select Carcinogens Re...	Caution	448
Detectable Amounts Of Chemicals Known To...	Warning	461
Detour Ahead	-	569
Diabetes Education	-	502
Diagonal Parking	-	561
Dial 911 In Case Of Emergency	Safety First	493
Did You Remember To Remove Your Locks And...	-	505

Sign Legend Index

BradyID.com/s36

Legend Text	Header	Pg
Did You Wash Them? Hand Washing Stops The...	-	528
Diesel	Danger	452
Diesel Fuel	Danger	452
Diesel Fuel	-	462
Diesel Fuel / Gasoleo	Danger / Peligro	438
Diesel Fuel No Smoking In This Area	-	524
Diesel Fuel No Smoking No Open Flames	Danger	452
Diesel Fuel No Smoking No Open Flames...	Danger / Peligro	437
Diesel Fuel, Flammable	Danger	425
Diesel Fuel, No Smoking, No Open Flames...	Danger	425
Diesel No Smoking	Danger	522
Diesel Only	-	458
Diesel, Flammable	Danger	425
Diesel, No Smoking	Danger	425
Disconnect Power Supplies And Lock Out...	Caution	504
Do It Right The First Time! Plan Ahead	Think	498
Do Not Alter Or Move Scaffold While In Use	Danger	469
Do Not Attempt To Adjust Machinery While...	Caution	506
Do Not Block	-	573
Do Not Block Door	Notice	470
Do Not Block Door	Warning	471
Do Not Block Door / No Obstruir La Puerta	Notice / Aviso	441
Do Not Block Doorway	-	471
Do Not Block Driveway 24 Hour Access Require...	-	573
Do Not Block Keep Clear At All Times	-	471
Do Not Climb On Or Jump Off Dock	-	571
Do Not Climb Over This Enclosure Contains...	Danger	473
Do Not Deposit Sanitary Napkins In Toilet...	Notice	518
Do Not Discard Trash Of Any Kind In Toilet...	-	443
Do Not Discard Trash Of Any Kind In Toilet...	-	545
Do Not Drink The Water	Warning	457
Do Not Drink This Water	Danger	452
Do Not Drink This Water / No Beber Esta...	Danger / Peligro	438
Do Not Drive On Tracks	-	573
Do Not Dump Chemicals Down This Drain	Notice	456
Do Not Dump Chemicals Solvents Or Oils Dow...	Warning	457
Do Not Enter	Caution	412
Do Not Enter	Caution	420
Do Not Enter	Caution	470
Do Not Enter	Danger	413
Do Not Enter	Danger	558
Do Not Enter	Notice	415
Do Not Enter	Restricted Area	555
Do Not Enter	Warning	417
Do Not Enter	-	417
Do Not Enter	-	496
Do Not Enter	-	556
Do Not Enter	-	573
Do Not Enter (Floor Sign)	-	497
Do Not Enter / No Entrar	Caution / Precaucion	435
Do Not Enter / No Entrar	Danger / Peligro	438
Do Not Enter / Out	-	471
Do Not Enter Area Unless Wearing Proper...	Notice	536
Do Not Enter Authorized Personnel Only	Danger	413
Do Not Enter Authorized Personnel Only	Warning	417
Do Not Enter Authorized Personnel Only / Nn Entrar...	Danger / Peligro	439
Do Not Enter Authorized Personnel Only...	Restricted Area	555
Do Not Enter Chemicals In Use	Danger	452
Do Not Enter Emergency Exit Only	Danger	413
Do Not Enter Emergency Exit Only	Danger	475
Do Not Enter Hazardous Area Authorized Per...	Danger	452
Do Not Enter Test In Progress	Danger	413
Do Not Enter Truck Or Trailer With Forklif...	Danger	570
Do Not Enter Unless Wearing Safety Equipment	Safety First	417
Do Not Enter Unless Wheels Are Chocked	Be Careful	570
Do Not Enter Until Lockout Procedures Are...	Danger	425
Do Not Enter Until Lockout Procedures Are...	Danger	504
Do Not Enter When Equipment Is Operating	Danger	413
Do Not Enter When Equipment Is Operating...	Danger / Peligro	439
Do Not Enter When Light Is On	Caution	412
Do Not Enter When Lights Are Flashing	Danger	413
Do Not Enter When Red Light Is On	Danger	413
Do Not Enter While Machinery In Motion	Caution	412
Do Not Enter While Machinery In Motion...	Caution	420
Do Not Enter Without A Confined Space Permit	Caution	412
Do Not Enter Without A Confined Space Permit...	Caution	420
Do Not Enter Without Wearing Ear Protectio...	Caution	421
Do Not Enter Without Wearing Ear Protectio...	Danger	413
Do Not Enter Without Wearing Ear Protectio...	Danger	426
Do Not Enter Without Wearing Ear Protectio...	Danger	534
Do Not Enter Without Wearing Eye And Ear...	Caution	412
Do Not Enter Without Wearing Eye Protection	Caution	529
Do Not Enter Without Wearing Eye Protection...	Caution	421

Legend Text	Header	Pg
Do Not Enter Without Wearing Hard Hat	Danger	534
Do Not Enter Without Wearing Hard Hat....	Danger	426
Do Not Enter Without Wearing Protective...	Danger	413
Do Not Enter Without Wearing Safety Glasses	Danger	534
Do Not Enter Without Wearing Safety Glasses...	Danger	426
Do Not Enter	Caution	420
Do Not Enter	Danger	425
Do Not Enter	Warning	432
Do Not Enter, Authorized Personnel Only	Danger	425
Do Not Enter, Permit-Required Confined Space...	Danger	426
Do Not Exit / Enter	-	471
Do Not Handle Without Wearing Safety Shield...	Danger	426
Do Not Handle Without Wearing Safety Shield...	Danger	534
Do Not Leave Machine Unattended	Notice	514
Do Not Litter Place All Refuse In Trash...	-	519
Do Not Litter Please Use Containers Provide...	-	519
Do Not Litter! Please Put Cigarette Butts...	-	544
Do Not Look At Electric Arc It Will Hurt...	Danger	534
Do Not Look At Electric Arc, It Will Hurt...	Danger	426
Do Not Look At The Electric Arc, It Will H...	Danger	426
Do Not Obstruct Fire Apparatus	-	487
Do Not Oil Or Clean Machinery While In...	Safety First	515
Do Not Open Alarm Will Sound	Caution	412
Do Not Open Door Alarm Will Sound	-	487
Do Not Open This Door	Danger	470
Do Not Operate	Danger	504
Do Not Operate Closer Than 20 Feet To Power...	Danger	510
Do Not Operate Controls While This Sign Is...	Danger	510
Do Not Operate Machine Under Repair	Caution	506
Do Not Operate Machine Without Guards...	Warning	515
Do Not Operate Man Working On Repairs	Caution	506
Do Not Operate Men Working On Repairs	Danger	510
Do Not Operate This Equipment Without Ear...	Notice	536
Do Not Operate This Machine Without Guards...	Caution	421
Do Not Operate This Machine Without Guards...	Caution	506
Do Not Operate This Machine Without Guards...	Danger	421
Do Not Operate When Wearing Gloves Or Loos...	Caution	506
Do Not Operate When Wearing Gloves Or Loos...	-	516
Do Not Operate Without Eye Protection	Caution	529
Do Not Operate Without Eye Protection	-	538
Do not operate without eye protection, May cause...	Caution	559
Do Not Operate Without Eye Protection, May...	Caution	421
Do Not Operate Without Guards	Caution	421
Do Not Operate Without Guards	Caution	506
Do Not Operate Without Guards	-	516
Do Not Operate Without Guards In Place...	Danger	426
Do Not Operate Without Guards In Place...	Danger	510
Do Not Operate Without Guards In Place...	Danger / Peligro	439
Do Not Operate Without Guards Machines...	Caution	421
Do Not Operate Without Wearing Goggles	Danger	534
Do Not Operate Without Wearing Goggles...	Danger	426
Do Not Operate, Activation Will Result In...	Danger	426
Do Not Park Here	Notice	560
Do Not Park In Driveway	Notice	560
Do Not Park In Front Of Door	Notice	470
Do Not Park In Front Of Door	-	561
Do Not Park In Front Of Dumpster	-	561
Do Not Pass	-	574
Do Not Perform A Confined Space Rescue...	Danger	468
Do Not Play On Or Around	Caution	506
Do Not Pour Chemicals Down The Drain	Caution	449
Do Not Put Hands Or Fingers Into Or Under...	Danger	510
Do Not Put On Or Take Off Belts While Mach...	Safety First	515
Do Not Put Your Hands In This Press Under...	Caution	506
Do Not Raise Gate Until The Elevator Has...	Danger	510
Do Not Reach Into Running Equipment	Caution	506
Do Not Remove Guards Or Operate Machinery...	Warning	433
Do Not Remove Guards Or Operate Machinery...	Warning	515
Do Not Ride On The Elevator It Is For Freight...	Notice	514
Do Not Ride This Vehicle	Danger	510
Do Not Scatter Paper And Trash On Floors...	Think	519
Do Not Smoke Eat Or Drink In This Area	Caution	522
Do Not Smoke In This Area	Notice	432
Do Not Smoke, Eat Or Drink In This Area...	Notice	432
Do Not Stack To Within 18 Of Sprinkler Pipe...	-	487
Do Not Stand Here	Danger	510
Do Not Stand In Front Of Machine While...	Danger	510
Do Not Start	Caution	504
Do Not Start Engine	Danger	510
Do Not Start Machine Being Repaired	Danger	510
Do Not Start Machine Being Repaired / No...	Danger / Peligro	438
Do Not Start This Machine	Danger	510
Do Not Start This Machine	Warning	515

Sign Legend Index

BradyID.com/s36

Legend Text	Header	Pg
Do Not Stop On Tracks	-	574
Do Not Talk To Operator	Caution	506
Do Not Talk To Operator	Notice	514
Do Not Talk To Operator While Machine Is...	Danger	510
Do Not Talk To Operators To Distract Their...	Safety First	515
Do Not Throw Any Rubbish Or Waste In Toilet	Notice	518
Do Not Throw Paper Towels In Toilet	Please	519
Do Not Touch Out Of Order	Danger	511
Do Not Touch Switches	Danger	473
Do Not Unload Without Full Protective Gear	Danger	534
Do Not Use	Danger	511
Do Not Use Hands To Clean This Machine	Danger	511
Do Not Use On Electrical Fires	Caution	472
Do Not Use This Equipment	Warning	515
Do Not Use Water On Fires In This Area	-	487
Do Not Walk On Conveyors	Caution	529
Do Not Walk On Conveyors. Fall Will Result...	Caution	421
Do Not Watch Arc	Caution	472
Do Not Watch Arc	Caution	529
Do Not Watch Arc Welder At Work The Light...	Danger	511
Do Not Watch Arc Welder At Work The Light...	Danger	534
Do Not Watch Arc Welder At Work. The Light...	Danger	426
Do Not Watch Arc. Vision Damage May Occur.	Caution	421
Do Not Watch The Arc	Danger	511
Do Not Watch The Arc. Severe Vision Damage...	Danger	426
Do Not Wear Gloves While Operating This...	Caution	421
Do Not Wear Gloves While Operating This...	Caution	529
Do Not Wear Jewelry, Loose Clothing Or...	Caution	506
Do Not Wear Loose Clothing While Operating...	Caution	506
Do You Want To Talk To The One In Charge...	Notice	498
Dog Waste Transmits Disease Contaminates...	-	544
Don't Clean Or Repair Machinery While In...	Danger	511
Don't Forget Lock Out Tag Out	-	548
Don't Have An Accident	-	548
Don't Start Out Of Order	Danger	511
Don't Take Chances Others Are Depending On...	Think	553
Don't Try To Lift More Than You Are Able	Safety First	553
Don't Be A Litterbug Use Receptacles	-	519
Don't Even Think About Smoking In This Area	-	524
Don't Even Think Of Parking Here	-	561
Don't Pass It Up...Pick It Up!	-	520
Door Alarmed Open Only For Emergency Exit	Notice	470
Door For Emergency Use Only	Notice	470
Door Opens Outward	Caution	412
Door Swings Inward	Caution	470
Dose Rate At This Point Is Mr/Hr Date...	-	543
Dose Rate Mr/Hr Special Instructions Co...	-	543
Double Hearing Protection Required In This...	Caution	421
Double Hearing Protection Required In This...	Caution	529
Down Time Is Clean Up Time	-	520
Drilling, Sawing, Sanding Or Maching Wood...	Warning	461
Drinking Distilled Spirits, Beer, Coolers, Wine and...	Warning	461
Drinking Water	Notice	518
Drive Slowly	Danger	571
Drive Slowly Accident Will Result In Severe...	Danger	426
Drivers Chock Both Wheels	-	571
Drivers Chock Wheels And Turn Off Engine...	-	571
Drivers Must Report Inside	-	417
Drivers Restricted To Truck Loading Dock...	Notice	571
Drum Storage Rules All Drums Must Be Secure...	-	458
Drums Must Be Labeled	Notice	456
Ducha De Emergencia Y Para Lavado De Ojos	-	442
Dust Mask Is Required	Caution	529
Dust Mask Is Required. Breathing Unfiltered...	Caution	421
Dust Masks Are Required At All Times	-	547
Dust Masks Are Required In This Area	-	547
Dust Respirator Must Be Worn On This Job	Notice	536
E		
Ear And Eye Protection Area	Caution	529
Ear And Eye Protection Area. Failure May...	Caution	421
Ear Hazard Area Ear Protection Required At...	Caution	529
Ear Hazard Area. Ear Protection Required...	Caution	421
Ear Plugs Must Be Worn In This Area	Caution	529
Ear Plugs Must Be Worn In This Area. Failure...	Caution	421
Ear Protection Area	Danger	534
Ear Protection Area	-	496
Ear Protection Area (Floor Sign)	-	497
Ear Protection Area / Area De Proteccion...	Danger / Peligro	436
Ear Protection Area. Severe Hearing Damage...	Danger	426
Ear Protection Is Available See Your Super...	Safety First	537
Ear Protection Must Be Worn	-	538
Ear Protection Must Be Worn Beyond This Po...	Notice	536

Legend Text	Header	Pg
Ear Protection Must Be Worn In This Area	Caution	529
Ear Protection Must Be Worn In This Area	Danger	534
Ear protection must be worn in this area. Moderate...	Caution	559
Ear Protection Must Be Worn In This Area...	Caution	421
Ear Protection Must Be Worn In This Area...	Danger	426
Ear Protection Must Be Worn In This Area...	Notice / Aviso	440
Ear Protection Must Be Worn In This Area...	-	538
Ear Protection Must Be Worn In This Plant	Caution	529
Ear Protection Must Be Worn While Working...	Notice	536
Ear Protection Picto	-	538
Ear Protection Picto	-	539
Ear Protection Required	Caution	530
Ear Protection Required	Danger	534
Ear Protection Required / Se Requiere...	Danger / Peligro	439
Ear Protection Required At All Times	Danger	534
Ear Protection Required Beyond This Point	-	539
Ear Protection Required In This Area	Notice	536
Ear Protection Required In This Area	Warning	538
Ear Protection Required In This Area / En...	Caution / Precaucion	434
Ear Protection Required In This Area...	Caution	530
Ear Protection Required When Operating	Caution	530
Ear Protection Required When This Equipment...	Caution	530
Ear Protection Required While Equipment Is...	Warning	538
Ear Protectors Required When In This Area...	Notice	536
Ear, Nose & Throat	-	502
Eating And Drinking Permitted Only In The...	-	520
Eating, Drinking, And Smoking Prohibited	-	543
Efficiency Requires Cleanliness And Order	Notice	514
Electric Current Keep Away	Danger	473
Electric Fence	Danger	413
Electric Fence / Cerca Electricada	Danger / Peligro	437
Electric Meter Room No Storage	Danger	473
Electric Spark Hazard No Cell Phones	Warning	474
Electric Vehicle Charging Station	-	565
Electrical	-	544
Electrical Box Covers Must Be Closed At Al...	Danger	426
Electrical Box Covers Must Be Closed At Al...	Danger	473
Electrical Closet No Storage Permitted	Notice	474
Electrical Closet No Storage Permitted	-	474
Electrical Equipment Authorized Personnel...	Danger	414
Electrical Equipment Authorized Personnel...	Danger	426
Electrical Equipment Authorized Personnel...	Danger	473
Electrical Equipment Authorized Personnel...	Danger / Peligro	437
Electrical Equipment Authorized Personnel...	-	474
Electrical Hazard	Danger	473
Electrical Hazard Authorized Personnel Onl...	Danger	414
Electrical Hazard Authorized Personnel Onl...	Warning	417
Electrical Hazard Authorized Personnel Onl...	Warning	433
Electrical hazard. Authorized personnel only. Serious...	Warning	559
Electrical Picto	-	474
Electrical Room No Storage Permitted	Danger	426
Electrical Room No Storage Permitted	Danger	473
Electrical Room No Storage Permitted / Cua...	Notice / Aviso	440
Electrical Shock Hazard Do Not Touch	Danger	473
Electrical Supply Station Danger All Unaut...	-	417
Electricians Only	Danger	473
Electricity Picto	-	474
Elevator (Braille w/Picto)	-	447
Elevator Out Of Order	Notice	514
Elevator Shaft	Danger	511
Eliminate Doubt Lock It Out	Caution	504
Emergency	-	502
Emergency And Authorized Vehicles Only	-	574
Emergency Assembly Point	-	484
Emergency Breathing Apparatus Inside	-	494
Emergency Conveyor Stop	-	516
Emergency Door	-	475
Emergency Equipment w/Picto	-	475
Emergency Evacuation Point	-	475
Emergency Evacuation Route	-	476
Emergency Evacuation Route w/Left Arrow...	-	476
Emergency Evacuation Route w/Right Arrow...	-	476
Emergency Exit	-	476
Emergency Exit	-	496
Emergency Exit (Floor Sign)	-	421
Emergency Exit (Braille)	-	447
Emergency Exit Do Not Block	-	487
Emergency Exit Only	-	476
Emergency Exit Only (Red On White)...	-	476
Emergency Exit Only Keep Area Clear At All...	-	476
Emergency Exit Only Security Alarm Will So...	-	487
Emergency Exit Only: Alarm Will Sound	-	476
Emergency Exit: Keep Area Clear	-	476

Sign Legend Index

BradyID.com/s36

Legend Text	Header	Pg
Emergency Eye Wash	Notice	493
Emergency Eye Wash And Shower	Notice	493
Emergency Eye Wash Picto	-	485
Emergency Eye Wash Station	Notice	493
Emergency Fire Exit	-	487
Emergency Fuel Shutoff	-	458
Emergency Gas Shut-Off Do Not Block	-	458
Emergency Gasoline Shut Off	-	487
Emergency Only Pull Handle Down	-	487
Emergency Phone Numbers Fire Dept Police...	-	476
Emergency Phone Picto	-	485
Emergency Response Kit	Notice	493
Emergency Room Parking Only	-	561
Emergency Shelter	-	476
Emergency Shelter (Red On White)	-	476
Emergency Shelter For Hazardous Weather...	-	479
Emergency Shower	Safety First	493
Emergency Shower	-	494
Emergency Shower And Eye Wash	-	494
Emergency Shower And Eye Wash /...	-	442
Emergency Shower Eye Bath	Safety First	537
Emergency Shut Off	-	487
Emergency Shut-Off	Notice	474
Emergency Shutoff	-	499
Emergency Spill Response Equipment	-	458
Emergency Stairs	-	496
Emergency Stairs (Floor Sign)	-	497
Emergency Stop	-	476
Emergency Stop Button	-	516
Emergency Stop Pull Cable	-	516
Emergency Telephone	-	476
Emergency Telephone Information	-	494
Emergency Use Only	-	487
Emergency Vehicles Only	-	574
Emergency Vehicles Only Beyond This Point	-	574
Employee Parking	-	561
Employees Are Not Permitted To Remove Guard...	Safety First	515
Employees Must Not Operate Machines Without...	Safety First	515
Employees Must Wash Hands Before Leaving...	-	528
Employees Must Wash Hands Before Returning...	-	443
Employees Must Wash Hands Before Returning...	-	528
Employees Only	Caution	412
Employees Only	Danger	414
Employees Only	Notice	415
Employees Only	Parking	560
Employees Only	-	471
Employees Only	-	556
Employees Only / Solo Empleados	Notice / Aviso	441
Empty	-	458
Empty Acetylene Cylinders Do Not Use	-	458
Empty Co2 Cylinders Do Not Use	-	458
Empty Cylinders	-	458
Empty Cylinders Do Not Use	-	458
Empty Drums Only	Notice	456
Empty Nitrogen Cylinders Do Not Use	-	458
Empty Oxygen Cylinders Do Not Use	-	458
Empty Propane Cylinders Do Not Use	-	458
Emt Parking Only	-	561
End Utility Work	-	569
Energy Source	Caution	504
Engineering Dept.	-	471
Enter	-	574
Enter Here	-	574
Enter Only	-	574
Entrance	-	476
Entrance	-	566
Entrance (Braille w/Picto)	-	447
Entrance For Employees Only	Notice	415
Entrance For Employees Only	Restricted Area	555
Entrance Only	-	476
Entry Prohibited Without Permit Test For...	Caution	412
Environmental, Health & Safety Dept.	-	471
Equipment Being Serviced Do Not Operate	Danger	504
Equipment Being Serviced Do Not Operate...	Danger	437
Equipment Being Serviced Do Not Operate...	Danger	504
Equipment Being Serviced. Do Not Operate...	Danger	426
Equipment Is Not To Be Removed From This...	-	516
Equipment Locked Out Do Not Remove Locks	Danger	505
Equipment Operated By Remote Control	Caution	506
Escape Ladder	-	477
Espacio Cerrado, Entrada Solo Con Autoriza...	Peligro	437
Este Equipo Se Enciende Automaticamente	Peligro	437

Legend Text	Header	Pg
Ethyl Acetate	-	462
Ethyl Alcohol (Ethanol)	-	462
Ethylene Glycol	-	462
Ethylene Oxide Cancer Hazard And Reproduct...	Danger	452
Ev	-	565
Evacuate This Area Immediately If Fire...	Warning	486
Evacuation Assembly Area	-	487
Evacuation Assembly Point	-	484
Evacuation Route	-	477
Evacuation Slide Picto	-	485
Evaluation Letter '0' Picto	-	485
Evaluation Letter '1' Picto	-	485
Evaluation Letter '2' Picto	-	485
Evaluation Letter '3' Picto	-	485
Evaluation Letter '4' Picto	-	485
Evaluation Letter '5' Picto	-	485
Every Injury However Slight Must Be Report...	Notice	493
Every Machine In This Department Is Danger...	Be Careful	506
Every Person Has The Responsibility And...	-	547
Everyone Grinding Must Wear Goggles	Safety First	515
Except For Electric Vehicle Charging	-	565
Excessive Noise Ear Protection Must Be...	Danger	534
Excessive Radio Frequency Fields Authorize...	Warning	542
Exclusion Area Radiation Exposure Permit...	Caution	541
Exit	-	477
Exit	-	481
Exit	-	483
Exit	-	496
Exit	-	499
Exit	-	574
Exit	-	477
Exit (Braille)	-	447
Exit (Framed Sign Extra Bracket)	-	483
Exit (Framed Sign)	-	483
Exit / Salida	-	444
Exit Arrow (Floor Sign)	-	497
Exit Only	-	477
Exit Only	-	574
Exit Only Do Not Enter	-	574
Exit Only No Reentry To Building	-	487
Exit Route Do Not Block	-	487
Exit Sign	-	574
Explosion	-	458
Explosion Relief Vent Stay Clear	Danger	452
Explosive 1.[#]#[#]	-	463
Explosive Gas No Smoking	Danger	452
Explosive Gas No Smoking Or Open Flames...	Danger	452
Explosive Gases	-	459
Explosive Materials Authorized Personnel...	Danger	414
Explosive Personality Keep Out	Danger	498
Explosive Vapor No Smoking No Open Flames...	Danger	452
Explosives	Danger	452
Explosives (w/ Ghs Picto)	Danger	452
Explosives 1.1L	-	463
Explosives 1.2L	-	463
Explosives 1.3L	-	463
Explosives 1.4S	-	463
Explosives Keep Away	Danger	452
Explosives Keep Out	Danger	414
Explosives Keep Out	Warning	457
Explosives Keep Out / Explosivos No Acerca...	Danger / Peligro	438
Explosives. Follow Appropriate Precautions...	Danger	426
Extinguidor De Incendios	-	442
Extinguidor De Incendios	-	443
Extinguisher Do Not Block / Extinguidor No...	-	442
Extinguisher Missing Ext. #	-	487
Extremely Cold Liquid Nitrogen Do Not Touch	Caution	449
Eye And Ear Protection Must Be Work In Thi...	-	539
Eye And Ear Protection Must Be Worn Beyond...	Caution	530
Eye And Ear Protection Must Be Worn In...	Caution	530
Eye And Ear Protection Required In This...	Warning	538
Eye And Ear Protection Required While...	Danger	511
Eye And Glove Protection Must Be Worn When...	Caution	421
Eye And Glove Protection Must Be Worn When...	Caution	449
Eye Protection And Hard Hats Must Be Worn...	Caution	530
Eye Protection Area	Caution	530
Eye Protection Area	Danger	534
Eye Protection Area	-	496
Eye Protection Area (Floor Sign)	-	497
Eye Protection Glasses Picto	-	532
Eye Protection Glasses Picto	-	539
Eye Protection Must Be Worn	-	539

Sign Legend Index

BradyID.com/s36

Legend Text	Header	Pg
Eye Protection Must Be Worn In This Area	Safety First	537
Eye Protection Must Be Worn In This Area...	-	539
Eye Protection Must Be Worn When Grinding...	Notice	536
Eye Protection Must Be Worn When Operating...	Notice	514
Eye Protection Must Be Worn When Working...	Danger	534
Eye Protection Required	Caution	421
Eye Protection Required	Caution	530
Eye Protection Required	Notice	536
Eye Protection Required / Se Requiere Prot...	Danger / Peligro	439
Eye Protection Required / Uso Obligatorio...	Caution / Precaucion	435
Eye Protection Required Beyond This Point	Danger	534
Eye Protection Required In This Area	Safety First	537
Eye Protection Required In This Area	Warning	538
Eye Protection Required In This Area / Es...	Danger / Peligro	437
Eye Protection Required In This Area. Mode...	Caution	421
Eye protection required in this area. Moderate injury...	Caution	559
Eye Protection Required In This Area. Seri...	Danger	426
Eye Protection Required In This Area...	Caution	421
Eye Protection Required In This Area...	Caution	530
Eye Protection Required In This Area...	Danger	426
Eye Protection Required Safety Glasses	Caution	530
Eye Protection Required Safety Glasses	-	539
Eye Protection Shall Be Worn In This Area	-	539
Eye Protection Shall Be Worn When Operatin...	-	539
Eye Wash	-	494
Eye Wash	-	496
Eye Wash	-	499
Eye Wash (Floor Sign)	-	497
Eye Wash Fountain	Safety First	493
Eye Wash Fountain	-	494
Eye Wash Picto	-	494
Eye Wash Station	Emergency	431
Eye Wash Station	-	494
Eye Wash Station & Safety Shower...	Emergency	431
Eye Wash Station Keep Area Clear...	Emergency	432
Eye Wash/Lavado De Ojos	-	499

F

Face Mask Picto	-	532
Face Mask Required	Caution	530
Face Shield Area	Caution	530
Face Shield Must Be Worn When Operating...	Danger	426
Face Shield Must Be Worn When Operating...	Danger	511
Face Shield Picto	-	539
Face Shield Required In This Area	Danger	534
Face Shield Required In This Area	Notice	536
Face Shields Or Goggles Must Be Worn In...	Caution	530
Faculty And Staff Parking	-	561
Fall Hazard	Caution	506
Fall Hazard Do Not Start Work Unless Guard...	-	539
Fall Hazard. Injury May Result.	Caution	421
Fall Protection Required	Caution	530
Fall Protection Required In This Area	Caution	530
Fall Protection Required In This Area	Danger	534
Fall Protection Required In This Area	Warning	538
Falling Material	Danger	426
Falling Material	Danger	511
Falling Material.	Danger	426
Family Practice	-	502
Fasten Seat Belts Picto	-	485
Federal Regulations Require No Food To Be...	Notice	518
Fedex Pick Up	-	571
Fiber Optic Cable Above	-	558
Film Badge Required In This Area	Caution	541
Fire Alarm	-	487
Fire Alarm	-	488
Fire Alarm	-	496
Fire Alarm	-	499
Fire Alarm	-	500
Fire Alarm (Floor Sign)	-	497
Fire Alarm Call Fire Dept.	-	487
Fire Alarm Inside	-	488
Fire Alarm Panel	-	488
Fire And Explosion Hazard No Smoking Or...	Danger	522
Fire Assembly Point	-	484
Fire Blanket	-	488
Fire Blanket	-	495
Fire Damper	-	488
Fire Department Connections	-	488
Fire Department Sprinkler Connection	-	488
Fire Dept Use Only	-	488
Fire Door Alarm Will Sound If Door Is Open...	-	488

Legend Text	Header	Pg
Fire Door Do Not Block	Caution	470
Fire Door Do Not Block	-	471
Fire Door Do Not Block	-	488
Fire Door Do Not Block / Puerta De Emergen...	-	444
Fire Door Emergency Only Violators Subject...	-	471
Fire Door Keep Closed	Caution	470
Fire Door Keep Closed	-	471
Fire Door Keep Closed	-	488
Fire Door Keep Closed Do Not Block	-	488
Fire Equipment	-	488
Fire Equipment	-	499
Fire Equipment Do Not Block	-	488
Fire Equipment Keep Clear	-	488
Fire Escape	-	488
Fire Exit	-	488
Fire Exit	-	489
Fire Exit (Glow)	-	488
Fire Exit (Glow)	-	489
Fire Exit Door Must Be Kept Unlocked Durin...	-	488
Fire Exit Keep Clear	-	488
Fire Exit Please Keep Door Closed	-	488
Fire Exit Please Keep Door Closed / Salida...	-	444
Fire Extinguisher	-	433
Fire Extinguisher	-	489
Fire Extinguisher	-	490
Fire Extinguisher	-	496
Fire Extinguisher	-	499
Fire Extinguisher	-	500
Fire Extinguisher (Floor Sign)	-	497
Fire Extinguisher (6 Pack)	-	489
Fire Extinguisher (Braille w/Picto)	-	447
Fire Extinguisher (Glow)	-	489
Fire Extinguisher (w/Changeable Arrow)	-	490
Fire Extinguisher / Extinguidor De Incendi...	-	442
Fire Extinguisher / Extinguidor De Incendi...	-	443
Fire Extinguisher & Fire Picto	-	489
Fire Extinguisher Area In Front Must Be...	-	489
Fire Extinguisher Do Not Block	-	489
Fire Extinguisher Do Not Block / Extinguid...	-	443
Fire Extinguisher For All Purpose	-	489
Fire Extinguisher Halon	-	489
Fire Extinguisher Here	-	489
Fire Extinguisher Here (Glow)	-	489
Fire Extinguisher In Case Of Fire Break...	-	489
Fire Extinguisher Inside	-	489
Fire Extinguisher Inside Building	-	489
Fire Extinguisher Keep Clear At All Times...	-	489
Fire Extinguisher Picto	-	489
Fire Extinguisher Remove Pin And Squeeze...	-	433
Fire Extinguisher Use For All Fires A B C...	-	489
Fire Extinguisher Use On All Fires A B C...	-	490
Fire Extinguisher/Extinto De Incendios...	-	499
Fire Fighting Equipment Stored Inside...	-	490
Fire Hose	-	490
Fire Hose	-	491
Fire Hose	-	496
Fire Hose	-	500
Fire Hose (Floor Sign)	-	497
Fire Hose And Extinguisher Inside	-	490
Fire Hose And Fire Picto	-	490
Fire Hose Picto	-	490
Fire Hydrant Symbol	-	574
Fire Lane Keep Clear	Caution	486
Fire Lane Keep Clear At All Times	No Parking	486
Fire Lane Keep Clear At All Times	Notice	486
Fire Lane No Parking Tow-Away Zone	-	561
Fire Regulations Demand That This Space Be...	Caution	486
Fire Regulations Demand That This Space Is...	Notice	486
Fire Regulations Demand This Space Be Kept...	-	491
Fire Sprinkler Shut-Off Valve	-	491
Fire-Police-Medical Emergency Dial 911	-	491
First Aid	-	433
First Aid	-	495
First Aid	-	496
First Aid	-	500
First Aid (Floor Sign)	-	497
First Aid Equipment	-	495
First Aid Kit	Safety First	493
First Aid Kit	-	495
First Aid Kit Inside	-	495
First Aid Location	Safety First	493
First Aid Room	-	495

Sign Legend Index

BradyID.com/s36

Legend Text	Header	Pg
First Aid Station	Emergency	432
First Aid Station	Safety First	493
First Aid Station / Estacion De Primeros...	-	442
First Aid Station In Office	Safety First	493
First Aid Station In Personnel Room	Safety First	493
First Aid/Medical Locker Picto	-	485
Fishing And Hunting Stories In Progress...	Caution	498
Flagger Ahead	-	569
Flammable	Danger	452
Flammable 3	-	464
Flammable Area	Warning	486
Flammable Gas	Danger	452
Flammable Gas (w/ Ghs Picto)	Danger	452
Flammable Gas / Gas Inflammable	Danger / Peligro	438
Flammable Gas 2	-	464
Flammable Gas Keep Fire Or Flame Away No...	Danger	452
Flammable Gas Keep Fire Or Flame Away No...	Danger / Peligro	438
Flammable Gas.	Danger	427
Flammable Gas. Keep Fire Or Flame Away. No...	Danger	427
Flammable Keep Fire Away	Danger	486
Flammable Keep Flames And Heat Away	Danger	452
Flammable Liquid	Warning	486
Flammable Liquids	Caution	449
Flammable Liquids	Danger	452
Flammable Liquids No Smoking	Restricted Area	523
Flammable Liquids No Smoking, Matches Or...	Danger	452
Flammable Liquids.	Danger	427
Flammable Material Keep Fire Away...	Danger	427
Flammable Material No Smoking	Danger	453
Flammable Material No Smoking Within 20 Feet	Danger	453
Flammable Material. No Smoking Within 20 Feet...	Danger	427
Flammable Material. No Smoking. Death Or...	Danger	427
Flammable Materials	Danger	427
Flammable Materials	Danger	453
Flammable Materials (w/ Ghs Picto)	Danger	452
Flammable Materials / Materiales Inflammabl...	Danger / Peligro	438
Flammable Materials.	Danger	427
Flammable Materials.	Danger	429
Flammable No Matches Or Open Lights	Danger	453
Flammable No Smoking	-	524
Flammable No Smoking Or Open Flame Within...	-	459
Flammable No Smoking Or Open Flame Within...	-	524
Flammable Picto	-	458
Flammable Picto 3	-	464
Flammable Picto 4	-	464
Flammable Solid 4	-	464
Flammable. Keep Flames And Heat Away...	Danger	427
Flammable. No Smoking Or Open Flames...	Danger	427
Floor Load Limit No To Exceed ___ Lbs. Sq.	Caution / Precaucion	434
Floor Load Limit Not To Exceed ___ Lbs Sq.	Caution	518
Floor Opening Do Not Remove	Caution	530
Floor Slippery When Wet	Caution	421
Floor Slippery When Wet	Danger	534
Floorboards Out	Danger	469
Fluorescent Tubes	-	544
Flush Toilet After Using	Please	519
Flying Debris Hazard Keep Door Closed While...	Danger	453
Foam Inlet	-	491
Follow Confined Space Entry Procedure Before...	Danger	468
Follow Fall Protection Guidelines When Working...	Notice	536
Follow Lockout/Tagout Procedures...	Danger	427
Food Prep Area	-	516
Food Preparation Area Cooked Food Only	-	516
Food Preparation Area Raw Food Only	-	516
Foot Protection Required	Caution	530
Foot Protection Required In This Area	Safety First	537
Foot Protection Required In This Area...	Caution	530
For Chemical Storage Only No Food Permitted	Notice	456
For Fire Use Only	-	491
For Security Reasons Individuals Entering...	Notice	555
For Use On All Fires	-	491
For Your Own Safety Talk Safety	Safety First	553
Fork Lift Trucks Go Slow	Caution	506
Fork Lift Trucks Operating Beyond This...	Caution	557
Forklift Traffic Keep Clear	Caution	421
Forklift Traffic Keep Clear / Trafico De...	Caution / Precaucion	435
Forklift Traffic Stay Clear	Danger	571
Formaldehyde Irritant And Potential Cancer...	Danger	453
Formic Acid	-	462
Formwork Stripping Area Falling Material...	Danger / Peligro	439
Fr Clothing Required	Caution	531
Fragile Equipment Do Not Touch	Caution	506
Freezing Temperature When Blue	-	516

Legend Text	Header	Pg
Front End Parking Only	-	561
Fuel	Danger	453
Fuel Oil	Danger	453
Fuel Oil	-	462
Fuel Oil 3	-	464
Fuel Storage No Smoking	Danger	522
Full	-	459
Full Acetylene Cylinders Ready For Use	-	459
Full Co2 Cylinders Ready For Use	-	459
Full Cylinders	-	459
Full Cylinders Ready For Use	-	459
Full Face Respirator Must Be Worn In This...	Caution	530
Full Nitrogen Cylinders Ready For Use	-	459
Full Oxygen Cylinders Ready For Use	-	459
Full Propane Cylinders Ready For Use	-	459
Fumes May Be Present	Caution	449
Fumes May Be Present	Warning	457

G

Gas	Danger	453
Gas Cylinder Storage Area	Danger	453
Gas Mask Picto	-	532
Gas No Smoking, Matches Or Lights	-	459
Gas Only	-	459
Gasoline	Warning	457
Gasoline	-	462
Gasoline And Oil	Danger	453
Gasoline No Smoking	Danger	453
Gates Open And Close Automatically	Danger	414
Gates Open And Close Automatically	-	417
Genetics	-	502
Girls	-	545
Glass Only	-	544
Gloves Picto	-	532
Gloves Required	Caution	530
Gloves Required / Uso Obligatorio De Guantes	Caution / Precaucion (ANSI)	435
Gloves Required In This Area	Caution	530
Go Slow Sound Signal	Danger	571
Goggles Must Be Worn When Working In This...	Caution	530
Goggles Positively Must Be Worn	Caution	530
Good Housekeeping Is The First Principle...	-	520
Good Housekeeping Promotes Safety	-	548
Good Housekeeping Promotes Safety Do Your...	-	520
Good Housekeeping This Is Your Home Away...	-	520
Ground All Barrels	Caution	472
Guard Dogs On Duty	Danger	414

H

H2S May Be Present	Danger	453
H2S May Be Present. No Open Flames. Wear...	Danger	427
H2S Poisonous Gas	Danger	453
H2S Poisonous Gas May Be Present	Caution	449
H2S Poisonous Gas May Be Present. No Open...	Caution	421
H2S Poisonous Gas May Be Present. No Open...	Danger	427
H2S Poisonous Gas. No Open Flames. Wear...	Caution	421
H2S Poisonous Gas. No Open Flames. Wear...	Danger	427
Hair And Beard Nets Required	-	539
Hair Covering Required In This Area	Notice	536
Hair covering required in this area.	Notice	559
Hair Net Required Beyond This Point	Notice	536
Hairnets and beard covers required in this area.	Notice	559
Hairnets And Beard Covers Required In This...	Notice	536
Halon	-	491
Halon Extinguisher For Use On Computer...	-	491
Hand Hazard Turn Power Off Before Reaching...	Danger	511
Hand Hazard Watch Your Fingers	Danger	511
Hand Signals For Shovel-Crane Operation...	-	516
Hand Wash Only	-	520
Handcapped Parking Van Accessible...	-	566
Handicapped	-	566
Handicapped Parking	-	566
Handicapped Parking Only	-	566
Handicapped Parking Permit Required...	-	566
Handicapped Parking Sign	-	566
Handicapped Parking State Permit Required	-	567
Handicapped Parking Towing Enforced...	-	567
Handicapped Picto	-	496
Handicapped Picto	-	566
Handicapped Picto (Braille)	-	447
Handicapped Ramp Picto	-	566
Hard Hat Area	Caution	558
Hard Hat Area	Danger	427

Sign Legend Index

BradyID.com/s36

Legend Text	Header	Pg
Hard Hat Area	Danger	511
Hard Hat Area	Warning	538
Hard Hat Area	-	496
Hard Hat Area	-	539
Hard Hat Area (Floor Sign)	-	497
Hard Hat Area / Usar Casco Protector En Es...	Danger / Peligro	439
Hard Hat Area	Danger	427
Hard Hat Picto	-	532
Hard Hat Picto	-	539
Hard Hat Protection Required	Danger	534
Hard Hat Required Beyond This Point	Caution	558
Hard Hat Required Beyond This Point	Danger	534
Hard Hat Required In This Area	Danger	427
Hard Hat, Safety Glasses And Hearing Protection...	-	547
Hard Hats - Safety Glasses - Safety Shoes...	Caution	529
Hard Hats And Eye Protection Required In...	Notice	536
Hard Hats And Fall Protection Must Be Worn...	Notice	536
Hard Hats And Safety Glasses With Clear...	-	547
Hard Hats Ear And Eye Protection Required...	Danger	535
Hard Hats Ear And Eye Required Protection...	Danger	535
Hard Hats Must Be Worn At All Times	-	547
Hard Hats Must Be Worn In This Area	Notice	536
Hard Hats Must Be Worn In This Area	-	547
Hard Hats Must Be Worn In This Area / Se D...	Notice / Aviso	441
Hard Hats Must Be Worn On Site	Danger	535
Hard Hats Must Be Worn On This Contruction...	Notice	536
Hard Hats Required	Caution	421
Hard Hats Required	Caution	531
Hard Hats Required / Uso Obligatorio De Ca...	Caution / Precaucion	435
Hard Hats Required In This Area	Caution	531
Hard Hats Required In This Area	Notice	536
Hard Hats Required In This Area. / Es Obli...	Danger / Peligro	437
Hard Hats Required On This Job By All Empl...	-	539
Hard Hats Required When This Equipment Is...	-	539
Hard Hats, Safety Glasses, Safety Shoes...	Caution	531
Hard Head Area	Danger	498
Haute Tension	Danger	473
Have You Hugged Your Maintenance Manager...	Notice	498
Have You Hugged Your Safety Manager Today?	Notice	498
Hazard	-	543
Hazard Area No Unauthorized Personnel...	Danger	414
Hazard Area. No Unauthorized Personnel...	Danger	427
Hazardous Area	Danger	453
Hazardous Area Authorized Personnel Only	Caution	412
Hazardous Area No Smoking	-	524
Hazardous Area	Danger	427
Hazardous Chemicals	Danger	453
Hazardous Chemicals / Sustancias Quimicas...	Danger / Peligro	439
Hazardous Chemicals Authorized Personnel...	Caution	449
Hazardous Chemicals. Improper Contact Will...	Danger	427
Hazardous Material Area Authorized Personnel...	Danger	453
Hazardous Material Area. Authorized Person...	Danger	427
Hazardous Material Check Msds	Danger	453
Hazardous Material Storage Area	Warning	457
Hazardous Material Storage Area.	Warning	433
Hazardous Materials	Danger	453
Hazardous Materials 9	-	464
Hazardous Materials Handle With Care	Caution	449
Hazardous Materials May Be Used In This...	Caution	449
Hazardous Materials. Improper Contact Will...	Danger	427
Hazardous Waste	Danger	453
Hazardous Waste	Warning	457
Hazardous Waste Area Labeled Drums Only	Caution	449
Hazardous Waste Material Storage Only No...	Caution	449
Hazardous Waste Material Storage Only No...	Caution / Precaucion	434
Hazardous Waste Material Storage Only. No...	Caution	421
Hazardous Waste Oil	Danger	453
Hazardous Waste Storage	Danger	453
Hazardous Waste Storage	-	459
Hazardous Waste Storage Area Unauthorized...	Caution	449
Hazardous Waste Storage Area Unauthorized...	Danger	453
Hazardous Waste Storage Area Unauthorized...	Danger / Peligro	436
Hazardous Waste Storage Area. Unauthorized...	Caution	421
Hazardous Waste Storage Area. Unauthorized...	Danger	427
Hazardous Waste Treatment Area Unauthorized...	Danger	453
Hazardous Waste.	Danger	427
Head In Parking Only	-	561
Head In To Park	-	561
Head Protection Must Be Worn	-	539
Health Education	-	502
Health Hints Clean Toilet Rooms Mean Good...	-	520
Health Services	-	502
Hearing Protection And Safety Glasses Must...	Notice	536

Legend Text	Header	Pg
Hearing Protection And Safety Glasses Must...	Notice / Aviso	440
Hearing Protection And Safety Glasses Must...	-	547
Hearing Protection Must Be Worn At All Tim...	-	547
Hearing Protection Must Be Worn In This...	Caution	531
Hearing Protection Must Be Worn In This...	Notice	536
Hearing Protection Must Be Worn In This...	Notice / Aviso	440
Hearing Protection Must Be Worn In This...	-	547
Hearing Protection Required	Caution	531
Hearing Protection Required / Uso Obligato...	Caution / Precaucion	435
Hearing Protection Required After ____ Hr...	Caution	531
Hearing Protection Required Beyond This...	Caution	558
Hearing Protection Required Beyond This...	Danger	535
Hearing Protection Required For Prolonged...	Caution	531
Hearing Protection Required Here	Caution	531
Hearing Protection Required Here	-	539
Hearing Protection Required In This Area	Danger	535
Hearing Protection Required In This Area	Warning	538
Hearing Protection Required In This Area...	Caution	421
Hearing Protection Required In This Area...	Caution	422
Hearing Protection Required While Equipment...	Caution	531
Hearing Protection Required. / Uso Obligat...	Danger / Peligro	439
Heart Pacemaker Implants This Room Contain...	Caution	541
Helium Empty Cylinders	-	459
Helium Full Cylinders	-	459
Helium Neon Laser Do Not Stare Into Beam	Caution	541
Help Keep Our Facility Clean	-	547
Help Keep This Fountain Clean And Sanitary...	Notice	518
Help Keep This Place Clean	-	520
Help Keep This Place Clean / Ayude A Mante...	-	442
Help Keep This Plant Clean Put Rubbish And...	Notice	518
Help Keep This Plant Safe And Clean	Notice	519
Heptane	-	462
Hexane	-	462
Hexavalent Chromium Chromium...	Danger	453
High Explosives	Danger	453
High Impact Safety Glasses Area	Danger	535
High Impact Safety Glasses Beyond This...	Notice	536
High Impact Safety Glasses Required	Caution	531
High Intensity Ultraviolet Light Wear Eye...	Caution	531
High Noise Area Hearing Protection May...	Caution	531
High Noise Area Wear Ear Plugs	Notice	536
High Noise Area Wear Ear Protection	Warning	538
High Noise Area Wear Ear Protection...	Danger	427
High Noise Area Wear Hearing Protection	Caution	531
High Noise Level Area	Caution	531
High Noise Level Use Ear Protection	Caution	531
High Pressure	Danger	453
High Pressure Air Authorized Personnel...	Warning	457
High Pressure Gas Line	Danger	453
High Pressure Gas Line.	Danger	427
High Pressure Pipeline	Caution	449
High Pressure.	Danger	427
High Radiation Area	-	543
High Speed Saw	Danger	511
High Voltage	Danger	428
High Voltage	Danger	473
High Voltage	Danger	558
High Voltage	Warning	474
High Voltage	-	474
High Voltage ____ Volts	Danger	474
High Voltage / Alto Voltaje	Danger / Peligro	436
High Voltage Above	Danger	473
High Voltage Above. Contact Will Cause...	Danger	428
High Voltage Authorized Personnel Only	Danger	473
High Voltage Authorized Personnel Only...	Danger	428
High Voltage Contact Could Result In Serious...	Warning	433
High Voltage Do Not Remove This Barrier	Danger	473
High Voltage Electrical Equipment...	Danger	473
High Voltage Inside	Danger	473
High Voltage Keep Away	Danger	473
High Voltage Keep Away	Warning	474
High Voltage Keep Off	Danger	473
High Voltage Keep Out	Danger	414
High Voltage Keep Out	Danger	428
High Voltage Keep Out	Danger	558
High Voltage Keep Out	-	474
High Voltage Keep Out / Alto Voltaje No...	Danger / Peligro	436
High Voltage Keep Out Will Result In Serious...	Danger	428
High Voltage On Wires Above	Danger	473
High Voltage Overhead	Danger	473
High Voltage Picto	-	474
High Voltage Testing In Progress	Danger	473
High Voltage Turn Power Off And Lock Out...	Danger	505

Sign Legend Index

BradyID.com/s36

Legend Text	Header	Pg
High Voltage Turn Power Off Before Servicing	Danger	428
High Voltage Turn Power Off Before Servicing...	Danger	428
High Voltage Unauthorized Personnel Keep...	Danger	414
High Voltage Underground Cable	Danger	474
High Voltage Will Result In Serious Shock...	Danger	428
High Voltage Will Result In Shock Or Death	Danger	428
High Voltage Within	Danger	474
High Voltage Within Keep Out	Danger	474
High Voltage Within Keep Out Contact Will...	Danger	428
High Voltage: Do Not Enter This Enclosure	Caution	472
High Voltage: Contact Could Result In Serious...	Danger	427
High Voltage: Keep Away: Contact Will Result...	Danger	428
High voltage: Will result in shock or death.	Danger	559
Highly Combustible Area No Welding, Burning...	Danger	453
Highly Flammable	Danger	453
Highly Toxic Handle With Care	Danger	453
Hole Cover Do Not Remove / Cubierta De Hoyo...	Danger / Peligro	437
Hospital Visitor Parking Only	-	561
Hot	Caution	507
Hot	Danger	428
Hot	Danger	511
Hot	Warning	515
Hot	-	517
Hot / Caliente	Danger / Peligro	437
Hot Acid	Danger	454
Hot Do Not Touch	Danger	511
Hot Do Not Touch: Will Cause Severe Burns...	Danger	428
Hot Equipment Unauthorized Persons Keep...	Danger	511
Hot Keep Away	Caution	507
Hot Lead Use Protective Equipment	Danger	454
Hot Metal	Danger	469
Hot Pipes	Danger	454
Hot Pipes Do Not Touch	Danger	469
Hot Surface	-	517
Hot Surface Do Not Touch	Caution	422
Hot Surface Do Not Touch	Danger	428
Hot Surface Do Not Touch	Danger	511
Hot Surface Do Not Touch / Superficie Cali...	Caution / Precaucion	435
Hot Surface: Do Not Touch.	Caution	422
Hot surface: Do not touch.	Caution	559
Hot Surface: Do Not Touch.	Danger	428
Hot Work Area	Caution	507
Hot Work Area.	Caution	422
Hot Work Fire Watch Area	Danger	469
Hot Work Permits Are Required For All Weld...	Notice	514
Hot: Contact Can Result In Severe Burn...	Warning	433
Hot: Contact May Result In Injury.	Caution	422
Hot: Do Not Touch: Will Cause Severe Burns...	Danger	428
Hot: Keep Away Injury May Result.	Caution	422
Hot: Keep Away: Injury May Result.	Caution	422
Hot: Keep Away: Injury May Result.	Caution	428
Hot: Surface Do Not Touch.	Caution	422
Hot: Will Cause Severe Burns Or Injury.	Danger	428
Household & Garden Chemicals	-	544
How To Lift Correctly...	-	495
Hunting Or Fishing On These Grounds...	-	418
Hydrochloric Acid	Danger	454
Hydrochloric Acid	-	462
Hydrochloric Acid (Hcl)	Danger	454
Hydrochloric Acid: Improper Contact Will...	Danger	428
Hydrofluoric Acid	-	462
Hydrofluorsilicic Acid	-	462
Hydrogen	Danger	454
Hydrogen Flammable Gas No Smoking Or Open...	Danger	454
Hydrogen Peroxide	Danger	454
Hydrogen Peroxide, 52%	-	462
Hydrogen Sulfide (H2S)	Danger	454
Hydrogen: Flammable Gas. No Smoking Or Open...	Danger	428

I

I'M So Far Behind I Might Run Over Myself	Notice	498
Icy Conditions When Blue	-	517
Icy Surface	Caution	507
If Fire Alarm Sounds Call Fire Dept.	-	491
If Machine Is Not Operating Properly Advise...	Danger	511
If We Are To Have Efficiency In Our Organization...	Notice	518
If You Drop It Pick It Up If You Spill It...	-	520
If You Get Chemicals On Your Body Or Eyes...	Safety First	456
If You Think Osha Is A Small Town In Wisco...	Caution	498
If You Use It Clean It	-	520
Illegally Parked Cars Will Be Towed Away A...	-	561
Illegally Parked Vehicles Will Be Towed At...	-	561
Imaging	-	502

Legend Text	Header	Pg
Immersion Suit Picto	-	485
Immunizations	-	502
Impaired Headroom	Caution	507
Improper Disposal Of Chemicals Is Punishable...	Notice	456
Improper Disposal Of Chemicals Is Punishable...	Warning	457
In	-	471
In Accordance With Osha Standard...	Notice	505
In Case Of Emergency Break Glass	-	491
In Case Of Emergency Dial 9 Then 911	-	491
In Case Of Emergency Dial 911	-	495
In Case Of Emergency Report To Evacuation...	-	491
In Case Of Fire Assembly Point Is.....	-	491
In Case Of Fire Do Not Use Elevator Use...	-	444
In Case Of Fire Do Not Use Elevators Use...	-	491
In Case Of Fire Pull Firmly Here...	-	491
In Case Of Fire Unreel Hose Completely The...	-	491
Infection Hazard Handle Needles With Care	Danger	445
Infectious Diseases	-	502
Infectious Waste Area	Danger	445
Infectious Waste Area Use Precautions	Danger	445
Infectious Waste Notify Public Health Auth...	-	445
Inflamable	Peligro	438
Inhalation Hazard 2	-	464
Inhalation Hazard 6	-	464
Inhalation Hazard Do Not Breathe Vapors...	Danger	454
Inorganic Arsenic Cancer Hazard Authorized...	Danger	454
Inpatient	-	502
Inspect Slings Before Use	Caution	507
Intensive Care	-	503
Internal Medecine	-	503
Internal Medicine	-	503
Interpretive Services	-	503
Is Our Responsibility Each And Every One...	Safety First	553
Isopropanol	-	462
Isopropyl Acetate	-	462
It Is Illegal & Against Company Policy To...	Warning	457
It Is Unlawful And Dangerous To Dispense...	Warning	457

J		
Just Do It Safely	-	548

K		
Keep Aisles Clear	Caution	570
Keep Aisles Clear	-	496
Keep Aisles Clear (Floor Sign)	-	497
Keep Aisles Clear If It's Not Moving It Do...	Caution	518
Keep All Aisles Clear	Caution	518
Keep All Cylinders Chained	Caution	449
Keep All Cylinders Chained	Danger	454
Keep All Cylinders Chained	Warning (ANSI)	433
Keep All Cylinders Chained / Mantener Los...	Warning / Advertencia (ANSI)	442
Keep All Cylinders Chained / Mantener Todo...	Caution / Precaucion	434
Keep All Cylinders Chained / Mantener Todo...	Danger / Peligro	438
Keep All Cylinders Chained.	Danger	429
Keep All Guards In Place Wear Goggles	Be Careful	529
Keep Area Clean / Mantener Limpia Esta Are...	Notice / Aviso	441
Keep Away	Caution	412
Keep Away	Danger	414
Keep Away Do Not Climb Over This Enclosure	Danger	414
Keep Away From Heat	Danger	454
Keep Clear When Boom Is Near High Voltage	Caution	507
Keep Closed	Caution	470
Keep Cylinders Chained	Notice	456
Keep Door Closed	Notice	432
Keep Door Closed At All Times	-	471
Keep Electric Panel Area Clear	Caution	422
Keep Electric Panel Area Clear	Caution	472
Keep Electrical Panel Clear For 36 Inches	Caution	422
Keep Electrical Panel Clear For 36 Inches	Caution	472
Keep Everything Away From This Fire Door...	Notice	470
Keep Fingers Clear Of Machine While In Mot...	Danger	511
Keep Floors Clear Of Oil-Grease Or Other...	Safety First	515
Keep From Under Conveyor	Danger	511
Keep Gates Closed	Danger	414
Keep Gates Closed	-	418
Keep Guards In Place	Danger	511
Keep Guards In Place / Mantener Las Guarda...	Danger / Peligro	438
Keep Hands Clear	Danger	511
Keep Hands Clear / Mantener Las Manos Alej...	Danger / Peligro	438
Keep Hands Clear Of Moving Machinery	Warning	515
Keep Hands Clear When Equipment Is Running...	-	443
Keep Hands Clear While Blades Are Turning	Danger	511

Sign Legend Index

BradyID.com/s36

Legend Text	Header	Pg
Keep Hands Off	Caution	507
Keep Hands Out Of Machinery	Warning	433
Keep Hands Out Of Moving Machinery	Safety First	515
Keep Hands Out Of Moving Machinery / Mante...	Caution / Precaucion	434
Keep Material Away From Fire Door So The...	Caution	518
Keep Off	Danger	414
Keep Off	Warning	417
Keep Off Roof	Danger	414
Keep Off Tracks	Danger	571
Keep Off.	Danger	429
Keep Our Plant Clean And Safe	-	548
Keep Out	Caution	412
Keep Out	Danger	414
Keep Out	Danger	429
Keep Out	Restricted Area	417
Keep Out	-	418
Keep Out Authorized Personnel Only	-	556
Keep Out From Under Crane Loads	Caution	507
Keep Out Fumigating With Poisonous Gas	Danger	454
Keep Out Hazard Area	Danger	414
Keep Out Hazardous Chemicals	Danger	454
Keep Out Radiation Area X-Ray Keep Out...	-	543
Keep Out Radiation Area X-Ray: Keep Out...	-	543
Keep Out: Radiation Area X-Ray Keep Out...	-	543
Keep Out.	Danger	428
Keep Passageway And Doorway Clear	Notice	475
Keep Right	-	574
Keep Storage 36" Below Sprinklers	-	492
Keep This Area Clean	Notice	518
Keep This Area Clean	Safety First	519
Keep This Area Clean Your Mother Isn't Her...	-	520
Keep This Area Clear	Notice	486
Keep This Door Closed	Caution	470
Keep This Door Closed	Notice	415
Keep This Door Closed	Notice	432
Keep This Door Closed	Notice	470
Keep This Door Closed / Mantener Esta Puer...	Notice / Aviso	441
Keep This Door Closed At All Times	Notice	514
Keep This Doorway Free Of Obstructions So...	Notice	486
Keep This Gate Closed	Danger	429
Keep This Gate Closed	Danger	511
Keep This Passageway Clear	Notice	571
Keep This Place Clean And Orderly	Please	519
Keep This Place Clean And Orderly	-	520
Keep This Place Clean And Orderly...	Notice	432
Keep This Plant Safe And Clean	Safety First	519
Keep This Space Clear At All Times	Caution	518
Keep This Space Clear At All Times	-	520
Keep Your Work Area Clean It Is Part Of...	-	520
Kerosene	-	462
Kerosene No Smoking No Open Flames	Danger	454
Kidney	-	503

L

Label All Drums	Notice	456
Laboratory	-	503
Ladies	-	545
Laser Area	Caution	541
Laser Area. Vision Damage May Result.	Caution	422
Laser Beams Do Not Look Directly At Laser...	Danger	541
Laser Beams. Do Not Look Directly At Laser...	Danger	429
Laser Beams. Do Not Look Directly At Laser...	Danger	430
Laser Operating	Warning	542
Laser Operating Protect Eyes And Skin From...	Danger	429
Laser Radiation Avoid Direct Exposure To...	Danger	541
Laser Radiation Avoid Eye Or Skin Exposure...	Danger	541
Laser Radiation Do Not Stare Into Beam Or...	Caution	531
Laser Radiation. Avoid Direct Exposure To...	Danger	429
Laser Radiation. Avoid Eye Or Skin Exposure...	Danger	429
Laser Range In Use Do Not Enter	Danger	541
Laser Repair In Progress Do Not Enter When...	Notice	542
Laser Test Area Do Not Approach This Area...	Danger	541
Laser Wear Protective Laser Goggles	Danger	541
Lavarse Las Manos Antes De Salir De Este...	Aviso	440
Lead Hazard Area Wear Respirator Possessio...	Caution	449
Lead Hazard Do Not Enter Work Area Unless...	Caution	449
Lead May Damage Fertility Or The Unborn...	Danger	454
Lead Work Area Poison No Smoking Or Eating	Warning	457
Lead Work Area Respirator Required	Danger	454
Lead Work Area. Poison. No Smoking Or Eati...	Warning	433
Left	-	569
Left Turn Signal	-	574
Let Us All Be Safety Inspectors Report Uns...	Safety First	553

Legend Text	Header	Pg
Life Jackets Must Be Worn Beyond This Poin...	Notice	536
Lifebuoy Picto	-	485
Lifebuoy With Light Picto	-	485
Lifebuoy With Line Picto	-	485
Lifeline Must Be Hooked Up While On Platfo...	Caution	466
Lifeline Required	Caution	466
Lifeline Required For Entry	Danger	468
Lift Raft Picto	-	485
Limited Access Area Authorized Personnel O...	Notice	415
Liquefied Hydrogen Flammable Gas No Smokin...	Danger	454
Liquid Nitrogen	Danger	454
Liquid Nitrogen Gloves And Face Shield Req...	Caution	531
Liquid Petroleum Gas	Danger	454
Live Steam	Danger	454
Live Steam.	Danger	429
Live Wire Overhead	Danger	474
Live Wire Overhead. Contact Will Result In...	Danger	429
Loading And Unloading Zone	-	574
Local Alarm Only Not Connected To Fire Dep...	-	492
Lock Out All Power Sources Before Entering...	Caution	504
Lock Out Before Maintenance Or Any Operato...	Caution	504
Lock Out Before Maintenance Or Any Operato...	Notice	505
Lock Out Before Servicing	Danger	505
Lock Out Before Servicing	-	433
Lock Out Before Servicing. Failure To Lock...	Danger	429
Lock Out Electrical Equipment Before Perfo...	Caution	504
Lock Out Electrical Switches Before Workin...	Danger	505
Lock Out Electrical Switches Before Workin...	Danger / Peligro	436
Lock Out Equipment Before Entering	Danger	505
Lock Out Equipment Before Entering / Bloqu...	Danger / Peligro	436
Lock Out Equipment Before Entering. Failur...	Danger	429
Lock Out Equipment Before Servicing. /...	Danger / Peligro	436
Lock Out For Safety	Caution	504
Lock Out For Safety	Danger	505
Lock Out For Safety	-	505
Lock Out For Safety Before You Start	Caution	504
Lock Out For Safety. Failure To Lock Out M...	Caution	422
Lock Out Here	-	505
Lock Out Power Before Opening Guards Acces...	Caution	504
Lock Out Switches Before Working On Equipm...	Warning	505
Lock Valves Before Entering Tanks	Caution	504
Lock-Out For Safety Before You Start / Por...	Caution / Precaucion	435
Lock-Out/Tag-Out Power Before Servicing...	Danger	505
Locker With Additional Breathing Apparatus	-	485
Lockout Center	-	500
Lockout Safety Center w/Down Arrow	-	500
Lockout Tagout Center	Safety First	432
Look Out For Cars	Danger	511
Look Out For Contact Hazards And Moving...	Caution	507
Look Out For Crane	Danger	512
Look Out For Fork Lifts	Danger	429
Look Out For Fork Lifts	Warning	515
Look Out For Fork Lifts	Danger	512
Look Out For Forklifts / Cuidado Con Los M...	Caution / Precaucion	434
Look Out For Lift Trucks	Danger	512
Look Out For Lift Trucks	Warning	571
Look Out For Lift Trucks / Cuidado Con Los...	Danger / Peligro	437
Look Out For Lift Trucks. Accident Will Ca...	Danger	429
Look Out For Powered Industrial Trucks	Caution	570
Look Out For Trucks	Danger	512
Look Up Power Lines Overhead	Caution	472
Look Up. Power Lines Overhead. Serious Inj...	Caution	422
Low Clearance	Caution	507
Low Clearance	Danger	512
Low Clearance	Warning	515
Low Clearance / Poca Altura	Danger / Peligro	439
Low Clearance Accident Will Result In Seri...	Danger	429
Low Headroom	Caution	507
Low Headroom	Danger	512
Low Headroom	Warning	515
Low Headroom	-	517
Low Headroom Injury May Result.	Caution	422
Low Overhead Clearance	Caution	422
Low Overhead Clearance	Caution	507
Low Overhead Clearance	Danger	512
Low Overhead Clearance Accident Will Resul...	Danger	429
Low Overhead Clearance Injury May Result	Caution	422
Low Pressure Manifold Do Not Connect High...	Caution	449
Low-Pressure Manifold Do Not Connect High...	-	459
Lower Lifeboat Picto	-	485
Lower Rescue Boat Picto	-	485
Lp Gas Storage No Smoking Or Open Flames...	Danger	454
Lp Gas Storage. No Smoking Or Open Flames...	Danger	429

Sign Legend Index

BradyID.com/s36

Legend Text	Header	Pg
M		
M.S.D.S.	-	500
Machine Lockout Point	Caution	504
Machine Starts Automatically Keep Hands...	Caution	507
Magnetic Field In Place	Warning	542
Main Electric Shut-Off	Caution	472
Main Gas Cut Off	Notice	514
Main Office	-	471
Main Power Cut Off	Notice	515
Main Sprinkler Valve	-	492
Maintenance Dept.	-	471
Maintenance Personnel Only	Notice	415
Maintenance Shop	-	471
Make Every Move A Safe One	Think	553
Make Quality A Company Wide Commitment...	-	548
Make Safety A Daily Habit	-	548
Make Sure All Power Sources Are Locked Out...	Caution	504
Make Time For Safety	-	548
Make Your Work Place Safe Before Starting...	Safety First	553
Mammography	-	503
Man Picto	-	545
Mandatory Action Caution Prohibition Envir...	-	547
Manguera Para Incendios	-	443
Mantener Cerrada Esta Puerta	Aviso	441
Mantener Las Manos Alejadas	Peligro	438
Mantener Los Cilindros Encadenados...	Peligro	438
Many Food and Beverage Cans Have Linings...	Warning	461
Marsec	-	557
Material Safety Data Sheets & The Written...	Notice	456
Material Safety Data Sheets Available Upon...	Notice	456
Material Safety Data Sheets Available Upon...	Notice / Aviso	440
Maximum Height _____ Ft. _____ In.	Caution	507
Maximum Load _____ Lbs.	Caution	507
May Contain Asbestos Do Not Disturb Pipe...	Danger	454
Meat Wash Only	-	517
Medical Library	-	503
Medical Records	-	503
Meet The Person Most Responsible For Your...	-	539
Men	-	501
Men	-	545
Men (Braille w/Picto)	-	447
Men / Hombres	-	443
Men Working	Danger	512
Men Working	Warning	515
Men Working	-	569
Men Working Above	Danger	512
Men Working Above	Danger	558
Men Working Above / Hombres Trabajando...	Danger / Peligro	438
Men Working Above Proceed With Caution	Danger	429
Men Working Below	Danger	512
Men Working Below	Warning	515
Men Working Below / Hombres Trabajando Aba...	Danger / Peligro	438
Men Working Do Not Start	Danger	512
Mental Health	-	503
Mercury	-	462
Methanol	-	462
Methyl Ethyl Ketone	-	462
Microwave Frequencies Present	Danger	541
Microwave Hazard In This Area	Notice	542
Microwave In Operation	Caution	541
Microwave In Use / Microondas En Uso	Caution / Precaucion	434
Microwave Oven Could Be Harmful To Persons...	Caution	541
Microwave Oven In Use	Danger	541
Microwave Oven In Use	Notice	542
Microwave Oven In Use.	Danger	429
Monitored By Video Camera	Restricted Area	555
Monitored By Video Camera / Area Monitorea...	Restricted Area / Area Restringida	442
More Than One Energy Source Locations Are...	-	505
Motorcycle Parking Only	-	561
Moving Machinery	Danger	512
Moving Machinery / Maquinaria En Movimient...	Danger / Peligro	438
Moving Machinery Do Not Enter	Danger	414
Moving Machinery Do Not Enter / Maquinaria...	Danger / Peligro	438
Moving Machinery Stay Clear. Accident Will...	Danger	429
Moving Saw Blade May Result In Loss Of Fin...	Danger	512
Mowing Ahead	-	569
MRI	-	503
MRI / PET	-	503
Msds	-	501
Msds And The Written Hazardous Communicati...	Notice	456
Msds And The Written Hazardous Communicati...	Notice / Aviso	440

Legend Text	Header	Pg
Msds Info	-	501
Msfs Info	-	501
Muriatic Acid	-	462
Muster Point	-	484
Muster Point 1	-	484
Muster Point 2	-	484
Muster Point 3	-	484
Muster Point 4	-	484
Muster Point 5	-	484
Muster Point 6	-	484
Muster Point 7	-	484
Muster Point 8	-	484
N		
N.O.R.M. Naturally Occurring Radioactive...	Caution	422
N.O.R.M. Naturally Occurring Radioactive...	Caution	541
Natural Gas	Danger	454
Natural Gas.	Danger	429
Naturally Occurring Radioactive Material	Caution	541
Neurology	-	503
Never Be Hasty	-	548
New Chemical Storage Only	Danger	454
Nip Point	Danger	512
Nitric Acid	Danger	454
Nitric Acid	-	462
Nitric Acid. Improper Contact Will Cause...	Danger	429
Nitrogen	Danger	454
Nitrogen .	Danger	429
Nitrogen Empty Cylinders	-	459
Nitrogen Full Cylinders	-	459
Nitrogen Storage No Smoking No Open Flames	Danger	454
Nitrogen, Liquid	-	462
Nitrogen.	Danger	429
No Admittance	Danger	414
No Admittance	Notice	415
No Admittance	-	418
No Admittance Apply At Office	Notice	415
No Admittance Authorized Employees Only...	-	444
No Admittance Authorized Persons Only	-	418
No Admittance Authorized Persons Only	-	556
No Admittance Beyond This Point Check With...	Security Notice	555
No Admittance Employees Only	Notice	416
No Admittance Employees Only	Restricted Area	555
No Admittance Employees Only	-	556
No Admittance Employees Only Vendors...	-	418
No Admittance Except For Assigned Employee...	-	418
No Admittance Except To Employees On Duty	Danger	414
No Admittance Except To Employees On Duty	-	556
No Admittance Please Use Other Door	-	418
No Admittance Ring Bell For Service	-	556
No Admittance Without A Permit	Notice	416
No Admittance Without Authorization	Danger	414
No Admittance Without Authorization	Restricted Area	555
No Admittance Without Authorization	-	556
No Admittance Without Pass From Office	Notice	416
No Admittance Without Security Pass	Security Notice	555
No Alcoholic Beverages Or Drugs Permitted...	Notice	555
No Beverages Or Food Allowed In This Area	-	520
No Bicycles Skateboards Rollerblades...	-	557
No Bull	-	498
No Burning Welding Or Open Flame Without...	-	492
No Cell Phones	-	501
No Cell Phones / No Texting While Driving	-	547
No Cellular Phone Or Two Way Radios Allowed	Notice	521
No Cellular Phones	-	521
No Cellular Phone Picto	Security Notice	521
No Cellular Phones	-	521
No Cellular Phones Allowed	Notice	521
No Chemical Storage Allowed In This Area	-	459
No Chemicals In Drain Use Chemical Waste...	Caution	449
No Clearance	Danger	512
No Clearance For Man On Car	Danger	512
No Corner Ni Beber En Esta Area	Aviso	441
No Concealed Weapons Allowed On Company...	-	547
No Concealed Weapons Allowed On This Prope...	-	521
No Dogs Allowed	-	418
No Double Parking	-	561
No Dumping	-	520
No Dumping Violators Will Be Prosecuted	-	557
No Dumping Violators Will Be Prosecuted	-	574
No Eating Or Drinking In This Area	Notice	518
No Eating Or Drinking In This Area / Prohi...	Notice / Aviso	441
No Eating, Drinking, Or Smoking	-	445

Sign Legend Index

BradyID.com/s36

Legend Text	Header	Pg
No Entrar	Peligro	439
No Entrar Solo Personal Autorizado	Peligro	439
No Entry	-	478
No Entry By Unauthorized Personnel	-	543
No Entry Picto	-	418
No Entry Unless Authorized	Notice	416
No Entry Unless Authorized	Restricted Area	555
No Es Salida	-	443
No Exit	Notice	432
No Exit	Notice	475
No Exit	-	478
No Exit / No Hay Salida	Notice / Aviso	441
No Exit / No Hay Salida	-	443
No Firearms Allowed On Company Grounds	-	547
No Firearms Allowed On Premises	Notice	521
No Firearms Allowed On Premises / No Se Pe...	Notice / Aviso	441
No Firearms Allowed On This Property / No...	Notice / Aviso	441
No Firearms Allowed On This Property / No...	-	443
No Firearms No Knives No Drugs No Alcohol...	-	418
No Firearms Or Weapons Allowed On This Pro...	-	521
No Flammable Liquids Beyond This Point	Danger	455
No Foil Or Metal In This Machine This Mach...	Caution	541
No Food Or Beverage Allowed	-	547
No Food Or Beverage Allowed In This Area	-	547
No Food Or Drink Beyond This Point	Notice	518
No Forklifts Allowed In This Area	-	517
No Fumar	Peligro	439
No Fumar	-	443
No Fumar, No Producir Llamas Ni Chispas	Peligro	439
No Gasoline Or Fuel In Unauthorized Contai...	-	459
No Goggles No Work	Notice	537
No Guns Allowed Beyond This Point...	-	557
No High Heel, Open Toe, Open Heel Or Tenni...	-	547
No Idling Diesel-Powered Vehicles Over 5 T...	-	574
No Idling Turn Your Engines Off And Protec...	-	574
No Jewelry No Piercings No Exposed Cuts...	Notice	528
No Left Turn	-	574
No Lift Trucks	Notice	515
No Lift Trucks Beyond This Point	-	571
No Lift Trucks Beyond This Point...	Notice	515
No Loitering	-	418
No Loitering On This Property	-	557
No Loitering Police Take Notice	-	557
No Loitering Soliciting Skateboards Roller...	-	557
No Loose Clothing While Operating This Mac...	Danger	512
No Operar Sin Protecciones	Precaucion	435
No Outlet	-	574
No Parking	Notice	432
No Parking	Notice	560
No Parking	Restricted Area	560
No Parking	-	558
No Parking	-	562
No Parking / No Estacionarse	Notice / Aviso	441
No Parking 7Am-7Pm Except Electric Vehicle...	-	565
No Parking Any Time	-	562
No Parking Any Time Sign	-	562
NO PARKING AT ANY TIME	-	558
No Parking Between Signs	-	562
No Parking Beyond This Point	-	562
No Parking Beyond This Sign	-	562
No Parking Bus Stop	-	562
No Parking Company Vehicles Only	-	562
No Parking Doctors Only	-	562
No Parking Except Electric Vehicles	-	565
No Parking Except On Shoulder	-	562
No Parking Except Sundays And Holidays	-	562
No Parking Except While Charging	-	565
No Parking Fire Hydrant	-	562
No Parking Fire Lane	-	562
No Parking Fire Lane / No Estacionarse Zon...	-	443
No Parking Fire Lane Keep Clear At All Tim...	-	562
No Parking Fire Lane Police Enforced	-	562
No Parking Fire Lane Sign	-	562
No Parking Fire Station	-	562
No Parking Here To Corner	-	562
No Parking In This Block	-	563
No Parking Keep Area Clear At All Times	-	563
No Parking Loading Zone	-	563
No Parking On Pavement	-	563
No Parking Police Cars	-	563
No Parking School Days	-	563
No Parking Service And Delivery Area	-	563
No Parking Sign	-	562

Legend Text	Header	Pg
No Parking Symbol	-	562
No Parking This Side	-	563
No Parking This Space Is Reserved	-	563
No Pedestrian Crossing	-	574
No Pedestrian Traffic	Danger	512
No Pedestrian Traffic	-	574
No Pedestrian Traffic Accident Will Result...	Danger	429
No Pets	-	418
No Phones Cameras Or Other Electronic Devi...	Notice	555
No Public Restrooms	-	545
No Riders	-	571
No Roof Access	-	482
No Se Permiten Armas, En Conformidad Con...	-	443
No Smoking	Caution	522
No Smoking	Danger	430
No Smoking	Danger	522
No Smoking	Warning	523
No Smoking	-	524
No Smoking (Floor Sign)	-	497
No Smoking - No Eating	-	524
No Smoking (Braille w/Picto)	-	447
No Smoking / No Fumar	Danger / Peligro	439
No Smoking / No Fumar	-	443
No Smoking Allowed	-	524
No Smoking Allowed In This Building At Any...	-	524
No Smoking At Any Time	-	524
No Smoking Battery Charging Emits Hydrogen...	Danger	455
No Smoking Beyond This Door	Danger	522
No Smoking Beyond This Door	-	525
No Smoking Beyond This Point	Caution	522
No Smoking Beyond This Point	Danger	430
No Smoking Beyond This Point	Danger	522
No Smoking Beyond This Point	Warning	523
No Smoking Beyond This Point	-	525
No Smoking Beyond This Point. / No Fumar...	Caution / Precaucion (ANSI)	435
No Smoking Except In Designated Areas	-	525
No Smoking Except In Designated Smoking...	Danger	523
No Smoking Flammable Materials	Danger	523
No Smoking In Office Area	-	525
No Smoking In This Area	Danger	525
No Smoking In This Area	-	433
No Smoking In This Area	-	525
No Smoking In This Building	Danger	523
No Smoking In This Building	-	525
No Smoking In This Building By Order Of Go...	-	525
No Smoking In This Building It's The Law...	-	525
No Smoking In This Building.	Danger	523
No Smoking In This Facility	-	525
No Smoking In Trailers And Dock Area	Danger	523
No Smoking Matches Or Open Lights	Danger	523
No Smoking Matches Or Open Lights	-	525
No Smoking No Flames No Sparks	Danger	523
No Smoking No Open Flames	Caution	522
No Smoking No Open Flames	Oxygen	456
No Smoking No Open Flames No Sparks	Danger	523
No Smoking No Open Flames No Sparks / No...	Danger / Peligro	439
No Smoking No Open Flames No Sparks...	Danger	429
No Smoking No Open Flames No Sparks...	Danger	430
No Smoking No Open Flames No Water Reactive...	Danger	523
No Smoking On Premises	-	525
No Smoking On School Grounds	-	525
No Smoking On Stairway	-	525
No Smoking On These Premises	-	525
No Smoking On This Property	-	525
No Smoking Or E-Cigarettes.	Danger	522
No Smoking Or Open Flames	-	525
No Smoking Or Open Lights Within Feet	Danger	523
No Smoking Or Open Lights Within Feet	Danger	523
No Smoking Or Tobacco Products In This Facility	-	525
No Smoking Oxygen In Use	Danger	523
No Smoking Picto	-	496
No Smoking Picto	-	524
No Smoking Stop Engine When Refueling	-	572
No Smoking This Area	-	525
No Smoking To Report Violations Call: _____	-	526
No Smoking Turn Off Engine	Warning	524
No Smoking Turn Off Ignition	Danger	523
No Smoking Under Penalty Of Dismissal	Notice	523
No Smoking Under Penalty Of Law	-	526
No Smoking Unless You'Re On Fire	Notice	498
No Smoking Violation Will Result In Discip...	Notice	523
No Smoking Violators Are Subject To Fine....	-	526

Sign Legend Index

BradyID.com/s36

Legend Text	Header	Pg
No Smoking Within ___ Feet	-	526
No Smoking Within 15 Feet Of Building Entr...	Danger	523
No Smoking Within 20 Feet Of Building Entr...	Danger	523
No Smoking Within 30 Feet Of Building Entr...	Danger	522
No Smoking Within 50 Feet	Warning	524
No Smoking Within 50 Feet	-	526
No Smoking, Eating Or Drinking In This Are...	Warning	433
No Smoking, Matches Or Open Lights	Warning	524
No Smoking, Matches Or Open Lights.	Danger	430
No Smoking, No Open Flames, No Sparks.	Danger	430
No Smoking, Or Open Lights Within ___ Feet.	Danger	430
No Smoking.	Caution	422
No Smoking.	Danger	429
No Smoking.	Danger	430
No Smoking, Oxygen In Use.	Danger	430
No Solicitation	-	418
No Solicitation Or Distribution Of Materia...	Notice	416
No Soliciting	Notice	416
No Soliciting	Notice	432
No Soliciting No Loitering No Trespassing...	-	557
No Solicitors Allowed	-	574
No Steps	Caution	422
No Steps	Caution	507
No Stopping Fire Lane	-	563
No Text	-	485
No Text	-	521
No Text	-	522
No Text	-	545
No Text	-	547
No Texting While Driving	-	574
No Thoroughfare	Restricted Area	416
No Through Traffic	-	574
No Thru Traffic	-	574
No Tractor Trailers	-	575
No Trespassing	Caution	412
No Trespassing	Danger	414
No Trespassing	Notice	416
No Trespassing	Notice	432
No Trespassing	Restricted Area	555
No Trespassing	Warning	417
No Trespassing	-	418
No Trespassing	-	575
No Trespassing / Prohibido El Paso	Notice / Aviso	441
No Trespassing / Prohibido El Paso	Warning / Advertencia	442
No Trespassing Admittance Limited To Emplo...	-	418
No Trespassing Authorized Personnel Only	Danger	414
No Trespassing Construction Area Violators...	-	469
No Trespassing On This Property Under Pena...	Danger	414
No Trespassing On This Property Under Pena...	Notice	416
No Trespassing Private Road	-	557
No Trespassing Under Penalty Of Law	-	557
No Trespassing Under Penalty Of Law...	Restricted Area	555
No Trespassing Under Penalty Of The Law	-	418
No Trespassing Vendors & Visitors Must Reg...	-	557
No Trespassing Violators Will Be Prosecute...	-	418
No Trespassing Violators Will Be Prosecute...	-	444
No Trespassing Violators Will Be Prosecute...	-	575
No Trespassing.	Danger	430
No Trespassing.	Warning	433
No Trespassing, Authorized Personnel Only...	Danger	430
No Truck Drivers Beyond This Point	Notice	571
No Truck Parking	-	563
No Trucks	-	575
No Trucks Or Trailers	-	575
No Trucks Picto	-	575
No Turkeys Allowed	-	498
No Turn Around	-	575
No U-Turn Picto	-	575
No Unauthorized Personnel Beyond This Point	Restricted Area	417
No Vehicles Beyond This Point	-	575
No Welding Or Open Flames	Danger	486
No Whining	-	498
Nobody Notices What I Do Until I Don't Do...	-	498
Noise Area May Cause Hearing Loss Use Prop...	Caution	531
Noise Area May Cause Hearing Loss Use Prop...	Warning	538
Non-Flammable Gas	-	459
Non-Flammable Gas	-	464
Non-Flammable Gas 2	-	464
Non-Hazardous Materials Only	Notice	456
Non-Permit Confined Space Authorized Person...	Danger	430
Non-Permit Confined Space Authorized Person...	Danger	468
Non-Permit Confined Space Authorized Person...	Danger / Peligro	437
Non-Permit Confined Space Keep Out Unless...	Caution	422

Legend Text	Header	Pg
Non-Permit Confined Space Keep Out Unless...	Caution	466
Non-Permit Confined Space, Authorized Pers...	Danger	430
Non-Permit Confined Space, Keep Out Unless...	Caution	422
Non-Potable Water	Notice	456
Non-Potable Water	Warning	457
Non-Potable Water Do Not Drink	Caution	449
Non-Potable Water Do Not Drink	Danger	455
Non-Potable Water Do Not Use For Drinking...	Danger	455
Non-Potable Water Not For Drinking Or Cook...	Notice	456
Non-Potable Water Not For Drinking Or Cook...	Notice / Aviso	440
Non-Potable Water Not To Be Used For Drink...	Notice	456
Non-Potable Water, Do Not Drink, / Agua No...	Danger / Peligro	436
Non-Potable Water, Do Not Drink, May Resul...	Caution	422
Non-Potable Water, Do Not Use For Drinking...	Danger	430
Not A Fire Exit	Warning	475
Not A Fire Exit	Warning	486
Not A Pedestrian Walkway Fork Trucks Only	Danger	415
Not A Step	Caution	422
Not A Step	Caution	507
Not An Emergency Exit	-	492
Not An Entrance	Notice	416
Not An Entrance	Restricted Area	555
Not An Exit	Notice	416
Not An Exit	-	478
Not An Exit	-	482
Not An Exit	-	478
Not An Exit / No Es Salida	-	443
Not Consumable	-	517
Not Flammable	Notice	486
Not Odorized	-	459
Not Responsible For Cars Or Personal Prope...	-	561
Not Responsible For Theft Or Damage To Veh...	-	557
Not Responsible For Theft Or Damage To Veh...	-	561
Notice All Activities Monitored By Video...	-	557
Notice Carrying A Concealed Handgun Is Pro...	Notice	521
Notice Do Not Throw Smoking Material In Wa...	-	526
Notice No Trespassing Loitering Soliciting...	-	557
Notify Health Physics Prior To Entry	-	543
Nutrition	-	503

O

Ob Clinic	-	503
Office	-	471
Office	-	478
Official Parking Only	-	563
On Bridge	-	563
On The Job Safety Begins Here	Think	553
On The Job Safety Begins Here	-	548
Oncology	-	503
One Lane Closed Ahead	-	569
One Lane Road Ahead	-	569
One Way	-	478
One Way	-	575
One Way Do Not Enter	-	575
Only Authorized Personnel Allowed To Opera...	Caution	507
Only Authorized Personnel Allowed To Opera...	-	517
Only Authorized Personnel Are Allowed To...	-	418
Only Authorized Persons To Enter This Area	Notice	416
Only Authorized Persons To Enter This Area...	Restricted Area	555
Only Authorized Vehicle Or Foot Traffic...	-	418
Open Door Slowly	Caution	470
Open Door Slowly / Abrir La Puerta Lentame...	Caution / Precaucion	434
Open Hole	Danger	512
Open Hole Stay Clear: Fall Will Result In...	Danger	430
Open Pit	Caution	507
Open Pit	Danger	512
Open Pit	Danger	558
Open Pit Stay Clear, Fall Will Result In...	Danger	430
Open Slowly	Caution	507
Open Slowly, May Cause Injury.	Caution	422
Open This Valve In The Event Of Fire...	-	492
Open Trench	Danger	513
Open Trench, Fall Will Result In Severe In...	Danger	430
Operation By Authorized Personnel Only	Danger	513
Operations Dept.	-	471
Operator Must Wear Ear Protection In This...	Notice	537
Ophthalmology	-	503
Organic Peroxide 5.2	-	464
Osha Info	-	501
Osha Regulations Area In Front Of Electric...	Caution	472
Others Are Depending On You Don't Take...	Be Careful	553
Our Aim No Accidents	Think	553
Our Goal No Accidents	-	548

Sign Legend Index

BradyID.com/s36

Legend Text	Header	Pg
Out	-	471
Out Of Order	-	517
Out Of Service / Fuera De Servicio	Danger / Peligro	438
Out Of Service For Repairs	-	517
Outpatient	-	503
Outpatient Parking Only	-	563
Overhead Conveyor	Danger	513
Overhead Crane Area Proceed With Caution	-	517
Overhead Equipment	Caution	507
Overhead Hoist	Danger	513
Overhead Machinery	Danger	513
Overhead Power Lines	Danger	474
Overhead Power Lines / Lineas De Electrici...	Danger / Peligro	438
Overhead Power Lines. Contact Will Result...	Danger	430
Overhead Work	Caution	507
Overhead Work Proceed With Caution. May...	Caution	422
Oxidizer 5.1	-	464
Oxidizer Picto 5.1	-	464
Oxidizer Picto 5.2	-	464
Oxygen 2	-	464
Oxygen Deficient Confined Space	Danger	468
Oxygen Empty Cylinders	-	459
Oxygen Full Cylinders	-	459
Oxygen In Use	-	526
Oxygen, Compressed	-	462
P		
Pacemaker Wearer Do Not Enter This Room...	Danger	430
Pacemaker Wearer Do Not Enter This Room...	Danger	541
Pacemaker Wearers Do Not Proceed Through...	-	543
Paint Vault	-	459
Paper Only	-	544
Parallel Parking	-	563
Paramedic Parking Only	-	563
Park At Angle	-	563
Park At Your Own Risk	-	563
Park At Your Own Risk Company Not Responsible...	-	557
Park In Assigned Spaced Only	-	563
Parking	-	567
Parking \$50 To \$300 Fine	-	567
Parking By Disabled Permit Only	-	567
Parking Facilities Under Camera Surveillan...	Notice	561
Parking For Customers Only	-	563
Parking Lot May Be Slippery When Icy Or We...	Caution	422
Parking Lot May Be Slippery When Icy Or We...	Caution	570
Parking Lot Rules No Firearms No Knives No...	-	571
Parking Permit Required	-	567
Parking Permits Are Required In This Area...	Security Notice	555
Parking Vehicle ID Required	-	567
Parking With D.M.V. Disabled Permit Only...	-	567
Passage To This Fire Hose Must Be Kept...	Notice	518
Pathology	-	503
Ped Xing	-	575
Pedestrian Crossing Ahead	-	575
Pedestrian Traffic Only	-	496
Pedestrian Traffic Only	-	517
Pedestrian Traffic Only (Floor Sign)	-	497
Pedestrians And Bicycles Prohibited	-	575
Pedestrians Picto	-	575
Pediatrics	-	503
People Working	Caution	508
People Working Above	Danger	513
Permission To Use Scaffold Shall Be Obtain...	Warning	469
Permit Parking Only Lot Is Patrolled	-	563
Permit Parking Only Violators Will Be Towe...	-	563
Permit Required Confined Space Do Not Enter...	Danger / Peligro	439
Permit-Required Confined Space Do Not Enter	Danger	468
Personal Eyewash	Safety First	494
Personal Eyewash Keep Area Clean	-	495
Personal Protection Required In This Area	Notice	537
Personal Protective Clothing Is To Be Worn...	Caution	449
Personal Protective Equipment Is Provided...	-	539
Personal protective equipment required beyond...	Caution	559
Personal Protective Equipment Required...	Caution	532
Personal Protective Equipment Stored Here	-	539
Persons Not Assigned To This Area Must Obtain...	Restricted Area	417
Pesticide Storage Area	Warning	457
Pesticide Storage Area All Unauthorized...	Danger	455
Pesticide Storage Authorized Personnel Onl...	Danger	415
Pesticides	Caution	449
Pesticides In Use Do Not Enter	Danger	455
Pet	-	503
Pg Iii 6	-	464

Legend Text	Header	Pg
Pharmacy	-	503
Phenol	-	462
Phone	-	501
Phosphoric Acid	-	462
Photography Is Not Allowed Unless Authoriz...	-	547
Physical Therapy	-	503
Physician Parking Only	-	563
Pick-Up And Drop-Off Only No Parking	-	563
Pinch Point	Warning	516
Pinch Point	-	517
Pinch Point Keep Hands Clear	Caution	422
Pinch Point Keep Hands Clear Moderate Inju...	Caution	423
Pinch Point Watch Your Hands	Danger	513
Pinch Point Watch Your Hands Keep Hands...	Danger	430
Pinch Points / Punto De Agarre	Danger / Peligro	439
Pinch Points Watch Your Hands	Danger	430
Pinch Points Watch Your Hands. Serious Inj...	Danger	430
Pitch In Keep This Place Clean	-	520
Pitch In!	-	520
Pitch In! Help Keep Our Plant Clean!	-	544
Pitch In! Put Trash In Its Place	-	520
Place All Refuse In Can	-	520
Place Cigarettes, Cigar Butts And Ashes In...	Notice	519
Play It Safe	-	549
Please Do Not Litter / Favor De No Tirar...	-	443
Please Do Not Spit On The Floor	Safety First	519
Please Excuse Our Appearance We Are Remode...	Notice	469
Please Excuse Our Appearance While We'Re U...	-	469
Please Extinguish Before Entering	-	526
Please Flush After Each Use / Favor De Jal...	-	443
Please Keep Door Closed At All Times	-	418
Please Keep This Door Closed	-	418
Please No Smoking In This Area	-	526
Please Ring Bell	Notice	571
Please Turn Out Lights When Not In Use	Notice	542
Please Wash Hands Before Returning To Work	-	545
Please Wear Your Seat Belt	-	575
Please Wipe Your Feet Upon Entering	Notice	519
Please.... Deposit All Sanitary Napkins In...	-	528
Please.... Do Not Throw Rubbish In Urinals	-	528
Please.... Flush After Using	-	519
Please.... Flush After Using	-	528
Please...Don't Take Food That Doesn't Belong...	-	520
Please...Keep Off The Grass	-	418
Poca Altura	Peligro	439
Poison	Danger	455
Poison / Veneno	Danger / Peligro	440
Poison 6	-	464
Poison Gas 2	-	464
Poison Keep Out	Danger	455
Poison Picto	-	459
Poison Picto 2	-	464
Poison Picto 6	-	464
Poison Storage Area All Unauthorized Perso...	Danger	455
Poison Storage Area All Unauthorized Perso...	Danger / Peligro	436
Poisonous Gas Hydrogen Sulfide	Danger	455
Poisonous Gas Storage	Danger	455
Poisonous Gas. Hydrogen Sulfide. Breathing...	Danger	430
Positively No Admittance Except To Employe...	-	418
Positively No Smoking	Danger	523
Positively No Smoking	-	526
Positively No Smoking Allowed On These...	Notice	523
Positively No Smoking Beyond This Point	Safety First	523
Possible Hydrogen Sulfide Gas Present	Caution	449
Potassium Hydroxide	-	462
Potassium Perchlorate	-	462
Potassium Permanganate	-	462
Potential Biohazard Present	Caution	445
Ppe Required	Caution	532
Ppe Required (w/ 4-6 Pictos)	Caution	532
Ppe Required Hard Hat Hearing Protection...	Caution	532
Ppe Required Hard Hat Safety Glasses Fr Suit...	Caution	532
Ppe Required Hard Hat Safety Glasses Hearing...	Caution	532
Ppe Required Hard Hat Safety Glasses Safety...	Caution	532
Ppe Required Safety Glasses Hearing Protec...	Caution	532
Practice Good Housekeeping A Place For...	-	520
Pregnant Women Should Not Enter	Caution	449
Prevent Static Spark Discharge Use Ground...	Caution	449
Prevent Static Spark Discharge. Use Ground...	Caution	423
Primary Escape Route	-	485
Private Drive	-	575
Private Keep Out	-	418
Private No Trespassing	Restricted Area	555

Sign Legend Index

BradyID.com/s36

Legend Text	Header	Pg
Private No Trespassing	-	418
Private Parking Violators Will Be Towed...	-	563
Private Property Authorized Personnel Only	-	418
Private Property Keep Out	Notice	416
Private Property Keep Out	Security Notice	555
Private Property Keep Out	-	418
Private Property Keep Out / Prohibido El Paso...	Notice / Aviso	441
Private Property No Dumping	-	419
Private Property No Hunting Fishing Trespass...	-	419
Private Property No Hunting No Trespassing...	-	419
Private Property No Hunting Or Trespassing...	-	419
Private Property No Hunting Or Trespassing...	-	444
Private Property No Loitering Soliciting...	-	557
Private Property No Parking... Etc	-	563
Private Property No Skateboards Bicycles...	-	419
Private Property No Soliciting Loitering...	-	419
Private Property No Trespassing	-	419
Private Property No Trespassing	-	575
Private Property No Trespassing Loitering	-	419
Private Property No Trespassing Violators...	-	444
Private Property No Trespassing Violators...	-	557
Private Property No Unauthorized Parking	-	563
Private Property Trespassers Will Be...	Security Notice	555
Private Property Trespassers Will Be...	-	419
Private Property Unauthorized Persons...	-	419
Private Property Violators Will Be Prosecu...	Notice	416
Private Road	-	575
Private Road Do Not Enter	-	419
Private Road No Thru Traffic	-	575
Private Vehicles Are Not Permitted To Park...	Notice	558
Problems Next Office	Notice	498
Production Area All Through Traffic Use De...	-	497
Production Dept.	-	471
Prohibido El Paso	Advertencia	442
Prohibido El Paso	Aviso	441
Prohibido El Paso A Personal No Autorizado	Area Restringida	442
Promote Safety Through Good Housekeeping	-	520
Propane	Warning	457
Propane Cylinders	Danger	455
Propane Cylinders. Handle With Care.	Danger	430
Propane Gas	Danger	455
Propane Gas	-	462
Propane Gas. Flammable.	Danger	430
Proper Hand Protection Is Required For All...	-	547
Protect Your Eyes Wear Safety Glasses	-	540
Protective Clothing Must Be Worn In This...	-	540
Protective Clothing Picto	-	532
Protective Clothing Required In This Area	Caution	532
Protective Clothing Required In This Area	Danger	535
Protective Clothing Required In This Area	Notice	537
Protective Equipment Is Available See Your...	Safety First	538
Protective Equipment Must Be Worn In This...	Danger	535
Protective Equipment Required Affix Pictog...	Caution	532
Protective Wear Required In This Area	Caution (ANSI)	424
Pull	-	478
Pull To Open w/Right Up Arrow Picto	-	478
Pursuant To Section 30.06, Penal Code...	-	521
Push	-	478
Push Bar To Open	-	478
Push To Open	-	478
Put Things In Their Proper Places-And You...	Please	519
Put Tools Back In Their Proper Place	Notice	519
Put Tools Back In Their Proper Place	Safety First	515

Q

Quality - Only Your Best Will Do	-	549
Quality Is Our Most Important Product	-	517
Quarantine Area	Caution	449

R

Radiation	Danger	542
Radiation Area	Caution	423
Radiation Area (Floor Sign)	-	497
Radiation Area Authorized Personnel Only...	Caution / Precaucion	434
Radiation Caution Lock Out Radiation Sourc...	-	543
Radiation High Radiation Area Personnel...	-	543
Radiation Radioactive Waste Prohibited...	-	543
Radiation Radiologically Controlled Area...	-	543
Radiation Restricted Area	-	543
Radiation/Contamination Area	-	543
Radio Frequency Fields No Trespassing	Notice	542
Radioactive 7	-	464
Radioactive Equipment In This Area	Caution	541

Legend Text	Header	Pg
Radioactive Materials Area	-	543
Radiology	-	503
Rail Car Wheels Must Be Chocked	Caution	570
Railroad Crossing Picto	-	575
Railroad Danger Crossing	-	575
Raw And Cooked Foods Must Not Be Stored...	-	517
Rcra Accumulation Area	-	460
Read Instructions Before Operating	Caution	508
Receiving	-	478
Receiving	-	572
Receiving Department	-	572
Receiving Hours Am- Pm	-	572
Recyclable Aluminum Cans Only	-	544
Recyclable Aluminum Cansonly	-	544
Recyclable Cans Only	-	544
Recyclable Metals Only	-	544
Recyclable Paper Only	-	544
Recyclable Plastic Only	-	544
Recyclable Save Our Resources Aluminum...	-	544
Recyclable Save Our Resources Cardboard...	-	544
Recyclable Save Our Resources Glass...	-	544
Recyclable Save Our Resources Paper...	-	544
Recyclable Save Our Resources Plastic...	-	544
Recyclable Waste Only	-	544
Recycle / Recycle	-	444
Recycle Can	-	544
Recycle Symbol Picto	-	544
Registration	-	503
Remember The Next Inspector Is Our Custome...	-	517
Remove All Doubt Lock It Out	-	505
Report All Accidents	Safety First	553
Report All Accidents No Matter How Small...	Safety First	494
Report All Accidents To Your Supervisor...	-	495
Report All Injuries At Once	Notice	432
Report All Injuries At Once	Notice	493
Report All Injuries No Matter How Slight...	Safety First	494
Report All Injuries Or Unsafe Conditions...	-	547
Report All Injuries To Your Supervisor	Think	494
Report All Unsafe Conditions To Your Foreman	Safety First	553
Requirement For Entry Shoe Covers Boots...	-	543
Reserved For Customers	-	564
Reserved For Electric Vehicle	-	565
Reserved For Faculty	-	564
Reserved For New And Expecting Mothers	-	564
Reserved For Physicians	-	564
Reserved For School Maintenance Vehicles	-	564
Reserved For Security	-	564
Reserved For Service And Delivery	-	564
Reserved For Visitors Only	-	564
Reserved For World's Greatest Dad	-	564
Reserved Handicapped	-	567
Reserved Parking	-	564
Reserved Parking \$250 Fine	-	567
Reserved Parking \$50 Fine 1St Offense Park...	-	567
Reserved Parking Authorized Personnel Only	-	564
Reserved Parking Handicap Plate Or Permit...	-	567
Reserved Parking Maximum Fine Of \$100...	-	567
Reserved Parking Placard Required	-	567
Reserved Parking Sign	-	567
Reserved Parking Vehicles With Vet Or...	-	567
Reserved Parking Violators Towed Away...	-	564
Reserved Parking...	-	567
Resident Parking Only	-	564
Respirator Picto	-	540
Respirator Required	Caution	532
Respirator Required	Danger	535
Respirator Required In This Area	Danger	535
Respirator Required While Painting Or...	Caution	532
Respirator Storage	-	520
Respirators Are Required At All Times	-	547
Respirators Are Required In This Area	-	547
Respirators Must Be Worn In This Area	Caution	532
Respirators Must Be Worn In This Area	Notice	537
Respirators Must Be Worn In This Area...	Caution	423
Respirators Required Beyond This Point	Danger	535
Respirators Required In This Area / Uso...	Caution / Precaucion	435
Respirators Required In This Area...	Notice	537
Respiratory	-	503
Respiratory Protection Required	-	543
Rest Rooms	-	501
Rest Rooms	-	545
Restricted Are Keep Out	-	557
Restricted Area	Caution	412

Sign Legend Index

BradyID.com/s36

Legend Text	Header	Pg
Restricted Area	Danger	415
Restricted Area	Notice	416
Restricted Area	-	419
Restricted Area All Persons Must Have...	-	419
Restricted Area Authorized Employees Only	Warning	417
Restricted Area Authorized Personnel Only	Notice	416
Restricted Area Authorized Personnel Only	Security Notice	556
Restricted Area Authorized Personnel Only	-	419
Restricted Area Authorized Personnel Only...	Notice / Aviso	440
Restricted Area Get Permission Before...	-	557
Restricted Area Keep Out	Notice	416
Restricted Area No Smoking	-	526
Restricted Area No Smoking At Any Time	Danger	523
Restricted Area No Smoking At Any Time...	Danger	523
Restricted Area.	Danger	430
Restroom	-	545
Restroom (Braille w/Picto)	-	447
Restroom (Braille)	-	447
Restroom Being Cleaned	Do Not Enter	528
Restroom Closed For Cleaning	-	519
Restrooms	-	545
Restrooms/Banos	-	442
Reward For Information Leading To The...	-	557
Right	-	569
Right Arrow Picto	-	485
Right Lane Closed Ahead	-	569
Right Shoulder Closed	-	569
Right To Know Info	-	501
Right To Know Information Available...	Notice	456
Right To Know Information Available...	Notice / Aviso	440
Right To Know Station	-	460
Ring Bell For Service	-	419
Road Closed Ahead	-	569
Road Work Ahead	-	569
Robot In Operation	Danger	513
Robot Moves Without Warning Keep Away	Danger	513
Robot Operating Area Do Not Enter...	Caution	412
Robotic Area Authorized Personnel Only	Danger	415
Rotating Machinery	Danger	513
Rotating Machinery, Proceed With Caution...	Danger	431
Running Man Exit	-	482
Running Man Exit Down	-	482
Running Man Exit Down Left	-	482
Running Man Exit Down Right	-	482
Running Man Exit Left	-	482
Running Man Exit Right	-	482
Running Man Exit Through Lobby	-	482
Running Man Exit To Street	-	482
Running Man Exit Up	-	482
Running Man Exit Up Left	-	482
Running Man Exit Up Right	-	482
Rush Job Calendar	-	498
S		
S.D.S. Info	-	501
Safe Floor Load Limit Not To Exceed ___ Lbs...	Notice	519
Safety & Quality	-	549
Safety & Quality #1 Priorities!	-	549
Safety = Success	-	549
Safety And Quality #1 Priorities	-	549
Safety Belt And A Lifeline Required	Caution	466
Safety Belt Required	Caution	466
Safety Belts Required	Danger	468
Safety Belts Required In This Area	Danger	468
Safety Boots Picto	-	532
Safety Boots Picto	-	540
Safety Dept.	-	471
Safety Equipment Stored Here	Notice	537
Safety First Wear Personal Protective...	Think	538
Safety Footwear Is Required At All Times	-	547
Safety Footwear Is Required In This Area	-	547
Safety Glasses	-	501
Safety Glasses And Hard Hats Required In...	Danger	535
Safety Glasses And Safety Shoes Required...	Notice	537
Safety Glasses Must Be Worn At All Times	Caution	532
Safety Glasses Must Be Worn At All Times	-	547
Safety Glasses Must Be Worn In This Area	-	547
Safety Glasses Must Be Worn When Using...	-	540
Safety Glasses Must Be Worn With Face Shield	Notice	537
Safety Glasses Required	-	496
Safety Glasses Required (Floor Sign)	-	497
Safety Glasses Required Beyond This Point	Caution	532
Safety Glasses Required Beyond This Point	Caution	558

Legend Text	Header	Pg
Safety Glasses Required Beyond This Point	Notice	537
Safety Glasses Required Beyond This Point...	Notice	432
Safety Glasses Required Beyond This Point...	Notice / Aviso	441
Safety Glasses Required In This Area	Caution	532
Safety Glasses Required In This Area	Danger	535
Safety Glasses Required In This Area	Notice	537
Safety Glasses Required In This Area	Safety First	538
Safety Glasses Required In This Area / Uso...	Caution / Precaucion	435
Safety Glasses Required In This Area...	Danger	535
Safety Glasses Required In This Area...	Notice	537
Safety Glasses Safety Shoes And Hard Hats...	Safety First	538
Safety Glasses With Clear Lenses And Side...	-	547
Safety Glasses With Side Shields Must Be...	Caution	533
Safety Gloves Are Required At All Times	-	547
Safety Gloves Are Required In This Area	-	547
Safety Goggles Required	-	496
Safety Goggles Required (Floor Sign)	-	497
Safety Goggles Required In This Area	Caution	533
Safety Harness Required	Danger	468
Safety Has No Quitting Time	-	549
Safety Has No Quitting Time	-	554
Safety Is Everyone's Job	-	549
Safety Is Job #1	-	549
Safety Is Your Responsibility	-	549
Safety Never Hurts	-	549
Safety Now Means No Accidents Later	-	549
Safety Protects People Quality Protects Jobs...	-	549
Safety Shoes Must Be Worn	Warning	538
Safety Shoes Must Be Worn In This Area...	Danger	535
Safety Shoes Required	Caution	533
Safety Shoes Required / Uso Obligatorio...	Caution / Precaucion	435
Safety Shoes Required In This Area	Notice	537
Safety Shoes Required In This Area...	Danger	431
Safety Shower	-	495
Safety Shower	-	496
Safety Shower	-	501
Safety Shower (Floor Sign)	-	497
Safety Shower And Eye Wash Station	Safety First	494
Safety Shower And Eyewash Station	Safety First	494
Safety Shower Keep Area Clear	Emergency	432
Safety Starts With You This Department Has...	-	554
Safety Starts With You!	-	549
Safety Teamwork	-	549
Safety Training Mandatory Do Not Operate...	Caution	508
Safety... Work Safely	Think	553
Safety...Work Safely	Think	553
Safety Harness Required	Danger	468
Safety Glasses, Safety Shoes And Hard Hats...	Notice	537
Salida	-	444
Satellite Storage Area	-	460
Save Energy Close Doors When Not In Use	Notice	542
Save Your Eyes Wear Eye Protection	Notice	537
Scaffold Incomplete Do Not Use	Danger	558
School Crossing Picto	-	575
School Crossing Picto Sign	-	575
Secure All Tanks Chain Cylinders	Caution	423
Secure All Tanks Chain Cylinders	Caution	449
Security Alarm Will Sound If Door Is Opened	Notice	416
Security Alarm Will Sound If Door Is Opened	Restricted Area	555
Security Alarm Will Sound If Door Is Opened	Warning	471
Security Badges Must Be Worn At All Times	Security Notice	556
Security Notice Entering This Facility Is...	-	557
Segregate Waste And Recycle In Appropriate...	-	547
Severe Weather Shelter	-	479
Severe Weather Shelter Area	-	479
Severe Weather Shelter Area	-	501
SEVERE WEATHER SHELTER AREA Sign	-	479
Sewage Water No Drinking, Fishing Or Swimming	Danger	455
Share The Road	-	575
Sharp Objects Gloves Required	Caution	533
Shipping	-	478
Shipping	-	572
Shipping & Receiving	-	572
Shipping And Receiving	-	572
Shipping Department	-	572
Shoe Covers Required	Notice	537
Shorts, Sleeveless Shirts And Un-Tucked...	-	547
Shoulder Work Ahead	-	569
Shower Station	Safety First	494
Shower Station	-	495
Shower Station Emergency Use Only	-	495
Siamese Connection For Fire Dept.	-	492
Side Shield Safety Glasses Required In This Area	Notice	537

Sign Legend Index

BradyID.com/s36

Legend Text	Header	Pg
Sidewalk Closed	-	575
Slippery Floor	Be Careful	529
Slippery Floor	Caution	423
Slippery Floor	Caution	508
Slippery Floor	Warning	516
Slippery Floor. Falls May Result In Injury...	Caution	423
Slippery Trip Hazard	Caution	508
Slippery When Wet	Caution	508
Slippery When Wet	Notice	515
Slippery When Wet / Resbaloso Cuando Esta...	Caution / Precaucion	435
Slippery When Wet. Falls May Result In Inj...	Caution	423
Slow	-	575
Slow Blind Corner Proceed With Caution	-	575
Slow Children	-	576
Slow Children Playing	-	576
Slow Dangerous Intersection	-	576
Slow Down Pedestrian Traffic	Caution	570
Slow Down Pedestrian Traffic Accident May...	Caution	423
Slow High Traffic Area	-	576
Slow Pedestrian Crossing Sign	-	576
Slow Proceed With Caution	-	576
Slow Sound Horn	Caution	570
Slow Speed Bump	-	576
Slow. Sound Horn To Avoid Injury.	Caution	423
Smoke Barrier Please Keep Closed...	-	492
Smoking Allowed In This Area	Notice	527
Smoking In Designated Areas Only	-	526
Smoking In Elevator Prohibited	-	526
Smoking Is Prohibited Except In Designated...	-	526
Smoking Lounge	-	527
Smoking Permitted	-	526
Smoking Permitted In This Area	-	527
Smoking Permitted In This Area.	Notice	527
Smoking Prohibited Except In Designated...	-	526
Smoking Prohibited In This Area	-	526
Smoking Will Result In Disciplinary Action	-	526
Social Services	-	503
Sodium Hydroxide	Danger	455
Sodium Hydroxide	-	462
Sodium Hypochlorite	Danger	455
Sodium Hypochlorite Chemical Information	-	460
Solo Empleados	Aviso	441
Solo Personal Autorizado	Aviso	441
Sorry, We'Re Closed	-	419
Sound Horn Before Entering	Notice	571
Sound Horn Proceed Slowly	Caution	570
Sound Horn Proceed Slowly / Toque La Bocin...	-	444
Sound Horn Proceed Slowly. Accident May...	Caution	423
Sound Horn. Proceed Slowly. Accident May...	Caution	423
Space Or Group Of Spaces Monitored By Heat...	-	485
Space Protected By Halon	-	485
Speed Bump Ahead	-	576
Speed Limit 10 Mph	-	576
Speed Limit 10 Sign	-	576
Speed Limit 15 Mph	-	576
Speed Limit 15 Sign	-	576
Speed Limit 20 Mph	-	576
Speed Limit 25 Mph	-	576
Speed Limit 5 Mph	-	576
Speed Limit 5 Sign	-	576
Spill Control Station	-	460
Spill Response Equipment	Emergency	432
Spill Response Equipment	-	501
Spill Sorbent Storage	-	460
Spill Station	-	501
Spill-Kit Station	-	460
Spitting Is Unlawful Unsanitary Unhealthy...	-	528
Spontaneously Combustible 4	-	464
Spray Paint Booth Paint Fumes May Be Present	-	460
Sprinkler Control Valve	-	492
Sprinkler Control Valve	-	492
Sprinkler Drain Valve	-	492
Sprinkler Fire Alarm	-	492
Sprinkler Stop Valve	-	492
Sprinkler Valve	-	478
Sprinkler Valve	-	492
Sprinkler Valve Do Not Close Unless Author...	-	492
Sprinkler Valve Keep Open	-	492
Staff Parking Only	-	564
Stairs	-	478
Stairs	-	479
Stairs To Fire Exit	-	479
Stairway	Caution	508

Legend Text	Header	Pg
Stairway	-	479
Stairway (Braille w/Picto)	-	447
Stand Clear Of Door	Caution	470
Stand Clear Of Door	Caution	508
Stand Clear Of Swing Radius	Caution	508
Standpipe	-	492
Standpipe At Other Stairs	-	492
Standpipe For Fire Department Use Only	-	492
Start Water Spray Picto	-	485
Starts Automatically	Danger	513
Starts Automatically Keep Hands Clear...	Danger	513
Starts Automatically Keep Hands. Clear...	Danger	431
Starts Automatically Proceed With Caution...	Danger	431
State Law Prohibits Smoking Within 8 Feet of This Entrance	-	526
Static Control Area	Caution	472
Static Sensitive Devices: Do Not Enter Without...	Caution	472
Stay Alert	-	549
Stay Alert And Yield To Forklift Traffic	-	547
Stay Alert Don't Get Hurt	Be Careful	553
Stay Back _____ Feet	Caution	508
Stay Clear	Caution	412
Stay Clear	Danger	431
Stay Clear	Danger	513
Stay Clear / No Obstruir El Paso	Danger / Peligro	439
Stay Clear Automatic Equipment May Start...	Caution	423
Stay Clear Automatic Start Equipment	Danger	431
Stay Clear Of Moving Conveyors	Danger	513
Stay Clear Of Swing Radius	Danger	513
Stay Clear Of Swing Radius Moving Equipment...	Danger	431
Stealing Will Lead To Arrest And Prosecution	Warning	556
Steel Toe Shoes Required In This Area	Notice	537
Steel-Toe Safety Footwear Is Required In...	-	547
Step Down	Caution	508
Step Down	Warning	516
Step Up	Caution	508
Step Up	Warning	516
Stop	-	496
Stop	-	568
Stop	-	576
Stop (Floor Sign)	-	497
Stop / Pare	-	444
Stop Ahead	-	576
Stop All Visitors Must Report To Main Offi...	-	572
Stop Authorized Personnel Only Beyond This...	-	572
Stop Brew At Work (Blue)	-	568
Stop Car Connected (Blue)	-	568
Stop Car Connected (Red)	-	568
Stop Check In Here	-	557
Stop Check With Guard Before Entering Plan...	-	572
Stop Check With Guard Before Proceeding	-	572
Stop Crew At Work (Red)	-	568
Stop Ear Protection Required In This Area	-	540
Stop Employees Working (Blue)	-	568
Stop Engine No Smoking	-	526
Stop Exit Only Do Not Enter	-	572
Stop Fires Before They Start Think Fire...	-	492
Stop For Pedestrians In Crosswalk	-	576
Stop For Pedestrians Sign and Stand	-	576
Stop For Vehicle Check	-	576
Stop Hard Hat Required Beyond This Point	-	540
Stop Hearing Protection & Safety Glasses...	-	540
Stop Hearing Protection Required In This...	-	540
Stop Here When Flashing	-	576
Stop Look Before Exiting	-	576
Stop Look Out For Forklifts	-	572
Stop Machine Before Removing Jams	Caution	508
Stop Men At Work	-	572
Stop No Pedestrians Fork Trucks Only	-	572
Stop Pedestrian Crossing	-	576
Stop Pedestrian Crosswalk	-	572
Stop Personal Protective Equipment Require...	-	540
Stop Proceed Slowly	Danger	513
Stop Proceed Slowly	-	572
Stop Proceed With Caution	-	572
Stop Safety Glasses Required Beyond This...	-	540
Stop Sign	-	576
Stop Sound Horn And Proceed With Caution	-	572
Stop Sound Horn Proceed Slowly	-	568
Stop Tank Car Connected	-	568
Stop Tank Car Connected (Blue)	-	568
Stop Tank Car Connected (Red)	-	568
Stop Think Observe Proceed	-	572

Sign Legend Index

BradyID.com/s36

Legend Text	Header	Pg
Stop This Machinery Before Oiling, Wiping...	-	517
Stop Vendors And Visitors. Must Sign In At...	-	419
Stop Your Hand Is Near A Pinch Point	-	517
Stop Your Motor	No Smoking	523
Stop Your Motor	No Smoking	523
Storage Area Flammable Material	Danger	486
Storage Area No Smoking Or Open Flames	Warning	524
Storage Not Permitted In This Area	Warning	457
Storage Not Permitted In This Area.	Warning	433
Storage Room Not An Exit	-	479
Store Full Gas Cylinders Here	Notice	456
Stretcher	-	495
Striped Traffic Sign	-	573
Student Parking Only	-	564
Sudden Stops Or Turns May Cause Loads To...	Caution	570
Sulfuric Acid	Danger	455
Sulfuric Acid Wear Goggles And Protective...	Danger	455
Sulfuric Acid. Contact Will Result In Seve...	Danger	431
Sulfuric Acid. Wear Goggles And Protective...	Danger	431
Surgery	-	503
Sustancias Quimicas Peligrosas	Peligro	439
T		
Taxi Lane	-	577
Teamwork The Necessary Ingredient For Safe...	-	549
Teamwork There Is No 'I' In Teamwork	-	550
Telephone	-	479
Tenant Parking Only	-	564
Thank You For Not Smoking	-	526
Thank You For Not Smoking	-	527
Thank You For Working Safely	-	550
Thank You...I Appreciate Your Not Smoking...	-	527
The Best Safety Device Is A Careful Worker	-	554
The Placement Of Hazardous Waste In This...	Caution	449
The Safe Way Is The Best Way	Be Careful	553
The Safe Way Is The Best Way	Think	554
The Safe Way Is The Only Way	-	550
The Use Of Cameras Or Video Equipment Is...	-	557
The Use Of Tobacco Products In This Facility...	-	527
There Is No Substitute For Safety	Think	554
These Doors Close Automatically	Caution	412
These Doors Must Be Kept Closed	Caution	470
These Premises Are Alarmed	Security Notice	556
These Premises Protected By Closed Circuit...	Notice	416
Think And Work Safely	-	550
Think And Work Safely (Bilingual)	-	550
Think Like I Do	-	498
Think Quality	-	550
Think Safety	-	550
Think Safety	-	554
This Area Closed Off	Caution	412
This area contains a chemical known to the state...	Warning	461
This Area Contains Chemicals Known To The State...	Warning	461
This Area Is Under 24 Hour Tv Surveillance...	Notice	555
This Area Is Under 24 Hour Tv Surveillance...	Notice / Aviso	440
This Area Is Under 24 Hour Tv Surveillan...	-	557
This Area Patrolled By Attack Dogs	Warning	556
This Area Protected By Halon 1301 Fire Ext...	-	492
This Company Has Worked [#] Days Without...	-	554
This Company Promotes A Drug Free Environm...	-	554
This Company Promotes A Smoke Free Environ...	-	554
This Department Has Worked [#] Days Without...	-	554
This Device Controlled By An Energy Manage...	-	505
This Disconnect Does Not Remove All Power...	Warning	505
This Disconnect Does Not Remove All Power...	-	505
This Door For Emergency Exit Only	-	479
This Door Is Alarmed	Security Notice	556
This Door Must Be Kept Closed	Caution	470
This Door Must Be Kept Closed	-	471
This Door To Remain Unlocked During Business...	Notice	470
This Door To Remain Unlocked During Business...	-	471
This Door To Remain Unlocked During Working...	-	471
This Elevator Is For Freight Only Not For...	Notice	515
This Elevator Maximum Capacity _____ Lbs...	-	517
This Enclosure Contains High Voltage Elect...	Danger	415
This Enclosure Contains High Voltage Elect...	Danger	431
This Equipment Has Been Locked Out	Caution	504
This Equipment Is Supplied With Two Electr...	Danger	431
This Equipment Is Supplied With Two Electr...	Danger	513
This Equipment Must Be Locked Out When Work...	Caution	504
This Equipment Operates From Remote Control	Danger	513
This Equipment Starts Automatically	Danger	513
This Equipment Starts Automatically	-	517

Legend Text	Header	Pg
This Equipment Starts Automatically / Este...	Danger / Peligro	437
This Equipment Starts Automatically Stay...	Danger	431
This equipment starts automatically. Stay clear.	Danger	559
This Equipment Starts Automatically...	Danger	431
This Facility Permits Smoking And Tobacco. Smoking...	Warning	461
This Gate Must Be Kept Locked	Notice	470
This Is A Drug-Free Workplace	Notice	416
This Is A Drug-Free Workplace / Esta Es Un...	Notice / Aviso	440
This Is A No Smoking Lunch Area	Notice	523
This Is A Safety Helmet Area	-	540
This Is A Smoke Free Facility Thank You...	-	442
This Is A Smoke Free Facility Thank You...	-	527
This Is A Smoke Free Tobacco Free Facility...	-	527
This Is A Smoke Free Work Place	-	527
This Is A Smoke Free Workplace	-	547
This Is A Smoke-Free Building	-	527
This Is A Smoke-Free Campus Smoking...	-	527
This Is Your Home Five Days Of The Week...	-	528
This Is Your Lunch Area Keep It Clean	Please	519
This Is Your Wash Room Please Help Keep...	-	520
This Is Your Wash Room Please Help Keep...	-	528
This Is Your Washroom Help Keep It Clean...	-	442
This Is Your Washroom Help Keep It Clean...	-	528
This Is Your Washroom Please Help Keep It...	-	528
This Job Has Worked [#] Days Without A...	-	554
This Line Carries High Voltage Damage To...	Danger	474
This Lunchroom Is Here For Your Convenienc...	-	520
This Machine Is Automatically Controlled...	Caution / Precaucion	434
This Machine Must Be Locked Out Prior To...	Caution	423
This Machine Must Be Locked Out Prior To...	Caution	504
This Machine Starts And Stops Automatically	Danger	513
This Machine Starts And Stops Automatically...	Danger	431
This Machine Starts And Stops Automatically...	Danger / Peligro	437
This Machine Starts Automatically	Danger	513
This Machine Starts Automatically	Warning	516
This Machine Starts By Remote Control	Caution	508
This Magnet Is Always On	Danger	542
This Motor Starts By Remote Control	Caution	508
This Plant Has Worked [#] Days Without...	-	554
This Product May Contain A Chemical Know To...	Warning	461
This Property Is Protected By Electronic...	Security Notice	556
This Property Protected By Electronic Surveillance	Notice	416
This Property Protected By Electronic Surveillance	Restricted Area	555
This Property Protected By Security Patrol	Warning	556
This Restroom Is Here For Your Convenience...	-	520
This Room Is Protected By Halon Fire Extin...	Caution	486
This Sign Is Posted To Comply With The Requirements...	Warning	461
This Sink Is For Food Wash Only	-	517
This Sink Is For Hand Wash Only	-	517
This Sink Is For Utensil Wash Only	-	517
This Space Must Be Kept Clear At All Times	Caution	518
This Space Must Be Kept Clear At All Times...	Caution / Precaucion	434
This Vehicle Stops At All Railroad Crossin...	Notice	571
This Water Is Safe To Drink	Notice	456
This Water Is Unsafe To Drink	Notice	432
This Way Out	-	479
This Way To Office	-	479
Thou Shalt Not Park Here	-	564
Thru Truck Route	-	577
To Open Break Glass And Pull Chain	-	492
To Sprinkler Control Valve	-	492
To Use Fire Extinguisher	-	501
Today	Be Careful	553
Today's Threat Advisory:	-	557
Toluene	-	462
Tornado Shelter	Notice	479
Tornado Shelter	-	479
Tornado Shelter	-	501
Tornado Shelter / Refugio Contra Tornados	-	444
Tow-Away Special Placard Or License Plate...	-	567
Tow-Away Zone	-	564
Toxic 6	-	464
Toxic Chemicals	Danger	455
Toxic Gas 2	-	464
Toxic Gas Do Not Enter When Light Is Flash...	Danger	455
Toxic Materials	Danger	455
Toxic/Hazardous Chemicals Are Used In This...	Caution	449
Trash Goes Here Don't Litter	-	544
Trash Only	-	544
Trash Only / Basura Solamente	-	442
Trespassers Will Be Prosecuted	Notice	416
Trichloroethylene	-	462

Sign Legend Index

BradyID.com/s36

Legend Text	Header	Pg
Tripping Hazard	Caution	508
Tripping Hazard, Falls May Result In Injur...	Caution	423
Truck Drivers Must Chock Wheels And Set...	-	572
Truck Drivers Must Remain With Their Vehic...	Notice	571
Truck Drivers Ring Bell And Wait	Notice	571
Truck Drivers Shut Off Motor Set Brakes...	Notice	571
Truck Drivers Waiting For Loading Or Unloa...	-	572
Truck Entrance	-	577
Truck Must Be Turned Off When Loading	Warning	571
Truck Parking	-	564
Truck Route	-	577
Trucks	-	577
Trucks Entering Highway	-	577
Try To See It Our Way Wear Goggles And...	-	550
Turn Machine Off When Not In Use	Caution	509
Turn Off Battery Charger Before Disconnect...	Danger	474
Turn Off Cellular Phones, Pagers And Other...	Notice	542
Turn Off Lights Conserve Energy	-	544
Turn Off Power Before Working On Machines	Danger	514
Turpentine	-	462
Two Way Feed	Danger	431
Two Way Feed	Danger	514
Two Way Traffic Ahead	-	577

U

Ultrasound	-	503
Ultraviolet Light	Caution	541
Unauthorized Motor Vehicles Prohibited On...	-	557
Unauthorized Parking Mandates \$100 Fee	-	567
Unauthorized Personnel Are Not Permitted...	Notice	416
Unauthorized Personnel Keep Out	Caution	413
Unauthorized Personnel Keep Out	Danger	415
Unauthorized Personnel Keep Out	Warning	417
Unauthorized Personnel Keep Out	Danger	431
Unauthorized Persons Keep Out	Restricted Area	417
Unauthorized Persons Keep Out	-	433
Unauthorized Persons Keep Out / Prohibido...	Restricted Area / Area Restringida	442
Unauthorized Vehicles Prohibited	Security Notice	556
Underground Cable	Danger	474
Underground Cable Call Before Digging...	Warning	474
Underground Live Wire	Danger	474
Unlawful To Operate This Equipment Within...	Caution	472
Unleaded Gasoline	-	462
Unloading Caustic	Danger	455
Unsafe Roof Keep Off	Danger	415
Unsafe To Drink Picto	-	460
Ups Pick Up	-	572
Usar Casco Protector En Esta Area	Peligro	439
Usar El Pasamanos	Precaucion	435
Use Crosswalk	-	577
Use Fuse Puller To Change Fuses	Caution	509
Use Hand Rail	-	517
Use Handrail	Caution	509
Use Handrail	Caution	533
Use Handrail / Usar El Pasamanos	Caution / Precaucion	435
Use Handrail Falls May Result In Injury	Caution	423
Use Lockout Device During Maintenance...	Caution	504
Use Of Cellular Phone Is Prohibited In...	Security Notice	521
Use Of Cellular Phones Not Allowed	-	521
Use Of Cellular Phones Prohibited	-	547
Use Of Safety Belt And Line Required For...	Notice	537
Use Other Door	Caution	413
Use Static Grounding Devices	Caution	472
Use Static Grounding Devices	Warning	474
Used Batteries	Caution	449
Used Oil	-	460
Used Oil Storage Area	-	460
Uso Obligatorio De Casco De Proteccion	Precaucion	435
Uso Obligatorio De Guantes Y Proteccion...	Precaucion	435
Uso Obligatorio De Lentes De Seguridad...	Aviso	441
Uso Obligatorio De Proteccion Auditiva	Precaucion	435
Uso Obligatorio De Proteccion Para La Vist...	Precaucion	435
Utility Work Ahead	-	569

V

Vacate Stall When Charging Completed	-	565
Valve Caps Must Be In Place On Cylinders...	-	460
Van Accessible	-	567
Vapor Respirator Required In This Area	Caution	533
Vehicle Must Be Plugged In	-	565
Vehicles Improperly Parked Subject To...	-	564

Legend Text	Header	Pg
Vehicles Must Come To A Complete Stop...	-	419
Vendors And Visitors Must Register At Main...	Notice	555
Vendors And Visitors Must Register At Main...	Notice / Aviso	440
Very Hot Water	Caution	449
Very Hot Water, Burns Or Injury May Occur...	Caution	423
Video Surveillance In Use On These Premise...	Security Notice	556
Vinyl Acetate	-	462
Vinyl Chloride	-	462
Vinyl Chloride May Cause Cancer Authorized...	Danger	455
Violators Towed Away At Vehicle Owner's ...	-	564
Violators Will Be Fined Min \$150 Handicapp...	-	567
Violators Will Be Towed At Owner's Expense	Warning	560
Visitor Parking	-	564
Visitors Must Report To Office / Los Visitantes...	Notice / Aviso	440
Visitors Must Wear Eye Protection Beyond...	Notice	537
Visitors Must Wear Hard Hats And Safety...	Caution	533
Visitors Obtain Plant Pass In Main Office...	-	419
Visitors Only	Parking	560
Visitors Parking Only	-	564
Visitors Please Report To Office	-	557
Voltage Source	-	505

W

Waiting Area	-	503
Walk Don't Run	Safety First	515
Walk Down Stairs Backwards	Caution	509
Walking Of Dogs Prohibited On This Property	-	419
Warning Fire Equipment Protected From Theft...	-	492
Warning Forklift Traffic	-	496
Warning Forklift Traffic (Floor Sign)	-	497
Warning If You Come In Contact With...	-	460
Warning Radio-Frequency Radiation Hazard...	-	543
Warning Smoking Is Hazardous To Your Health	-	527
Warning Surveillance Zone You Are Being...	-	557
Warning This Area Contains A Chemical Know...	-	461
Warning This Equipment Starts Automaticall...	-	517
Warning This Machine Is Automatically...	Danger	431
Warning This Machine Is Automatically...	Danger	514
Warning This Machine Is Automatically...	-	517
Warning This Property Protected By Security...	-	557
Warning Unlawful To Operate This Equipment...	-	517
Warning! Attack Dogs On Premises...	-	419
Wash And Sanitize Hands Before Starting...	-	528
Wash Hands And Arms Up To The Elbows For...	-	528
Wash Hands Before Leaving This Room...	-	528
Wash Hands Before Returning To Work	Notice	528
Wash Hands Before Returning To Work /Lava...	Notice / Aviso	440
Wash Hands Before Returning To Work /Lava...	Notice / Aviso	559
Wash Hands Before Returning To Work /Lava...	-	443
Wash Hands Before Returning To Work...	-	501
Wash Your Hands Before Leaving As A Sanita...	Notice	528
Wash Your Hands Before Leaving This Room	Notice	528
Wash Your Hands Before Leaving This Room...	Notice / Aviso	440
Wash your hands. Avoid contamination.	Notice	559
Waste Oil	-	460
Waste Oil Storage Area	-	460
Waste Solvent	-	460
Watch For Children	-	577
Watch For Falling Debris	Danger	514
Watch For Falling Debris. Will Result In...	Danger	431
Watch For Lift Trucks	Caution	509
Watch For Lift Trucks / Cuidado Con Los Mo...	Caution / Precaucion	434
Watch For Lift Trucks. Accident May Cause...	Caution	423
Watch For Low Pipes	Caution	509
Watch For Moving Vehicles	-	547
Watch For Pedestrians	-	577
Watch For Trucks	-	577
Watch Out For Falling Ice	Caution	518
Watch Out For Fork Lift (Floor Sign)	-	497
Watch Out For Fork Lift Trucks	Caution	509
Watch Out For Fork Lift Trucks. Accident...	Caution	423
Watch Out For Fork Truck Operating In Area	Caution	509
Watch Out For Fork Truck Operating In Area...	Caution	423
Watch Out For Forklift Trucks	-	496
Watch Out For Moving Equipment	Danger	514
Watch Out For Moving Equipment Stay Clear	Danger	431
Watch Out For The Other Person	Think	554
Watch Out For Trucks	Caution	570
Watch Out For Trucks. Accident May Cause...	Caution	423
Watch Overhead Clearance	Caution	509
Watch Your Back When Lifting! Use Your...	-	550
Watch Your Fingers And Your Hands...	Caution	509

Sign Legend Index

BradyID.com/s36

Legend Text	Header	Pg
Watch Your Hands And Fingers / Cuidado...	Danger / Peligro	437
Watch Your Head	Caution	509
Watch Your Head	Danger	514
Watch Your Head Low Clearance Could Result...	Caution	423
Watch Your Step	Caution	423
Watch Your Step	Caution	509
Watch Your Step	Caution	533
Watch Your Step	Danger	514
Watch Your Step	Notice	515
Watch Your Step	Safety First	515
Watch Your Step	Warning	516
Watch Your Step	-	479
Watch Your Step	-	496
Watch Your Step	-	517
Watch Your Step (Floor Sign)	-	497
Watch Your Step / Camine Con Cuidado	Caution / Precaucion	434
Watch Your Step / Camine Con Cuidado...	Caution / Precaucion (ANSI)	434
Watch Your Step Use Handrail	Caution	509
Watch Your Step, Falls Can Result In...	Caution	423
Watch Your Step/Fall	-	517
Water Line	Danger	469
Water Shut Off	Notice	486
We Aim For Zero Injuries	-	550
We Are Doing Asbestos We Can	Notice	498
We Are Setting The Standard	-	550
We Cannot Be Responsible For Damage...	Notice	561
Wear Approved Breathing Apparatus Beyond...	Caution	533
Wear Breathing Apparatus In This Area	Caution	533
Wear Ear Protection	Caution	533
Wear Eye Protection	Caution	533
Wear Eye Protection	-	540
Wear Eye Protection When Using Power Tools	Safety First	538
Wear Eye Protection When Using This Machin...	-	540
Wear Face Shield	Caution	533
Wear Face Shield	-	540
Wear Face Shield And Rubber Gloves When...	Danger	431
Wear Face Shield And Rubber Gloves When...	Danger	455
Wear Face Shield Batteries May Explode Tur...	Caution	450
Wear Face Shield When Using Grinder	Safety First	538
Wear Face Shields, Rubber Gloves And Apron...	Safety First	456
Wear Foot Protection	Notice	537
Wear Gloves	-	540
Wear Gloves And Goggles	Caution	533
Wear Goggles	Safety First	432
Wear Goggles	Safety First	538
Wear Goggles And Rubber Gloves...	Danger	455
Wear Goggles And Rubber Gloves...	Warning	457
Wear Goggles Face Shield Rubber Gloves And...	Caution	450
Wear Goggles Or Face Shield	Safety First	538
Wear Goggles Or Face Shield While Operatin...	Caution	533
Wear Goggles Or Face Shield While Operatin...	Caution / Precaucion	435
Wear Goggles Or Use Shield	-	540
Wear Goggles When Chipping Or Grinding	Danger	535
Wear Goggles When Handling Acid Or Caustic	Danger	455
Wear Goggles When Using This Machine	Caution	533
Wear Goggles When Using This Machine	-	540
Wear Goggles When Using This Machine...	Caution	509
Wear Goggles, Face Shield, Rubber Gloves...	Caution	423
Wear Hard Hats	Notice	537
Wear Mask	-	540
Wear Proper Safety Equipment	Think	538
Wear Protective Clothing	Caution	533
Wear Protective Equipment	Caution	533
Wear Protective Equipment In This Area	Warning	538
Wear Protective Safety Equipment When Hand...	Danger	455
Wear Respirator	-	540
Wear Respirator In This Area	Warning (ANSI)	433
Wear Respirator To Protect Your Lungs	Caution (ANSI)	424
Wear Respirator While Spraying	Caution	533
Wear Respirator While Spraying	Danger	535
Wear Safety Equipment	Caution	533
Wear Safety Shoes In This Area	Caution	533
Wear Splash Goggles Face Shield Rubber...	Notice	537
Wear Your Fall Protection	Caution	533
Wear Your Gloves	Warning	538
Wear Your Goggles	-	540
Wear Your Goggles While Operating This...	Danger	535
Wear Your Hair Net	-	540
Wear Your Respirator	Caution	423
Wear Your Respirator	Caution	533
Wear Your Safety Glasses Foresight...	-	540

Legend Text	Header	Pg
Welding Arc Wear Proper Eye Protection	Danger	455
Welding Arc, Wear Proper Eye Protection.	Danger	431
Welding Area	Caution	450
Welding Area	Danger	455
Welding Fumes May Be Present	Caution	450
Welding Fumes May Be Present.	Caution	423
Welding Goggles Must Be Worn At All Times	Danger	535
Welding May Produce Fumes And Gases Hazard...	Caution	450
Wet Floor	Caution	509
Wet Floor, Falls May Result In Injury.	Caution	423
Wet Floors Be Careful	Caution	518
Wet Floors May Result In Injury.	Caution	423
Wheel Chocks Must Be Placed On Both Sides...	Safety First	515
Wheelchair Ramp	-	567
Wheels Must Be Chocked And Engine Turned...	Notice	571
Wheels Must Be Chocked Before Loading...	Notice / Aviso	441
Wheels Must Be Chocked Before Loading...	Safety First	571
When Servicing Or Checking Batteries...	Caution	472
When Throwing Switch Use Left Hand...	Caution	504
Wide Right Turns	Caution	570
Wide Right Turns.	Caution	423
Will Call	-	572
Woman Picto	-	545
Women	-	501
Women	-	545
Women (Braille w/Picto)	-	447
Women (Braille)	-	447
Women / Mujeres	-	443
Women's Health	-	503
Wood Dust Explosion Hazard	Warning	457
Work Area Ahead	-	569
Work Safely Today	-	550
Work Safely You Count	-	550
Worker In Confined Space	Caution	466
Worker In Confined Space	-	468
Would You Like Some Cheese To Along...	-	498
Wrong Way	-	577

X

X-Ray In Use	Caution	541
X-Ray Producing Machine Within	-	543
X-Ray Radiation	Warning	542
Xylene	-	462

Y

Yield	-	577
Yield Pedestrian Crossing	-	572
Yield Pedestrian Crosswalk	-	576
Yield Proceed Slowly	-	572
You Are The Key To Safety	-	550
You Can Obtain A Pair Of Safety Goggles...	Notice	537
You Must Be At Least 18 Years Old To Opera...	Warning	516
Your Habits Are A Reflection Of You.....	-	520
Your Job Is Not Complete Until Your Area...	-	520

Part Number Index

BradyID.com/s36

Catalog #	Pg	Catalog #	Pg	Catalog #	Pg	Catalog #	Pg	Catalog #	Pg	Catalog #	Pg	Catalog #	Pg
20417	352	21778	427	22129	415	22234	418	22357	456	22488	477	22591	532
20418	352	21780	429	22130	415	22236	418	22358	456	22489	477	22592	532
20419	352	21782	427	22131	415	22237	418	22359	456	22490	477	22593	532
20421	352	21783	430	22132	415	22241	418	22360	456	22491	477	22594	532
20422	352	21784	426	22133	415	22246	419	22361	456	22492	477	22595	532
20424	352	21785	426	22134	415	22247	419	22362	456	22493	477	22596	533
20425	352	21788	422	22135	415	22248	419	22363	456	22494	477	22597	533
20426	352	21795	421	22136	415	22249	419	22364	456	22495	488	22599	533
20427	352	21797	421	22137	415	22251	419	22365	456	22496	488	22600	533
20428	352	21798	432	22138	415	22253	564	22366	456	22497	488	22601	533
20429	352	21800	445	22141	415	22254	419	22367	456	22498	491	22602	533
20430	352	21801	421	22142	415	22255	419	22368	456	22499	478	22603	533
20431	352	21803	423	22143	415	22256	419	22369	456	22500	478	22605	534
20432	352	21804	423	22144	415	22257	419	22371	457	22501	478	22606	534
20433	352	21805	432	22145	415	22258	419	22372	457	22502	478	22607	534
20434	352	21806	432	22146	415	22260	419	22373	457	22503	479	22608	534
20435	352	21807	432	22147	415	22261	419	22374	457	22504	479	22609	534
20436	352	21808	432	22148	415	22262	448	22377	457	22505	470	22612	534
20437	352	21810	432	22150	415	22263	448	22378	457	22507	470	22613	534
20438	352	21813	433	22151	416	22266	448	22380	458	22508	470	22614	535
20439	352	21814	433	22152	416	22267	448	22381	458	22509	470	22615	535
20440	352	21815	430	22156	416	22268	448	22385	459	22510	470	22619	535
20441	352	21866	425	22157	416	22269	448	22386	460	22511	470	22620	535
20442	352	21868	428	22158	416	22270	448	22399	530	22512	470	22621	535
20443	352	22052	570	22160	416	22272	448	22400	530	22513	470	22622	536
20444	352	22053	412	22161	416	22273	448	22402	530	22514	470	22623	536
20445	352	22054	412	22162	416	22277	449	22403	530	22515	470	22624	536
20446	352	22059	412	22163	416	22282	449	22404	530	22516	470	22625	536
20447	352	22060	412	22164	416	22283	449	22406	531	22517	507	22626	537
20448	352	22061	412	22166	416	22285	449	22407	531	22518	507	22627	537
20449	352	22062	412	22168	416	22287	449	22408	531	22519	470	22628	537
20450	352	22063	412	22171	416	22289	449	22409	466	22520	470	22629	537
20452	352	22064	412	22172	416	22291	449	22410	466	22521	470	22630	537
20453	352	22065	412	22173	416	22292	450	22411	466	22522	470	22631	537
20454	352	22066	412	22174	416	22293	450	22412	466	22523	470	22632	493
20455	352	22067	412	22175	416	22295	450	22415	532	22524	470	22633	493
20456	352	22069	412	22176	416	22296	450	22416	532	22525	470	22635	493
20457	352	22070	412	22177	416	22297	450	22417	532	22526	470	22636	493
20458	352	22071	413	22178	416	22298	450	22418	532	22527	470	22637	493
20459	352	22072	413	22179	523	22299	450	22419	532	22528	470	22638	493
20460	352	22074	413	22180	523	22300	450	22420	466	22530	470	22639	493
20461	352	22075	413	22181	417	22301	450	22421	466	22532	470	22642	493
20462	352	22076	413	22183	416	22302	450	22424	454	22533	470	22643	493
20463	352	22077	413	22184	416	22304	450	22425	467	22534	470	22644	493
20464	352	22078	413	22185	417	22305	451	22426	467	22535	470	22645	493
20465	352	22079	451	22186	417	22306	451	22429	454	22537	415	22646	493
20466	352	22080	451	22187	417	22308	451	22430	454	22538	415	22647	493
20467	352	22082	413	22188	417	22309	451	22432	467	22541	416	22648	493
20468	352	22083	413	22190	417	22310	451	22433	413	22542	416	22649	493
20469	352	22084	413	22191	417	22311	451	22434	413	22543	470	22650	494
20470	352	22086	413	22192	417	22312	451	22437	468	22544	470	22651	494
20471	352	22087	413	22193	417	22313	451	22438	468	22545	471	22652	494
20472	352	22088	413	22194	417	22314	451	22441	468	22546	471	22653	494
20473	352	22089	413	22195	417	22315	451	22443	542	22549	471	22654	494
20474	352	22090	413	22196	417	22316	451	22445	542	22550	471	22655	494
20475	352	22091	414	22197	417	22317	451	22446	542	22551	471	22656	494
20476	352	22092	414	22198	417	22318	451	22451	544	22552	471	22659	494
20477	352	22093	414	22199	417	22319	451	22453	477	22553	471	22661	494
20478	352	22094	414	22200	417	22320	451	22454	477	22555	471	22662	494
20479	352	22097	414	22201	417	22321	451	22455	477	22558	471	22663	494
20480	352	22098	414	22202	417	22322	451	22456	477	22559	471	22664	494
20481	352	22099	414	22203	417	22323	451	22457	477	22560	479	22665	494
20482	352	22100	414	22204	417	22324	451	22458	477	22561	479	22666	495
20483	352	22101	453	22205	417	22326	454	22459	477	22562	474	22667	495
20484	352	22102	453	22206	417	22327	454	22460	477	22563	474	22668	495
20485	352	22103	414	22207	417	22328	454	22461	489	22564	474	22669	495
20486	352	22104	414	22208	417	22329	454	22462	489	22565	474	22670	495
20487	352	22105	414	22209	417	22330	454	22465	478	22566	474	22671	495
20488	352	22106	414	22210	417	22331	454	22466	478	22567	474	22672	495
20489	352	22109	414	22211	445	22332	454	22467	478	22569	474	22673	495
20490	352	22110	414	22212	445	22333	455	22468	478	22570	474	22678	495
20591	92	22111	414	22213	417	22334	455	22469	478	22575	529	22679	495
20596	92	22112	414	22214	417	22335	455	22470	478	22576	529	22680	495
21335	513	22113	414	22216	417	22336	455	22471	478	22577	529	22681	495
21338	513	22114	414	22217	417	22337	455	22472	478	22578	529	22684	495
21700	432	22115	414	22218	417	22338	455	22473	479	22579	529	22685	495
21703	432	22116	414	22219	417	22339	455	22475	479	22580	529	22686	495
21707	432	22117	415	22220	418	22341	455	22476	479	22581	529	22688	486
21709	422	22118	415	22221	418	22342	455	22479	476	22582	529	22689	486
21713	421	22121	415	22222	418	22343	455	22480	476	22583	529	22690	492
21718	433	22122	415	22224	418	22349	455	22481	476	22584	530	22691	492
21723	425	22123	415	22225	418	22350	455	22482	476	22585	530	22692	492
21725	428	22124	415	22226	418	22351	455	22483	476	22586	530	22693	492
21726	431	22125	415	22228	418	22353	455	22484	476	22587	530	22695	492
21727	426	22126	415	22229	418	22354	455	22485	476	22588	531	22697	448
21728	427	22127	415	22232	418	22355	456	22486	476	22589	531	22698	448
21729	427	22128	415	22233	418	22356	456	22487	477	22590	532	22699	448

Catalog #	Pg	Catalog #	Pg	Catalog #	Pg	Catalog #	Pg	Catalog #	Pg	Catalog #	Pg	Catalog #	Pg
22835	520	22962	510	23065	515	23425	339	23513	339	23608	339	25050	517
22836	520	22963	510	23066	515	23426	339	23514	339	23609	339	25051	517
22839	520	22964	510	23069	515	23427	339	23515	339	23617	339	25052	517
22840	520	22965	511	23070	515	23428	339	23516	339	23618	339	25053	517
22841	520	22966	511	23071	515	23430	339	23517	339	23619	339	25058	517
22842	520	22968	511	23074	515	23431	339	23518	339	23620	339	25060	522
22843	520	22970	511	23077	515	23432	339	23519	339	23621	339	25061	522
22844	520	22971	511	23078	515	23433	339	23520	339	23622	339	25062	522
22845	520	22972	511	23079	515	23434	339	23521	339	23623	339	25063	522
22846	520	22973	511	23090	451	23435	339	23522	339	23624	339	25064	522
22847	520	22974	511	23092	521	23436	339	23523	339	23625	339	25065	522
22849	520	22975	511	23199	334	23437	339	23524	339	23626	339	25068	453
22850	520	22976	511	23200	339	23438	339	23525	339	23630	339	25069	453
22851	520	22977	511	23201	339	23439	339	23526	339	23631	339	25073	522
22852	520	22978	511	23202	339	23440	339	23527	339	23632	339	25076	522
22853	520	22981	511	23203	339	23441	339	23528	339	23633	339	25077	522
22854	520	22982	511	23204	339	23442	339	23529	339	23634	339	25078	522
22855	520	22983	511	23205	339	23443	339	23530	339	23635	339	25079	522
22856	520	22984	511	23206	339	23444	339	23531	339	23636	339	25080	523
22857	520	22985	511	23207	339	23445	339	23532	339	23637	339	25081	523
22858	520	22986	511	23208	339	23446	339	23533	339	23638	339	25082	523
22861	506	22987	511	23209	339	23447	339	23534	339	23639	339	25083	523
22862	506	22989	511	23210	340	23448	339	23535	339	23640	339	25084	523
22863	506	22993	511	23211	340	23449	339	23536	339	23641	339	25085	523
22864	506	22994	511	23212	340	23450	339	23537	339	23642	339	25086	523
22865	506	22995	511	23213	340	23451	339	23538	339	23643	339	25087	523
22867	506	22996	511	23215	486	23452	339	23539	339	23644	339	25088	523
22870	506	22998	511	23216	486	23453	339	23540	339	23645	339	25089	523
22873	506	23000	512	23256	339	23454	339	23541	339	23646	339	25090	523
22874	506	23001	512	23257	339	23455	339	23542	339	23647	339	25091	523
22875	506	23002	512	23258	339	23456	339	23543	339	23648	339	25092	523
22876	506	23003	512	23259	339	23457	339	23544	339	23649	339	25093	523
22877	506	23004	512	23260	339	23458	339	23545	339	23650	339	25094	527
22878	506	23005	512	23261	339	23459	339	23546	339	23651	339	25095	527
22879	506	23006	512	23262	339	23460	339	23547	339	23652	339	25097	523
22880	506	23007	512	23263	339	23461	339	23548	339	23653	339	25098	523
22883	506	23008	512	23264	339	23462	339	23549	339	23654	339	25099	523
22891	506	23009	512	23265	339	23463	339	23550	339	23655	339	25100	523
22892	506	23010	512	23266	339	23464	339	23552	339	23656	339	25101	523
22895	506	23011	512	23267	339	23465	339	23553	339	23657	339	25102	523
22896	506	23012	512	23268	339	23466	339	23554	339	23658	339	25103	523
22897	507	23013	512	23269	339	23467	339	23555	339	23660	339	25104	524
22898	507	23014	512	23270	339	23468	339	23556	339	23661	339	25105	524
22901	507	23015	512	23271	339	23469	339	23557	339	23662	339	25108	527
22902	507	23016	512	23272	339	23470	339	23558	339	23663	339	25109	459
22903	507	23019	512	23273	339	23471	339	23559	339	23664	339	25110	524
22907	507	23020	512	23274	339	23472	339	23560	339	23665	339	25114	524
22909	504	23021	512	23275	339	23473	339	23561	339	23666	339	25115	524
22910	504	23022	512	23276	339	23474	339	23562	339	23667	339	25116	524
22913	507	23023	513	23277	339	23475	339	23563	339	23668	339	25117	524
22914	507	23024	513	23278	339	23476	339	23564	339	23669	339	25118	524
22915	507	23025	513	23279	339	23477	339	23565	339	23670	339	25119	524
22916	507	23026	513	23300	310	23478	339	23566	339	23671	339	25120	524
22917	507	23027	513	23301	341	23479	339	23567	339	23672	339	25121	524
22918	507	23028	513	23302	310	23480	339	23568	339	23673	339	25122	524
22919	507	23029	513	23303	341	23481	339	23569	339	23674	339	25123	525
22920	507	23030	513	23304	341	23482	339	23570	339	23675	339	25124	525
22921	507	23031	513	23305	341	23483	339	23571	339	23676	339	25126	525
22922	507	23032	513	23306	341	23484	339	23572	339	23677	339	25127	525
22923	507	23033	513	23307	341	23485	339	23573	339	23678	339	25130	525
22924	507	23034	513	23308	341	23486	339	23574	339	23679	339	25131	525
22929	508	23035	513	23309	340	23487	339	23575	339	23680	339	25132	523
22930	508	23036	513	23400	339	23488	339	23576	339	23682	339	25133	523
22931	504	23037	513	23401	339	23489	339	23577	339	23683	339	25134	525
22932	504	23038	513	23402	339	23490	339	23578	339	23684	339	25135	525
22933	508	23039	513	23403	339	23491	339	23579	339	23685	339	25136	526
22935	508	23040	513	23404	339	23492	339	23580	339	23686	339	25137	526
22937	509	23041	514	23405	339	23493	339	23581	339	25026	515	25138	456
22939	509	23043	514	23406	339	23494	339	23582	339	25027	515	25139	526
22940	509	23045	514	23407	339	23495	339	23583	339	25028	515	25140	526
22941	509	23046	514	23408	339	23496	339	23584	339	25029	515	25144	526
22942	509	23047	514	23409	339	23497	339	23585	339	25030	515	25145	526
22943	504	23048	514	23410	339	23498	339	23587	339	25031	515	25147	527
22945	510	23049	535	23411	339	23499	339	23588	339	25032	515	25148	527
22946	510	23051	514	23412	339	23500	339	23589	339	25033	515	25149	528
22948	510	23052	514	23413	339	23501	339	23596	339	25034	515	25150	528
22949	510	23054	514	23414	339	23502	339	23597	339	25035	515	25151	528
22950	510	23055	514	23415	339	23503	339	23598	339	25037	515	25152	528
22951	510	23056	514	23416	339	23504	339	23599	339	25038	515	25153	528
22952	510	23057	514	23417	339	23505	339	23600	339	25039	516	25154	528
22953	510	23058	514	23418	339	23506	339	23601	339	25040	516	25155	528
22955	510	23059	514	23419	339	23507	339	23602	339	25041	516	25156	528
22956	510	23060	514	23420	339	23508	339	23603	339	25043	516	25157	458
22957	510	23061	515	23421	339	23509	339	23604	339	25044	516	25161	539
22958	510	23062	515	23422	339	23510	339	23605	339	25045	516	25162	474
22960	510	23063	515	23423	339	23511	339	23606	339	25048	516	25165	458
22961	510	23064	515	23424	339	23512	339	23607	339	25049	516	25166	539

Part Number Index

BradyID.com/s36

Catalog #	Pg	Catalog #	Pg	Catalog #	Pg	Catalog #	Pg	Catalog #	Pg	Catalog #	Pg	Catalog #	Pg
25280	542	25423	453	25547	473	25662	452	25792	570	25922	505	30668	301
25281	542	25424	451	25548	473	25663	452	25795	570	25927	544	30669	460
25282	542	25425	451	25549	473	25665	452	25798	570	25928	544	30670	459
25283	542	25428	452	25551	474	25666	453	25801	570	25929	544	30671	460
25284	542	25429	452	25552	474	25667	453	25804	469	25930	544	30672	460
25285	542	25430	452	25553	474	25668	453	25805	469	25933	544	30673	459
25286	543	25431	452	25556	474	25669	453	25806	571	25934	544	30674	460
25288	543	25436	453	25557	474	25670	453	25807	571	25936	544	30680	334
25289	543	25437	453	25560	474	25671	453	25815	512	25943	544	30681	334
25291	543	25438	453	25562	474	25672	522	25816	512	25944	544	30682	334
25292	543	25439	453	25563	474	25673	522	25819	571	25945	544	30683	334
25295	553	25441	453	25564	474	25674	453	25823	560	25946	544	30684	334
25297	553	25442	453	25565	474	25675	453	25824	561	25947	544	30697	397
25298	553	25443	453	25566	472	25676	486	25825	560	25950	544	30698	397
25299	553	25447	453	25567	472	25677	486	25826	560	25960	446	30699	397
25300	553	25448	454	25569	472	25678	486	25828	571	25961	446	30705	528
25301	553	25449	454	25570	486	25679	486	25829	560	25962	446	30707	528
25302	553	25450	454	25571	537	25680	486	25830	571	25963	446	30911	528
25303	553	25451	454	25574	537	25681	486	25831	561	25964	446	30913	528
25304	553	25453	454	25575	537	25687	518	25832	571	25966	101	30914	528
25307	553	25454	529	25576	537	25688	553	25833	571	25967	101	31218	528
25309	553	25456	529	25577	537	25689	553	25834	571	25968	101	31219	528
25310	553	25457	529	25578	537	25690	486	25835	571	25969	101	31550	301
25311	553	25459	529	25579	537	25691	486	25836	571	25971	446	31551	301
25312	553	25460	530	25581	538	25692	486	25838	561	25972	446	31552	301
25313	553	25461	530	25583	538	25693	486	25839	571	25973	446	31553	301
25314	553	25462	530	25584	538	25696	487	25845	571	25975	446	33341	538
25315	553	25463	530	25585	538	25700	487	25846	560	25977	521	33344	538
25316	553	25464	531	25589	539	25701	487	25847	560	25978	521	33656	531
25317	553	25465	531	25591	539	25702	487	25848	571	26453	417	33658	531
25319	553	25466	531	25592	539	25703	487	25849	571	26521	432	33659	531
25320	553	25467	531	25594	529	25704	487	25851	561	26524	432	33795	538
25323	553	25468	531	25595	529	25705	487	25852	561	26528	432	33796	538
25324	553	25469	531	25596	507	25706	487	25853	562	26530	422	33799	538
25325	553	25470	531	25597	507	25707	487	25854	562	26534	421	34010	399
25326	553	25471	531	25598	508	25708	488	25855	562	26539	433	34110	399
25327	553	25472	531	25599	508	25709	488	25857	572	26543	425	34138	399
25328	553	25473	531	25600	508	25710	488	25858	574	26545	428	34210	399
25329	553	25474	531	25601	508	25711	488	25859	561	26546	431	34238	399
25330	553	25475	531	25604	508	25712	488	25860	560	26547	426	34253	401
25331	553	25476	533	25605	508	25713	489	25861	560	26548	427	34310	399
25332	553	25477	533	25606	508	25714	489	25862	563	26549	427	34340	399
25333	553	25478	534	25607	508	25715	490	25864	572	26553	427	34341	399
25334	553	25479	534	25608	509	25716	490	25865	564	26555	429	34342	399
25335	553	25480	534	25609	509	25717	490	25868	560	26557	427	34353	401
25336	553	25482	534	25610	509	25718	490	25869	572	26558	430	34410	399
25337	553	25484	536	25611	509	25719	489	25870	572	26559	426	34440	399
25338	553	25485	536	25612	509	25720	489	25871	572	26560	426	34441	399
25339	554	25486	536	25613	509	25721	489	25872	572	26563	422	34442	399
25340	554	25487	536	25614	510	25722	489	25874	560	26570	421	35478	553
25341	554	25488	536	25615	510	25723	490	25875	572	26572	421	35480	553
25342	554	25489	536	25618	512	25729	490	25876	505	26573	432	36230	349
25343	554	25490	536	25619	512	25730	491	25877	505	26575	445	36287	358
25344	554	25491	536	25620	512	25734	456	25878	450	26576	421	36288	358
25346	554	25493	536	25621	512	25735	456	25881	471	26578	423	36289	358
25347	554	25494	537	25623	511	25738	457	25883	458	26579	423	36290	358
25348	554	25495	537	25625	513	25739	457	25884	525	26580	432	36301	358
25349	554	25496	537	25626	537	25740	457	25886	446	26582	432	36302	358
25350	554	25498	538	25627	537	25741	457	25889	560	26583	432	36303	358
25351	554	25499	538	25630	515	25742	445	25890	571	26585	432	36304	358
25356	446	25502	472	25631	515	25743	445	25891	530	26586	432	36305	358
25357	446	25503	472	25632	515	25745	458	25892	530	26588	433	36306	358
25360	446	25505	472	25633	515	25746	459	25893	531	26589	433	36307	358
25361	446	25506	472	25634	516	25747	518	25894	531	26590	430	36308	358
25362	446	25512	472	25635	516	25748	518	25895	533	26591	425	36309	358
25364	446	25513	472	25636	516	25751	518	25896	534	26593	428	36310	358
25365	446	25515	472	25637	516	25752	518	25897	473	26641	417	36311	358
25366	446	25516	472	25638	516	25753	518	25898	452	26923	513	36312	358
25368	446	25517	472	25639	516	25754	518	25899	539	28713	397	36313	358
25369	446	25520	472	25640	486	25755	518	25900	473	28714	397	36314	358
25370	446	25521	472	25641	486	25758	518	25901	415	28720	397	36315	358
25371	446	25522	473	25642	486	25759	518	25902	416	29067	494	36316	358
25372	446	25524	473	25643	486	25760	518	25904	494	29069	494	36317	358
25373	446	25526	473	25644	486	25761	475	25906	509	29076	494	36318	358
25374	446	25527	473	25645	486	25762	475	25907	509	29079	494	36319	358
25375	446	25530	473	25646	486	25763	475	25908	533	29081	494	37603	439
25376	446	25531	473	25647	486	25764	475	25909	533	29082	494	37604	439
25377	446	25532	473	25650	452	25765	475	25910	454	29294	496	37606	436
25406	446	25533	473	25651	452	25766	475	25911	512	29296	496	37612	441
25407	446	25534	473	25652	452	25767	476	25912	522	30544	519	37616	442
25413	446	25537	473	25653	452	25768	476	25913	513	30661	301	37617	442
25416	530	25538	473	25654	452	25771	474	25914	490	30662	301	37631	436
25417	530	25539	473	25655	452	25772	474	25917	545	30663	301	37635	436
25418	448	25540	473	25656	452	25773	529	25918	545	30664	301	37636	436
25419	448	25541	473	25657	452	25777	450	25919	545	30665	301	37645	441
25420	451	25545	473	25659	414	25780	445	25920	468	30666	301	37657	442
25422	453	25546	473	25661	452	25781	445	25921	468	30667	301	37660	443
37661	442												
37683	444												
37686	443												
37690	441												
37703	442												
37718	437												
37719	438												
37720	439												
37725	437												
37737	439												
37740	443					</							

Part Number Index

BradyID.com/s36

Catalog #	Pg	Catalog #	Pg	Catalog #	Pg	Catalog #	Pg	Catalog #	Pg	Catalog #	Pg	Catalog #	Pg	Catalog #	Pg
38310	443	38864	439	39698	443	40673	414	40774	417	40886	451	41033	478	41148	530
38313	441	38865	437	39718	441	40674	414	40775	445	40887	451	41034	478	41149	530
38323	444	38866	438	39731	441	40675	414	40776	445	40888	451	41035	478	41150	530
38329	441	38867	439	39738	434	40676	414	40778	417	40889	454	41036	478	41151	530
38338	441	38875	441	39740	441	40677	414	40780	417	40892	454	41037	479	41152	531
38345	434	38877	442	39742	442	40678	414	40781	417	40895	454	41038	479	41153	531
38347	441	38892	437	39756	439	40679	414	40782	556	40896	454	41043	476	41154	532
38349	442	38893	438	39758	438	40680	414	40785	418	40897	455	41044	476	41155	532
38359	439	38902	441	39769	442	40681	415	40786	418	40898	455	41045	476	41156	532
38360	437	38904	442	39780	437	40682	415	40788	418	40899	455	41046	476	41157	532
38361	438	38914	439	39789	442	40685	415	40789	418	40900	455	41047	476	41158	532
38362	439	38920	437	39803	439	40686	415	40790	418	40901	455	41048	476	41159	532
38368	441	38928	439	39804	437	40687	415	40791	418	40902	455	41049	476	41160	533
38370	442	38931	443	39811	437	40688	415	40792	418	40904	455	41050	476	41161	533
38383	437	38933	443	39817	439	40689	415	40793	418	40905	455	41051	477	41162	533
38384	438	38937	440	39820	443	40690	415	40795	418	40906	455	41052	477	41163	533
38392	442	38942	434	39821	443	40691	415	40796	418	40908	455	41053	477	41164	533
38403	437	38955	443	39833	437	40692	415	40797	418	40913	455	41054	477	41165	533
38404	438	38964	434	39850	434	40694	415	40798	418	40914	455	41055	477	41166	533
38411	437	38973	439	39860	439	40695	415	40799	418	40920	456	41058	477	41167	533
38417	439	38976	443	39876	439	40696	415	40800	418	40922	456	41059	488	41170	534
38420	443	38979	440	39880	443	40698	415	40801	418	40923	456	41060	488	41171	534
38425	440	38984	434	39881	443	40699	415	40803	418	40924	456	41061	488	41172	534
38430	434	38990	439	39883	443	40700	415	40805	418	40925	456	41062	491	41173	534
38440	439	38993	442	39894	439	40702	415	40806	418	40926	456	41063	478	41176	534
38444	443	38994	443	39912	439	40703	415	40807	418	40927	456	41064	478	41177	534
38457	437	38995	443	39951	438	40704	415	40808	418	40928	456	41065	478	41178	535
38463	439	38996	442	39954	439	40705	415	40809	418	40933	456	41066	478	41184	535
38474	434	38997	443	39961	440	40706	415	40810	419	40934	456	41067	479	41186	536
38478	439	39008	439	39964	435	40707	415	40811	419	40935	457	41068	479	41187	536
38481	442	39012	443	39965	435	40708	415	40812	419	40936	457	41069	470	41188	536
38482	443	39026	439	39967	436	40709	415	40813	419	40937	457	41070	470	41190	537
38483	443	39029	442	39978	437	40710	415	40815	419	40938	457	41071	470	41191	537
38484	442	39054	441	39981	439	40711	415	40816	564	40942	457	41073	470	41192	537
38485	443	39055	441	39991	435	40712	415	40817	564	40943	457	41074	470	41193	537
38514	439	39071	438	40194	417	40713	415	40818	419	40949	459	41075	470	41194	537
38571	438	39074	439	40616	570	40714	415	40819	419	40953	466	41076	470	41195	537
38574	439	39081	440	40617	412	40715	416	40820	419	40954	466	41077	470	41197	493
38581	440	39084	435	40618	412	40716	416	40821	419	40964	530	41078	470	41198	493
38585	435	39085	435	40621	412	40717	416	40825	419	40965	530	41079	470	41200	493
38586	435	39086	435	40622	412	40718	416	40826	448	40966	530	41080	470	41201	493
38587	436	39087	436	40623	412	40720	416	40827	448	40967	530	41081	507	41202	493
38603	438	39108	437	40624	412	40721	416	40829	448	40968	530	41082	507	41203	493
38604	439	39111	439	40625	412	40722	416	40831	448	40970	531	41083	508	41206	493
38605	436	39121	435	40626	412	40723	416	40832	448	40971	531	41084	470	41207	493
38606	436	39123	435	40627	412	40724	416	40833	448	40972	531	41085	470	41208	493
38612	441	39124	437	40628	412	40725	416	40834	448	40973	466	41086	470	41209	493
38614	441	39135	437	40629	412	40726	416	40836	448	40974	466	41087	470	41210	493
38616	442	39138	439	40630	412	40728	416	40837	448	40975	466	41088	470	41211	493
38617	442	39145	440	40631	412	40729	416	40840	449	40980	532	41090	470	41213	493
38628	439	39148	435	40632	412	40730	416	40841	449	40981	532	41093	470	41214	494
38629	439	39149	435	40633	412	40732	416	40846	449	40982	532	41094	470	41215	494
38630	436	39150	435	40635	413	40734	416	40847	449	40983	532	41095	470	41217	494
38637	441	39151	437	40636	413	40736	416	40848	449	40984	466	41096	470	41218	494
38640	442	39161	439	40637	413	40737	416	40849	449	40987	466	41097	470	41219	494
38641	442	39171	435	40638	413	40739	416	40850	449	40988	454	41098	470	41220	494
38653	439	39173	435	40639	413	40740	416	40851	449	40989	467	41099	470	41221	494
38654	439	39480	197	40640	413	40741	416	40852	449	40990	467	41100	470	41223	494
38655	436	39481	197	40641	413	40742	416	40853	449	40991	467	41101	415	41225	494
38656	436	39503	438	40642	413	40744	523	40856	450	40992	467	41102	415	41226	494
38662	441	39504	439	40643	451	40746	417	40857	450	40993	467	41106	416	41227	494
38665	442	39505	436	40644	451	40747	416	40858	450	40994	467	41107	470	41229	494
38666	442	39506	436	40645	413	40748	416	40859	450	40995	467	41108	470	41230	495
38676	437	39512	441	40646	413	40749	417	40860	450	40996	467	41109	471	41231	495
38679	436	39514	441	40647	413	40750	417	40861	450	40997	413	41110	471	41232	495
38683	436	39517	442	40648	475	40751	417	40862	450	40998	413	41113	471	41233	495
38684	436	39528	439	40649	413	40752	417	40863	450	40999	468	41116	471	41236	495
38706	436	39529	439	40650	413	40753	417	40864	450	41001	468	41117	471	41237	495
38711	436	39531	436	40651	534	40754	417	40865	450	41002	468	41123	471	41243	495
38730	436	39537	441	40652	534	40755	417	40866	450	41003	468	41124	479	41244	495
38734	436	39542	442	40654	413	40756	417	40867	450	41006	468	41125	479	41245	495
38742	441	39553	439	40655	414	40757	417	40868	450	41007	542	41126	474	41248	495
38756	442	39554	439	40656	414	40758	417	40869	451	41008	542	41127	474	41249	495
38767	437	39555	436	40657	414	40759	417	40870	451	41017	477	41128	474	41250	495
38775	442	39556	436	40658	414	40760	417	40871	451	41018	477	41129	474	41252	495
38797	444	39567	442	40661	414	40761	417	40873	451	41019	477	41130	474	41253	495
38799	443	39576	437	40662	414	40762	417	40874	451	41020	477	41131	474	41254	492
38800	443	39579	436	40663	414	40763	417	40876	451	41021	477	41133	474	41255	492
38803	441	39590	436	40664	414	40764	417	40877	451	41022	477	41134	474	41256	492
38813	444	39601	436	40665	453	40765	417	40878	451	41023	477	41136	474	41257	492
38816	443	39605	436	40666	453	40766	417	40879	451	41024	477	41137	474	41260	492
38819	441	39606	436	40667	414	40767	417	40880	451	41025	489	41141	529	41261	448
38831	444	396													

Part Number Index

BradyID.com/s36

Catalog #	Pg	Catalog #	Pg	Catalog #	Pg	Catalog #	Pg	Catalog #	Pg	Catalog #	Pg	Catalog #	Pg
43079	472	43198	512	43319	445	43461	525	44157	386	44720	339	45053	432
43080	472	43200	511	43320	445	43462	446	44158	386	44721	339	45054	432
43081	472	43202	513	43322	458	43464	571	44159	386	44722	339	45055	430
43082	472	43203	537	43323	459	43465	573	44160	386	44723	339	45056	430
43083	472	43204	537	43324	518	43466	560	44201	386	44724	339	45057	421
43084	472	43208	515	43325	518	43467	571	44202	386	44725	339	45058	421
43089	472	43209	515	43328	518	43468	530	44204	386	44726	339	45059	428
43090	472	43210	515	43329	518	43469	530	44206	386	44727	339	45060	428
43092	472	43211	516	43331	518	43470	531	44207	386	44728	339	45063	433
43094	472	43212	516	43332	518	43471	531	44208	386	44729	339	45064	433
43095	472	43213	516	43333	518	43472	533	44210	386	44730	339	45065	433
43096	472	43214	516	43336	518	43473	534	44211	386	44732	339	45067	432
43097	472	43215	516	43337	518	43474	473	44212	386	44733	339	45068	432
43098	472	43216	516	43338	475	43475	452	44213	386	44734	339	45069	432
43099	473	43217	486	43339	475	43476	539	44214	386	44735	339	45071	421
43101	473	43218	486	43340	475	43477	473	44215	386	44736	339	45072	421
43102	473	43220	486	43341	475	43478	415	44216	386	44737	339	45073	432
43104	473	43221	486	43342	475	43479	416	44218	386	44738	339	45074	432
43107	473	43222	486	43343	475	43481	494	44221	386	44739	339	45075	421
43108	473	43223	486	43344	476	43483	509	44222	386	44740	339	45076	421
43109	473	43224	486	43345	476	43484	509	44227	386	44741	339	45077	433
43110	473	43228	452	43349	474	43485	533	44229	386	44742	339	45078	433
43111	473	43230	452	43350	529	43486	533	44231	386	44743	339	45080	428
43112	473	43231	452	43352	519	43487	454	44232	386	44744	339	45081	433
43113	473	43232	452	43353	450	43488	512	44233	386	44745	339	45082	433
43114	473	43233	452	43354	450	43489	522	44234	386	44746	339	45084	425
43115	473	43236	414	43355	490	43490	513	44238	386	44747	339	45085	432
43116	473	43237	452	43356	418	43491	490	44242	386	44748	339	45086	432
43117	473	43238	452	43357	445	43493	545	44247	386	44749	339	45087	427
43118	473	43239	452	43358	445	43494	545	44248	386	44750	339	45088	427
43119	473	43240	452	43363	473	43495	545	44250	386	44751	339	45089	431
43120	473	43241	452	43364	473	43496	448	44255	386	44752	339	45090	431
43122	473	43242	452	43369	570	43497	511	44256	386	44753	339	45091	424
43123	473	43243	453	43372	570	43499	450	44257	386	44755	339	45092	424
43124	473	43244	453	43375	570	43500	507	44258	386	44756	339	45093	423
43125	473	43245	453	43378	570	43502	460	44259	386	44757	339	45094	423
43127	474	43246	453	43381	469	43504	523	44260	386	44758	339	45095	433
43128	474	43247	453	43382	469	43505	454	44301	386	44759	339	45096	433
43129	474	43248	453	43383	571	43507	452	44302	386	44979	432	45097	423
43130	474	43249	522	43384	571	43508	453	44304	386	44980	432	45099	422
43134	474	43250	522	43392	512	43510	454	44306	386	44981	425	45100	422
43139	474	43251	453	43396	571	43511	494	44307	386	44982	425	45102	420
43140	474	43254	486	43400	560	43514	448	44308	386	44983	431	45103	432
43141	474	43255	486	43401	561	43517	468	44310	386	44984	431	45104	432
43142	474	43256	486	43402	560	43518	468	44311	386	44985	432	45105	432
43143	472	43257	486	43403	560	43519	505	44313	386	44989	421	45106	432
43144	472	43258	486	43405	571	43747	468	44314	386	44990	421	45107	421
43145	472	43265	553	43406	560	43748	468	44315	386	44992	428	45108	421
43146	472	43267	486	43407	571	43753	468	44327	386	44993	429	45109	423
43147	537	43268	486	43408	561	43754	468	44328	386	44994	429	45110	423
43148	537	43269	486	43409	571	43758	468	44329	386	44995	433	45111	432
43151	537	43272	487	43410	571	43759	468	44331	386	44996	433	45112	432
43152	537	43274	487	43411	571	43760	468	44332	386	44999	432	45113	432
43153	537	43277	487	43412	571	43906	521	44333	386	45000	432	45115	432
43154	537	43278	487	43413	571	43979	460	44338	386	45001	432	45116	432
43155	537	43279	487	43415	561	43983	460	44342	386	45004	421	45117	425
43156	537	43281	487	43416	571	44099	386	44347	386	45008	421	45118	425
43157	538	43282	487	43421	560	44100	386	44359	386	45009	433	45119	431
43158	538	43283	487	43422	571	44101	386	44360	386	45011	428	45121	432
43159	538	43284	487	43423	560	44102	386	44400	340	45012	428	45122	432
43160	538	43285	488	43424	560	44104	386	44401	340	45013	433	45123	429
43161	538	43286	488	43425	571	44106	386	44402	340	45015	425	45124	429
43162	538	43287	488	43426	571	44107	386	44403	340	45017	432	45125	421
43168	539	43288	488	43427	561	44108	386	44500	387	45018	432	45126	421
43171	529	43289	488	43428	561	44110	386	44501	387	45019	427	45127	428
43172	529	43290	489	43429	561	44111	386	44503	387	45020	427	45129	429
43173	507	43291	489	43430	562	44112	386	44545	522	45021	431	45131	433
43174	507	43292	490	43431	562	44113	386	44607	545	45022	431	45132	433
43175	508	43293	490	43432	562	44114	386	44608	545	45023	424	45133	433
43176	508	43294	490	43434	572	44115	386	44702	339	45024	424	45136	432
43177	508	43295	490	43435	574	44116	386	44703	339	45025	423	45138	432
43178	508	43297	489	43436	561	44118	386	44704	339	45026	423	45139	421
43181	508	43298	489	43437	560	44121	386	44705	339	45028	433	45140	421
43182	508	43299	489	43438	560	44122	386	44706	339	45029	423	45141	432
43183	508	43300	490	43439	563	44124	386	44707	339	45031	422	45143	421
43184	508	43302	491	43440	575	44125	386	44708	339	45032	422	45144	421
43185	509	43303	491	43442	564	44126	386	44709	339	45033	420	45145	433
43186	509	43304	491	43445	560	44127	386	44710	339	45035	432	45146	433
43187	509	43305	490	43447	572	44129	386	44711	339	45039	421	45147	428
43188	509	43306	490	43448	572	44131	386	44712	339	45040	421	45148	428
43189	509	43307	491	43449	572	44132	386	44713	339	45041	423	45150	433
43190	509	43311	456	43450	564	44133	386	44714	339	45042	423	45151	425
43191	510	43312	456	43451	560	44134	386	44715	339	45045	432	45153	432
43192	510	43315	457	43452	572	44138	386	44716	339	45047	432	45154	432
43195	512	43316	457	43454	505	44149	386	44717	339	45048	432	45155	427
43196	512	43317	457	43455	450	44151	386	44718	339	45050	425	45156	427
43197	512	43318	457	43458	471	44155	386	44719	339	45052	431	45157	431

Part Number Index

BradyID.com/s36

Catalog #	Pg	Catalog #	Pg	Catalog #	Pg	Catalog #	Pg	Catalog #	Pg	Catalog #	Pg	Catalog #	Pg
46664	432	47198	468	48853	462	49021	420	50016	401	50995	244	52210	400
46670	422	47203	523	48854	462	49024	432	50017	401	50996	244	52211	400
46674	421	47204	468	48855	462	49026	432	50018	401	50997	244	52212	400
46679	433	47206	450	48856	462	49027	421	50019	401	50998	455	52213	400
46687	428	47239	308	48857	462	49029	423	50020	401	51171	199	52214	400
46688	431	47243	308	48858	462	49030	423	50053	374	51172	241	52215	400
46689	426	47247	489	48859	462	49032	432	50054	374	51173	241	52216	400
46690	427	47251	308	48860	462	49035	498	50055	374	51181	246	52217	400
46691	427	47273	487	48861	462	49041	499	50056	374	51186	246	52219	400
46731	427	47279	490	48862	462	49042	501	50198	203	51187	247	52220	400
46732	428	47288	477	48863	462	49043	501	50199	203	51188	247	52641	351
46733	429	47305	536	48864	462	49044	499	50248	323	51189	247	52642	351
46735	427	47307	537	48865	462	49045	501	50250	203	51194	247	52643	351
46736	430	47327	415	48866	462	49057	496	50258	203	51195	247	52644	351
46737	426	47329	560	48867	462	49058	496	50261	203	51196	247	52665	351
46738	426	47330	416	48868	462	49060	496	50269	504	51252	220	52673	351
46741	422	47332	536	48869	462	49061	496	50270	437	51254	220	52674	351
46748	421	47333	537	48870	462	49062	496	50274	195	51256	220	53202	551
46750	421	47334	537	48871	462	49063	496	50275	323	51258	220	53203	551
46751	432	47337	519	48872	462	49064	496	50280	196	51260	220	55260	358
46753	445	47375	537	48873	462	49065	496	50281	196	51264	221	55261	358
46754	421	47437	496	48874	462	49066	496	50282	323	51265	221	55262	358
46756	423	47518	519	48875	462	49067	496	50283	196	51279	194	55263	358
46757	423	47526	519	48876	462	49068	496	50286	323	51280	194	55290	300
46758	432	47532	519	48877	462	49069	468	50287	323	51281	194	55291	300
46759	432	47533	519	48878	462	49070	468	50289	196	51282	194	55292	300
46760	432	47538	545	48879	462	49111	554	50290	323	51283	194	55293	300
46761	432	47540	545	48880	462	49112	554	50291	323	51284	194	55294	300
46763	432	47546	545	48881	462	49113	554	50292	196	51290	194	55295	300
46764	432	47550	519	48882	462	49114	554	50293	196	51291	194	55296	300
46766	433	47551	545	48883	462	49115	554	50684	499	51292	194	55297	300
46767	433	47555	545	48884	462	49116	554	50685	500	51297	194	55300	300
46768	430	47579	528	48885	462	49117	554	50687	499	51298	194	55301	300
46819	425	47587	528	48886	462	49227	323	50688	499	51299	194	55302	300
46821	428	47593	528	48887	462	49228	323	50691	500	51339	192	55303	300
46872	527	47595	528	48888	462	49234	323	50692	500	51344	192	55312	300
46979	573	47606	528	48889	462	49550	396	50693	500	51345	192	55313	300
46990	527	47612	528	48890	462	49551	396	50695	500	51346	192	55314	300
46993	525	47618	519	48891	462	49552	396	50696	500	51347	192	55358	301
47000	446	47632	528	48892	462	49553	396	50697	500	51353	192	55359	301
47002	446	47636	528	48893	462	49554	396	50698	500	51360	195	55364	358
47004	446	47638	528	48894	462	49555	396	50777	499	51361	195	55365	358
47005	473	47639	528	48895	462	49556	396	50783	499	51362	195	55368	358
47006	414	47643	443	48896	462	49557	396	50784	500	51363	195	55371	358
47008	414	47645	443	48897	462	49558	396	50785	499	51368	195	55775	580
47010	522	47646	443	48898	462	49559	396	50786	499	51369	195	55784	580
47014	446	47649	528	48899	462	49560	396	50899	213	51370	195	56681	580
47018	531	47651	528	48966	432	49561	396	50900	550	51371	195	56687	580
47022	512	47652	528	48967	432	49562	396	50901	550	51376	195	56688	580
47024	453	47655	443	48968	432	49563	396	50902	550	51377	195	56691	519
47034	477	47657	443	48972	431	49564	396	50903	550	51378	195	56694	580
47035	477	47658	443	48974	432	49565	396	50904	548	51379	195	56699	569
47039	490	47668	545	48975	429	49566	396	50905	548	51388	213	56726	569
47040	477	47670	545	48976	429	49567	396	50906	548	51390	213	56727	569
47050	530	47671	545	48977	421	49568	396	50907	549	51392	213	56750	569
47056	529	47674	545	48978	421	49569	396	50908	548	51394	213	56767	569
47058	506	47676	545	48979	428	49570	396	50909	549	51395	213	56789	569
47059	529	47677	545	48980	428	49571	396	50910	548	51442	208	56791	569
47060	506	47685	545	48983	433	49572	396	50911	550	51447	99	56795	569
47061	530	47690	545	48984	433	49573	396	50912	550	51448	83	56798	569
47064	531	47691	545	48987	432	49574	396	50914	315	51545	487	56799	569
47075	470	47699	545	48988	432	49576	396	50924	213	51546	488	56800	569
47093	412	47701	545	48989	432	49577	396	50932	213	51547	492	56818	569
47094	529	47708	545	48990	432	49578	396	50937	200	51549	492	56897	569
47100	530	47713	545	48991	421	49579	396	50938	200	51550	492	56905	477
47101	531	47721	545	48992	421	49580	396	50939	200	51551	477	56907	477
47113	470	47722	545	48995	421	49581	396	50940	208	51552	477	56908	477
47115	518	47725	545	48996	421	49801	496	50941	209	51553	524	56926	334
47116	519	47727	545	48998	433	49805	496	50943	209	51554	524	56927	334
47117	448	47728	545	48999	428	49806	496	50944	209	51555	489	56928	334
47124	508	47731	545	49001	433	49807	496	50945	209	51556	489	56929	334
47146	473	47733	545	49003	425	49900	340	50947	213	51584	82	56930	334
47148	453	47734	545	49004	425	49901	340	50948	209	51585	82	56931	334
47152	414	48111	320	49005	432	49902	340	50950	213	51586	82	56932	334
47158	534	48112	320	49006	432	49903	340	50951	209	52042	91	56933	334
47159	513	48840	462	49008	427	49904	340	50953	213	52044	91	56934	334
47160	513	48841	462	49009	431	49905	340	50954	209	52045	91	56935	334
47161	514	48842	462	49010	431	49906	340	50956	213	52047	91	56936	334
47162	514	48843	462	49011	424	49907	340	50961	184	52059	91	56937	334
47169	474	48845	462	49013	423	49908	340	50962	184	52148	90	56938	334
47170	474	48846	462	49014	423	49909	340	50979	241	52149	90	56939	334
47171	522	48847	462	49015	433	50010	401	50989	247	52150	90	56940	334
47172	525	48848	462	49016	433	50011	401	50990	247	52152	90	56941	184
47189	534	48849	462	49017	423	50012	401	50991	247	52203	400	56942	184
47192	513	48850	462	49018	423	50013	401	50992	247	52204	400	56944	184
47195	473	48851	462	49019	422	50014	401	50993	244	52207	400	56945	184
47196	468	48852	462	49020	422	50015	401	50994	244	52208	400	56946	184

Part Number Index

BradyID.com/s36

Catalog #	Pg	Catalog #	Pg	Catalog #	Pg	Catalog #	Pg	Catalog #	Pg	Catalog #	Pg	Catalog #	Pg	Catalog #	Pg
57985	345	59114	485	60173	504	60265	394	60413	464	63203	570	63395	463	65269	229
57986	345	59122	485	60174	504	60266	394	60414	464	63204	570	63396	463	65270	323
57987	345	59277	485	60175	504	60267	394	60416	464	63207	571	63399	463	65273	379
57988	345	59279	475	60176	504	60268	394	60419	464	63208	570	63400	463	65279	224
57989	345	59283	485	60177	505	60269	394	60421	464	63210	571	63403	463	65280	379
57990	345	59287	485	60178	504	60270	394	60423	464	63212	464	63404	463	65289	234
57991	345	59288	485	60179	505	60271	394	60425	464	63214	465	63406	464	65291	233
57992	345	59289	485	60180	505	60272	394	60426	464	63240	375	63407	464	65299	323
57993	345	59293	485	60181	386	60273	394	60427	464	63300	463	63409	464	65318	208
57994	345	59298	485	60182	386	60274	394	60428	464	63301	463	63410	464	65319	208
57995	345	59299	485	60183	386	60275	394	60431	464	63302	463	63411	464	65320	208
57996	345	59301	485	60184	386	60276	394	60433	464	63303	463	63412	464	65321	221
57997	345	59303	485	60185	386	60277	394	60434	464	63304	463	63414	464	65329	221
57998	345	59305	485	60186	386	60278	394	60435	464	63306	463	63415	464	65347	328
57999	345	59307	485	60187	386	60279	394	60436	464	63307	463	63418	464	65348	328
58000	345	59329	477	60188	386	60280	394	60445	375	63308	463	63419	464	65349	328
58001	345	59330	477	60189	386	60281	394	60447	375	63310	463	63420	464	65350	328
58002	345	59335	485	60190	386	60282	394	60499	501	63311	463	63421	464	65371	324
58003	345	59336	485	60191	386	60283	394	60504	458	63312	463	63422	464	65372	328
58004	345	59341	485	60192	386	60284	394	60506	466	63313	463	63423	464	65373	328
58005	345	59342	485	60193	386	60285	394	60507	469	63314	463	63425	464	65375	197
58006	345	59345	485	60194	386	60286	394	60508	463	63316	463	63426	464	65376	197
58007	345	59349	485	60195	386	60287	394	60509	513	63317	463	63428	464	65387	221
58008	345	59369	537	60196	386	60288	394	60510	415	63318	463	63429	464	65392	227
58009	345	59379	474	60197	386	60289	394	60511	536	63320	463	63431	464	65396	221
58010	345	59380	474	60198	386	60290	394	60533	458	63321	463	63433	464	65397	221
58011	345	59381	474	60199	386	60291	394	60535	466	63322	463	63434	464	65402	213
58012	345	59382	473	60200	386	60292	394	60536	469	63323	463	63436	464	65403	213
58013	345	59383	473	60201	386	60293	394	60537	513	63324	463	63437	464	65404	221
58014	345	59384	473	60202	386	60294	394	60538	513	63325	463	63438	464	65405	233
58015	345	59385	473	60203	386	60295	394	60539	415	63326	463	63439	464	65406	221
58016	345	59386	473	60204	386	60296	394	60540	536	63327	463	63441	464	65407	203
58017	345	59387	473	60205	386	60297	394	60563	458	63328	463	63442	464	65408	203
58200	300	59388	479	60206	386	60298	394	60568	459	63331	463	63443	464	65440	203
58201	300	59389	479	60207	386	60299	394	60569	466	63332	463	63444	464	65441	203
58202	300	59391	479	60208	386	60300	394	60570	469	63333	463	63446	464	65442	203
58203	300	59395	455	60209	386	60301	394	60571	469	63334	463	63447	464	65443	203
58220	300	59397	455	60210	386	60302	394	60572	426	63336	463	63448	464	65444	203
58221	300	59404	458	60211	386	60303	394	60573	539	63337	463	63449	464	65445	203
58222	300	59506	513	60212	386	60304	394	60574	427	63339	463	63452	464	65446	203
58223	300	59507	513	60213	386	60305	394	60575	513	63340	463	63454	464	65447	203
58250	300	59508	513	60214	386	60306	394	60576	513	63341	463	63455	464	65448	203
58251	300	59529	78	60215	386	60307	393	60578	415	63342	463	63473	376	65450	203
58252	300	59530	78	60216	386	60308	393	60579	536	63344	463	64057	211	65451	203
58253	300	59531	78	60217	386	60309	393	60580	473	63345	463	64221	225	65452	203
58255	302	59532	78	60218	386	60310	393	62423	433	63346	463	64331	101	65453	203
58257	302	59918	359	60219	386	60311	393	62433	431	63347	463	64332	101	65454	203
58268	374	59919	345	60220	386	60312	393	62436	427	63348	463	64333	101	65455	203
58272	374	59920	345	60221	386	60313	393	62530	429	63349	463	64335	101	65456	323
58273	374	59921	345	60222	386	60314	393	62538	422	63350	463	64336	101	65457	323
58274	374	59922	345	60223	386	60315	393	62545	421	63351	463	64339	101	65500	205
58300	374	59923	345	60224	386	60332	374	62550	445	63352	463	64340	101	65501	333
58301	374	59924	345	60225	386	60333	374	62551	421	63353	463	64347	101	65502	203
58342	305	59925	345	60226	386	60348	458	62555	432	63354	463	64348	101	65503	203
58343	305	59926	345	60227	386	60349	458	62557	432	63355	463	64349	101	65504	203
58344	305	59927	345	60228	386	60350	460	62560	432	63356	463	64355	101	65505	203
58345	305	59928	345	60229	386	60362	375	62561	432	63357	463	64356	101	65506	203
58346	305	59929	345	60230	386	60363	375	62734	422	63358	463	64357	101	65508	190
58347	305	59930	345	60231	386	60364	375	62738	421	63359	463	64401	101	65511	505
58348	305	59931	345	60232	386	60365	375	62743	433	63360	463	64402	101	65515	203
58349	305	59932	345	60233	386	60366	375	62753	428	63361	463	64403	101	65516	504
58351	305	59933	345	60234	386	60367	375	62754	431	63362	463	64404	101	65520	203
58352	305	59934	345	60235	386	60369	375	62756	427	63363	463	64405	101	65521	203
58353	305	59935	345	60237	386	60372	390	62791	428	63364	463	64539	225	65522	203
58354	305	59936	345	60241	468	60373	390	62792	429	63365	463	64540	225	65523	203
58388	305	59937	345	60243	395	60375	464	62794	427	63366	463	64731	101	65524	203
58389	305	59938	345	60244	395	60376	464	62796	426	63368	463	64732	101	65525	203
58413	309	59939	345	60245	395	60377	464	62797	426	63369	463	64733	101	65526	203
58476	93	59940	345	60246	395	60380	464	62807	421	63371	463	64735	101	65527	203
58500	374	59941	345	60247	395	60382	464	62809	421	63372	463	64736	101	65534	203
58501	374	59942	345	60248	395	60383	464	62810	432	63373	463	64737	101	65535	203
58502	374	59943	345	60249	395	60384	464	62812	445	63375	463	64739	101	65560	211
58503	374	59944	345	60250	395	60387	464	62813	421	63376	463	64740	101	65561	211
58504	374	59946	359	60251	395	60388	464	62816	423	63377	463	64741	101	65562	211
58510	374	59955	465	60252	395	60390	464	62817	432	63378	463	64984	93	65563	211
58511	374	59956	465	60253	395	60391	464	62818	432	63380	463	64985	93	65564	211
58515	374	59980	345	60254	395	60394	464	62822	432	63381	463	65039	530	65570	504
58621	461	59981	345	60255	395	60398	464	62827	430	63383	463	65040	199	65571	504
58656	374	59982	345	60256	395	60400	464	62866	425	63384	463	65043	231	65575	504
58706	93	60141	465	60257	395	60402	464	62868	428	63385	463	65159	446	65576	504
58763	448	60142	465	60258	395	60403	464	62950	541	63386	463	65240	201	65585	211
58764	448	60143	465	60259	395	60404									

Part Number Index

BradyID.com/s36

Catalog #	Pg	Catalog #	Pg	Catalog #	Pg	Catalog #	Pg	Catalog #	Pg	Catalog #	Pg	Catalog #	Pg	Catalog #	Pg
65592	211	67992	541	69277	566	69581	538	70246	451	70460	478	71136	418	72412	304
65593	211	69000	453	69282	519	69582	486	70247	560	70462	553	71142	418	72428	451
65594	211	69005	449	69290	448	69583	486	70248	454	70466	470	71166	475	72473	453
65595	211	69006	539	69291	448	69584	538	70249	454	70467	513	71178	562	72489	453
65596	211	69008	520	69292	472	69585	457	70250	467	70468	513	71199	418	72503	454
65597	211	69012	518	69294	454	69586	474	70252	467	70470	507	71216	418	72537	454
65598	211	69013	518	69301	561	69587	474	70255	469	70475	532	71229	417	72546	456
65599	211	69023	473	69302	471	69588	515	70256	448	70479	415	71258	417	72573	449
65645	225	69024	473	69304	454	69590	515	70257	560	70495	537	71282	419	72587	455
65666	212	69025	474	69307	518	69591	417	70258	451	70503	572	71288	419	72605	553
65669	212	69026	473	69308	454	69594	515	70260	451	70506	532	71293	419	72623	519
65670	203	69028	511	69315	472	69595	515	70267	452	70507	537	71313	419	72655	520
65671	203	69031	507	69317	511	69596	515	70270	456	70508	545	71326	419	72700	494
65672	199	69032	418	69331	531	69599	523	70273	534	70509	523	71335	416	72708	494
65673	229	69035	474	69333	553	69600	524	70278	506	70515	535	71366	479	72722	494
65674	228	69036	473	69337	454	69601	523	70279	536	70517	535	71373	479	72752	520
65675	228	69041	529	69339	474	69603	417	70280	506	70518	554	71389	417	72800	520
65682	505	69044	519	69344	512	69604	457	70286	529	70522	416	71396	419	72808	519
65688	221	69046	510	69350	514	69606	417	70287	534	70523	537	71425	472	72883	495
65690	224	69050	561	69352	553	69607	471	70288	529	70525	478	71432	472	72897	495
65691	224	69054	451	69364	519	69608	516	70290	511	70526	572	71463	474	72936	553
65692	212	69057	472	69371	448	69609	516	70293	553	70527	508	71473	474	72949	520
65693	212	69068	506	69380	415	69611	516	70298	534	70528	508	71479	474	72975	518
65695	229	69070	451	69382	415	69612	417	70299	529	70529	508	71543	414	72988	528
65696	227	69071	488	69387	415	69613	474	70302	530	70532	470	71545	414	73009	510
65699	199	69074	490	69399	455	69614	516	70303	530	70533	472	71565	473	73052	510
65750	224	69075	510	69404	507	69615	457	70305	530	70534	472	71570	473	73058	510
65751	224	69080	516	69405	418	69755	553	70306	473	70536	568	71572	473	73086	510
65777	234	69087	518	69407	456	69763	504	70315	516	70537	568	71580	414	73400	447
65780	241	69088	493	69408	449	69765	450	70317	458	70542	470	71643	489	73403	447
65810	220	69089	452	69409	455	69767	445	70322	506	70546	515	71649	489	73404	472
65814	220	69090	506	69410	415	69768	445	70323	477	70547	513	71655	490	73405	571
65815	220	69091	470	69413	513	69771	413	70325	477	70548	470	71688	490	73408	454
65817	468	69096	417	69414	553	69775	448	70327	452	70550	479	71708	486	73410	539
65825	446	69097	413	69415	471	69783	518	70329	452	70555	553	71715	486	73412	453
65828	446	69099	417	69416	517	69785	554	70330	414	70559	449	71732	491	73414	470
65903	379	69100	570	69417	513	69789	445	70335	530	70562	572	71779	492	73415	512
65909	467	69101	413	69425	518	69791	516	70336	537	70563	509	71895	452	73416	522
65910	468	69102	412	69430	517	69792	524	70338	537	70565	415	71932	452	73417	478
65916	532	69103	412	69437	542	69793	418	70339	530	70567	416	71945	453	73418	456
65917	532	69105	413	69440	455	69794	458	70340	472	70569	472	71985	492	73419	520
65937	379	69106	412	69442	459	69796	474	70345	495	70577	509	72009	524	73420	455
65948	468	69108	413	69444	520	69799	539	70347	495	70578	554	72022	524	73422	449
65949	468	69109	413	69445	418	69800	539	70350	452	70579	509	72024	524	73423	554
65950	468	69111	413	69446	416	69801	460	70352	530	70580	509	72040	524	73424	571
65960	197	69131	510	69447	416	69806	446	70356	459	70582	455	72049	524	73426	544
65961	197	69133	560	69448	419	69809	446	70357	453	70585	455	72055	525	73427	523
65962	197	69138	506	69449	418	69810	446	70358	530	70587	509	72072	522	73430	414
65963	197	69143	519	69455	519	69813	445	70359	530	70588	535	72083	522	73433	489
65964	197	69144	510	69456	517	69815	445	70362	536	70593	545	72091	525	73434	490
65965	221	69148	510	69460	517	69825	446	70363	511	70602	415	72097	525	73436	452
65966	221	69149	515	69461	415	70102	447	70366	539	70608	544	72118	523	73437	522
65967	197	69157	473	69463	493	70103	447	70368	536	70609	544	72133	523	73439	518
65968	229	69162	514	69464	553	70105	447	70370	536	70610	544	72148	525	73440	486
65970	197	69168	487	69469	535	70109	447	70371	414	70612	544	72155	526	73442	494
65971	197	69170	511	69470	540	70110	447	70372	453	70616	544	72176	526	73443	518
65972	197	69173	553	69473	535	70112	447	70373	453	70617	544	72207	452	73444	507
65973	197	69176	571	69473	415	70115	447	70374	449	70632	521	72230	452	73445	447
65974	197	69179	536	69475	513	70117	447	70375	453	70667	415	72238	452	73446	447
65975	197	69182	537	69477	416	70123	447	70376	561	70699	415	72246	453	73447	447
66004	504	69183	536	69481	538	70127	447	70378	520	70713	416	72255	524	73449	553
66005	504	69184	534	69486	535	70128	447	70383	531	70730	526	72285	522	73450	515
66006	504	69190	474	69487	537	70129	447	70388	473	70736	418	72293	524	73451	469
66007	504	69192	473	69494	537	70136	447	70389	473	70747	418	72295	524	73455	537
66008	504	69193	414	69500	492	70137	447	70393	511	70753	418	72296	526	73456	534
66009	504	69196	514	69504	513	70138	447	70402	473	70820	413	72297	526	73457	530
66050	203	69199	476	69510	513	70141	447	70406	507	70833	417	72298	526	73458	486
66051	203	69202	487	69511	486	70152	447	70409	507	70846	417	72328	527	73460	511
66052	203	69206	487	69515	554	70153	447	70410	486	70852	413	72329	527	73461	531
66053	203	69210	415	69531	508	70161	447	70416	541	70855	490	72336	527	73463	471
66054	203	69215	538	69539	571	70167	447	70419	454	70863	417	72341	526	73464	553
66055	203	69221	458	69540	514	70202	472	70422	512	70885	413	72342	523	73466	523
66056	203	69226	530	69541	514	70205	553	70423	454	70915	476	72343	526	73467	478
66060	203	69228	449	69546	537	70206	450	70426	545	70923	476	72344	526	73469	418
66061	203	69229	530	69551	509	70207	450	70428	561	70947	477	72345	526	73470	532
66062	203	69232	494	69558	455	70208	450	70430	456	70949	477	72346	526	73471	494
66063	203	69237	511	69561	515	70212	571	70436	520	70976	477	72347	526	73472	412
66064	203	69238	517	69562	571	70217	450	70437	512	70997	499	72348	526	73473	478
66065	203	69243	489	69566	417	70218	571	70438	512	70998	500	72349	527	73474	528
66066	203	69246	489	69567	528	70220	416	70442	518	70999	500	72355	527	73475	537
66067	203	69250	495	69568	523	70223	570	70446	515	71015	478	72392	451	73476	415
66219	185	69252	458	69573	457	702									

Part Number Index

BradyID.com/s36

Catalog #	Pg	Catalog #	Pg	Catalog #	Pg	Catalog #	Pg	Catalog #	Pg	Catalog #	Pg	Catalog #	Pg
73486	524	73938	352	75157	572	76168	328	76638	95	77207	307	78260	490
73487	524	73939	352	75158	572	76171	328	76639	95	77208	307	78261	581
73489	451	73940	352	75161	575	76192	328	76640	95	77210	307	78262	581
73490	458	73941	352	75162	575	76193	328	76641	95	77216	307	78263	581
73493	494	73942	352	75166	563	76197	328	76642	95	77217	307	78264	581
73509	477	73943	352	75178	575	76198	328	76643	95	77219	307	78268	306
73510	477	73944	352	75180	575	76222	324	76644	95	77221	307	78272	579
73513	477	73945	352	75183	572	76259	464	76645	95	77224	307	78273	579
73538	495	73946	352	75190	564	76290	544	76646	95	77226	307	78788	374
73540	473	73947	352	75198	572	76299	395	76647	95	77995	446	78985	300
73542	478	73948	352	75199	576	76300	395	76648	95	77997	446	78986	300
73545	478	73949	352	75200	576	76301	395	76649	95	77998	446	78987	300
73558	477	73950	352	75201	576	76302	395	76650	95	77999	446	78988	300
73860	352	73951	352	75203	576	76303	395	76651	95	78000	558	78989	300
73861	352	74097	493	75205	576	76305	396	76652	95	78002	558	78990	300
73862	352	74111	510	75206	576	76306	396	76653	95	78003	558	78991	578
73863	352	74132	511	75207	576	76308	300	76654	95	78004	558	78993	578
73864	352	74170	539	75211	568	76309	300	76686	98	78007	558	78998	578
73865	352	74187	511	75212	568	76310	300	76687	98	78009	558	79936	349
73866	352	74226	511	75215	572	76312	300	76688	98	78010	558	80007	486
73867	352	74264	512	75219	564	76313	300	76689	98	78011	558	80009	486
73868	352	74270	507	75226	564	76316	300	76691	98	78013	558	80012	400
73869	352	74299	512	75227	564	76317	300	76692	98	78014	558	80013	400
73870	352	74305	512	75234	561	76318	300	76693	98	78015	558	80014	400
73871	352	74337	537	75444	412	76319	300	76694	98	78016	558	80016	400
73872	352	74350	508	75478	414	76321	300	76695	98	78018	558	80017	486
73873	352	74385	508	75510	416	76394	464	76696	98	78019	558	80027	478
73874	352	74391	415	75590	473	76415	374	76697	98	78031	558	80028	478
73875	352	74415	517	75639	452	76430	303	76698	98	78033	558	80029	479
73877	352	74429	517	75662	453	76431	303	76699	98	78035	558	80032	400
73878	352	74442	509	75670	523	76432	303	76700	98	78036	558	80033	400
73879	352	74455	509	75900	531	76433	303	76701	98	78037	557	80034	400
73880	352	74464	456	75914	531	76434	465	76702	98	78047	558	80036	400
73882	352	74479	538	75919	531	76436	465	76703	98	78049	558	80035	479
73883	352	74509	509	75928	514	76437	465	76704	98	78055	558	80037	521
73885	352	74520	450	75962	493	76438	465	76705	97	78063	446	80040	479
73886	352	74542	529	75963	493	76439	465	76706	97	78064	446	80041	479
73887	352	74581	531	75970	479	76501	358	76707	97	78066	446	80048	479
73888	352	74609	511	75971	479	76502	358	76711	96	78067	446	80049	566
73889	352	74616	456	75972	526	76503	358	76712	96	78073	446	80055	573
73890	352	74630	532	75973	526	76504	358	76713	96	78083	446	80060	573
73891	352	74680	509	75974	450	76505	358	76714	97	78084	446	80061	573
73892	352	74740	533	75975	450	76506	358	76715	97	78086	446	80067	575
73893	352	74764	533	75976	533	76507	358	76716	97	78091	302	80068	575
73894	352	74829	542	75977	533	76509	358	76720	98	78092	302	80071	577
73895	352	74837	542	75978	476	76510	358	76721	98	78130	300	80072	577
73896	352	74844	542	75979	535	76512	358	76722	98	78131	300	80073	576
73897	352	74850	542	75980	535	76514	358	76737	34	78132	300	80074	576
73898	352	74855	542	75980	446	76598	95	76739	99	78136	300	80075	576
73899	352	74871	446	76005	446	76599	95	76741	99	78137	300	80076	573
73900	352	74886	543	76006	446	76600	95	76743	99	78140	300	80077	563
73901	352	74900	543	76009	446	76601	95	76745	99	78141	300	80078	564
73902	352	74907	543	76013	446	76602	95	76747	99	78142	300	80091	574
73903	352	74940	493	76015	446	76603	95	76749	99	78146	302	80094	574
73904	352	74948	536	76021	446	76604	95	76751	99	78147	302	80095	575
73905	352	74966	493	76034	446	76606	95	76752	99	78148	302	80097	560
73906	352	74982	539	76036	446	76607	95	76759	99	78149	302	80098	574
73907	352	75042	532	76040	446	76608	95	76760	99	78150	302	80099	575
73908	352	75062	577	76045	446	76609	95	76761	99	78160	302	80100	573
73909	352	75063	573	76050	446	76610	95	76762	99	78161	302	80101	573
73910	352	75066	575	76053	446	76611	95	76763	99	78162	302	80102	573
73911	352	75071	562	76056	446	76612	95	76766	99	78163	302	80103	573
73913	352	75082	570	76061	446	76613	95	76767	99	78187	302	80104	573
73914	352	75086	560	76063	446	76614	95	76770	99	78188	302	80105	575
73915	352	75091	571	76064	446	76615	95	76771	99	78189	302	80106	575
73916	352	75093	573	76065	472	76616	95	76774	99	78190	302	80108	574
73917	352	75094	573	76066	477	76617	95	76775	99	78191	302	80109	575
73918	352	75096	560	76067	477	76618	95	76778	99	78193	302	80110	566
73919	352	75097	571	76070	530	76619	95	76779	99	78194	302	80111	581
73920	352	75101	561	76072	473	76620	95	76782	99	78195	302	80112	581
73921	352	75103	560	76073	448	76621	95	76786	99	78196	302	80117	309
73922	352	75110	574	76077	466	76622	95	76787	99	78197	302	80118	309
73923	352	75111	574	76080	448	76623	95	76790	99	78198	302	80125	309
73924	352	75113	574	76081	541	76624	95	76791	99	78199	302	80127	309
73925	352	75115	571	76082	541	76625	95	76794	99	78227	519	80129	309
73926	352	75118	570	76085	457	76626	95	76795	99	78234	306	80130	309
73927	352	75123	571	76087	575	76627	95	76811	92	78235	306	80131	309
73928	352	75126	507	76088	576	76628	95	76870	491	78238	306	80160	491
73929	352	75137	560	76090	572	76629	95	76871	566	78239	306	80161	488
73930	352	75140	562	76092	453	76630	95	76879	544	78241	306	80162	490
73931	352	75141	562	76093	554	76631	95	76898	307	78246	306	80167	489
73932	352	75142	562	76095	495	76632	95	77200	307	78247	306	80173	490
73933	352	75143	562	76096	495	76633	95	77201	307	78248	306	80174	490
73934	352	75144	563	76097	446	76634	95	77202	307	78254	306	80201	475
73935	352	75147	571	76098	446	76635	95	77203	307	78257	306	80202	475
73936	352	75155	572	76100	446	76636	95	77204	307	78258	306	80204	473
73937	352	75156	572	76101	446	76637	95	77205	307	78259	306	80207	476

Part Number Index

BradyID.com/s36

Catalog #	Pg	Catalog #	Pg	Catalog #	Pg	Catalog #	Pg	Catalog #	Pg	Catalog #	Pg	Catalog #	Pg	Catalog #	Pg
80885	485	81900	482	83571	346	84002	412	84151	416	84291	448	84440	455	84627	477
80899	485	81902	482	83573	349	84003	412	84152	416	84292	448	84446	455	84628	477
80903	485	81903	482	83576	349	84006	412	84153	416	84293	448	84457	455	84630	477
80937	306	81904	482	83585	349	84007	412	84154	416	84294	448	84458	455	84632	477
80938	306	81906	482	83589	349	84008	412	84155	416	84295	448	84459	455	84633	477
80943	306	81907	482	83590	349	84009	412	84156	416	84296	448	84461	455	84634	477
80944	306	81908	482	83596	349	84010	412	84159	416	84297	448	84462	455	84635	489
80958	306	81910	482	83598	349	84011	412	84160	416	84298	448	84463	456	84636	489
80959	306	81911	482	83599	349	84012	412	84167	416	84301	449	84464	456	84641	478
80960	306	81912	482	83600	349	84013	412	84168	416	84302	449	84466	456	84642	478
80961	306	81913	482	83601	349	84014	412	84171	416	84313	449	84467	456	84643	478
81728	351	81914	482	83604	349	84015	412	84172	416	84314	449	84468	456	84644	478
81729	303	81915	482	83607	349	84018	412	84173	416	84315	449	84469	456	84647	478
81760	207	81916	482	83612	349	84019	412	84174	416	84316	449	84471	456	84648	478
81761	207	81918	482	83614	349	84026	412	84175	416	84317	449	84472	456	84651	479
81762	207	81919	482	83615	349	84027	412	84176	416	84318	449	84473	456	84652	479
81763	335	81920	482	83654	432	84032	413	84177	523	84319	449	84476	456	84653	479
81764	335	81921	482	83658	432	84033	413	84178	523	84320	449	84477	456	84654	479
81765	207	81922	482	83660	422	84034	413	84179	523	84321	449	84478	456	84661	476
81766	207	81923	482	83664	421	84035	413	84181	416	84322	449	84483	457	84662	476
81767	207	81925	482	83669	433	84036	413	84182	416	84323	450	84484	457	84663	476
81768	207	81963	390	83675	425	84037	413	84183	417	84324	450	84487	457	84664	476
81769	207	81991	333	83677	428	84038	413	84184	417	84326	450	84488	457	84665	476
81770	207	82586	389	83678	431	84039	413	84185	417	84327	450	84491	457	84666	476
81771	335	82587	389	83679	426	84042	451	84186	417	84332	450	84492	457	84667	476
81772	335	82588	389	83680	427	84043	451	84187	417	84333	450	84493	457	84668	476
81773	207	82589	389	83681	427	84054	413	84188	417	84334	450	84494	457	84669	476
81791	482	82590	389	83731	427	84055	413	84189	417	84335	450	84497	458	84670	477
81792	482	82591	389	83732	428	84056	413	84190	417	84337	450	84498	458	84671	477
81794	482	82592	389	83733	429	84057	413	84191	417	84338	450	84507	459	84672	477
81795	482	82593	389	83735	427	84060	413	84192	417	84339	450	84508	459	84673	477
81796	482	82594	389	83736	430	84061	413	84195	417	84340	450	84511	460	84674	477
81797	482	82595	468	83737	426	84062	413	84196	417	84341	450	84516	466	84675	477
81798	482	82596	468	83738	426	84063	413	84197	417	84345	451	84529	530	84676	477
81799	482	83400	349	83741	422	84064	413	84198	417	84346	451	84530	530	84677	477
81800	482	83413	349	83748	421	84065	413	84199	417	84349	451	84531	530	84678	477
81801	482	83414	349	83751	432	84066	414	84200	417	84350	451	84532	530	84679	477
81802	482	83415	349	83753	445	84067	414	84203	417	84351	451	84533	530	84680	477
81803	482	83416	349	83754	421	84068	414	84204	417	84352	451	84534	530	84681	488
81804	482	83418	349	83756	423	84069	414	84205	417	84355	451	84535	531	84682	488
81805	482	83421	349	83757	423	84074	414	84206	417	84356	451	84536	531	84683	488
81806	482	83424	349	83758	432	84075	414	84207	417	84357	451	84537	531	84684	491
81807	482	83430	349	83759	432	84080	453	84208	417	84358	451	84538	531	84685	478
81808	482	83432	349	83760	432	84081	453	84211	417	84361	451	84542	466	84686	478
81809	482	83436	349	83761	432	84082	414	84212	417	84362	451	84545	532	84687	478
81810	482	83448	349	83763	432	84083	414	84213	417	84363	451	84546	532	84688	478
81811	482	83449	349	83764	432	84084	414	84215	417	84364	451	84547	532	84689	479
81813	482	83450	349	83766	433	84085	414	84216	445	84366	451	84548	532	84690	479
81814	482	83451	349	83767	433	84086	414	84217	445	84368	451	84549	532	84692	470
81815	482	83453	349	83768	430	84089	414	84218	417	84369	451	84550	532	84695	470
81816	482	83454	349	83839	425	84090	414	84219	417	84370	451	84551	539	84696	470
81818	482	83456	349	83841	428	84091	414	84222	417	84371	451	84552	532	84697	470
81819	482	83460	349	83874	432	84092	414	84223	417	84372	451	84553	532	84698	470
81820	482	83466	349	83877	432	84095	414	84226	417	84375	452	84554	532	84699	470
81822	482	83468	349	83883	422	84096	414	84227	417	84376	452	84555	532	84700	470
81823	482	83477	349	83887	421	84097	414	84234	545	84379	452	84556	532	84702	470
81824	482	83478	349	83892	433	84101	414	84236	418	84387	453	84557	532	84703	470
81826	482	83479	349	83896	425	84103	415	84237	418	84388	453	84558	466	84704	470
81827	482	83484	349	83898	428	84104	415	84238	418	84393	453	84559	466	84705	470
81828	482	83489	349	83899	431	84107	415	84239	418	84394	453	84560	466	84706	470
81830	482	83496	349	83900	426	84108	415	84240	418	84395	453	84561	466	84707	470
81831	482	83498	349	83901	427	84110	415	84245	418	84396	453	84562	454	84708	507
81834	482	83499	349	83902	427	84111	415	84246	418	84397	453	84563	454	84710	470
81835	482	83501	349	83907	428	84112	415	84247	418	84398	453	84564	467	84711	470
81838	482	83503	349	83908	429	84113	415	84249	418	84399	453	84566	467	84712	470
81839	482	83505	349	83910	427	84114	415	84251	418	84400	453	84567	454	84713	470
81840	482	83510	349	83911	430	84115	415	84252	418	84403	453	84568	454	84714	470
81842	482	83514	349	83912	426	84119	415	84256	418	84407	454	84569	467	84715	470
81843	482	83515	349	83913	426	84120	415	84257	418	84408	454	84570	467	84716	470
81845	482	83517	349	83916	422	84122	415	84258	418	84409	454	84571	413	84717	470
81869	303	83518	349	83923	421	84123	415	84259	418	84411	454	84572	413	84718	470
81873	303	83520	349	83925	421	84124	415	84260	418	84412	454	84575	468	84719	470
81879	482	83522	349	83928	445	84129	415	84263	418	84421	454	84577	468	84720	470
81882	482	83527	349	83929	421	84130	415	84266	419	84422	454	84583	542	84721	470
81883	482	83530	349	83931	423	84131	415	84267	419	84423	454	84586	542	84725	470
81884	482	83537	349	83932	423	84132	415	84269	419	84425	454	84601	544	84726	470
81886	482	83540	349	83933	432	84133	415	84270	419	84426	454	84602	544	84727	470
81887	482	83545	349	83934	432	84134	415	84274	419	84427	454	84603	544	84730	470
81888	482	83550	349	83935	432	84138	415	84275	419	84428	455	84604	544	84732	415
81890	482	83551	349	83936	432	84140	415	84276	419	84429	455	84605	544	84733	415
81891	482	83553	349	83938	432	84141	416	84277	419	84430	455	84617	475	84736	416
81892	482	83554	349	83939	432	841									

Part Number Index

BradyID.com/s36

Catalog #	Pg	Catalog #	Pg	Catalog #	Pg	Catalog #	Pg	Catalog #	Pg	Catalog #	Pg	Catalog #	Pg
84747	471	84878	473	85035	537	85185	453	85346	494	85554	445	85757	506
84748	471	84879	473	85036	537	85186	453	85349	494	85562	458	85777	506
84749	471	84880	473	85038	537	85187	453	85350	494	85563	458	85778	506
84750	471	84883	473	85039	537	85188	453	85352	494	85564	458	85779	506
84751	471	84884	473	85040	537	85189	522	85353	494	85565	458	85780	506
84752	471	84885	473	85041	537	85190	522	85354	494	85566	459	85781	506
84755	471	84886	473	85042	537	85191	453	85355	494	85567	459	85783	506
84756	471	84887	473	85045	537	85192	453	85356	495	85572	518	85791	506
84757	471	84888	473	85046	537	85197	486	85357	495	85573	518	85792	506
84758	471	84889	473	85049	537	85198	486	85358	495	85580	518	85793	506
84761	471	84895	473	85050	537	85199	486	85359	495	85581	518	85797	506
84762	471	84897	473	85051	537	85200	486	85360	495	85582	518	85799	506
84767	471	84903	474	85052	537	85206	486	85361	495	85583	518	85801	506
84768	471	84904	474	85053	538	85209	486	85362	495	85584	518	85813	506
84769	471	84905	474	85054	538	85210	486	85363	495	85592	518	85819	506
84770	479	84906	474	85055	538	85211	518	85368	495	85593	518	85820	506
84771	479	84907	521	85056	538	85212	518	85369	495	85598	518	85828	507
84774	529	84908	521	85057	538	85219	486	85370	495	85599	518	85831	507
84775	529	84917	474	85058	538	85220	486	85371	495	85601	479	85838	507
84776	529	84918	474	85066	538	85221	486	85375	495	85604	518	85844	507
84777	529	84924	474	85069	539	85222	486	85377	495	85605	518	85846	504
84778	529	84925	474	85070	539	85225	487	85378	495	85606	518	85847	504
84779	529	84926	474	85071	539	85228	487	85382	448	85607	518	85848	504
84780	530	84927	474	85072	540	85231	487	85383	448	85610	518	85849	504
84782	530	84928	474	85074	540	85236	487	85384	448	85614	518	85854	507
84783	530	84929	472	85075	540	85237	487	85385	448	85620	518	85855	507
84784	531	84933	472	85076	540	85239	487	85386	448	85629	518	85856	507
84785	531	84934	472	85079	529	85240	487	85406	309	85631	518	85857	507
84788	531	84937	474	85080	529	85241	487	85407	449	85632	519	85858	507
84789	531	84938	474	85083	507	85242	487	85408	449	85633	519	85859	507
84790	531	84941	474	85084	507	85243	487	85409	449	85634	518	85860	507
84791	531	84942	474	85085	508	85244	487	85410	449	85639	486	85861	507
84792	531	84943	474	85086	508	85248	488	85411	449	85642	518	85866	507
84793	531	84944	474	85087	508	85249	488	85412	449	85643	518	85867	507
84794	531	84945	474	85088	508	85253	488	85414	449	85644	518	85870	507
84795	531	84946	474	85091	508	85254	488	85417	449	85645	518	85871	507
84796	531	84949	474	85092	508	85255	489	85418	449	85648	519	85886	508
84797	531	84950	474	85093	508	85256	489	85427	570	85649	519	85887	508
84798	533	84956	474	85094	508	85257	489	85428	570	85650	519	85890	504
84799	533	84957	474	85095	509	85258	490	85437	450	85652	519	85891	504
84802	534	84958	474	85096	509	85259	490	85438	450	85653	519	85893	504
84803	534	84959	474	85097	509	85261	490	85439	450	85654	519	85896	508
84804	534	84960	474	85098	509	85262	489	85441	450	85655	519	85897	508
84805	534	84962	474	85099	509	85263	489	85442	450	85659	519	85898	508
84806	534	84963	474	85100	509	85264	489	85443	450	85662	519	85900	509
84807	534	84966	474	85101	510	85265	489	85444	450	85663	519	85901	509
84808	536	84967	474	85102	510	85267	489	85451	451	85664	519	85902	509
84809	536	84968	474	85115	512	85268	489	85452	451	85666	519	85903	509
84810	536	84971	529	85116	512	85269	489	85453	451	85667	519	85904	509
84811	536	84972	529	85117	512	85270	490	85458	452	85668	519	85905	509
84812	536	84973	529	85118	512	85271	491	85459	452	85669	519	85911	504
84813	536	84975	529	85119	511	85272	491	85476	490	85670	519	85912	504
84814	536	84976	529	85120	511	85273	491	85478	495	85671	519	85913	504
84815	536	84977	529	85129	537	85275	490	85480	478	85686	519	85919	510
84816	536	84981	530	85130	537	85276	490	85481	478	85687	519	85920	510
84817	536	84982	530	85133	515	85277	490	85482	524	85690	519	85921	510
84818	537	84983	530	85134	515	85278	490	85484	478	85691	519	85923	510
84822	538	84984	530	85135	515	85279	491	85485	453	85692	519	85924	510
84823	538	84987	531	85136	515	85280	491	85486	453	85694	519	85925	510
84824	539	84989	532	85139	516	85294	486	85489	453	85696	519	85926	510
84825	539	84990	532	85140	516	85297	492	85490	453	85697	519	85927	510
84826	539	84991	532	85141	516	85298	492	85493	453	85703	519	85928	510
84827	472	84992	532	85142	516	85299	492	85497	453	85706	520	85942	510
84828	472	84993	532	85143	516	85305	492	85498	453	85707	520	85949	510
84829	472	84994	532	85144	516	85308	493	85499	453	85708	520	85959	510
84830	472	84995	533	85145	517	85309	493	85500	453	85709	520	85960	510
84831	472	84996	533	85147	517	85310	493	85512	454	85710	520	85971	511
84832	472	84997	533	85148	486	85311	493	85521	455	85717	520	85972	511
84834	472	84998	533	85151	486	85312	493	85522	455	85720	520	85973	511
84837	472	84999	533	85152	486	85315	493	85523	478	85721	520	85974	511
84838	472	85000	533	85161	452	85316	493	85528	478	85722	520	85975	511
84843	472	85001	533	85162	452	85321	493	85531	456	85723	520	85979	511
84844	472	85002	533	85165	452	85322	493	85532	456	85724	520	85985	511
84847	472	85003	534	85166	452	85323	493	85533	456	85730	520	85986	511
84848	472	85007	534	85167	452	85324	493	85534	456	85733	520	85987	511
84851	472	85008	534	85168	452	85325	493	85535	456	85737	520	85988	511
84852	472	85011	534	85169	452	85326	493	85536	456	85738	520	85989	511
84853	472	85015	534	85170	452	85327	493	85540	478	85741	520	85990	511
84855	472	85016	534	85174	414	85328	493	85541	478	85745	520	85995	511
84856	472	85017	535	85175	452	85331	494	85545	478	85746	520	85997	511
84857	472	85018	535	85176	452	85332	494	85546	478	85747	471	85998	511
84859	472	85021	535	85179	452	85333	494	85547	457	85750	520	86007	544
84860	472	85027	535	85180	452	85334	494	85548	457	85751	520	86008	544
84865	473	85028	535	85181	452	85337	494	85549	457	85752	520	86009	544
84875	473	85029	536	85182	452	85338	494	85550	457	85753	520	86010	544
84876	473	85030	536	85183	453	85343	494	85551	307	85754	504	86011	544
84877	473	85032	536	85184	453	85344	494	85553	445	85755	504	86012	544

Part Number Index

BradyID.com/s36

Catalog #	Pg	Catalog #	Pg	Catalog #	Pg	Catalog #	Pg	Catalog #	Pg	Catalog #	Pg	Catalog #	Pg
87670	513	88057	446	88257	515	88426	524	88611	534	88848	553	89154	524
87674	467	88058	446	88258	515	88427	524	88612	534	88849	553	89155	571
87675	467	88059	446	88259	515	88428	524	88617	535	88852	553	89156	476
87677	524	88061	446	88260	515	88429	524	88618	535	88853	553	89158	445
87678	473	88063	446	88267	516	88430	524	88619	535	88860	553	89159	445
87681	473	88064	446	88268	516	88432	524	88620	535	88861	553	89163	445
87682	553	88065	446	88275	516	88433	525	88627	535	88864	553	89164	445
87684	526	88066	446	88276	516	88434	525	88628	535	88865	553	89169	445
87685	526	88101	511	88281	516	88435	525	88641	536	88866	553	89170	445
87687	526	88102	511	88283	516	88436	525	88643	536	88870	553	89171	542
87688	526	88107	511	88285	516	88437	525	88644	536	88871	553	89173	473
87689	526	88108	511	88288	516	88438	525	88645	536	88872	553	89174	414
87691	526	88109	511	88293	516	88439	525	88646	536	88873	553	89176	524
87692	200	88115	511	88298	516	88440	525	88647	536	88874	553	89256	220
87693	200	88116	511	88299	516	88441	525	88648	536	88875	553	89257	374
87694	340	88117	511	88302	505	88442	525	88649	537	88876	553	90018	566
87695	340	88119	511	88303	505	88443	524	88651	537	88877	553	90019	300
87696	340	88120	511	88304	505	88444	524	88652	537	88878	554	90020	300
87697	340	88123	511	88305	517	88445	525	88656	537	88879	554	90100	488
87698	340	88124	511	88307	517	88446	525	88659	537	88880	554	90101	488
87699	340	88127	512	88310	517	88447	525	88660	537	88881	554	90102	476
87710	340	88128	512	88311	517	88448	525	88661	538	88898	554	90103	487
87711	340	88131	512	88312	517	88449	523	88662	538	88899	554	90105	478
87712	340	88132	512	88314	517	88450	523	88663	538	88905	554	90106	491
87713	340	88135	512	88315	517	88451	525	88664	538	88908	554	90107	491
87714	440	88137	512	88316	505	88452	525	88669	538	88909	554	90109	476
87715	519	88138	512	88317	517	88453	526	88670	538	88910	554	90112	540
87716	519	88141	512	88318	517	88454	526	88677	539	88911	554	90121	538
87717	519	88142	512	88320	505	88455	456	88678	539	88914	446	90123	475
87718	545	88143	512	88323	517	88456	456	88682	528	88915	446	90128	540
87719	545	88144	512	88324	517	88457	526	88683	528	88918	446	90139	538
87732	528	88146	512	88325	517	88458	526	88684	540	88919	446	90143	438
87736	519	88152	512	88326	517	88467	526	88691	541	88922	446	90147	436
87738	528	88153	512	88327	517	88468	526	88699	541	88924	446	90149	440
87740	346	88155	512	88328	517	88469	526	88700	541	88925	446	90155	444
87742	347	88158	512	88329	517	88470	526	88702	541	88926	446	90156	443
87745	348	88160	513	88330	517	88471	527	88707	541	88927	446	90157	444
87746	348	88161	513	88345	522	88472	527	88708	541	88928	446	90158	443
87748	454	88162	513	88346	522	88475	528	88709	541	88930	446	90159	443
87750	413	88163	513	88347	522	88476	528	88710	541	88932	446	90160	443
87751	414	88164	513	88348	522	88477	528	88715	541	88933	446	90175	433
87754	414	88165	513	88351	522	88478	528	88717	541	88935	446	90183	479
87755	414	88172	513	88352	522	88479	528	88718	541	88936	543	90184	479
87757	417	88173	513	88359	453	88480	528	88725	541	88937	543	90185	492
87758	417	88174	513	88360	453	88485	528	88726	541	88938	543	90186	492
87759	414	88175	513	88363	522	88486	528	88731	542	88939	446	90187	491
87762	453	88176	513	88364	522	88491	458	88733	542	88941	446	90188	444
87763	452	88182	513	88369	522	88494	516	88734	542	88942	446	90196	539
87764	452	88183	513	88370	522	88495	539	88736	542	88944	446	90199	540
87766	448	88184	513	88371	522	88497	474	88737	542	88945	446	90261	348
87767	457	88185	513	88374	522	88498	474	88738	542	88946	446	90276	349
87768	468	88186	513	88375	522	88500	458	88739	542	88947	446	90307	346
87769	530	88187	514	88376	523	88502	494	88740	542	88948	446	90308	347
87770	530	88188	514	88377	523	88503	517	88741	542	88949	446	90331	348
87771	531	88189	514	88378	523	88504	489	88742	542	89001	446	90333	348
87772	531	88191	514	88379	523	88505	490	88743	542	89005	446	90340	345
87773	454	88192	514	88380	523	88506	458	88745	542	89016	461	90341	345
87774	470	88193	514	88381	523	88509	566	88746	542	89017	320	90343	345
87775	470	88194	514	88382	523	88511	539	88747	542	89018	320	90345	345
87776	470	88199	514	88383	523	88512	474	88748	542	89087	448	90346	345
87777	536	88205	514	88384	523	88513	517	88749	542	89088	448	90349	345
87778	531	88206	514	88386	523	88516	545	88750	542	89090	530	90350	345
87779	537	88208	514	88387	523	88517	418	88751	542	89091	530	90366	488
87780	535	88209	514	88388	523	88520	524	88752	542	89093	505	90367	490
87781	537	88215	514	88389	523	88521	517	88762	543	89097	461	90368	492
87782	509	88216	514	88392	527	88522	459	88767	543	89098	473	90369	490
87783	508	88217	515	88393	527	88525	540	88768	543	89099	473	90370	491
87784	508	88218	515	88394	523	88527	540	88769	543	89100	474	90371	489
87785	494	88221	515	88396	523	88528	495	88770	543	89104	486	90372	487
87786	494	88225	515	88397	523	88529	460	88791	553	89105	486	90373	490
87788	511	88226	515	88400	523	88530	545	88806	553	89106	486	90376	488
87790	507	88231	515	88401	523	88543	529	88810	553	89107	486	90377	488
87791	506	88234	515	88402	523	88544	529	88811	553	89110	486	90379	487
87792	513	88237	515	88403	523	88545	530	88814	553	89112	542	90380	491
87793	512	88238	515	88404	524	88546	530	88815	553	89113	446	90383	489
87795	524	88243	515	88405	524	88547	530	88816	553	89115	446	90384	490
87796	523	88244	515	88410	524	88548	530	88817	553	89128	545	90386	492
87797	525	88245	515	88411	527	88551	530	88830	553	89129	571	90400	345
87807B	483	88246	515	88412	527	88552	530	88831	553	89131	573	90401	345
87808B	483	88247	515	88413	524	88571	532	88834	553	89132	573	90402	345
87942	339	88248	515	88414	524	88572	532	88835	553	89133	560	90403	345
87982	579	88251	515	88418	524	88583	533	88838	553	89134	560	90404	345
88051	303	88252	515	88421	524	88584	533	88839	553	89135	571	90405	345
88052	446	88253	515	88422	524	88585	533	88840	553	89136	571	90406	345
88053	446	88254	515	88423	524	88586	533	88842	553	89149	490	90407	345
88054	446	88255	515	88424	524	88609	535	88843	553	89152	474	90408	345
88056	446	88256	515	88425	524	88610	535	88846	553	89153	474	90409	345

Part Number Index

BradyID.com/s36

Catalog #	Pg	Catalog #	Pg	Catalog #	Pg	Catalog #	Pg	Catalog #	Pg	Catalog #	Pg	Catalog #	Pg	Catalog #	Pg
90518	443	90792	436	91087	304	91420	358	91939	353	93625	543	95043	576	95240	415
90520	443	90793	436	91088	305	91421	358	91940	353	93627	543	95044	576	95241	416
90521	443	90795	437	91089	305	91422	358	91942	353	93629	543	95045	576	95242	416
90522	443	90797	436	91090	305	91423	358	91943	353	93631	543	95046	576	95243	416
90524	516	90799	435	91091	305	91424	358	91944	353	93634	543	95047	578	95245	416
90540	479	90803	436	91092	305	91425	358	91948	353	93636	543	95071	312	95246	416
90542	436	90804	443	91100	304	91426	358	91949	353	93637	543	95072	312	95247	416
90543	437	90805	444	91101	304	91427	358	91950	353	93638	543	95073	312	95248	416
90544	441	90807	440	91102	304	91428	358	91951	353	93640	543	95074	312	95254	415
90550	479	90808	441	91103	304	91429	358	91953	353	94008	500	95075	312	95255	415
90551	479	90809	434	91104	304	91430	358	91955	353	94014	500	95090	312	95256	415
90553	492	90810	439	91165	341	91431	358	91956	353	94022	499	95091	312	95258	415
90554	491	90811	441	91166	341	91432	358	91958	353	94027	499	95092	312	95259	415
90555	444	90816	434	91172	304	91433	358	91959	353	94029	500	95093	312	95262	416
90558	491	90817	435	91173	304	91447	304	91961	353	94044	500	95094	312	95263	416
90560	490	90818	435	91175	304	91448	304	91964	353	94054	500	95097	312	95265	416
90573	492	90819	438	91176	304	91451	304	91965	353	94105	562	95098	312	95266	416
90576	491	90820	436	91179	304	91452	304	91966	353	94106	564	95099	312	95268	415
90584	539	90821	442	91200	304	91453	304	91967	353	94112	566	95100	312	95269	522
90587	540	90839B	483	91201	304	91454	304	91968	353	94116	562	95101	312	95270	415
90607	495	90840B	483	91212	304	91455	304	91972	353	94117	562	95102	312	95272	470
90611	478	90841B	483	91213	304	91456	304	91974	353	94119	562	95103	312	95275	415
90616	476	90842B	483	91214	304	91457	304	91977	353	94120	562	95137	225	95277	456
90617	487	90844	222	91215	304	91458	304	91978	353	94123	564	95138	225	95278	415
90619	478	90845	222	91217	304	91462	304	91979	353	94124	562	95139	225	95279	416
90620	491	90847	222	91220	304	91463	304	91981	353	94127	562	95141	311	95280	416
90622	476	90848	222	91227	304	91464	304	91997	353	94130	563	95142	477	95281	416
90623	476	90850	223	91224	304	91469	304	91998	353	94142	576	95143	311	95283	416
90625	488	90851	223	91228	304	91468	304	92010	306	94143	576	95144	311	95284	415
90626	488	90853	223	91229	304	91470	304	92011	306	94144	576	95146	490	95285	416
90627	488	90854	223	91237	304	91600	305	92059	349	94145	576	95147	488	95287	473
90628	476	90885B	483	91238	304	91601	305	92116	306	94148	577	95150	311	95288	416
90629	487	90886B	483	91255	304	91603	305	92117	306	94150	573	95154	523	95289	416
90630	488	90887B	483	91256	304	91604	305	92118	306	94152	577	95155	311	95290	416
90631	478	90888B	483	91257	304	91606	305	92119	306	94163	575	95158	311	95291	416
90632	491	90891	221	91287	358	91757	348	92120	306	94174	566	95159	311	95293	416
90633	444	90892	221	91288	358	91763	349	92121	306	94175	567	95160	311	95294	416
90634	476	90893	221	91289	358	91764	349	92122	306	94180	574	95161	311	95296	416
90635	476	90895	491	91290	358	91782	349	92123	306	94181	574	95162	311	95297	416
90636	488	90910	359	91294	305	91783	349	92134	306	94183	574	95163	311	95298	416
90637	488	90912	578	91295	305	91784	349	92135	306	94185	574	95164	311	95300	416
90643	540	90913	578	91296	305	91785	349	92136	306	94190	574	95165	311	95301	416
90644	539	90923	476	91297	305	91793	349	92137	306	94192	575	95166	310	95305	416
90654	438	90924	476	91298	305	91808	349	92280	308	94195	575	95167	310	95309	416
90655	436	90926	475	91299	305	91834	346	92281	308	94197	575	95168	310	95310	416
90656	438	90927	476	91319	545	91835	346	92282	308	94199	575	95169	310	95311	416
90658	436	90928	478	91324	566	91883	353	92283	308	94209	576	95170	310	95312	416
90662	443	90929	478	91326	566	91884	353	92284	308	94210	576	95171	310	95314	416
90666	439	90930	491	91331	566	91885	353	92285	308	94211	576	95172	310	95315	416
90667	441	90931	479	91332	566	91886	353	92286	308	94212	576	95173	310	95316	416
90668	441	90935	495	91333	566	91887	353	92288	308	94213	576	95174	310	95317	416
90670	443	90939	478	91334	566	91888	353	92289	308	94218	577	95175	310	95318	416
90674	440	90940	476	91336	567	91889	353	92400	496	94222	575	95193	310	95321	415
90680	440	90941	477	91351	566	91890	353	92404	496	94225	573	95195	310	95324	416
90685	444	90942	488	91352	566	91891	353	92405	496	94234	575	95196	310	95326	412
90686	444	90943	488	91354	566	91892	353	92406	496	94235	575	95197	310	95327	412
90687	443	90944	476	91356	567	91893	353	92407	496	94237	575	95198	310	95328	412
90690	443	90946	488	91357	566	91894	353	92408	496	94240	576	95199	313	95329	412
90691	443	90947	478	91358	566	91895	353	92414	302	94307	575	95200	313	95330	412
90704	445	90948	491	91359	566	91896	353	92415	302	94336	566	95201	313	95331	412
90706	433	90949	444	91360	566	91897	353	92416	302	94917	307	95202	313	95332	412
90707	433	90950	476	91362	567	91898	353	92417	302	94996	453	95205	313	95333	412
90710	459	90951	476	91363	567	91899	353	93242	358	94998	453	95206	313	95335	412
90713	479	90952	488	91370	566	91900	353	93243	358	94999	453	95207	313	95338	412
90714	479	90953	488	91371	566	91901	353	93247	358	95000	453	95208	313	95339	412
90718	491	90960	539	91372	566	91906	353	93248	358	95001	453	95211	415	95340	412
90720	538	90964	475	91375	567	91907	353	93252	358	95002	453	95212	415	95341	412
90721	540	90966	478	91376	566	91909	353	93257	358	95003	453	95213	415	95343	412
90722	540	90971	303	91377	566	91910	353	93258	358	95006	458	95214	415	95344	412
90723	539	90972	303	91378	566	91911	353	93262	358	95007	458	95216	415	95345	412
90725	540	90973	303	91384	567	91913	353	93267	358	95008	458	95218	395	95346	412
90727	539	90974	303	91386	567	91914	353	93272	358	95009	458	95219	395	95347	412
90729	540	90975	490	91387	567	91915	353	93275	301	95010	458	95220	395	95348	412
90731	538	90976	488	91388	567	91916	353	93390	358	95011	458	95221	395	95349	412
90734	439	90988	491	91389	567	91917	353	93391	358	95012	466	95222	395	95351	469
90736	438	90992	492	91408	358	91918	353	93392	358	95013	466	95223	395	95352	469
90740	436	90993	492	91409	358	91920	353	93394	358	95014	466	95224	395	95356	414
90750	444	90994	491	91410	358	91921	353	93395	358	95015	466	95225	395	95357	414
90751	443	90996	492	91411	358	91925	353	93396	358	95018	466	95226	395	95359	414
90752	443	91010	566	91412	358	91926	353	93397	358	95027	557	95227	395	95360	414
90776	479	91020	489	91413	358	91930	353	93600	542	95036	580	95228	395	95361	414
90777	479	91031	490	91414	358										

Part Number Index

BradyID.com/s36

Catalog #	Pg	Catalog #	Pg	Catalog #	Pg	Catalog #	Pg	Catalog #	Pg	Catalog #	Pg	Catalog #	Pg
95368	413	95478	555	96159	387	97205	578	99220	97	101975	333	102075	334
95369	413	95479	555	96160	387	97206	578	99221	97	101976	333	102076	334
95370	413	95481	555	96162	387	97207	578	99289	378	101977	333	102077	334
95371	413	95483	555	96163	387	97208	578	99290	232	101978	333	102078	334
95372	413	95484	555	96164	387	97209	578	99292	232	101979	333	102079	334
95373	413	95485	555	96165	387	97210	578	99293	232	101980	333	102080	334
95375	415	95486	555	96167	387	97211	578	99296	232	101981	333	102081	334
95376	415	95487	555	96168	387	97542	346	99297	232	101982	333	102082	334
95377	415	95488	555	96170	387	97543	346	99300	232	101983	333	102083	334
95378	415	95489	556	96171	387	97544	347	99302	232	101991	333	102084	334
95379	415	95491	556	96173	387	97545	347	99303	232	101992	333	102085	334
95380	415	95492	556	96175	387	97597	348	99305	235	101993	333	102086	334
95381	415	95493	556	96177	387	97609	496	99307	235	101994	333	102087	334
95382	415	95494	556	96178	387	97610	496	99308	235	101995	333	102088	334
95389	414	95495	556	96179	387	97611	496	99310	235	101996	333	102089	334
95390	414	95496	556	96180	387	97613	496	99312	235	101997	333	102090	334
95391	414	95498	521	96222	333	97614	496	99313	235	101998	333	102091	334
95392	414	95499	521	96229	276	97615	496	99320	237	101999	333	102092	334
95393	413	95500	521	96230	313	97616	496	99321	237	102000	333	102093	334
95394	413	95501	521	96231	313	97626	348	99324	237	102001	333	102094	334
95395	413	95502	521	96232	313	97627	346	99326	494	102002	333	102095	334
95396	413	95503	521	96233	313	97628	346	99500	194	102003	333	102096	334
95397	413	95504	487	96234	313	97738	95	99504	194	102004	333	102097	334
95398	413	95505	487	96235	313	97739	95	99508	194	102005	333	102098	334
95399	413	95538	232	96236	313	97740	95	99512	194	102006	333	102099	334
95400	413	95540	235	96237	313	97741	95	99516	194	102007	333	102100	334
95401	469	95548	232	96246	313	97742	95	99520	194	102008	333	102101	334
95407	414	95550	232	96247	313	97743	95	99524	194	102009	333	102102	334
95410	521	95553	232	96248	313	97744	95	99528	194	102010	333	102103	334
95411	556	95559	446	96249	313	97745	95	99533	194	102011	333	102104	334
95412	556	95563	446	96250	313	98165	305	99539	194	102012	333	102105	334
95413	557	95635	312	96251	313	98166	305	99543	194	102013	333	102106	334
95414	557	95643	312	96252	313	98167	305	99548	194	102014	333	102107	334
95415	557	95644	312	96253	313	98168	305	99552	192	102015	333	102108	334
95416	557	95645	312	96262	313	98169	305	99556	192	102016	333	102109	334
95417	557	95646	312	96263	313	98170	305	99564	192	102017	333	102110	334
95418	555	95647	312	96264	313	98171	305	99570	192	102018	333	102111	334
95419	416	95648	312	96265	313	98172	305	99576	192	102019	333	102113	334
95420	557	95649	312	96266	313	98173	305	99580	192	102020	333	102114	334
95421	557	95650	312	96267	313	98174	305	99608	195	102021	333	102115	334
95423	557	95651	312	96268	313	98175	305	99609	195	102024	396	102116	334
95424	557	95652	312	96269	313	98176	305	99610	195	102025	396	102117	334
95426	556	95653	312	96270	313	98177	305	99611	195	102026	396	102118	334
95427	556	95654	312	96271	313	98178	305	99612	195	102027	396	102119	334
95428	556	95655	312	96272	313	98219	204	99613	195	102030	396	102120	334
95429	557	95656	312	96273	313	98356	353	99615	195	102032	334	102121	334
95430	557	95657	312	96274	313	98357	353	99616	195	102033	334	102122	334
95431	556	95658	312	96275	313	98358	353	99617	195	102034	334	102123	334
95432	556	95659	312	96276	313	98368	353	99618	195	102035	334	102124	334
95433	556	95660	312	96277	313	98378	353	99619	195	102036	334	102125	334
95434	556	95661	312	96278	313	98455	302	99620	195	102037	334	102126	334
95435	556	95662	312	96279	313	98457	302	99668	197	102038	334	102127	334
95436	556	95663	312	96280	313	98459	302	99676	236	102039	334	102128	334
95437	557	95664	312	96281	313	98487	353	99677	236	102040	334	102129	334
95438	557	95665	312	96282	313	98488	353	99678	236	102041	334	102130	334
95442	417	95666	312	96283	313	98489	353	99679	236	102042	334	102131	334
95443	417	95667	312	96284	313	98490	353	99680	236	102043	334	102132	334
95444	418	95668	312	96285	313	98491	353	99681	236	102044	334	102133	334
95445	418	95669	312	96286	313	98492	353	99682	230	102045	334	102134	334
95446	418	95670	312	96287	313	98493	353	99684	230	102046	334	102135	334
95447	419	95671	312	96288	313	98494	353	99685	230	102047	334	102136	334
95448	419	95672	312	96289	313	98495	353	99686	230	102048	334	102137	334
95450	557	95673	312	96290	313	98496	353	99687	230	102049	334	102138	334
95451	557	95674	312	96291	313	98497	353	99688	230	102050	334	102139	334
95452	557	95675	312	96292	313	98499	353	99689	231	102051	334	102140	334
95453	557	95677	313	96293	313	98621	353	99690	231	102052	334	102141	334
95455	557	95678	313	96294	313	98838	353	99691	231	102053	334	102142	334
95456	557	95679	313	96295	313	98844	353	99693	244	102054	334	102143	334
95457	557	95680	313	96296	313	98848	341	99694	244	102055	334	102144	334
95458	556	95681	313	96297	313	98849	341	99696	244	102056	334	102145	334
95459	556	95682	313	96907	499	98850	341	99697	244	102057	334	102146	334
95461	556	95687	473	96908	500	98851	341	99699	244	102058	334	102147	334
95462	555	95688	312	96920	309	98853	341	99700	244	102059	334	102148	334
95463	557	95689	312	96921	309	98854	341	99703	244	102060	334	102149	334
95465	555	95690	312	96922	309	98855	341	99704	244	102061	334	102150	334
95466	555	95772	428	96923	309	98857	341	99706	244	102062	334	102151	334
95467	555	95755	541	96950	309	98858	341	99707	244	102063	334	102152	334
95468	555	96060	97	96951	309	98859	341	99709	242	102064	334	102153	334
95469	555	96061	97	96952	309	99162	241	99710	242	102066	334	102154	334
95470	555	96062	97	96953	309	99167	79	101349	304	102067	334	102155	334
95471	555	96087	458	96954	309	99168	79	101416	236	102068	334	102157	334
95472	555	96089	99	96955	309	99169	79	101956	192	102069	334	102158	334
95473	555	96090	458	97084	309	99170	79	101957	194	102070	334	102159	334
95474	555	96155	387	97198	401	99175	374	101958	194	102071	334	102160	334
95475	555	96156	387	97199	401	99195	374	101963	195	102072	334	102161	334
95476	555	96157	387	97200	579	99199	374	101973	333	102073	334	102162	334
95477	555	96158	387	97204	578	99219	97	101974	333	102074	334	102163	334

Part Number Index

BradyID.com/s36

Catalog #	Pg	Catalog #	Pg	Catalog #	Pg	Catalog #	Pg	Catalog #	Pg	Catalog #	Pg	Catalog #	Pg
104348	295	104475	296	105575	358	105724	205	105884	195	106023	460	106110	350
104349	295	104476	296	105577	358	105728	529	105885	195	106024	460	106111	350
104370	295	104477	296	105634	206	105729	529	105886	192	106025	460	106112	350
104371	295	104478	296	105635	206	105730	529	105887	192	106026	460	106113	350
104372	295	104479	296	105636	206	105734	529	105888	192	106027	460	106114	350
104373	295	104480	296	105637	206	105735	350	105889	192	106028	460	106115	350
104374	295	104481	296	105638	206	105736	350	105890	192	106029	460	106116	350
104375	295	104482	296	105639	206	105737	350	105891	192	106030	460	106117	350
104376	295	104483	296	105640	206	105738	350	105892	192	106031	460	106118	350
104377	295	104486	497	105641	206	105739	350	105893	192	106032	460	106119	350
104378	295	104487	497	105642	206	105740	350	105894	194	106033	460	106120	350
104379	295	104488	497	105643	206	105741	350	105895	194	106034	460	106121	350
104400	296	104489	497	105644	206	105742	350	105896	194	106035	460	106122	350
104401	296	104490	497	105645	206	105743	350	105897	194	106036	460	106123	350
104402	296	104491	497	105646	206	105744	350	105898	194	106037	460	106124	350
104403	296	104492	497	105647	206	105745	350	105899	194	106038	460	106125	350
104404	296	104493	497	105648	206	105746	350	105900	194	106039	460	106126	350
104405	296	104494	497	105649	206	105747	350	105901	194	106040	460	106127	350
104406	296	104495	497	105650	206	105748	350	105902	195	106041	460	106128	350
104407	296	104496	497	105651	206	105749	350	105903	195	106042	460	106129	350
104408	296	104497	497	105652	206	105750	350	105904	195	106043	460	106130	350
104409	296	104498	497	105653	206	105751	350	105905	241	106044	460	106131	350
104410	296	104499	497	105654	206	105752	350	105906	241	106045	460	106132	350
104411	296	104500	497	105655	206	105753	350	105909	96	106046	460	106133	350
104412	296	104501	497	105656	206	105754	350	105910	96	106047	460	106134	350
104413	296	104502	497	105657	206	105755	350	105911	96	106048	460	106135	350
104414	296	104503	497	105658	206	105756	350	105912	82	106049	460	106136	350
104415	296	104504	497	105659	206	105757	350	105913	82	106050	460	106137	350
104416	296	104505	497	105660	206	105758	350	105914	82	106051	460	106138	350
104417	296	104506	497	105661	206	105759	350	105928	243	106052	460	106139	350
104418	296	104507	497	105662	206	105760	350	105929	243	106053	460	106140	350
104419	296	104508	497	105663	206	105761	350	105930	243	106054	460	106141	350
104420	296	104509	497	105664	206	105763	350	105931	243	106055	460	106142	350
104421	296	104510	497	105665	206	105764	350	105932	243	106056	460	106143	350
104422	296	104511	497	105666	206	105765	350	105933	243	106057	460	106144	350
104423	296	104512	497	105667	206	105766	350	105934	243	106058	460	106145	350
104424	296	104513	497	105668	206	105767	350	105935	243	106059	460	106146	350
104425	296	104520	296	105669	206	105768	350	105936	243	106060	460	106147	350
104426	296	104521	296	105670	206	105769	350	105937	243	106061	460	106148	350
104427	296	104522	296	105671	206	105770	350	105938	243	106062	460	106149	350
104428	296	104523	296	105672	206	105771	350	105939	243	106063	350	106150	350
104429	296	104524	296	105673	206	105772	350	105940	243	106064	350	106151	350
104430	296	104525	296	105674	206	105773	350	105941	243	106065	350	106152	350
104431	296	104526	296	105675	206	105774	350	105942	243	106066	350	106153	350
104432	296	104527	296	105676	206	105775	350	105954	240	106067	350	106154	350
104433	296	104528	296	105677	206	105776	350	105955	240	106068	350	106155	350
104434	296	104529	296	105679	206	105777	350	105956	240	106069	350	106156	350
104435	296	104554	296	105680	206	105778	350	105957	240	106070	350	106157	350
104436	296	104555	296	105681	206	105779	350	105958	240	106071	350	106158	350
104437	296	104556	296	105682	206	105780	350	105959	240	106072	350	106159	350
104438	296	104571	385	105683	206	105781	350	105960	240	106073	350	106160	350
104439	296	104572	195	105684	206	105782	350	105961	240	106074	350	106161	350
104440	296	104573	195	105685	206	105783	350	105962	240	106075	350	106162	350
104441	296	104574	195	105686	206	105784	350	105963	239	106076	350	106163	350
104442	296	104575	195	105687	206	105785	350	105964	239	106077	350	106164	350
104443	296	104576	195	105688	206	105786	350	105965	239	106078	350	106165	350
104444	296	104577	195	105689	206	105787	350	105966	238	106079	350	106166	350
104445	296	104578	195	105690	206	105788	350	105967	238	106080	350	106168	350
104446	296	104579	195	105691	206	105789	350	105968	238	106081	350	106169	350
104447	296	104791	378	105692	206	105790	350	105969	238	106082	350	106171	350
104448	296	104792	378	105693	206	105791	350	105970	238	106083	350	106172	350
104449	296	104794	239	105694	206	105792	350	105971	238	106084	350	106174	350
104450	296	104795	239	105695	206	105793	350	105972	358	106085	350	106175	350
104451	296	104796	239	105696	206	105794	350	105973	358	106086	350	106176	350
104452	296	104808	308	105697	206	105795	350	105974	358	106087	350	106177	350
104453	296	104809	308	105698	206	105796	350	105975	358	106088	350	106178	350
104454	296	104810	308	105699	206	105797	350	105976	358	106089	350	106179	447
104455	296	104811	308	105704	206	105798	350	105977	358	106090	350	106180	447
104456	296	104916	192	105705	206	105799	350	105978	358	106091	350	106181	447
104457	296	104917	194	105706	206	105800	350	105979	358	106092	350	106182	447
104458	296	104918	194	105707	206	105801	350	105980	358	106093	350	106183	447
104459	296	104919	192	105708	206	105802	350	105981	358	106094	350	106184	447
104460	296	104920	194	105709	206	105803	350	105982	358	106095	350	106186	447
104461	296	104921	194	105710	206	105804	350	105983	358	106096	350	106291	549
104462	296	105038	89	105711	206	105805	350	105984	358	106097	350	106292	549
104463	296	105041	89	105712	206	105806	350	105985	358	106098	350	106294	549
104464	296	105088	90	105713	206	105807	350	105986	358	106099	350	106295	549
104465	296	105089	90	105714	200	105808	350	105987	358	106100	350	106296	549
104466	296	105557	358	105715	200	105809	350	105988	358	106101	350	106297	549
104467	296	105562	358	105716	199	105810	350	106015	460	106102	350	106298	549
104468	296	105563	358	105717	199	105811	350	106016	460	106103	350	106299	549
104469	296	105564	358	105718	197	105812	350	106017	460	106104	350	106300	549
104470	296	105565	358	105719	197	105813	350	106018	460	106105	350	106303	549
104471	296	105567	358	105720	197	105814	350	106019	460	106106	350	106304	550
104472	296	105572	358	105721	197	105881	195	106020	460	106107	350	106305	550
104473	296	105573	358	105722	205	105882	195	106021	460	106108	350	106306	550
104474	296	105574	358	105723	205	105883	195	106022	460	106109	350	106307	550

Part Number Index

BradyID.com/s36

Catalog #	Pg	Catalog #	Pg	Catalog #	Pg	Catalog #	Pg	Catalog #	Pg	Catalog #	Pg	Catalog #	Pg
109039	352	109894	351	113188	90	116106	413	118944	194	121048	301	121202	372
109055	352	109895	351	113189	90	116107	413	118945	194	121049	301	121203	372
109056	352	109926	351	113190	90	116108	413	118946	194	121050	301	121204	372
109072	352	109937	350	113191	90	116109	413	118947	192	121051	301	121205	372
109073	352	109938	350	113192	90	116132	414	118948	192	121056	374	121206	372
109078	352	109939	350	113193	90	116133	414	118949	192	121061	375	121207	372
109124	352	109940	350	113194	90	118156	413	118950	192	121062	375	121208	372
109125	352	109941	350	113195	90	118157	413	118951	192	121063	375	121209	372
109152	351	109942	350	113196	90	118162	413	118952	192	121064	375	121210	372
109153	351	110017	302	113197	90	118163	413	118953	192	121065	376	121211	372
109154	352	110018	302	113198	90	118164	413	118954	192	121066	376	121212	372
109155	352	110019	302	113199	90	118165	413	118955	192	121067	376	121213	372
109182	352	110020	302	113200	90	118188	414	118956	192	121068	376	121214	372
109183	352	110220	99	113201	90	118189	414	118957	192	121069	376	121364	296
109199	353	110221	99	113202	90	118815	372	118958	192	121070	376	121365	296
109219	351	110235	352	113203	90	118816	372	118959	192	121071	376	121366	296
109220	351	110236	352	113204	90	118817	372	118960	192	121072	384	121367	296
109221	352	110972	526	113205	90	118821	372	118961	192	121078	384	121368	296
109222	352	110973	526	113206	90	118822	372	118962	192	121079	384	121369	296
109223	353	110975	526	113207	90	118823	372	118963	192	121080	384	121370	377
109250	351	110976	526	113208	90	118827	372	118964	192	121085	384	121371	377
109251	351	110977	526	113209	90	118828	372	118965	192	121086	384	121399	301
109252	352	110978	526	113210	90	118829	372	118966	192	121087	384	121400	301
109253	352	110979	526	113211	90	118833	372	118967	192	121088	384	121401	301
109273	351	112500	566	113212	90	118834	372	118968	192	121091	384	121402	301
109274	351	112626	562	113213	90	118835	372	118969	192	121092	384	121403	301
109275	352	112653B	483	113214	90	118839	372	118970	192	121093	384	121404	301
109276	352	112654B	483	113215	90	118840	372	118971	194	121094	384	121405	301
109308	351	112655B	483	113216	90	118841	372	118972	194	121097	384	121406	301
109309	351	112656B	483	113217	90	118845	372	118973	194	121098	384	121407	301
109310	353	113063B	483	113218	90	118846	372	118974	194	121099	384	121408	301
109326	351	113105	94	113219	90	118847	372	118975	194	121100	384	121409	301
109327	351	113106	94	113220	91	118851	372	118976	194	121101	384	121410	301
109328	353	113107	94	113221	91	118852	372	118977	194	121102	384	121411	301
109344	351	113108	94	113222	91	118853	372	118978	194	121103	384	121412	301
109345	351	113109	94	113226	91	118857	372	118979	194	121104	384	121413	300
109350	351	113110	94	113227	91	118858	372	118980	194	121117	300	121414	300
109351	351	113111	94	113228	91	118859	372	118981	194	121118	300	121415	300
109360	351	113112	94	113229	91	118863	372	118982	194	121119	300	121416	300
109361	351	113113	94	113230	91	118864	372	119752	431	121120	300	121417	300
109373	352	113114	94	113231	212	118865	372	119756	431	121121	300	121418	300
109374	352	113115	94	113232	212	118869	372	119760	431	121122	300	121419	300
109390	352	113116	94	113233	212	118870	372	119764	431	121123	300	121420	300
109391	352	113117	94	113234	212	118871	372	119768	431	121124	300	121421	300
109440	351	113118	94	113280	576	118875	372	119982	431	121125	300	121422	300
109441	351	113119	94	113303	562	118876	372	119986	431	121126	300	121431	375
109442	352	113120	94	113304	562	118877	372	119990	431	121127	300	121432	375
109443	352	113121	94	113305	562	118881	372	120645	431	121128	300	121433	375
109467	352	113122	94	113319	575	118882	372	120649	431	121129	300	121434	375
109468	352	113123	94	114533	98	118883	372	120653	431	121130	300	121435	375
109488	351	113124	94	115222	576	118887	372	120658	431	121131	300	121436	375
109489	351	113125	94	115239	576	118888	372	120847	90	121139	301	121437	375
109490	352	113126	94	115240	576	118889	372	120848	90	121140	375	121438	375
109491	352	113127	94	115250	567	118893	372	120849	90	121141	376	121439	375
109496	353	113128	94	115256	567	118894	372	120850	90	121144	375	121441	376
109527	352	113129	94	115475	574	118895	372	120851	90	121151	375	121448	196
109528	352	113130	94	115589	576	118899	372	120852	90	121152	375	121449	196
109529	353	113131	94	115751	90	118900	372	120853	90	121153	375	121466	376
109560	351	113132	94	115752	90	118901	372	120854	90	121154	375	121467	376
109561	351	113133	94	115753	90	118905	372	120855	90	121155	375	121469	376
109562	352	113134	94	115754	90	118906	372	120856	90	121156	375	121471	376
109563	352	113135	94	115755	90	118907	372	120857	90	121157	375	121473	376
109579	352	113136	94	115756	90	118911	372	120858	90	121158	375	121502	241
109580	352	113137	94	115757	90	118912	372	120859	90	121159	375	121504	210
109681	351	113138	94	115759	90	118913	372	120860	90	121161	374	121505	210
109682	351	113139	94	115760	90	118917	372	120862	90	121163	374	121506	247
109725	351	113140	94	115761	90	118918	372	120863	90	121164	374	121507	247
109726	351	113141	94	115762	90	118919	372	120864	90	121165	374	121508	244
109727	352	113142	94	115763	93	118925	192	120865	90	121183	377	121509	244
109728	352	113143	94	115764	93	118926	192	120866	90	121184	377	121510	234
109740	352	113144	94	115765	93	118927	192	120867	90	121185	377	121511	247
109741	352	113145	94	115766	93	118928	192	120994	32	121186	377	121512	244
109753	352	113146	94	115767	93	118929	192	121033	301	121187	377	121513	234
109754	352	113147	94	115768	93	118930	192	121034	301	121188	372	121514	204
109785	351	113148	94	115769	93	118931	192	121035	301	121189	372	121515	204
109786	351	113149	94	115770	93	118932	192	121036	301	121190	372	121516	204
109802	351	113150	94	115771	93	118933	192	121037	301	121191	372	121517	204
109803	351	113151	94	115772	93	118934	192	121038	301	121192	372	121518	204
109845	351	113152	94	115773	93	118935	194	121039	301	121193	372	121519	204
109846	352	113153	94	115936	413	118936	194	121040	301	121194	372	121520	204
109847	352	113154	94	115943	413	118937	194	121041	301	121195	372	121521	332
109848	352	113182	90	115944	413	118938	194	121042	301	121196	372	121522	332
109849	353	113183	90	115945	413	118939	194	121043	301	121197	372	121540	212
109865	351	113184	90	116077	477	118940	194	121044	301	121198	372	121541	212
109866	351	113185	90	116078	477	118941	194	121045	301	121199	372	121543	93
109888	351	113186	90	116100	413	118942	194	121046	301	121200	372	121544	93
109889	351	113187	90	116101	413	118943	194	121047	301	121201	372	121545	93

Part Number Index

BradyID.com/s36

Catalog #	Pg	Catalog #	Pg	Catalog #	Pg	Catalog #	Pg	Catalog #	Pg	Catalog #	Pg	Catalog #	Pg
121759	398	121846	398	122245	209	122361	494	122466	490	122573	426	122677	557
121760	398	121847	398	122246	209	122362	494	122467	491	122574	430	122678	513
121761	398	121848	398	122247	209	122363	555	122468	526	122575	422	122679	419
121762	398	121849	398	122248	209	122364	557	122469	461	122576	506	122680	419
121763	398	121850	398	122249	209	122365	521	122470	418	122577	509	122681	557
121764	398	121851	398	122250	209	122366	521	122471	490	122578	543	122682	556
121765	398	121852	398	122252	209	122367	557	122473	494	122579	474	122683	557
121766	398	121853	398	122253	209	122368	557	122474	520	122580	474	122684	556
121767	398	121854	398	122254	209	122369	557	122475	495	122581	555	122685	556
121768	398	121855	398	122255	209	122370	419	122476	474	122582	555	122688	489
121769	398	121856	398	122256	209	122371	557	122477	472	122583	556	122689	422
121770	398	121857	398	122258	209	122372	556	122479	472	122584	555	122691	568
121771	398	121858	398	122260	209	122373	557	122480	555	122585	487	122692	530
121772	398	121859	398	122261	209	122374	556	122481	487	122586	494	122694	495
121773	398	121860	398	122262	209	122375	556	122482	494	122587	494	122695	469
121774	398	121861	398	122263	209	122377	489	122483	494	122588	494	122697	417
121775	398	121862	398	122264	209	122379	568	122484	507	122589	507	122702	489
121776	398	121863	398	122265	209	122382	495	122485	419	122590	505	122703	526
121777	398	121864	398	122267	332	122383	533	122486	556	122594	555	122705	476
121778	398	121865	398	122268	332	122384	527	122487	556	122595	557	122706	490
121779	398	121866	398	122269	332	122385	417	122488	556	122596	521	122707	491
121780	398	121867	398	122270	332	122387	451	122489	460	122597	521	122708	418
121781	398	121868	398	122271	332	122391	435	122491	489	122598	557	122709	418
121782	398	121869	398	122272	332	122392	489	122493	568	122599	557	122710	490
121783	398	121870	398	122273	332	122394	461	122495	495	122600	557	122712	443
121784	398	121871	398	122274	332	122395	505	122496	527	122601	513	122713	454
121785	398	121872	398	122275	332	122396	443	122497	417	122602	419	122714	413
121786	398	121873	398	122276	332	122397	439	122499	451	122603	557	122715	430
121787	398	121874	398	122277	332	122398	436	122503	473	122604	556	122716	506
121788	398	121875	398	122278	332	122399	435	122505	461	122605	557	122717	542
121789	398	121876	398	122279	332	122400	435	122506	505	122606	556	122718	509
121790	398	121877	398	122280	332	122401	434	122507	443	122607	556	122719	543
121791	398	121878	398	122281	332	122402	442	122508	439	122608	460	122720	494
121792	398	121879	398	122282	332	122403	440	122509	436	122610	489	122721	520
121793	398	121880	398	122283	332	122404	441	122510	435	122611	421	122722	494
121794	398	121881	398	122284	332	122405	467	122511	435	122612	432	122723	474
121795	398	121882	398	122285	332	122406	451	122512	434	122614	568	122724	472
121796	398	121883	398	122286	332	122407	452	122513	442	122616	530	122725	474
121797	398	121884	398	122287	332	122408	531	122514	440	122618	495	122726	472
121798	398	121885	398	122288	332	122409	507	122515	441	122619	469	122727	555
121799	398	121886	398	122289	332	122410	532	122516	467	122620	417	122728	555
121800	398	121887	398	122290	332	122411	509	122517	452	122622	521	122729	556
121801	398	121888	398	122291	332	122412	416	122518	450	122626	490	122730	555
121802	398	121889	398	122292	332	122413	417	122519	453	122627	490	122731	487
121803	398	121890	398	122293	332	122414	417	122520	531	122628	504	122732	494
121804	398	121891	398	122294	332	122415	560	122521	509	122629	505	122733	494
121805	398	121892	398	122295	332	122416	519	122522	543	122631	442	122734	494
121806	398	121893	398	122296	332	122417	520	122523	560	122632	489	122735	507
121807	398	121894	398	122297	332	122418	474	122524	519	122634	477	122736	555
121808	398	121895	398	122298	332	122419	472	122525	417	122635	476	122737	557
121809	398	121896	398	122299	332	122421	472	122526	538	122636	477	122738	521
121810	398	121897	398	122300	332	122422	555	122527	474	122637	461	122739	521
121811	398	121898	398	122301	332	122423	555	122528	472	122638	505	122740	557
121812	398	121899	398	122302	332	122424	556	122530	472	122639	418	122741	557
121813	398	121900	398	122303	332	122425	555	122531	555	122640	443	122742	557
121814	398	121901	398	122304	332	122426	487	122532	555	122641	439	122743	513
121815	398	121902	398	122305	332	122427	494	122534	555	122642	436	122744	419
121816	398	121903	398	122306	332	122428	494	122535	487	122643	435	122745	557
121817	398	121904	398	122307	332	122429	488	122536	494	122644	435	122746	556
121818	398	121905	398	122308	332	122430	507	122537	494	122645	434	122747	557
121819	398	121906	398	122309	332	122431	555	122538	488	122646	442	122748	556
121820	398	121907	398	122310	332	122432	557	122539	507	122647	440	122749	556
121821	398	121908	398	122311	332	122433	521	122540	555	122648	441	122750	460
121822	398	121909	398	122312	332	122434	521	122541	557	122649	467	122752	489
121823	398	121910	398	122313	332	122435	557	122542	521	122650	451	122753	432
121824	398	121911	398	122314	332	122436	557	122543	521	122651	486	122754	422
121825	398	121912	398	122337	489	122437	557	122544	557	122652	509	122756	414
121826	398	121913	295	122338	476	122438	513	122545	557	122653	543	122757	476
121827	398	121914	295	122339	490	122439	419	122546	557	122654	415	122758	441
121828	398	121915	295	122340	490	122440	557	122547	513	122655	519	122760	449
121829	398	121916	295	122341	491	122441	556	122548	419	122656	474	122762	530
121830	398	121917	295	122342	526	122442	557	122549	557	122658	555	122764	495
121831	398	121918	295	122343	461	122443	556	122550	556	122659	555	122765	469
121832	398	122048	332	122344	418	122444	556	122551	557	122660	556	122766	471
121833	398	122049	332	122345	490	122447	568	122552	556	122661	555	122767	533
121834	398	122050	332	122347	443	122449	530	122553	556	122662	494	122768	417
121835	398	122051	332	122349	494	122451	495	122554	460	122663	494	122770	451
121836	398	122052	332	122350	520	122452	469	122557	530	122664	494	122774	490
121837	398	122053	332	122351	495	122453	471	122559	469	122665	488	122775	490
121838	398	122054	332	122352	474	122454	421	122560	417	122666	507	122776	504
121839	398	122055	332	122353	472	122455	533	122562	451	122667	505	122777	542
121840	398	122056	332	122355	472	122456	417	122565	476	122671	555	122778	505
121841	398	122057	332	122356	555	122458	451	122566	490	122672	557	122779	439
121842	398	122241	209	122357	555	122459	521	122567	491	122673	521	122780	436
121843	398	122242	209	122358	556	122463	489	122568	418	122674	521	122781	435
121844	398	122243	209	122359	555	122464	476	122569	418	122675	557	122782	435
121845	398	122244	209	122360	487	122465	490	122570	490	122676	557	122783	434

Part Number Index

BradyID.com/s36

Catalog #	Pg	Catalog #	Pg	Catalog #	Pg	Catalog #	Pg	Catalog #	Pg	Catalog #	Pg	Catalog #	Pg
122874	507	123281	194	123404	193	123506	418	123599	555	123686	513	123779	489
122875	555	123282	194	123405	193	123507	418	123600	555	123687	513	123780	489
122876	557	123283	194	123406	193	123508	418	123601	555	123688	513	123781	489
122877	521	123284	195	123407	193	123509	418	123602	555	123689	452	123782	489
122878	521	123285	195	123408	193	123510	418	123603	555	123690	452	123783	489
122879	557	123286	195	123409	193	123511	418	123604	555	123691	452	123784	489
122880	557	123287	195	123410	193	123512	418	123605	468	123692	452	123785	476
122881	557	123288	195	123411	193	123513	418	123606	468	123693	452	123786	476
122882	513	123289	195	123412	193	123514	544	123607	468	123694	452	123787	476
122883	419	123290	195	123413	193	123515	544	123608	468	123695	473	123788	476
122884	419	123291	195	123414	193	123516	544	123609	468	123696	473	123789	476
122885	557	123292	195	123415	193	123517	544	123610	468	123697	473	123790	476
122886	556	123293	195	123416	193	123518	544	123611	474	123698	473	123791	479
122887	557	123294	195	123417	193	123519	544	123612	474	123699	473	123792	479
122888	556	123295	195	123418	193	123520	557	123613	474	123700	473	123793	479
122889	556	123296	195	123419	193	123521	557	123614	474	123701	414	123794	479
122890	460	123297	195	123420	193	123522	557	123615	474	123702	414	123795	479
122892	489	123298	195	123421	193	123523	557	123616	474	123703	414	123796	479
122894	414	123299	195	123422	193	123524	557	123617	413	123704	414	123797	479
122895	457	123300	195	123423	193	123525	557	123618	413	123705	414	123798	479
122897	568	123301	195	123424	193	123526	555	123619	413	123706	414	123799	479
122898	449	123302	195	123425	193	123527	555	123620	413	123707	452	123800	479
122900	530	123303	195	123426	193	123528	555	123621	413	123708	452	123801	479
122902	495	123304	195	123427	193	123529	555	123622	413	123709	452	123802	479
122903	469	123305	195	123428	193	123530	555	123623	468	123710	452	123803	476
122904	471	123306	195	123429	193	123531	555	123624	468	123711	452	123804	476
122905	421	123307	195	123430	193	123532	557	123625	468	123712	452	123805	476
122906	527	123308	195	123431	193	123533	557	123626	468	123713	466	123806	476
122907	417	123309	195	123432	195	123534	557	123627	468	123714	466	123807	476
122909	451	123310	195	123433	195	123535	557	123628	468	123715	466	123808	476
122910	416	123311	195	123434	195	123536	557	123629	452	123716	466	123809	475
122911	494	123312	195	123435	195	123537	557	123630	452	123717	466	123810	475
122914	441	123313	195	123436	195	123538	471	123631	452	123718	466	123811	475
123048	526	123314	195	123437	195	123539	521	123632	452	123719	414	123812	475
123049	526	123315	195	123438	195	123540	521	123633	452	123720	414	123813	475
123050	526	123316	195	123439	195	123541	521	123634	452	123721	414	123814	475
123051	526	123317	195	123440	195	123542	521	123635	505	123722	414	123815	471
123052	526	123318	195	123441	195	123543	521	123636	505	123723	414	123816	471
123053	526	123319	195	123442	418	123544	521	123637	505	123724	414	123817	471
123054	526	123320	195	123443	418	123545	521	123638	505	123725	511	123818	471
123055	526	123321	195	123444	418	123546	521	123639	505	123726	511	123819	471
123143	193	123322	195	123445	418	123547	521	123640	505	123727	511	123820	471
123236	194	123323	195	123446	418	123548	521	123641	467	123728	511	123821	540
123237	194	123324	193	123447	418	123549	521	123642	467	123729	511	123822	540
123238	194	123325	193	123448	419	123550	521	123643	467	123730	511	123823	540
123239	194	123326	193	123449	419	123551	418	123644	467	123731	512	123824	540
123240	194	123327	193	123450	419	123552	418	123645	467	123732	512	123825	540
123241	194	123328	193	123451	419	123553	418	123646	467	123733	512	123826	540
123242	194	123329	193	123452	419	123554	418	123647	467	123734	512	123827	538
123243	194	123330	193	123453	419	123555	418	123648	467	123735	512	123828	538
123244	194	123331	193	123454	419	123556	418	123649	467	123736	512	123829	538
123245	194	123332	193	123455	419	123557	544	123650	467	123737	512	123830	538
123246	194	123333	193	123456	419	123558	544	123651	467	123738	512	123831	538
123247	194	123334	193	123457	419	123559	544	123652	467	123739	512	123832	538
123248	194	123335	193	123458	419	123560	544	123653	455	123740	512	123833	517
123249	194	123336	193	123459	419	123561	544	123654	455	123741	512	123834	517
123250	194	123337	193	123460	417	123562	544	123655	455	123742	512	123835	517
123251	194	123338	193	123461	417	123563	514	123656	455	123743	495	123836	517
123252	194	123339	193	123462	417	123564	514	123657	455	123744	495	123837	517
123253	194	123340	193	123463	417	123565	514	123658	455	123745	495	123838	517
123254	194	123341	193	123464	417	123566	514	123659	450	123746	495	123839	517
123255	194	123342	193	123465	417	123567	514	123660	450	123747	495	123840	517
123256	194	123343	193	123466	557	123568	514	123661	450	123748	495	123841	517
123257	194	123344	193	123467	557	123569	537	123662	450	123749	489	123842	517
123258	194	123345	193	123468	557	123570	537	123663	450	123750	489	123843	517
123259	194	123346	193	123469	557	123571	537	123664	450	123751	489	123844	517
123260	194	123347	193	123470	557	123572	537	123665	454	123752	489	123845	517
123261	194	123348	193	123471	557	123573	537	123666	454	123753	489	123846	517
123262	194	123349	193	123472	557	123574	537	123667	454	123754	489	123847	517
123263	194	123350	193	123473	557	123575	536	123668	454	123755	489	123848	517
123264	194	123351	193	123474	419	123576	536	123669	454	123756	489	123849	517
123265	194	123352	193	123475	419	123577	536	123670	454	123757	489	123850	517
123266	194	123353	193	123476	419	123578	536	123671	467	123758	489	123851	516
123267	194	123354	193	123477	419	123579	536	123672	467	123759	489	123852	516
123268	192	123355	193	123478	419	123580	536	123673	467	123760	489	123853	516
123269	192	123356	193	123479	419	123581	555	123674	467	123761	489	123854	516
123270	192	123357	193	123480	471	123582	555	123675	467	123762	489	123855	516
123271	192	123358	193	123481	419	123583	555	123676	467	123763	489	123856	516
123272	194	123359	193	123482	419	123584	555	123677	535	123764	489	123857	460
123273	194	123360	193	123483	419	123585	555	123678	535	123765	489	123858	460
123274	194	123361	193	123484	419	123586	555	123679	535	123766	489	123859	460
123275	194	123362	193	123485	419	123587	555	123680	535	123767	488	123860	460
123276	194	123363	193	123486	419	123588	555	123681	535	123768	488	123861	460
123277	194	123364	193	123487	418	123589	555	123682	535	123769	488	123862	460
123278	194	123365	193	123488	418	123590	555	123683	513	123770	488	123863	517
123279	194	123366	193	123489	418	123591	555	123684	513	123771	488	123864	517
123280	194	123367	193	123490	418	123592	555	123685	513	123772	488	123865	517

Part Number Index

BradyID.com/s36

Catalog #	Pg	Catalog #	Pg	Catalog #	Pg	Catalog #	Pg	Catalog #	Pg	Catalog #	Pg	Catalog #	Pg	Catalog #	Pg
123953	516	124042	440	124133	442	124220	506	124307	563	124400	576	124487	576	124574	444
123954	516	124043	439	124134	442	124221	506	124308	562	124401	574	124488	576	124575	562
123955	516	124044	439	124135	442	124222	506	124309	562	124402	574	124489	576	124576	562
123958	516	124045	439	124136	442	124223	529	124310	562	124403	574	124490	576	124577	562
123959	544	124046	439	124137	442	124224	529	124311	563	124404	574	124491	572	124578	562
123960	544	124047	439	124138	442	124225	529	124312	563	124405	574	124492	572	124579	573
123961	544	124048	439	124139	437	124226	529	124313	563	124406	574	124493	572	124580	573
123962	544	124049	434	124140	437	124227	529	124314	564	124407	575	124494	572	124581	573
123963	544	124050	434	124141	437	124228	529	124315	564	124408	575	124495	572	124582	573
123964	544	124051	434	124142	437	124229	542	124316	564	124409	575	124496	572	124583	576
123965	544	124052	434	124143	437	124230	542	124317	562	124410	574	124497	572	124584	576
123966	544	124053	434	124144	437	124231	542	124318	562	124411	574	124498	572	124585	576
123967	544	124054	434	124145	439	124232	542	124319	562	124412	574	124499	572	124586	576
123968	544	124055	434	124146	439	124233	542	124320	562	124413	574	124500	572	124587	577
123969	544	124056	434	124147	439	124234	542	124321	562	124414	574	124501	572	124588	577
123970	544	124057	434	124148	439	124235	466	124322	562	124415	574	124502	572	124589	577
123971	545	124058	434	124149	439	124236	466	124323	562	124416	577	124503	561	124590	577
123972	545	124059	434	124150	439	124237	466	124324	562	124417	577	124504	561	124591	573
123973	545	124060	434	124151	443	124238	466	124325	562	124418	577	124505	561	124592	573
123974	545	124061	437	124152	443	124239	466	124326	561	124419	576	124506	572	124593	573
123975	545	124062	437	124153	443	124240	466	124327	561	124420	576	124507	572	124594	573
123976	545	124063	437	124154	443	124241	507	124328	561	124421	576	124508	572	124595	574
123977	545	124064	437	124155	443	124242	507	124329	564	124422	576	124509	572	124596	574
123978	545	124065	437	124156	443	124243	507	124330	564	124423	576	124510	572	124597	574
123979	545	124066	437	124157	443	124244	507	124331	564	124424	576	124511	572	124598	574
123980	545	124071	437	124158	443	124245	507	124332	562	124425	574	124512	572	124599	577
123981	545	124072	437	124159	443	124246	507	124333	562	124426	574	124513	572	124600	577
123982	545	124073	438	124160	443	124247	531	124334	562	124427	574	124514	572	124601	577
123983	545	124074	438	124161	443	124248	531	124335	563	124428	572	124515	572	124602	577
123984	545	124075	438	124162	443	124249	531	124336	563	124429	572	124516	572	124603	577
123985	545	124076	438	124163	442	124250	531	124337	563	124430	572	124517	572	124604	577
123986	545	124077	438	124164	442	124251	531	124338	560	124431	576	124518	572	124605	577
123987	545	124078	438	124165	442	124252	531	124339	560	124432	576	124519	572	124606	577
123988	545	124079	437	124166	442	124253	533	124340	560	124433	576	124520	572	124607	574
123989	442	124080	437	124167	442	124254	533	124341	564	124434	576	124521	572	124608	574
123990	442	124081	437	124168	442	124255	533	124342	564	124435	576	124522	572	124609	574
123991	442	124082	437	124169	443	124256	533	124343	564	124436	576	124523	572	124610	574
123992	442	124083	437	124170	443	124257	533	124344	561	124437	572	124524	572	124611	572
123993	442	124084	437	124171	443	124258	533	124345	561	124438	572	124525	572	124612	572
123994	442	124085	436	124172	443	124259	530	124346	561	124439	572	124526	540	124613	572
123995	434	124086	436	124173	443	124260	530	124347	561	124440	575	124527	540	124614	572
123996	434	124087	436	124174	443	124261	530	124348	561	124441	575	124528	540	124615	572
123997	434	124088	436	124175	444	124262	530	124349	561	124442	575	124529	540	124616	572
123998	434	124089	436	124176	444	124263	530	124350	561	124443	577	124530	572	124617	572
123999	434	124090	436	124177	444	124264	530	124351	561	124444	577	124531	572	124618	572
124000	434	124091	437	124178	444	124265	466	124352	561	124445	577	124532	572	124619	576
124001	442	124092	437	124179	444	124266	466	124353	573	124446	576	124533	572	124620	576
124002	442	124093	437	124180	444	124267	466	124354	573	124447	576	124534	572	124621	576
124003	442	124094	437	124181	542	124268	466	124355	573	124448	576	124535	572	124622	539
124004	442	124095	437	124182	542	124269	466	124356	561	124449	572	124536	572	124623	539
124005	442	124096	437	124183	542	124270	466	124357	561	124450	572	124537	572	124624	539
124006	442	124097	436	124184	542	124271	573	124358	561	124451	572	124538	540	124625	471
124007	440	124098	436	124185	542	124272	573	124359	563	124452	577	124539	540	124626	471
124008	440	124099	436	124186	542	124273	573	124360	563	124453	577	124540	540	124627	471
124009	440	124100	436	124187	570	124274	506	124361	563	124454	577	124541	540	124628	471
124010	440	124101	436	124188	570	124275	506	124362	564	124455	575	124542	540	124629	471
124011	440	124102	436	124189	570	124276	506	124363	564	124456	575	124543	540	124630	471
124012	440	124103	437	124190	570	124277	506	124364	564	124457	575	124544	540	124631	544
124013	437	124104	437	124191	570	124278	506	124371	564	124458	574	124545	540	124632	544
124014	437	124105	437	124192	570	124279	506	124372	564	124459	574	124546	572	124633	544
124015	437	124106	437	124193	570	124280	449	124373	564	124460	574	124547	572	124634	545
124016	437	124107	437	124194	570	124281	449	124374	564	124461	573	124548	572	124635	545
124017	437	124108	437	124195	570	124282	449	124375	564	124462	573	124549	572	124636	545
124018	437	124109	444	124196	570	124283	449	124376	564	124463	573	124550	540	124637	545
124019	443	124110	444	124197	570	124284	449	124377	562	124464	575	124551	540	124638	545
124020	443	124111	444	124198	570	124285	449	124378	562	124465	575	124552	540	124639	545
124021	443	124112	444	124199	573	124286	466	124379	562	124466	575	124553	540	124640	526
124022	443	124113	444	124200	573	124287	466	124380	562	124467	577	124554	572	124641	526
124023	443	124114	444	124201	573	124288	466	124381	562	124468	577	124555	572	124642	526
124024	443	124115	439	124202	573	124289	466	124382	562	124469	577	124556	572	124643	444
124025	442	124116	439	124203	573	124290	466	124383	564	124470	577	124557	572	124644	444
124026	442	124117	439	124204	573	124291	466	124384	564	124471	577	124558	572	124645	444
124027	442	124118	439	124205	570	124292	530	124385	564	124472	577	124559	572	124646	444
124028	442	124119	439	124206	570	124293	530	124386	560	124473	575	124560	572	124647	412
124029	442	124120	439	124207	570	124294	530	124387	560	124474	575	124561	572	124648	412
124030	442	124121	438	124208	570	124295	530	124388	560	124475	575	124562	442	124649	412
124031	440	124122	438	124209	570	124296	530	124389	563	124476	577	124563	442	124650	412
124032	440	124123	438												

Part Number Index

BradyID.com/s36

Catalog #	Pg	Catalog #	Pg	Catalog #	Pg	Catalog #	Pg	Catalog #	Pg	Catalog #	Pg	Catalog #	Pg
128870	536	128957	538	129044	530	129131	515	129218	543	129305	542	129393	544
128871	536	128958	538	129045	530	129132	538	129219	543	129306	542	129394	544
128872	536	128959	538	129046	530	129133	538	129220	543	129307	542	129395	544
128873	536	128960	538	129047	530	129134	538	129221	543	129308	542	129396	544
128874	536	128961	538	129048	530	129135	538	129222	543	129309	542	129397	544
128875	536	128962	538	129049	530	129136	538	129223	543	129310	542	129398	544
128876	536	128963	538	129050	530	129137	538	129224	543	129311	542	129399	545
128877	536	128964	538	129051	530	129138	516	129225	543	129312	542	129400	545
128878	536	128965	538	129052	530	129139	516	129226	543	129313	542	129401	545
128879	536	128966	538	129053	530	129140	516	129227	543	129314	542	129402	545
128880	536	128967	538	129054	507	129141	516	129228	541	129315	542	129403	545
128881	536	128968	538	129055	507	129142	516	129229	541	129317	542	129404	545
128882	536	128969	538	129056	507	129143	516	129230	541	129318	542	129405	555
128883	536	128970	538	129057	507	129144	516	129231	541	129319	542	129406	555
128884	536	128971	538	129058	507	129145	516	129232	541	129320	542	129407	555
128885	536	128972	538	129059	507	129146	516	129233	541	129321	542	129408	555
128886	536	128973	538	129060	507	129147	516	129234	541	129322	542	129409	555
128887	536	128974	538	129061	507	129148	516	129235	541	129323	542	129410	555
128888	536	128975	538	129062	507	129149	516	129236	541	129324	542	129411	557
128889	536	128976	538	129063	507	129150	517	129237	541	129325	542	129412	557
128890	536	128977	538	129064	507	129151	517	129238	541	129326	542	129413	557
128891	536	128978	538	129065	507	129152	517	129239	541	129327	542	129414	557
128892	537	128979	538	129066	508	129153	517	129240	541	129328	542	129415	557
128893	537	128980	538	129067	508	129154	517	129241	541	129329	542	129416	557
128894	537	128981	538	129068	508	129155	517	129242	541	129330	542	129417	557
128895	537	128982	538	129069	508	129156	541	129243	541	129331	542	129418	557
128896	537	128983	538	129070	508	129157	541	129244	541	129332	542	129419	557
128897	537	128984	538	129071	508	129158	541	129245	541	129333	542	129420	557
128898	537	128985	538	129072	508	129159	541	129246	541	129334	542	129421	557
128899	537	128986	538	129073	508	129160	541	129247	541	129335	542	129422	557
128900	537	128987	538	129074	508	129161	541	129248	541	129336	542	129423	576
128901	537	128988	538	129075	508	129162	541	129249	541	129337	542	129424	576
128902	537	128989	538	129076	508	129163	541	129250	541	129338	542	129425	576
128903	537	128990	538	129077	508	129164	541	129251	541	129339	542	129426	573
128904	537	128991	538	129078	509	129165	541	129252	541	129340	542	129427	573
128905	537	128992	538	129079	509	129166	541	129253	541	129341	542	129428	573
128906	537	128993	538	129080	509	129167	541	129254	541	129342	543	129429	573
128907	537	128994	538	129081	509	129168	531	129255	541	129343	543	129430	573
128908	537	128995	538	129082	509	129169	531	129256	541	129344	543	129431	573
128909	537	128996	538	129083	509	129170	531	129257	541	129345	544	129432	575
128910	537	128997	538	129084	507	129171	531	129258	541	129346	544	129433	575
128911	537	128998	538	129085	507	129172	531	129259	541	129347	544	129434	575
128912	537	128999	538	129086	507	129173	531	129260	541	129348	544	129435	574
128913	537	129000	538	129087	507	129174	541	129261	541	129349	544	129436	574
128914	537	129001	538	129088	507	129175	541	129262	541	129350	544	129437	574
128915	537	129002	538	129089	507	129176	541	129263	541	129351	544	129438	575
128916	537	129003	538	129090	509	129177	541	129264	541	129352	544	129439	575
128917	537	129004	538	129091	509	129178	541	129265	541	129353	544	129440	575
128918	537	129005	538	129092	509	129179	541	129266	541	129354	544	129441	575
128919	537	129006	538	129093	509	129180	541	129267	541	129355	544	129442	575
128920	537	129007	538	129094	509	129181	541	129268	541	129356	544	129443	575
128921	537	129008	538	129095	509	129182	541	129269	541	129357	544	129444	575
128922	537	129009	538	129096	534	129183	541	129270	542	129358	544	129445	575
128923	537	129010	538	129097	534	129184	541	129271	542	129359	544	129446	575
128924	537	129011	538	129098	534	129185	541	129272	542	129360	544	129447	577
128925	537	129012	538	129099	534	129186	541	129273	542	129361	544	129448	577
128926	537	129013	538	129100	534	129187	541	129274	542	129362	544	129449	577
128927	537	129014	538	129101	534	129188	541	129275	542	129363	544	129450	573
128928	537	129015	538	129102	534	129189	541	129276	541	129364	544	129451	573
128929	537	129016	538	129103	534	129190	541	129277	541	129365	544	129452	573
128930	537	129017	538	129104	534	129191	541	129278	541	129366	544	129453	571
128931	537	129018	538	129105	534	129192	418	129279	541	129367	544	129454	571
128932	537	129019	538	129106	534	129193	418	129280	541	129368	544	129455	571
128933	537	129020	538	129107	534	129194	418	129281	541	129369	544	129456	571
128934	537	129021	538	129108	514	129195	418	129282	542	129370	544	129457	571
128935	537	129022	538	129109	514	129196	418	129283	542	129371	544	129458	571
128936	537	129023	538	129110	514	129197	418	129284	542	129372	544	129459	576
128937	537	129024	433	129111	514	129198	543	129285	542	129373	544	129460	576
128938	537	129025	433	129112	514	129199	543	129286	542	129374	544	129461	576
128939	537	129026	433	129113	514	129200	543	129287	542	129375	544	129462	574
128940	537	129027	433	129114	515	129201	543	129288	542	129376	544	129463	574
128941	537	129028	433	129115	515	129202	543	129289	542	129377	544	129464	574
128942	537	129029	433	129116	515	129203	543	129290	542	129378	544	129465	577
128943	537	129030	529	129117	515	129204	543	129291	542	129379	544	129466	577
128944	537	129031	529	129118	515	129205	543	129292	542	129380	544	129467	577
128945	537	129032	529	129119	515	129206	543	129293	542	129381	544	129468	573
128946	536	129033	529	129120	515	129207	543	129294	542	129382	544	129469	573
128947	536	129034	529	129121	515	129208	543	129295	542	129383	544	129470	573
128948	536	129035	529	129122	515	129209	543	129296	542	129384	544	129471	574
128949	536	129036	529	129123	515	129210	543	129297	542	129385	544	129472	574
128950	536	129037	529	129124	515	129211	543	129298	542	129386	544	129473	574
128951	536	129038	529	129125	515	129212	543	129299	542	129387	544	129474	574
128952	538	129039	529	129126	515	129213	543	129300	542	129388	544	129475	574
128953	538	129040	529	129127	515	129214	543	129301	542	129389	544	129476	574
128954	538	129041	529	129128	515	129215	543	129302	542	129390	544	129477	573
128955	538	129042	530	129129	515	129216	543	129303	542	129391	544	129478	573
128956	538	129043	530	129130	515	129217	543	129304	542	129392	544	129479	573

Part Number Index

BradyID.com/s36

Catalog #	Pg	Catalog #	Pg	Catalog #	Pg	Catalog #	Pg	Catalog #	Pg	Catalog #	Pg	Catalog #	Pg	Catalog #	Pg
129567	560	129659	563	129745	563	131630	413	131719	414	131811	451	131916	533	132002	522
129568	560	129660	563	129746	563	131631	413	131720	414	131812	451	131917	533	132003	522
129569	560	129661	563	129747	563	131632	413	131721	414	131813	451	131918	533	132004	522
129570	561	129662	563	129748	563	131633	413	131722	414	131814	451	131919	533	132005	527
129571	561	129663	564	129749	563	131634	413	131723	474	131815	451	131920	533	132006	527
129572	561	129664	564	129750	564	131635	413	131729	474	131816	451	131921	531	132007	527
129576	573	129665	564	129751	564	131636	413	131731	523	131817	451	131922	531	132008	527
129577	573	129666	564	129752	564	131637	413	131732	523	131818	451	131923	531	132009	527
129578	573	129667	564	129753	564	131638	413	131733	523	131819	450	131924	531	132010	527
129579	574	129668	564	129754	564	131639	413	131734	523	131820	450	131925	531	132011	527
129580	574	129669	574	129755	564	131640	413	131735	523	131821	450	131926	531	132012	527
129581	574	129670	574	140886	80	131641	413	131736	523	131822	450	131927	530	132020	556
129582	574	129671	574	130749	80	131642	413	131737	523	131823	450	131928	530	132021	556
129583	574	129672	561	130750	80	131643	413	131738	523	131824	450	131929	530	132022	556
129584	574	129673	561	140887	80	131644	413	131739	455	131825	450	131930	530	132023	556
129585	561	129674	561	130752	80	131645	413	131740	455	131826	450	131931	530	132024	556
129586	561	129675	561	130753	80	131646	413	131741	455	131829	451	131932	530	132025	556
129587	561	129676	561	140888	80	131647	414	131742	455	131830	455	131933	530	132026	556
129588	574	129677	561	130755	80	131648	414	131743	455	131831	454	131934	530	132027	521
129589	574	129678	575	130756	80	131649	414	131744	455	131832	454	131935	531	132028	521
129590	574	129679	575	140889	80	131650	414	131745	455	131833	454	131936	531	132029	521
129594	563	129680	575	130758	80	131651	414	131746	455	131834	454	131937	531	132030	521
129595	563	129681	563	130759	80	131652	414	131747	451	131835	454	131938	531	132031	521
129596	563	129682	563	140885	80	131653	414	131748	451	131836	454	131939	531	132032	521
129597	575	129683	563	130761	80	131654	414	131749	451	131837	454	131940	531	132033	521
129598	575	129684	562	130762	80	131655	414	131750	451	131838	454	131941	531	132034	521
129599	575	129685	562	140890	80	131656	414	131751	451	131839	454	131942	531	132035	521
129600	563	129686	562	130764	80	131657	414	131752	451	131840	454	131943	529	132036	521
129601	563	129687	562	130765	80	131658	414	131753	451	131841	454	131944	529	132037	521
129602	563	129688	562	130766	80	131659	414	131754	451	131842	454	131945	529	132038	521
129603	564	129689	562	130767	80	131660	414	131755	453	131843	454	131946	529	132039	521
129604	564	129690	562	130768	80	131661	414	131756	453	131844	454	131947	529	132040	521
129605	564	129691	562	130769	80	131662	414	131757	453	131845	454	131948	529	132041	555
129606	564	129692	562	130770	80	131663	415	131758	453	131846	454	131949	529	132042	555
129607	564	129693	563	130771	80	131664	415	131759	453	131853	454	131950	529	132043	555
129608	564	129694	563	130772	80	131665	415	131760	453	131854	454	131951	532	132044	555
129609	564	129695	563	130773	80	131666	415	131761	453	131859	450	131952	532	132045	555
129610	564	129696	562	130774	80	131667	415	131762	453	131861	450	131953	532	132046	555
129611	564	129697	562	130775	80	131668	415	131763	453	131862	450	131954	532	132047	555
129612	564	129698	562	130776	80	131669	415	131764	453	131863	513	131955	532	132048	555
129613	564	129699	563	130777	80	131670	415	131765	453	131864	513	131956	532	132049	571
129614	564	129700	563	130808	82	131671	415	131766	453	131865	513	131957	532	132050	571
129615	561	129701	563	130809	82	131672	415	131767	453	131866	513	131958	532	132051	571
129616	561	129702	564	130810	82	131673	415	131768	453	131867	513	131959	532	132052	571
129617	561	129703	564	130811	82	131674	415	131769	453	131868	513	131960	532	132053	571
129618	561	129704	564	130812	82	131675	415	131770	453	131869	513	131961	532	132054	571
129619	561	129705	563	130819	226	131676	415	131771	452	131870	513	131962	532	132055	571
129620	561	129706	563	130820	226	131677	415	131772	452	131871	511	131963	532	132056	571
129621	561	129707	563	130821	226	131678	415	131773	452	131872	511	131964	532	132057	414
129622	561	129708	563	130822	226	131679	466	131774	452	131873	511	131965	532	132058	470
129623	561	129709	563	130823	226	131680	466	131775	452	131874	511	131966	532	132059	470
129624	562	129710	563	130824	226	131681	466	131776	452	131875	511	131967	532	132060	508
129625	562	129711	560	131047	347	131682	466	131777	452	131876	511	131968	532	132061	508
129626	562	129712	560	131048	346	131683	466	131778	452	131877	511	131969	532	132062	508
129627	563	129713	560	131049	347	131685	466	131779	523	131878	511	131970	532	132063	508
129628	563	129714	561	131050	347	131686	466	131780	523	131879	456	131971	532	132064	508
129629	563	129715	561	131051	347	131687	468	131781	523	131880	456	131972	532	132065	508
129630	563	129716	561	131052	347	131688	468	131782	523	131881	456	131973	532	132066	508
129631	563	129717	561	131053	346	131689	468	131783	523	131882	456	131974	532	132067	508
129632	563	129718	561	131054	347	131690	468	131784	523	131883	456	131975	532	132068	508
129633	563	129719	561	131055	347	131691	468	131785	523	131884	456	131976	532	132069	508
129634	563	129720	561	131056	347	131692	468	131786	523	131885	456	131977	532	132070	508
129635	563	129721	561	131057	357	131693	468	131787	452	131886	456	131978	532	132071	508
129636	563	129722	561	131058	356	131694	468	131788	452	131887	459	131979	532	132072	508
129637	563	129723	561	131059	357	131697	473	131789	452	131888	459	131980	532	132073	508
129638	563	129724	561	131060	357	131698	473	131790	452	131889	459	131981	532	132074	508
129639	563	129725	561	131061	357	131699	473	131791	452	131890	459	131982	532	132075	508
129640	563	129726	564	131063	209	131700	473	131792	452	131891	459	131983	532	132076	506
129641	563	129727	564	131064	209	131701	473	131793	452	131892	459	131984	532	132077	506
129642	560	129728	564	131065	209	131702	473	131794	452	131893	459	131985	532	132078	506
129643	560	129729	564	131066	209	131703	473	131795	452	131894	459	131986	532	132079	506
129644	560	129730	564	131615	413	131704	473	131796	452	131895	458	131987	532	132080	506
129645	560	129731	564	131616	413	131705	473	131797	452	131896	458	131988	532	132081	506
129646	560	129732	562	131617	413	131706	473	131798	452	131897	458	131989	532	132082	506
129647	560	129733	562	131618	413	131707	473	131799	452	131898	458	131990	532	132083	506
129648	560	129734	562	131619	413	131708	473	131800	452	131899	458	131991	532	132084	507
129649	560	129735	563	131620	413	131709	473	131801	452	131900	458	131992	532	132085	507
129650	560	129736	563	131621	413	131710	473</								

Part Number Index

BradyID.com/s36

Catalog #	Pg	Catalog #	Pg	Catalog #	Pg	Catalog #	Pg	Catalog #	Pg	Catalog #	Pg	Catalog #	Pg	Catalog #	Pg
132095	509	132186	479	133262	195	134086	295	139620	484	139708	484	140788	547	141909	430
132096	509	132187	479	133263	195	134087	295	139621	484	139709	484	140789	547	141910	430
132097	509	132188	479	133264	195	134088	295	139622	484	139710	484	140790	547	141911	430
132098	509	132189	479	133265	195	134089	295	139623	484	139711	484	140791	547	141912	430
132099	509	132190	479	133266	195	134090	295	139624	484	139712	484	140792	547	141913	430
132100	545	132191	479	133267	195	134091	295	139625	484	139713	484	140793	547	141914	430
132101	545	132200	475	133268	195	134092	295	139626	484	139714	484	140794	547	141915	430
132103	572	132201	475	133269	195	134093	295	139627	484	139715	484	140795	547	141916	430
132104	471	132214	431	133270	195	134094	295	139628	484	139716	484	140796	547	141917	430
132105	471	132215	431	133271	195	134177	568	139629	484	139717	484	140797	547	141919	525
132106	471	132216	431	133272	195	134178	568	139630	484	139718	484	140798	547	141920	525
132107	471	132217	431	133273	195	134179	507	139631	484	139719	484	140799	547	141921	525
132108	471	132218	431	133274	195	134180	507	139632	484	139720	484	140800	547	141922	525
132109	471	132219	431	133275	195	134181	507	139633	484	139721	484	140801	547	141923	525
132110	471	132220	431	133276	195	134182	507	139634	484	139722	484	140802	547	141924	525
132111	471	132221	431	133277	195	134183	568	139635	484	139723	484	140803	547	141925	525
132112	471	132231	432	133278	195	134184	568	139636	484	139724	484	140804	547	141926	525
132113	471	132232	432	133279	195	134186	568	139637	484	139725	484	140805	547	141928	525
132114	471	132233	432	133280	195	134187	568	139638	484	139726	484	140806	547	141929	526
132115	471	132234	432	133281	195	134188	568	139639	484	139727	484	140807	547	141930	526
132116	471	132235	432	133282	195	134191	568	139640	484	139728	484	140808	547	141931	526
132117	471	132236	432	133283	195	134192	568	139641	484	139729	484	140809	547	141932	526
132118	471	132237	432	133284	195	134193	568	139642	484	139730	484	140810	547	141933	526
132119	471	132238	432	133285	195	134194	568	139643	484	139731	484	140811	547	141934	526
132120	471	132239	499	133286	195	134352	99	139644	484	139786	501	140812	547	141935	526
132121	471	132240	432	133287	195	139559	484	139645	484	139787	501	140813	547	141936	526
132122	471	132241	432	133288	195	139560	484	139646	484	139793	226	140814	547	141937	527
132123	471	132242	432	133289	195	139561	484	139647	484	139794	226	140815	547	141938	526
132124	471	132243	432	133290	195	139562	484	139648	484	139795	226	140816	547	141939	524
132125	471	132244	432	133291	195	139563	484	139649	484	139796	226	140817	547	141940	524
132126	471	132245	432	133292	195	139564	484	139650	484	139797	521	140818	547	141941	524
132127	471	132246	432	133293	195	139565	484	139651	484	139798	521	140819	547	141942	524
132128	471	132247	432	133294	195	139566	484	139652	484	139811	97	140820	547	141943	524
132129	471	140883	80	133295	195	139567	484	139653	484	139812	97	140821	547	141944	524
132130	471	132393	80	133296	195	139568	484	139654	484	139907	501	140822	547	141945	524
132131	476	140884	80	133481	311	139569	484	139655	484	140736	546	140823	547	141946	524
132136	488	132395	80	133482	311	139570	484	139656	484	140737	546	140824	547	141947	524
132137	488	132421	325	133483	311	139571	484	139657	484	140738	546	140825	547	141948	524
132138	488	132422	325	133484	311	139572	484	139658	484	140739	546	140826	547	141949	524
132139	488	132423	325	133485	311	139573	484	139659	484	140740	546	140827	547	141950	524
132140	488	132424	325	133486	311	139574	484	139660	484	140741	546	140828	547	141951	524
132141	488	132425	325	133487	310	139575	484	139661	484	140742	546	140829	547	141952	524
132142	488	132427	185	133488	310	139576	484	139662	484	140743	546	140830	547	141953	524
132143	488	132428	368	133489	203	139577	484	139663	484	140744	546	140831	547	141954	525
132144	488	132429	368	133490	203	139578	484	139664	484	140745	546	140832	547	141955	525
132145	488	132430	295	133491	203	139579	484	139665	484	140746	546	140833	547	141956	525
132146	488	132431	295	133492	203	139580	484	139666	484	140747	546	140834	547	141957	525
132147	488	132432	295	133493	203	139581	484	139667	484	140748	547	140835	547	141958	525
132148	488	132433	295	133494	203	139582	484	139668	484	140749	547	140836	547	141959	525
132149	488	132434	295	133495	203	139583	484	139669	484	140750	547	140837	547	141960	525
132150	488	132435	295	133496	203	139584	484	139670	484	140751	547	140838	547	141961	525
132151	488	132436	295	133497	203	139585	484	139671	484	140752	547	140839	547	141962	525
132152	476	132437	295	133498	203	139586	484	139672	484	140753	547	140840	547	141963	525
132153	476	132438	295	133499	203	139587	484	139673	484	140754	547	140841	547	141964	525
132154	476	132439	295	133500	203	139588	484	139674	484	140755	547	140842	547	141965	525
132155	476	132440	295	133501	203	139589	484	139675	484	140756	547	140843	547	141966	525
132156	476	132441	295	133502	203	139590	484	139676	484	140757	547	140844	547	141967	525
132157	476	132449	557	133503	203	139591	484	139677	484	140758	547	140845	547	141968	525
132158	476	132451	557	133504	203	139592	484	139678	484	140759	547	140846	547	141969	525
132159	476	132452	325	133505	203	139593	484	139679	484	140760	547	140847	547	141970	525
132160	476	132453	325	133506	203	139594	484	139680	484	140761	547	140848	547	141971	525
132161	476	132454	325	133507	203	139595	484	139681	484	140762	547	140849	547	141972	525
132162	476	132457	368	133508	203	139596	484	139682	484	140763	547	140850	547	141973	525
132163	476	132458	368	133509	203	139597	484	139683	484	140764	547	140851	547	142061	72
132164	476	133133	97	133510	203	139598	484	139684	484	140765	547	140852	547	142062	73
132165	476	133134	97	133511	203	139599	484	139685	484	140766	547	140853	547	142063	73
132166	476	133139	97	133512	203	139600	484	139686	484	140767	547	140854	547	142064	73
132167	476	133140	97	133513	203	139601	484	139687	484	140768	547	140855	547	142065	73
132168	476	133141	97	133514	203	139602	484	139688	484	140769	547	140856	547	142109	298
132169	476	133158	97	133515	203	139603	484	139689	484	140770	547	140857	547	142111	298
132170	476	133159	97	133516	203	139604	484	139690	484	140771	547	140858	547	142133	340
132171	476	133161	197	133517	203	139605	484	139691	484	140772	547	140859	547	142134	295
132172	476	133162	197	133518	203	139606	484	139692	484	140773	547	140860	547	142135	295
132173	476	133164	97	133519	203	139607	484	139693	484	140774	547	140861	547	142136	295
132174	476	133165	97	133520	203	139608	484	139694	484	140775	547	140862	547	142137	295
132175	476	133166	97	133521	203	139609	484	139695	484	140776	547	140863	547	142138	295
132176	476	133167	369	133522	203	139610	484	139696	484	140777	547	140864	547	142139	295
132177	476	133168	369	133523	203										

Part Number Index

BradyID.com/s36

Catalog #	Pg	Catalog #	Pg	Catalog #	Pg	Catalog #	Pg	Catalog #	Pg	Catalog #	Pg	Catalog #	Pg	Catalog #	Pg
143988	429	144075	431	144165	424	144263	421	144356	424	144443	429	144533	422	144621	426
143989	422	144076	431	144166	424	144265	421	144357	424	144444	429	144534	422	144622	426
143990	422	144077	431	144167	424	144266	421	144358	424	144445	429	144535	422	144623	433
143991	422	144078	431	144168	424	144267	421	144359	424	144446	422	144536	422	144624	433
143992	422	144079	431	144169	424	144268	421	144360	424	144447	422	144537	422	144625	433
143993	422	144080	431	144170	420	144269	421	144361	424	144448	422	144538	429	144626	433
143994	422	144081	431	144171	420	144270	421	144362	426	144449	422	144539	429	144627	433
143995	422	144082	431	144172	420	144271	421	144363	426	144450	422	144540	429	144628	433
143996	422	144083	431	144173	420	144272	421	144364	426	144451	422	144541	429	144630	426
143997	422	144084	431	144174	420	144273	421	144365	426	144452	430	144542	429	144632	426
143998	422	144085	431	144175	420	144274	421	144366	426	144453	430	144543	429	144634	426
143999	422	144086	431	144176	420	144275	421	144367	426	144454	430	144544	429	144635	426
144000	422	144087	431	144177	420	144276	421	144368	426	144455	430	144545	429	144636	427
144001	422	144088	431	144178	420	144277	421	144369	426	144456	430	144546	429	144637	427
144002	422	144089	423	144179	420	144278	421	144370	426	144457	430	144547	429	144638	427
144003	429	144090	423	144180	420	144279	421	144371	426	144458	426	144548	429	144639	427
144004	429	144091	423	144181	420	144280	421	144372	426	144459	428	144549	429	144640	427
144005	429	144092	423	144182	420	144281	421	144373	426	144460	428	144550	429	144641	427
144006	429	144093	423	144183	426	144282	421	144374	426	144461	428	144551	429	144642	427
144007	429	144094	423	144191	421	144283	421	144375	426	144462	428	144552	429	144643	427
144008	429	144095	423	144195	421	144284	421	144376	426	144463	428	144553	429	144644	428
144009	429	144096	423	144196	426	144285	421	144377	426	144464	428	144554	429	144645	428
144010	429	144097	423	144197	426	144286	421	144378	426	144465	428	144555	429	144648	428
144011	429	144098	423	144198	426	144287	421	144379	426	144466	428	144556	429	144651	428
144012	429	144099	423	144199	426	144288	421	144380	427	144467	425	144557	429	144652	428
144013	429	144100	423	144200	426	144289	421	144381	427	144468	425	144558	429	144657	428
144014	429	144101	423	144201	426	144290	421	144382	427	144469	425	144559	429	144658	428
144015	429	144102	431	144202	426	144291	421	144383	427	144470	425	144560	429	144659	428
144016	429	144103	431	144203	426	144292	421	144384	427	144471	425	144561	429	144660	428
144017	429	144104	431	144204	426	144293	421	144385	427	144472	425	144562	422	144661	428
144018	429	144105	431	144205	426	144294	421	144386	427	144473	426	144563	422	144662	429
144019	429	144106	431	144206	426	144295	421	144387	427	144474	426	144564	422	144663	429
144020	429	144107	431	144207	426	144296	421	144388	427	144475	426	144565	422	144664	429
144021	429	144108	423	144208	426	144297	426	144389	427	144476	426	144566	422	144665	429
144022	429	144109	423	144209	426	144298	421	144390	433	144477	426	144567	422	144666	429
144023	422	144110	423	144210	426	144299	421	144391	433	144478	426	144568	430	144667	429
144024	422	144111	423	144211	426	144300	421	144392	433	144479	426	144569	430	144668	429
144025	422	144112	423	144212	426	144301	421	144393	433	144480	426	144570	430	144669	428
144026	422	144113	423	144213	426	144302	421	144394	433	144481	426	144571	430	144670	428
144027	422	144114	426	144214	426	144303	421	144395	433	144482	429	144572	430	144671	428
144028	422	144116	426	144216	426	144304	426	144396	428	144483	429	144573	430	144672	428
144029	422	144117	426	144217	426	144305	421	144397	428	144484	429	144574	426	144674	428
144030	430	144118	426	144218	426	144306	426	144398	428	144485	429	144575	426	144675	428
144031	430	144119	426	144219	426	144307	426	144399	428	144486	429	144576	426	144676	433
144032	430	144120	426	144220	426	144308	426	144400	428	144487	429	144577	426	144677	433
144033	430	144121	421	144221	421	144309	426	144401	428	144488	429	144578	426	144678	433
144034	430	144122	421	144222	421	144310	426	144402	428	144489	429	144579	426	144679	433
144035	430	144126	422	144223	421	144311	426	144403	428	144490	429	144580	431	144680	433
144036	431	144127	422	144224	421	144312	421	144405	428	144491	429	144581	431	144681	433
144037	431	144128	422	144225	421	144313	421	144406	428	144492	429	144582	431	144682	430
144038	431	144129	422	144226	421	144314	421	144407	428	144493	429	144583	431	144683	430
144039	431	144130	422	144227	421	144315	421	144408	428	144494	422	144584	431	144684	430
144040	431	144131	422	144228	426	144316	421	144409	428	144495	422	144585	431	144685	430
144041	431	144132	426	144229	426	144317	421	144410	428	144496	422	144586	431	144686	430
144042	431	144133	426	144230	426	144324	422	144411	428	144497	422	144587	431	144687	430
144043	431	144134	426	144231	426	144325	422	144412	428	144498	422	144588	424	144688	430
144044	431	144135	426	144232	426	144326	422	144413	428	144499	422	144589	420	144689	430
144045	431	144136	426	144233	426	144327	422	144414	428	144500	422	144590	420	144690	430
144046	431	144137	426	144234	421	144328	422	144415	428	144502	422	144591	424	144691	430
144047	431	144138	421	144235	421	144329	422	144416	428	144504	423	144592	424	144692	430
144048	431	144139	421	144236	421	144330	424	144417	428	144506	423	144593	424	144693	430
144049	431	144140	421	144237	421	144331	424	144418	428	144508	423	144594	424	144694	430
144050	431	144141	421	144238	421	144332	424	144419	428	144509	423	144595	433	144695	430
144051	431	144142	421	144239	421	144333	424	144420	428	144510	423	144596	424	144696	430
144052	431	144143	421	144240	421	144334	424	144421	428	144511	423	144597	420	144697	430
144053	431	144144	426	144241	421	144335	424	144422	428	144512	423	144598	420	144698	430
144054	431	144145	426	144242	421	144336	420	144423	428	144513	423	144599	420	144699	430
144055	431	144146	426	144243	421	144337	420	144424	428	144514	429	144600	420	144700	431
144056	431	144147	426	144244	421	144338	420	144425	428	144515	429	144601	420	144701	431
144057	431	144148	426	144245	421	144339	420	144426	428	144516	429	144602	432	144702	431
144058	431	144149	426	144246	421	144340	420	144427	422	144517	429	144603	432	144703	431
144059	431	144150	426	144247	421	144341	424	144428	422	144518	429	144604	433	144705	431
144060	431	144151	427	144248	426	144342	424	144429	422	144519	429	144605	432	144706	431
144061	431	144152	427	144249	426	144343	424	144430	422	144520	423	144606	433	144707	431
144062	431	144153	427	144250	426	144344	424	144431	422	144521	423	144607	425	144708	431
144063	431	144154	427	144251	426	144345	424	144432	422	144522	423	144608	425	144709	431
144064	431	144155	427	144252	426	144346	424	144433	422	144523	423	144609	425	144710	431
144065	431	144156	427												

Part Number Index

BradyID.com/s36

Catalog #	Pg	Catalog #	Pg	Catalog #	Pg	Catalog #	Pg	Catalog #	Pg	Catalog #	Pg	Catalog #	Pg
145756	559	145846	345	145932	345	148699	219	150448	461	150974	244	ALU-SLV-38ST-KD	191
145757	559	145847	345	145933	345	148700	219	150449	461	150975	244	ALU-SLV-38ST-KD6PK	191
145758	559	145848	345	145934	345	148701	219	150450	461	150976	245	ALU-SLV-76ST-KA3PK	191
145759	559	145849	345	145935	345	148702	219	150451	461	150977	240	ALU-SLV-76ST-KA6PK	191
145760	559	145850	345	145936	345	148804	371	150452	461	150978	240	ALU-SLV-76ST-KD	191
145761	559	145851	345	145937	345	148805	371	150453	461	150979	239	ALU-SLV-76ST-KD6PK	191
145762	559	145852	345	145938	345	148806	299	150454	461	150980	239	ALU-YLW-38ST-KA3PK	191
145763	559	145853	345	145939	345	148807	299	150455	461	150981	234	ALU-YLW-38ST-KA6PK	191
145764	559	145854	345	145940	345	148808	299	150456	461	150982	234	ALU-YLW-38ST-KD	191
145765	559	145855	345	145941	345	148809	299	150457	461	150983	247	ALU-YLW-38ST-KD6PK	191
145766	204	145856	345	145942	345	148810	299	150458	461	150984	243	ALU-YLW-76ST-KA3PK	191
43490	204	145857	345	145943	345	148812	299	150459	461	150985	243	ALU-YLW-76ST-KA6PK	191
145768	204	145858	345	145944	345	148813	299	150460	461	150986	243	ALU-YLW-76ST-KD	191
145769	204	145859	345	145945	345	148814	299	150461	461	150987	240	ALU-YLW-76ST-KD6PK	191
145770	345	145860	345	145946	345	148815	299	150462	461	150988	240	AW124	270
145771	345	145861	345	145947	345	148816	299	150463	461	150989	231	AW1818	271
145772	345	145862	345	145948	345	148818	299	150464	461	150990	231	AW412	270
145773	345	145863	345	145949	345	148819	299	150465	461	236919	197	AW430	270
145774	345	145864	345	145950	345	148820	299	150466	461	833762	324	AW806	270
145775	345	145865	345	145951	345	148821	299	150467	461	833763	324	AW99	271
145776	345	145866	345	145952	345	148822	299	150468	461	833764	324	B30-17-438	55
145777	345	145867	345	145953	345	148823	299	150469	461	833918	185	B30-18-438	55
145778	345	145868	345	145954	345	148824	205	150470	461	871239	197	B30-18-7569-CLP4C	42
145779	345	145869	345	145956	371	148861	201	150471	461	873367	224	B30-25-595-ANSICA	44
145780	345	145870	345	145957	371	148862	201	150472	461	AD15100	266	B30-25-595-ANSIDA	44
145781	345	145871	345	145962	578	148863	201	150473	461	AD15100-BLUE	266	B30-25-595-ANSINO	44
145782	345	145872	345	145972	384	148864	201	150474	461	AD30100	266	B30-25-595-ANSIWA	44
145783	345	145873	345	145973	384	148865	201	150475	461	AD30100-BLUE	266	B30-25-595-BLNKWT	44
145784	345	145874	345	145974	384	148866	201	150476	461	ALU-BLK-38ST-KA3PK	191	B30-25-595-BLNKYL	44
145785	345	145875	345	145975	384	148867	201	150477	461	ALU-BLK-38ST-KA6PK	191	B30-25-595-OSHACA	44
145786	345	145876	345	146069	72	148869	201	150478	461	ALU-BLK-38ST-KD	191	B30-25-595-OSHADA	44
145787	345	145877	345	146070	72	149172	198	150479	461	ALU-BLK-38ST-KD6PK	191	B30-25-595-PEL	44
145788	345	145878	345	146071	72	149173	198	150480	461	ALU-BLK-76ST-KA3PK	191	B30-25-595-PREC	44
145789	345	145879	345	146072	72	149174	198	150481	461	ALU-BLK-76ST-KA6PK	191	B30-25-854-ANSICA	45
145790	345	145880	345	146073	72	149175	198	150482	461	ALU-BLK-76ST-KD	191	B30-25-854-ANSIDA	45
145791	345	145881	345	146074	38	149176	198	150483	461	ALU-BLK-76ST-KD6PK	191	B30-25-854-ANSIWA	45
145792	345	145882	345	146075	38	149228	210	150484	461	ALU-BLU-38ST-KA3PK	191	B30-25-854-OSHADA	45
145793	345	145883	345	146076	38	149229	210	150501	204	ALU-BLU-38ST-KA6PK	191	B30-25-854-PEL	45
145794	345	145884	345	146077	38	149230	210	150502	204	ALU-BLU-38ST-KD	191	B30-25-854-PREC	45
145795	345	145885	345	146078	38	149257	88	150503	38	ALU-BLU-38ST-KD6PK	191	B30-25-855-ANSICA	45
145796	345	145886	345	146079	38	149258	88	150504	204	ALU-BLU-76ST-KA3PK	191	B30-25-855-ANSIDA	45
145797	345	145887	345	146080	38	149259	88	150505	198	ALU-BLU-76ST-KA6PK	191	B30-25-855-ANSIWA	45
145798	345	145888	345	146081	38	149260	88	150555	190	ALU-BLU-76ST-KD	191	B30-25-855-OSHADA	45
145799	345	145889	345	146082	38	149278	224	150556	190	ALU-BLU-76ST-KD6PK	191	B30-25-855-PEL	45
145800	345	145890	345	146083	38	149279	224	150587	226	ALU-BRN-38ST-KA3PK	191	B30-25-855-PREC	45
145802	345	145891	345	146113	38	149280	224	150639	32	ALU-BRN-38ST-KA6PK	191	B30-161-595-DIAM	43
145805	345	145892	345	146114	38	149281	224	150640	32	ALU-BRN-38ST-KD	191	B30-219-595-BLNKWT	44
145807	345	145893	345	146115	38	149282	224	150642	32	ALU-BRN-38ST-KD6PK	191	B30-222-438	55
145808	345	145894	345	146116	38	149283	224	150643	32	ALU-BRN-76ST-KA3PK	191	B30-241-595-ANSICA	44
145809	345	145895	345	146117	38	149284	224	150645	32	ALU-BRN-76ST-KA6PK	191	B30-241-595-ANSIDA	44
145810	345	145896	345	146120	208	149285	224	150681	347	ALU-BRN-76ST-KD	191	B30-241-595-ANSINO	44
145811	345	145897	345	146121	208	149433	222	150682	347	ALU-BRN-76ST-KD6PK	191	B30-241-595-ANSIWA	44
145812	345	145898	345	146122	208	149434	222	150683	347	ALU-GRN-38ST-KA3PK	191	B30-241-595-BLNKWT	44
145813	345	145899	345	146123	208	149514	222	150684	347	ALU-GRN-38ST-KA6PK	191	B30-241-595-BLNKYL	44
145814	345	145900	345	146124	208	149515	222	150685	353	ALU-GRN-38ST-KD	191	B30-241-595-OSHACA	44
145815	345	145901	345	146125	208	149552	32	150740	318	ALU-GRN-38ST-KD6PK	191	B30-241-595-OSHADA	44
145816	345	145902	345	146126	208	149629	295	150741	318	ALU-GRN-76ST-KA3PK	191	B30-242-595-BLNKWT	44
145817	345	145903	345	146127	208	149630	295	150742	318	ALU-GRN-76ST-KA6PK	191	B30-244-595-CB	43
145818	345	145904	345	146128	208	149631	295	150743	318	ALU-GRN-76ST-KD	191	B30-244-595-DIAM	43
145819	345	145905	345	146129	208	149632	295	150744	318	ALU-GRN-76ST-KD6PK	191	B30-244-595-HMIG	43
145820	345	145906	345	146130	208	149633	295	150820	228	ALU-ORG-38ST-KA3PK	191	B30-244-595-NFPA	43
145821	345	145907	345	146131	208	149634	295	150821	228	ALU-ORG-38ST-KA6PK	191	B30-245-595-CB	43
145822	345	145908	345	146132	208	149635	295	150822	228	ALU-ORG-38ST-KD	191	B30-245-595-NFPA	43
145823	345	145909	345	146133	208	149636	295	150823	228	ALU-ORG-38ST-KD6PK	191	B30-246-595-HMIG	43
145824	345	145910	345	146134	208	149637	295	150841	228	ALU-ORG-76ST-KA3PK	191	B30-246-595-NFR	43
145825	345	145911	345	146135	208	149638	295	150852	295	ALU-ORG-76ST-KA6PK	191	B30-255-551-ANSICA	44
145826	345	145912	345	148081	229	149639	295	150938	191	ALU-ORG-76ST-KD	191	B30-255-551-ANSIDA	44
145827	345	145913	345	148137	521	149640	295	150949	232	ALU-ORG-76ST-KD6PK	191	B30-255-551-OSHADA	44
145828	345	145914	345	148139	521	149641	295	150951	230	ALU-PRP-38ST-KA3PK	191	B30-255-551-WHT	44
145829	345	145915	345	148646	211	149642	295	150952	230	ALU-PRP-38ST-KA6PK	191	B30-260-569-CLP4B	42
145830	345	145916	345	148647	211	149643	295	150953	245	ALU-PRP-38ST-KD	191	B30-260-7569-CLP1	42
145831	345	145917	345	148648	211	149644	295	150955	243	ALU-PRP-38ST-KD6PK	191	B30-260-7569-CLP2	42
145832	345	145918	345	148685	219	149645	295	150959	246	ALU-PRP-76ST-KA3PK	191	B30-260-7569-CLP3A	42
145833	345	145919	345	148686	219	149646	295	150960	246	ALU-PRP-76ST-KA6PK	191	B30-260-7569-CLP3B	42
145834	345	145920	345	148687	219	149647	295	150961	247	ALU-PRP-76ST-KD	191	B30-260-7569-CLP4A	42
145835	345	145921	345	148688	219	149648	295	150962	247	ALU-PRP-76ST-KD6PK	191	B30-260-7569-CLP4B	42
145836	345	145922	345	148689	219	150438	461	150963	247	ALU-RED-38ST-KA3PK	191	B30-261-569-CLP4B	42
145837	345	145923	345	148690	219	150439	461	150964	244	ALU-RED-38ST-KA6PK	191	B30-261-7569-CLP1	42
145838	345	145924	345	148691	219	150440	461	150965	247	ALU-RED-38ST-KD	191	B30-261-7569-CLP2	42
145839	345	145925	345	148692	219	150441	461	150966	247	ALU-RED-38ST-KD6PK	191	B30-261-7569-CLP3A	42
145840	345	145926	345	148693	219	150442	461	150967	232	ALU-RED-76ST-KA3PK	191	B30-261-7569-CLP3B	42
145841	345	145927	345	148694	219	150443	461	150969	232	ALU-RED-76ST-KA6PK	191	B30-261-7569-CLP4A	42
145842	345	145928	345	148695	219	150444	461	150970	2				

Part Number Index

BradyID.com/s36

Catalog #	Pg	Catalog #	Pg	Catalog #	Pg	Catalog #	Pg	Catalog #	Pg	Catalog #	Pg	Catalog #	Pg
B30-262-7569-CLP3A.....	42	B30C-2250-483BL-KT.....	49	B30C-4000-569-GN.....	41	B30EP-175-593-WT.....	51	B33-5-498.....	48	B33-53-7425.....	46	B33-149-483.....	48
B30-262-7569-CLP3B.....	42	B30C-2250-483GN-KT.....	49	B30C-4000-569-GY.....	41	B30EP-175-593-YL.....	51	B33-7-424.....	55	B33-55-423.....	52	B33-149-718.....	57
B30-262-7569-CLP4A.....	42	B30C-2250-483OR-KT.....	49	B30C-4000-569-LB.....	41	B30EP-176-593-BK.....	51	B33-7-483.....	48	B33-55-424.....	55	B33-149-724.....	56
B30-262-7569-CLP4B.....	42	B30C-2250-483RD-KT.....	49	B30C-4000-569-OC.....	41	B30EP-176-593-GN.....	51	B33-7-486.....	54	B33-55-434.....	54	B33-149-727.....	56
B30-263-595-CB.....	43	B30C-2250-483WT-KT.....	49	B30C-4000-569-OR.....	41	B30EP-176-593-WT.....	51	B33-8-427.....	59	B33-55-435.....	54	B33-151-490.....	70
B30-263-595-NFPA.....	43	B30C-2250-483YL-KT.....	49	B30C-4000-569-PK.....	41	B30EP-176-593-YL.....	51	B33-9-427.....	59	B33-55-483.....	48	B33-151-499.....	70
B30C-500-569-BK.....	41	B30C-2250-526.....	46	B30C-4000-569-PL.....	41	B30EP-177-593-BK.....	51	B33-10-427.....	59	B33-56-427.....	59	B33-151-7425.....	70
B30C-500-569-BL.....	41	B30C-2250-549-WT.....	49	B30C-4000-569-RD.....	41	B30EP-177-593-GN.....	51	B33-11-423.....	52	B33-58-727.....	56	B33-152-492.....	68
B30C-500-569-BR.....	41	B30C-2250-549-YL.....	49	B30C-4000-569-SB.....	41	B30EP-177-593-WT.....	51	B33-11-437.....	60	B33-59-486.....	54	B33-152-494-BL.....	67
B30C-500-569-CL.....	41	B30C-2250-565-SL.....	54	B30C-4000-569-TN.....	41	B30EP-177-593-YL.....	51	B33-11-472.....	61	B33-59-492.....	68	B33-152-494-GN.....	67
B30C-500-569-GN.....	41	B30C-2250-569-BK.....	41	B30C-4000-569-WT.....	41	B30EP-167U-593-BK.....	50	B33-11-718.....	57	B33-59-727.....	56	B33-152-494-OR.....	67
B30C-500-569-GY.....	41	B30C-2250-569-BL.....	41	B30C-4000-569-YL.....	41	B30EP-167U-593-GN.....	50	B33-11-727.....	56	B33-59-7425.....	68	B33-152-494-PK.....	67
B30C-500-569-LB.....	41	B30C-2250-569-BR.....	41	B30C-4000-581-WT.....	47	B30EP-167U-593-RD.....	50	B33-17-422.....	52	B33-68-490.....	68	B33-152-494-RD.....	67
B30C-500-569-OC.....	41	B30C-2250-569-CL.....	41	B30C-4000-581-YL.....	47	B30EP-167U-593-WT.....	50	B33-17-423.....	52	B33-68-498.....	48	B33-152-494-YL.....	67
B30C-500-569-OR.....	41	B30C-2250-569-GN.....	41	B30C-4000-584-OR.....	46	B30EP-167U-593-YL.....	50	B33-17-424.....	55	B33-68-499.....	48	B33-152-499.....	48
B30C-500-569-PK.....	41	B30C-2250-569-GY.....	41	B30C-4000-584-SL.....	46	B30-R4300.....	74	B33-17-425.....	56	B33-72-423.....	52	B33-152-7425.....	68
B30C-500-569-PL.....	41	B30C-2250-569-LB.....	41	B30C-4000-584-YL.....	46	B30-R4400-WT.....	74	B33-17-428.....	54	B33-72-718.....	57	B33-153-461.....	68
B30C-500-569-RD.....	41	B30C-2250-569-OC.....	41	B30C-4000-585-BK.....	40	B30-R4500-SV.....	74	B33-17-430.....	52	B33-72-727.....	56	B33-154-490.....	68
B30C-500-569-SB.....	41	B30C-2250-569-OR.....	41	B30C-4000-585-BL.....	40	B30-R6000.....	74	B33-17-432.....	53	B33-73-427.....	59	B33-155-490.....	68
B30C-500-569-TN.....	41	B30C-2250-569-PK.....	41	B30C-4000-585-BR.....	40	B30-R6200.....	74	B33-17-434.....	54	B33-74-427.....	59	B33-155-492.....	68
B30C-500-569-WT.....	41	B30C-2250-569-PL.....	41	B30C-4000-585-GD.....	40	B30-R6400.....	74	B33-17-483.....	48	B33-75-427.....	59	B33-156-490.....	68
B30C-500-569-YL.....	41	B30C-2250-569-RD.....	41	B30C-4000-585-GN.....	40	B30-R6600.....	74	B33-17-484.....	48	B33-76-422.....	52	B33-156-492.....	68
B30C-500-581-WT.....	47	B30C-2250-569-SB.....	41	B30C-4000-585-GY.....	40	B30-R6700-WT.....	74	B33-17-486.....	54	B33-76-486.....	54	B33-157-490.....	68
B30C-500-581-YL.....	47	B30C-2250-569-TN.....	41	B30C-4000-585-OR.....	40	B30-R10000.....	74	B33-17-489.....	53	B33-80-427.....	59	B33-158-490.....	68
B30C-500-595-BK.....	40	B30C-2250-569-WT.....	41	B30C-4000-585-OC.....	40	B30-R10000-BL.....	74	B33-18-422.....	52	B33-81-427.....	59	B33-161-486.....	54
B30C-500-595-BL.....	40	B30C-2250-569-YL.....	41	B30C-4000-585-PK.....	40	B30-R10000-CMYK-16.....	74	B33-18-423.....	52	B33-82-427.....	59	B33-163-492.....	68
B30C-500-595-BR.....	40	B30C-2250-581-WT.....	47	B30C-4000-585-PL.....	40	B30-R10000-CMYK-8.....	74	B33-18-424.....	55	B33-87-498.....	48	B33-163-499.....	48
B30C-500-595-CL.....	40	B30C-2250-581-YL.....	47	B30C-4000-585-RD.....	40	B30-R10000-GN.....	74	B33-18-425.....	46	B33-88-498.....	48	B33-165-499.....	48
B30C-500-595-GN.....	40	B30C-2250-584-OR.....	46	B30C-4000-585-RD.....	40	B30-R10000-KR-8.....	74	B33-18-428.....	52	B33-88-7425.....	46	B33-179-492.....	68
B30C-500-595-GD.....	40	B30C-2250-584-SL.....	46	B30C-4000-585-WT.....	40	B30-R10000-KB-16.....	74	B33-18-430.....	54	B33-89-498.....	48	B33-179-494-BL.....	67
B30C-500-595-GY.....	40	B30C-2250-584-YL.....	46	B30C-4000-724.....	56	B30-R10000-KB-8.....	74	B33-18-432.....	53	B33-90-498.....	48	B33-179-494-GN.....	67
B30C-500-595-OR.....	40	B30C-2250-595-BK.....	40	B30C-4000-727.....	56	B30-R10000-KG-16.....	74	B33-18-434.....	54	B33-91-498.....	60	B33-179-494-OR.....	67
B30C-500-595-PL.....	40	B30C-2250-595-BL.....	40	B30C-4000-787.....	53	B30-R10000-KG-8.....	74	B33-18-435.....	54	B33-94-2-342.....	62	B33-179-494-PK.....	67
B30C-500-595-RD.....	40	B30C-2250-595-BR.....	40	B30C-4000-854-WT.....	45	B30-R10000-KO-16.....	74	B33-18-484.....	48	B33-94-2-342-2.....	62	B33-179-494-RD.....	67
B30C-500-595-WT.....	40	B30C-2250-595-CL.....	40	B30C-4000-854-YL.....	45	B30-R10000-KO-8.....	74	B33-18-483.....	48	B33-94-2-342YL-2.....	62	B33-179-494-YL.....	67
B30C-500-595-YL.....	40	B30C-2250-595-GD.....	40	B30C-4000-855-WT.....	45	B30-R10000-KR-16.....	74	B33-18-486.....	54	B33-94-2-342YL-2.....	62	B33-179-7425.....	46
B30C-1125-403-WT.....	47	B30C-2250-595-GN.....	40	B30C-4000-855-YL.....	45	B30-R10000-KR-8.....	74	B33-18-489.....	53	B33-94-2-7642.....	65	B33-180-492.....	68
B30C-1125-483BK-KT.....	49	B30C-2250-595-GY.....	40	B30C-4250-509-WT.....	47	B30-R10000-KRBO-8.....	74	B33-19-422.....	52	B33-95-498.....	48	B33-181-492.....	68
B30C-1125-483BL-KT.....	49	B30C-2250-595-OC.....	40	B30C-4250-509-YL.....	47	B30-R10000-KRBO-16.....	74	B33-19-423.....	52	B33-102-422.....	52	B33-182-492.....	68
B30C-1125-483GN-KT.....	49	B30C-2250-595-OR.....	40	B30C-4250-551-WT.....	44	B30-R10000-KRKB-8.....	74	B33-19-424.....	55	B33-103-423.....	52	B33-183-461.....	68
B30C-1125-483OR-KT.....	49	B30C-2250-595-PL.....	40	B30EP-167-593-BK.....	50	B30-R10000-KRKB-16.....	74	B33-19-425.....	46	B33-103-717.....	57	B33-187-2-342.....	62
B30C-1125-483RD-KT.....	49	B30C-2250-595-RD.....	40	B30EP-167-593-GN.....	50	B30-R10000-KRYB-8.....	74	B33-19-428.....	54	B33-103-727.....	56	B33-187-2-342-2.....	62
B30C-1125-483WT-KT.....	49	B30C-2250-595-WT.....	40	B30EP-167-593-RD.....	50	B30-R10000-KRYB-16.....	74	B33-19-428.....	54	B33-113-427.....	59	B33-187-2-342YL.....	62
B30C-1125-483YL-KT.....	49	B30C-2250-595-YL.....	40	B30EP-167-593-WT.....	50	B30-R10000-KY-8.....	74	B33-19-434.....	54	B33-115-427.....	59	B33-187-2-7642.....	65
B30C-1125-526.....	46	B30C-2500-509-WT.....	47	B30EP-167-593-YL.....	50	B30-R10000-KY-16.....	74	B33-19-435.....	54	B33-116-427.....	59	B33-190-492.....	68
B30C-1125-549-WT.....	49	B30C-2500-509-YL.....	47	B30EP-168-593-BK.....	50	B30-R10000-MA.....	74	B33-19-483.....	48	B33-118-427.....	59	B33-194-481.....	67
B30C-1125-549-YL.....	49	B30C-2500-551-WT.....	44	B30EP-168-593-GN.....	50	B30-R10000-OR.....	74	B33-19-484.....	48	B33-119-427.....	59	B33-195-481.....	69
B30C-1125-565-SL.....	54	B30C-2250-855-WT.....	45	B30EP-168-593-RD.....	50	B30-R10000-PRCCY.....	74	B33-19-486.....	54	B33-120-427.....	59	B33-199-482.....	70
B30C-1125-569-BK.....	41	B30C-2250-855-YL.....	45	B30EP-168-593-WT.....	50	B30-R10000-PRCMIAG.....	74	B33-19-489.....	53	B33-121-427.....	59	B33-213-482.....	68
B30C-1125-569-BL.....	41	B30C-3000-438-SL.....	55	B30EP-168-593-YL.....	50	B30-R10000-PRCYEL.....	74	B33-20-424.....	55	B33-122-461.....	68	B33-235-7425.....	46
B30C-1125-569-BR.....	41	B30C-3000-483WT-KT.....	49	B30EP-169-593-BK.....	50	B30-R10000-RR-16.....	74	B33-25-424.....	55	B33-123-461.....	68	B33-235-7425-AC.....	67
B30C-1125-569-CL.....	41	B30C-3000-483YL-KT.....	49	B30EP-169-593-GN.....	50	B30-R10000-RR-8.....	74	B33-26-427.....	59	B33-125-2-342.....	62	B33-237-427.....	59
B30C-1125-569-GN.....	41	B30C-3000-569-WT.....	41	B30EP-169-593-RD.....	50	B30-R10000-YL.....	74	B33-27-427.....	59	B33-125-2-342-2.....	62	B33-250-2-342.....	62
B30C-1125-569-GY.....	41	B30C-3000-595-WT.....	40	B30EP-169-593-WT.....	50	B30-R10000-YL2.....	74	B33-29-423.....	52	B33-125-2-342YL.....	62	B33-250-2-342-2.....	62
B30C-1125-569-LB.....	41	B30C-3000-595-YL.....	40	B30EP-169-593-YL.....	50	B30-R10000-WT.....	74	B33-29-437.....	60	B33-125-2-342YL-2.....	62	B33-250-2-342YL.....	62
B30C-1125-569-OC.....	41	B30C-3250-551-WT.....	44	B30EP-170-593-BK.....	50	B31-CCT.....	32	B33-29-437YL.....	61	B33-125-2-7642.....	65	B33-250-2-7642.....	65
B30C-1125-569-OR.....	41	B30C-3000-403-WT.....	47	B30EP-170-593-GN.....	50	B31-WIPER.....	28	B33-29-472.....	60	B33-125-484.....	48	B33-250-494-BL.....	67
B30C-1125-569-PK.....	41	B30C-4000-403-WT.....	47	B30EP-170-593-RD.....	50	B33-1-423.....	52	B33-29-472YL.....	61	B33-125-499.....	68	B33-250-494-GN.....	67
B30C-1125-569-PL.....	41	B30C-4000-423.....	52	B30EP-170-593-WT.....	50	B33-1-437.....	50	B33-37-7425.....	46	B33-125-499.....	48	B33-250-494-OR.....	67
B30C-1125-569-RD.....	41	B30C-4000-424.....	55	B30EP-170-593-YL.....	50	B33-1-472.....	61	B33-38-423.....	52	B33-126-490.....	68	B33-250-494-PK.....	67
B30C-1125-569-SB.....	41	B30C-4000-428.....	54	B30EP-171-593-BK.....	51	B33-1-498.....	58	B33-38-718.....	57	B33-126-499.....	58	B33-250-494-RD.....	67
B30C-1125-569-TN.....	41	B30C-4000-432.....	53	B30EP-171-593-GN.....	51	B33-1-718.....	47	B33-38-719.....	57	B33-127-461.....	68	B33-250-494-YL.....	67
B30C-1125-569-WT.....	41	B30C-4000-434.....	54	B30EP-171-593-RD.....	51	B33-1-724.....	56	B33-38-727.....	56	B33-131-427.....	59	B33-251-7425.....	69
B30C-1125-569-YL.....	41	B30C-4000-437.....	60	B30EP-171-593-WT.....	51	B33-1-727.....	56	B33-43-423.....	52	B33-133-461.....	68	B33-256-7425.....	68
B30C-1125-581-WT.....	47	B30C-4000-480.....	54	B30EP-171-593-YL.....	51	B33-2-437.....	60	B33-43-717.....	57	B33-134-461.....	68	B33-257-7425.....	68
B30C-1125-581-YL.....	47	B30C-4000-483.....	53	B30EP-171-593-BK.....	51	B33-2-472.....	61	B33-43-718.....	57	B33-135-427AW.....	59	B33-258-7425.....	46
B30C-1125-584-OR.....	46	B30C-4000-483BK-KT.....	49	B30EP-171-593-GN.....	51	B33-2-719.....	57	B33-43-719.....	57	B33-136-422.....	52	B33-272-427.....	59
B30C-1125-584-SL.....	46	B30C-4000-483BL-KT.....	49	B30EP-171-593-RD.....	51	B33-2-724.....	56	B33-43-724.....	56	B33-136-434.....	54	B33-273-427.....	59
B30C-1125-584-YL.....	46	B30C-4											

Part Number Index

BradyID.com/s36

Catalog #	Pg	Catalog #	Pg	Catalog #	Pg	Catalog #	Pg	Catalog #	Pg	Catalog #	Pg	Catalog #	Pg
B33-1000-2-342YL-2	62	B33D-375-2-344	66	BM71-20-428	168	BM71-500-175-7641	167	BPTDS-30-390	135	CPT-ORG-25PL-KD	191	HANDYSORB-BASICPAD	271
B33-1000-2-7642	65	B33D-375-2-344BK	66	BM71-21-427	164	BM71-500-175-7641Y	167	BPTLTB-498-240	139	CPT-ORG-25PL-KD6PK	191	HANDYSORB-MOPKIT	271
B33-1500-2-342	62	B33D-375-2-344YL	66	BM71-23-427	164	BM71-750-1-7641	167	BPTLTB-498-318	139	CPT-PRP-25PL-KA3PK	191	HANDYSORB-NTPAD	271
B33-1500-2-342-2	62	B33D-375-2-345	64	BM71-29-423	168	BM71-750-1-7641Y	167	BPTLTB-498-375	139	CPT-PRP-25PL-KA6PK	191	HANDYSORB-NTPALLOW	271
B33-1500-2-342BK	62	B33D-375-2-345BK	64	BM71-29-427	164	BM71-750-175-7641	167	BPU100	255	CPT-PRP-25PL-KD	191	HAZ99	271
B33-1500-2-342YL	62	B33D-375-2-7641	65	BM71-29-498	162	BM71-750-175-7641Y	167	BPU200	255	CPT-PRP-25PL-KD6PK	191	HAZ124	270
B33-1500-2-342YL-2	62	B33D-375-2-7641Y	65	BM71-30-427	164	BM71-1000-175-342	165	BPU500	255	CPT-RED-25PL-KA3PK	191	HAZ412	270
B33-1500-2-7642	65	B33D-375-2-7642	65	BM71-31-427	164	BM71C-125-342	165	BR801B	377	CPT-RED-25PL-KA6PK	191	HAZ1818	271
B33-2000-2-7642	65	B33D-500-2-342	63	BM71-32-427	164	BM71C-187-342	165	BRH150	265	CPT-RED-25PL-KD	191	HT15	256
B33-6010-7643-WT	59	B33D-500-2-342BK	63	BM71-33-427	164	BM71C-240-498	161	BRH152	265	CPT-RED-25PL-KD6PK	191	HT30	256
B33-6010-7643-YL	59	B33D-500-2-342YL	63	BM71-34-427	164	BM71C-250-342	165	BRO150	261	CPT-WHT-25PL-KA3PK	191	HT153	256
B33-7510-7643-WT	59	B33D-500-2-344	66	BM71-40-412	160	BM71C-318-498	161	BRO152	261	CPT-WHT-25PL-KA6PK	191	HT215	256
B33-7510-7643-YL	59	B33D-500-2-344BK	66	BM71-64-427	164	BM71C-375-342	165	BRU152	255	CPT-WHT-25PL-KD	191	HT230	256
B33-7515-7643-WT	59	B33D-500-2-344YL	66	BM71-94-1-342	165	BM71C-375-498	161	BRU150	255	CPT-WHT-25PL-KD6PK	191	HT303	256
B33-7515-7643-YL	59	B33D-500-2-345	64	BM71-094-1-344	166	BM71C-500-342	165	BS07A-BU	212	CPT-YLW-25PL-KA3PK	191	HT350	256
B33-7525-7643-WT	59	B33D-500-2-345BK	64	BM71-094-1-344YL	166	BM71C-1000-342	165	BS07A-GN	212	CPT-YLW-25PL-KA6PK	191	HT555	256
B33-7525-7643-YL	59	B33D-500-2-7641	65	BM71-94-1-7641	167	BM71C-1000-582	157	BS07A-RD	212	CPT-YLW-25PL-KD	191	HTB815	268
B33C-312-422	61	B33D-500-2-7641Y	65	BM71-94-1-7641Y	167	BM71C-1000-584-OR	157	BS07A-YW	212	CPT-YLW-25PL-KD6PK	191	HTB830	268
B33C-312-498	61	B33D-500-2-7642	65	BM71-94-175-342	165	BM71C-1000-584-WT	157	BS08A-BU	212	CSP	551	HTB8100	268
B33C-375-422	61	B33D-750-2-342	63	BM71-94-175-342YL	165	BM71C-1000-584-YL	157	BS08A-GN	212	DGUARD9	276	IC326E	378
B33C-375-498	61	B33D-750-2-342BK	63	BM71-94-175-344	166	BM71C-1000-854-WT	155	BS08A-RD	212	DGUARD14	276	ISO-ISO 08	324
B33C-1000-437	60	B33D-750-2-342YL	63	BM71-94-175-344YL	166	BM71C-1000-854-YL	155	BS08A-YW	212	DGUARD910	276	J20-255-2551	85
B33C-1000-437YL	60	B33D-750-2-344	66	BM71-94-175-7641	167	BM71C-1000-855-WT	155	BSC20	270	DGUARD1410	276	J20-260-2569	85
B33C-1000-472	61	B33D-750-2-344BK	66	BM71-94-175-7641Y	167	BM71C-1000-855-YL	155	BSC40	270	DMC-1.3/3-15	135	J20-260-2596	85
B33C-1000-472YL	61	B33D-750-2-344YL	66	BM71-107-427	164	BM71C-2000-582	157	BSC5K-CB	284	DMC-1.3/3-30	135	J20-261-2569	85
B33C-1500-437	60	B33D-750-2-345	64	BM71-109-427	164	BM71C-2000-584-OR	157	BSM100	267	DMC-2.5/5-15	135	J20-261-2595	85
B33C-1500-437YL	60	B33D-750-2-345BK	64	BM71-110-145-GY	161	BM71C-2000-584-WT	157	BWS-DAS-CD	178	DMC-2.5/5-30	135	J20-262-2569	85
B33C-1500-472	61	B33D-750-2-7641	65	BM71-111-145-GY	161	BM71C-2000-584-YL	157	BWS-DAS-EM	178	DMC-4/10-15	135	J20-262-2596	85
B33C-1500-472YL	61	B33D-750-2-7641Y	65	BM71-125-1-342	165	BM71C-2000-854-CAU	155	BWS-PPS-CD	178	DMC-4/10-30	135	J20C-1125-2569	85
B33C-2000-437	60	B33D-750-2-7642	65	BM71-125-1-342-YL	165	BM71C-2000-854-DAN	155	BWS-PPS-CD-VOL	178	DMC-8/16-15	135	J20C-1125-2595	85
B33C-2000-437YL	60	B33D-1000-2-342	63	BM71-125-1-344	166	BM71C-2000-854-WAR	155	BWS-PPS-EM	178	DMC-8/16-30	135	J20C-2250-2569	85
B33C-2000-472	61	B33D-1000-2-342BK	63	BM71-125-1-344YL	166	BM71C-2000-854-WT	155	BWS-PPS-EM-VOL	178	PA24	277	J20C-2250-2595	85
B33C-2000-472YL	61	B33D-1000-2-342YL	63	BM71-125-1-7641	167	BM71C-2000-854-YL	155	BWS-PWIDS-CD	178	DPE	316	J20C-2500-2551	85
B33C-3000-428	54	B33D-1000-2-344	66	BM71-125-1-7641Y	167	BM71C-2000-855-CAU	155	BWS-PWIDS-EM	178	DRIP1720-B	277	J20C-3250-2551	85
B33C-3000-437	60	B33D-1000-2-344BK	66	BM71-125-175-342	165	BM71C-2000-855-DAN	155	BWS-PWIDS-EM-VOL	178	DRIP1720-Y	277	J20C-4000-2569	85
B33C-3000-437YL	60	B33D-1000-2-344YL	66	BM71-125-175-342YL	165	BM71C-2000-855-WAR	155	BWS-SFIDS-NA-CD	177	DTA25	271	J20C-4000-2595	85
B33C-3000-472	61	B33D-1000-2-345	64	BM71-125-175-344	166	BM71C-2000-855-WT	155	BWS-SFIDS-NA-EM	177	DT025	271	J20-CMY	84
B33C-3000-472YL	61	B33D-1000-2-345BK	64	BM71-125-175-344YL	166	BM71C-2000-855-YL	155	BWS-SPS-CD	178	DZ100	275	J20-PAD	84
B33D-94-2-342	63	B33D-1000-2-7641	65	BM71-125-175-7641	167	BMP-HC-1	128	BWS-SPS-EM	178	DZ200	275	J20-ROLL	84
B33D-94-2-342BK	63	B33D-1000-2-7641Y	65	BM71-125-175-7641Y	167	BMP-MAGNET-1	128	BWS-WIDS-EM	178	EHMVSD	314	J2000	84
B33D-94-2-342YL	63	B33D-1000-2-7642	65	BM71-125-175-7642	165	BMP-STRAP-1	128	BWRK-GHS-DWN	177	ENT-ETSH157	323	J2000	84
B33D-94-2-344	66	B33D-1500-2-342	63	BM71-187-1-342	165	BMP-STRAP-1	128	BWRK-LOW-DWN	177	ENT-ETSH157A	323	J2000-BWSSFD	84
B33D-94-2-344BK	66	B33D-1500-2-342BK	63	BM71-187-1-342YL	165	BMP-UBP	114	BWRK-LOW-CD	177	ENT-ETSH 500	323	J50-255-2551	88
B33D-94-2-344YL	66	B33D-1500-2-342BK	63	BM71-187-1-344	166	BMP-UBP-AC	114	CABLE	209	ENT-ETSH 505	323	J50-260-2569	88
B33D-94-2-345	64	B33D-1500-2-344YL	63	BM71-187-1-344YL	166	BMP21-MAGNET	104	CABLE-10FT	209	ENT-ETSH 506	323	J50-260-2596	88
B33D-94-2-345BK	64	B33D-1500-2-344	66	BM71-187-1-7641	167	BMP21-PLUS	104	CABLE	209	ENT-ETSH BLANK-FG	323	J50-261-2569	88
B33D-94-2-7641	65	B33D-1500-2-345BK	64	BM71-187-1-7641Y	167	BMP21-PLUS-BATT	104	CABLE-10	209	ENT-ETSH532	323	J50-261-2595	88
B33D-94-2-7642	65	B33D-1500-2-344YL	66	BM71-187-175-342	165	BMP21-PLUS-HC	104	CB305	273	ENT-ETSI 549	323	J50-262-2569	88
B33D-94-2-7642	65	B33D-1500-2-345	64	BM71-187-175-342YL	165	BMP21-PLUS-KIT1	104	CB612	273	ENT-ETSI 567	323	J50-262-2596	88
B33D-125-2-342	63	B33D-1500-2-7641	65	BM71-187-175-344	166	BMP21-TOOL	104	CC400	270	ENT-ETSI 594	323	J50-265-2569	88
B33D-125-2-342-2	63	B33D-1500-2-7641Y	65	BM71-187-175-344YL	166	BMP41	108	CH15P	264	ENV50	262	J50-265-2595	88
B33D-125-2-342BK	63	B33D-1500-2-7642	65	BM71-187-175-7641	167	BMP41-BATT	108	CH30DP	264	ENV100	262	J50-267-2569	88
B33D-125-2-342YL	63	B33D-2000-2-7642	65	BM71-187-175-7641Y	167	BMP41-HC	108	CH100	264	ENV150	262	J50-267-2596	88
B33D-125-2-344	66	B37-BLADE	34	BM71-250-1-342	165	BMP41-KIT-EL	108	CH124	270	ENV200	262	J50C-2250-2569	88
B33D-125-2-344BK	66	B85-DC	76	BM71-250-1-342-YL	165	BMP41-KIT-GI	108	CH200	264	ENV300	262	J50C-2250-2595	88
B33D-125-2-344YL	66	B85-DC	76	BM71-250-1-344	166	BMP41-KIT-VD	108	CH303	264	ENV500	262	J50C-4000-2569	88
B33D-125-2-345	64	BBP35	34	BM71-250-1-344YL	166	BMP41-MAGNET	108	CH412	270	ENV510	272	J50C-4000-2595	88
B33D-125-2-342	63	BBP35-37-WIPER	34	BM71-250-1-7641	167	BMP41-OC	108	CH1212	264	ENV810	272	J50C-6000-2569	88
B33D-125-2-345BK	64	BBP37	34	BM71-250-1-7641Y	167	BMP51	114	CH1212-50	264	EP1	319	J50C-6000-2595	88
B33D-125-2-7641	65	BBP85	76	BM71-250-175-342	165	BMP51-KIT-AC	114	CH1818	271	EPD	315	J50C-8000-2569	88
B33D-125-2-7641Y	65	BCK	379	BM71-250-175-342YL	165	BMP51-KIT-EL	125	CH1818	271	EPDISP	315	J50-8K	88
B33D-125-2-7642	65	BH2013	378	BM71-250-175-344	166	BMP51-KIT-GI	125	CHBB30	267	FC1	516	J50-CMYK	88
B33D-187-2-342	63	BH2023	378	BM71-250-175-344YL	166	BMP51-KIT-LS	125	CHBB100	267	FCS2-L	362	J50-CY	88
B33D-187-2-342BK	63	BLS	551	BM71-250-175-7641	167	BMP51-KIT-VD	125	CHEM-CTH BLANK -FG	324	FESP	551	J50-MA	88
B33D-187-2-342YL	63	BM15	256	BM71-250-175-7641Y	167	BMP61	128	CHEM-CTHUSA01	324	FLSP	551	J50-YL	88
B33D-187-2-344	66	BM30	256	BM71-375-1-342	165	BMP61-BATCOV	128	CHEM-CTSH	324	FLT-ETSH9	322	J5000	88
B33D-187-2-344BK	66	BM61-144-145-GY	134	BM71-375-1-342-YL	165	BMP61-CUTTER	128	CHEM-CTSH	324	FLT-ETSH9A	322	J5000	88
B33D-187-2-344YL	66	BM61-144-145FR-GY	134	BM71-375-1-344									

Part Number Index

BradyID.com/s36

Catalog #	Pg	Catalog #	Pg	Catalog #	Pg	Catalog #	Pg	Catalog #	Pg	Catalog #	Pg	Catalog #	Pg
LAD-EITL 500	322	M-49-494-OR	125	M-131-494-OR	125	M21-750-595-BR	105	M61C-750-403	148	M71-17-427	164	M71-32-427-YL	164
LAD-EITL 512	322	M-49-494-PK	125	M-131-494-PK	125	M21-750-595-GN	105	M61C-1000-584-OR	148	M71-17-428	168	M71-32-489	156
LAD-EITL521	322	M-49-494-RD	125	M-131-494-RD	125	M21-750-595-GY	105	M61C-1000-595-BK	147	M71-17-430	156	M71-32-498	162
LC202G	246	M-49-494-YL	125	M-131-494-YL	125	M21-750-595-OR	105	M61C-1000-595-BL	147	M71-17-472	163	M71-33-427	164
LC203G	246	M-49-498	113	M-131-498	113	M21-750-595-PL	105	M61C-1000-595-CL	147	M71-17-473	169	M71-33-427-YL	164
LC210G	247	M-51-427	112	M-131-499	110	M21-750-595-RD	105	M61C-1000-595-GN	147	M71-17-483	156	M71-33-498	162
LC211G	247	M-51-427-YL	112	M-132-499	117	M21-750-595-WT	105	M61C-1000-595-GR	147	M71-17-486	156	M71-34-427	164
LC226A	246	M-53-427	112	M-133-427	118	M21-750-595-YL	105	M61C-1000-595-OR	147	M71-17-489	156	M71-35-428-PROP	158
LC251M	242	M-53-427-YL	112	M-134-427	118	M21-750-7425	107	M61C-1000-595-RD	147	M71-17-498	162	M71-36-109	161
LC252M	242	M-60-428	111	M-135-427-AW	118	M21-1000-427	106	M61C-1000-595-WT	147	M71-17-724	169	M71-37-351	170
LC254M	242	M-60-483	110	M-136-427	112	M21-1250-427	106	M61C-1000-595-YL	147	M71-18-427	164	M71-37-362	170
LC501E	246	M-61-483	117	M-141-499	112	M21-1500-427	106	M61C-1000-8591	143	M71-18-498	162	M71-37-422	160
LC502E	246	M-72-461	123	M-143-427	112	M50-BATT-TRAY	114	M61C-1500-403	148	M71-18-499	162	M71-37-423	168
LC517E	245	M-74-461	123	M-152-499	119	M50-HC	114	M61C-1900-8591	143	M71-19-423	168	M71-37-483	156
LC517E-SK-AL	245	M-75-461	123	M-155-492	123	M50-MAGNET	114	M61C-2000-584-OR	148	M71-19-427	164	M71-37-486	156
LC517E-SK-NS	245	M-78-432-CL-BK	121	M-156-492	123	M61-2-7425	149	M61C-2000-584-SL	148	M71-19-427-YL	164	M71-38-423	168
LC518E	245	M-78-492	123	M-163-498	118	M61-7-7425	149	M61C-2000-584-YL	148	M71-19-472	163	M71-38-428	168
LC744E	246	M-81-488	124	M-187-1-342	119	M61-9-430	143	M61C-2000-595-BK	147	M71-19-483	156	M71-38-483	156
LCGDISP	314	M-82-492	123	M-187-075-342	112	M61-9-8459	143	M61C-2000-595-BL	147	M71-19-498	162	M71-38-483-CAUT	158
LGD03E	200	M-82-499	124	M-194-481	124	M61-10-430	143	M61C-2000-595-BR	147	M71-19-499	162	M71-38-483-DANG	158
LG008E	200	M-82-499-OR-BK	124	M-195-481	124	M61-17-494-BL	149	M61C-2000-595-CL	147	M71-20-351	170	M71-38-483-NOTI	158
LG252M	200	M-82-499-RD-BK	124	M-250-1-342	119	M61-17-494-GN	149	M61C-2000-595-GD	147	M71-20-362	170	M71-38-483-WARN	158
LH220A	197	M-82-499-YL-BK	124	M-250-075-342	112	M61-17-494-OR	149	M61C-2000-595-GN	147	M71-20-423	168	M71-38-489	156
LH625E	196	M-83-492	123	M-375-1-342	119	M61-17-494-PK	149	M61C-2000-595-LB	147	M71-20-424	168	M71-40-412	160
LID-3	303	M-83-499	124	M-375-075-342	112	M61-17-494-RD	149	M61C-2000-595-OR	147	M71-20-428	168	M71-45-422	160
LK041R	238	M-83-499-OR-BK	124	M-AC-110937	104	M61-17-494-YL	149	M61C-2000-595-PL	147	M71-20-459	156	M71-45-430	156
LK042R	238	M-83-499-RD-BK	124	M-AC-143110	108	M61-17-7425	149	M61C-2000-595-RD	147	M71-20-483	156	M71-61-483	156
LK300E	239	M-83-499-YL-BK	124	M-USB-103788	108	M61-17-8459	143	M61C-2000-595-WT	147	M71-20-486	156	M71-64-427	164
LK331E	239	M-84-499	110	M21-125-C-342	106	M61-18-7425	149	M61C-2000-595-YL	147	M71-21-427	164	M71-65-483	164
LK520B	238	M-86-461	123	M21-125-C-342-YL	106	M61-19-494-BL	149	M61-R4310	150	M71-21-427-YL	164	M71-66-427	156
LK627E	238	M-89-422	110	M21-187-C-342	106	M61-19-494-GN	149	M61-R4410-BL	150	M71-21-472	163	M71-68-430	156
LK627E-SK-AL	238	M-89-427	112	M21-187-C-342-YL	106	M61-19-494-OR	149	M61-R4410-RD	150	M71-21-498	162	M71-71-430	162
LK627E-SK-NS	238	M-90-422	110	M21-250-423	107	M21-19-494-PK	149	M61-R4410-WT	150	M71-21-499	162	M71-78-499	156
LK907E	239	M-90-427	112	M21-250-430	107	M61-19-494-RD	149	M61-R6010	150	M71-22-423	168	M71-80-488	156
LK980E	231	M-91-427	112	M21-250-430-WT-CL	107	M61-19-494-YL	149	M61-R6210	150	M71-22-428	168	M71-81-488	156
LK981E	231	M-91-427-YL	112	M21-250-595-WT	105	M61-22-430	143	M61-R6410	150	M71-23-423	168	M71-88-427	164
LKP	231	M-91-498	113	M21-250-595-YL	105	M61-29-8459	143	M61-R6610	150	M71-23-427	164	M71-94-1-342	165
LKP-SK-AL	231	M-92-428-BB	111	M21-250-C-342	106	M61-30-423	143	M61-R6710-WT	150	M71-23-483	156	M71-94-1-342YL	165
LKP-SK-NS	231	M-97-481	124	M21-250-C-342-YL	106	M61-30-430	143	M61-R6810-WT	150	M71-24-423-BK	168	M71-094-1-344	166
LKX	235	M-97-488	124	M21-375-423	107	M61-30-8459	143	M611-AM-BT-W	126	M71-25-423	168	M71-094-1-344YL	166
LKX-Rack	235	M-102-427	112	M21-375-430	107	M61-31-7425	149	M611-BC-KIT1	126	M71-25-718	169	M71-94-1-7641	167
LKX-SK-AL	235	M-103-498	118	M21-375-430-WT-CL	107	M61-37-430	143	M71-1-423	168	M71-26-423	168	M71-94-1-7641Y	167
LKX-SK-NS	235	M-111-145FR-GY	119	M21-375-461	107	M61-52-423	143	M71-2-423	168	M71-26-428	168	M71-94-175-342	165
LKXSET	235	M-112-490	123	M21-375-488	107	M61-52-430	143	M71-27-423	169	M71-27-423	168	M71-94-175-342YL	165
LKX-TKLBOX	241	M-113-490	123	M21-375-499	105	M61-61-423	143	M71-3-423	168	M71-28-423	168	M71-094-175-344	166
LM023E	225	M-114-490	123	M21-375-499-TB	106	M61-61-430	143	M71-4-423	168	M71-28-427	164	M71-094-175-344YL	166
LOCB	184	M-115-427	118	M21-375-595-BK	105	M61-78-430	143	M71-4-718	169	M71-28-473	169	M71-94-175-7641	167
LOSB1	378	M-116-427	118	M21-375-595-BL	105	M61-98-430	143	M71-5-423	168	M71-28-499	162	M71-94-175-7641Y	167
LOSC13	185	M-117-492	123	M21-375-595-BR	105	M61-98-494-BL	149	M71-6-423	168	M71-28-724	169	M71-96-427	164
LOSC13 BI	185	M-117-499	124	M21-375-595-GN	105	M61-98-494-GN	149	M71-6-473	169	M71-29-423	160	M71-97-488	156
LOSP22	378	M-118-492	123	M21-375-595-GY	105	M61-98-494-OR	149	M71-7-423	160	M71-29-427	164	M71-103-427	164
LOSP8	551	M-118-494-BL	125	M21-375-595-OR	105	M61-98-494-PK	149	M71-7-498	162	M71-29-428	168	M71-104-427	164
LOSP8SP	551	M-118-494-GN	125	M21-375-595-PL	105	M61-98-494-RD	149	M71-7-499	162	M71-29-437	163	M71-107-427	164
LRO08E	201	M-118-494-OR	125	M21-375-595-RD	105	M61-98-494-YL	149	M71-9-423	168	M71-29-459	156	M71-109-427	164
LRO18E	201	M-118-494-PK	125	M21-375-595-WT	105	M61-98-7425	149	M71-9-473	169	M71-29-472	163	M71-110-145FR-GY	161
LRO60E	201	M-118-494-RD	125	M21-375-595-YL	105	M61-121-7425	149	M71-9-718	169	M71-29-483	169	M71-110-145-GY	161
LR360E	201	M-118-494-YL	125	M21-375-7425	107	M61-144-145-GY	134	M71-9-724	169	M71-29-486	156	M71-111-145FR-GY	161
LROD101012	278	M-118-499	124	M21-375-C-342	106	M61-144-145FR-GY	134	M71-10-423	168	M71-29-489	156	M71-111-145-GY	161
LROD101512	278	M-118-7425	124	M21-375-C-342-YL	106	M61-145-145-GY	134	M71-10-427	164	M71-29-498	162	M71-125-1-342	165
LROD102012	278	M-119-461	123	M21-500-423	107	M61-145-145FR-GY	134	M71-10-437	163	M71-29-499	162	M71-125-1-342YL	165
LROD151512	278	M-120-492	123	M21-500-430	107	M61-196-8591	143	M71-10-472	163	M71-30-422	160	M71-125-1-344	166
LROD202012	278	M-120-494-BL	125	M21-500-430-WT-CL	107	M61-196-8591-SL	141	M71-10-473	169	M71-30-423-TEST	158	M71-125-1-344YL	166
M-7-422	110	M-120-494-GN	125	M21-500-461	107	M61-198-430	143	M71-10-498	162	M71-30-427	164	M71-125-1-7641	167
M-7-498	113	M-120-494-OR	125	M21-500-488	107	M61-199-7425	149	M71-10-727	169	M71-30-427-AW	164	M71-125-1-7641Y	167
M-11-427	112	M-120-494-PK	125	M21-500-499	105	M61C-240-498	139	M71-11-427	164	M71-30-427-BL	164	M71-125-175-342	165
M-11-498	113	M-120-494-RD	125	M21-500-499-TB	106	M61C-250-439	147	M71-11-498	162	M71-30-427-PL	164	M71-125-175-342YL	165
M-11-499	110	M-120-494-YL	125	M21-500-595-BK	105	M61C-250-439-YL	147	M71-11-499	162	M71-30-427-RD	164	M71-125-175-344	166
M-12-109	119	M-120-499	124	M21-500-595-BL	105	M61C-318-498	139	M71-12-109	161	M71-30-428-CALI	158	M71-125-175-344YL	166
M-17-351	122	M-122-461	123	M21-500-595-BR	105	M61C-375-422	139	M71-13-423	168	M71-30-459	156	M71-125-175-7641	167
M-17-432-CL-BK	121	M-123-461	123	M21-500-595-GN	105	M61C-375-430	139	M71-13-724	169	M71-30-472	163	M71-125-175-7641Y	167
M-20-351	122	M-124-461	123	M21-500-595-GY	105	M61C-375-439	147	M71-14-423	168	M71-30-483	156	M71-187-1-342	165
M-29-428	117	M-124-490	123	M21-500-595-OR	105	M61C-375-439-YL	147	M71-14-717	169	M71-30-486	156	M71-187-1-342YL	165
M-30-428	117	M-125-1-342	119	M21-500-595-PL	105	M61C-375-498	139	M71-15-423	168	M71-30-498	162	M71-187-1-344	166
M-31-7425	124	M-125-075-342	112	M21-500-595-RD	105	M61C-475-422	139	M71-15-428	168	M71-30-499	162	M71-187-1-344YL	166
M-32-427	118	M-125-461	123	M21-500-595-WT	105	M61C-500-422	139	M71-15-437	163	M71-31-351	170	M71-187-1-7641</	

Part Number Index

BradyID.com/s36

Catalog #	Pg	Catalog #	Pg	Catalog #	Pg	Catalog #	Pg	Catalog #	Pg	Catalog #	Pg	Catalog #	Pg
M71-250-17641Y	167	M71C-500-595-GY	154	M71EP-169-593-BK	158	MC-187-342-YL	112	MIC-MTI 500	320	NYL-BLU-38PL-KA6PK	190	OP100	260
M71-250-175-342	165	M71C-500-595-LB	154	M71EP-169-593-GN	158	MC-240-498	113	MIC-MTI PLAIN	320	NYL-BLU-38PL-KD	190	OP150DND	260
M71-250-175-342YL	166	M71C-500-595-OC	154	M71EP-169-593-RD	158	MC-250-342	112	MIC-MTIG B	320	NYL-BLU-38PL-KD6PK	190	OP300	260
M71-250-175-344	165	M71C-500-595-OR	154	M71EP-169-593-YL	158	MC-250-342-YL	112	MIC-MTIG G	320	NYL-BLU-38ST-KA3PK	190	OP315P	260
M71-250-175-344YL	166	M71C-500-595-PK	154	M71EP-171-593	159	MC-250-595-WT-BK	116	MIC-MTIG O	320	NYL-BLU-38ST-KA6PK	190	OP350-DP	260
M71-250-175-7641	167	M71C-500-595-PL	154	M71EP-171-593-BK	159	MC-250-595-YL-BK	116	MIC-MTIG P	320	NYL-BLU-38ST-KD	190	PBL2	227
M71-250-175-7641Y	167	M71C-500-595-RD	154	M71EP-171-593-GN	159	MC-318-498	113	MIC-MTIG R	320	NYL-BLU-38ST-KD6PK	190	PBL4	227
M71-375-1-342	165	M71C-500-595-SB	154	M71EP-171-593-RD	159	MC-375-412	113	MIC-MTIG W	320	NYL-BLU-76ST-KD	190	PBL6	227
M71-375-1-342YL	165	M71C-500-595-TN	154	M71EP-171-593-SL	159	MC-375-422	110	MIC-MTIG Y	320	NYL-BRN-38PL-KA3PK	190	PBL8	227
M71-375-1-344	166	M71C-500-595-WT	154	M71EP-171-593-YL	159	MC-375-461	123	MIC-MTIGPI B	320	NYL-BRN-38PL-KA6PK	190	PC1	379
M71-375-1-344YL	166	M71C-500-595-YL	154	M71EP-172-593	159	MC-375-498	113	MIC-MTIGPI G	320	NYL-BRN-38PL-KD	190	PCK-5	126
M71-375-1-7641	167	M71C-625-412	160	M71EP-172-593-BK	159	MC-375-499	110	MIC-MTIG O	320	NYL-BRN-38PL-KD6PK	190	PCK-6	34
M71-375-1-7641Y	167	M71C-625-422	160	M71EP-172-593-GN	159	MC-375-595-RD-WT	109	MIC-MTIGPI P	320	NYL-BRN-38ST-KA3PK	190	PD001E	317
M71-375-1-7641YL	167	M71C-750-403	157	M71EP-172-593-RD	159	MC-375-595-WT-BK	109	MIC-MTIGPI R	320	NYL-BRN-38ST-KA6PK	190	PD205A	317
M71-375-175-342	165	M71C-785-412	160	M71EP-172-593-SL	159	MC-375-595-YL-BK	109	MIC-MTIGPI W	320	NYL-BRN-38ST-KD	190	PD206A	317
M71-375-175-342YL	166	M71C-1000-422	160	M71EP-172-593-YL	159	MC-475-412	113	MIC-MTIGPI Y	320	NYL-BRN-38ST-KD6PK	190	PD228E	317
M71-375-175-344	166	M71C-1000-430	156	M71EP-173-593	159	MC-475-422	110	MIC-MTIUSA B	320	NYL-BRN-76ST-KD	190	PD240E	316
M71-375-175-344YL	166	M71C-1000-472	163	M71EP-173-593-BK	159	MC-500-422	110	MIC-MTIUSA G	320	NYL-BRN-38PL-KA3PK	190	PD241E	316
M71-375-175-7641	167	M71C-1000-472-YL	163	M71EP-173-593-GN	159	MC-500-461	123	MIC-MTIUSA O	320	NYL-BRN-38PL-KA6PK	190	PD244E	315
M71-375-175-7641Y	167	M71C-1000-483	156	M71EP-173-593-RD	159	MC-500-492	123	MIC-MTIUSA P	320	NYL-BRN-38PL-KD6PK	190	PD256E	317
M71-375-175-7641YL	167	M71C-1000-498	162	M71EP-173-593-SL	159	MC-500-499	110	MIC-MTIUSA R	320	NYL-BRN-38PL-KD6PK	190	PD264E	314
M71-500-1-342	165	M71C-1000-499	162	M71EP-173-593-YL	159	MC-500-584	110	MIC-MTIUSA W	320	NYL-BRN-38ST-KA3PK	190	PD265E	315
M71-500-1-342YL	166	M71C-1000-530	170	M71EP-174-593	159	MC-500-584-YL	110	MIC-MTIUSA Y	320	NYL-BRN-38ST-KA6PK	190	PD322E	316
M71-500-1-344	166	M71C-1000-581-WT	157	M71EP-174-593-BK	159	MC-500-595-BK-WT	109	MUL-BLANK - FG	322	NYL-BRN-38ST-KD	190	PD325E	316
M71-500-1-344YL	167	M71C-1000-581-YL	157	M71EP-174-593-GN	159	MC-500-595-BL-WT	109	MUL-EILT 540	322	NYL-BRN-38PL-KA3PK	190	PD399G	315
M71-500-175-342	165	M71C-1000-595-BK	154	M71EP-174-593-RD	159	MC-500-595-CL-BK	109	MPPE	317	NYL-BRN-76ST-KD	190	PD524E	316
M71-500-175-342YL	166	M71C-1000-595-BL	154	M71EP-174-593-SL	159	MC-500-595-CL-WT	109	MRO15	254	NYL-ORG-38PL-KA3PK	190	PD674E	374
M71-500-175-344	165	M71C-1000-595-BR	154	M71EP-174-593-YL	159	MC-500-595-GN-WT	109	MRO15-DP	254	NYL-ORG-38PL-KA6PK	190	PD701E	314
M71-500-175-344YL	166	M71C-1000-595-CL	154	M71EP-176-593	159	MC-500-595-OR-BK	109	MRO15P	254	NYL-ORG-38PL-KD	190	PD995E	314
M71-500-175-7641	167	M71C-1000-595-GD	154	M71EP-176-593-BK	159	MC-500-595-RD-WT	109	MRO30	254	NYL-ORG-38PL-KD6PK	190	PD997E	314
M71-500-175-7641Y	167	M71C-1000-595-GN	154	M71EP-176-593-GN	159	MC-500-595-WT-BK	109	MRO30-DP	254	NYL-ORG-38ST-KA3PK	190	PLLT2	205
M71-750-1-344	166	M71C-1000-595-GY	154	M71EP-176-593-RD	159	MC-500-595-WT-RD	109	MRO30P	254	NYL-ORG-38ST-KA6PK	190	PLLT4	228
M71-750-1-344YL	166	M71C-1000-595-LB	154	M71EP-176-593-YL	159	MC-500-595-YL-BK	109	MRO50	254	NYL-ORG-38ST-KD	190	PLO23	205
M71-750-1-7641	167	M71C-1000-595-OC	154	M71EP-180-593	158	MC-625-412	113	MRO100	254	NYL-ORG-38ST-KD6PK	190	PLO27E	229
M71-750-1-7641Y	167	M71C-1000-595-OR	154	M71EP-182-593	158	MC-625-422	110	MRO100-2	254	NYL-ORG-76ST-KD	190	PLUG2	276
M71-750-1-7641YL	167	M71C-1000-595-PK	154	M71EP-186-593	159	MC-750-403	122	MRO150DND	254	NYL-PRP-38PL-KA3PK	190	PLUG3	276
M71-750-175-344	166	M71C-1000-595-PL	154	M71EP-186-593-BK	159	MC-750-427	112	MRO215P	254	NYL-PRP-38PL-KA6PK	190	PLUG4	276
M71-750-175-344YL	166	M71C-1000-595-RD	154	M71EP-186-593-GN	159	MC-750-499	110	MRO300	254	NYL-PRP-38PL-KD	190	PLUG6	276
M71-750-175-7641	167	M71C-1000-595-SB	154	M71EP-186-593-RD	159	MC-750-584	110	MRO315P	254	NYL-PRP-38PL-KD6PK	190	PS125E	551
M71-750-175-7641Y	167	M71C-1000-595-TN	154	M71EP-186-593-SL	159	MC-750-584-YL	110	MRO350-DP	254	NYL-PRP-38ST-KA3PK	190	PS125S	551
M71-1000-1-342	165	M71C-1000-595-WT	154	M71EP-186-593-YL	159	MC-750-595-BK-WT	109	MS0	270	NYL-PRP-38ST-KA6PK	190	PS127E	552
M71-1000-1-342YL	165	M71C-1000-595-YL	154	M71EP-189-593	158	MC-750-595-BL-WT	109	MS124	270	NYL-PRP-38ST-KD	190	PS128E	551
M71-1000-175-342	165	M71C-1000-8591	156	M71EP-189-593-BK	158	MC-750-595-CL-BK	109	MS412	270	NYL-PRP-38ST-KD6PK	190	PS135E	551
M71-1000-175-342YL	165	M71C-1500-403	157	M71EP-189-593-GN	158	MC-750-595-CL-WT	109	MRS06	270	NYL-PRP-76ST-KD	190	PS139E	552
M71-1000-483-BK-KT	155	M71C-1500-472	163	M71EP-189-593-RD	158	MC-750-595-GN-WT	109	MSSP	552	NYL-RED-38PL-KA3PK	190	PS139S	552
M71-1000-483-BL-KT	155	M71C-1500-472-YL	163	M71EP-189-593-SL	158	MC-750-595-OR-BK	109	MUL-EITHUSA01	322	NYL-RED-38PL-KA6PK	190	PSFR-187-175-WT	135
M71-1000-483-BL-WT	155	M71C-1900-422	160	M71EP-190-593	159	MC-750-595-RD-WT	109	MUL-EITHUSA01A	322	NYL-RED-38PL-KD	190	PSFR-250-1-WT	135
M71-1000-483-BL-YL	155	M71C-1900-430	156	M71EP-190-593-BK	159	MC-750-595-WT-BK	109	MUL-EILT 230	320	NYL-RED-38PL-KD6PK	190	PSFR-250-1-YL	135
M71-1000-483-OR-KT	155	M71C-1900-483	156	M71EP-190-593-GN	159	MC-750-595-WT-RD	109	MUL-EILT535	322	NYL-RED-38ST-KA3PK	190	PSFR-250-175-YL	135
M71-1000-483-OR-KT	155	M71C-1900-498	162	M71EP-190-593-RD	159	MC-750-595-YL-BK	109	MVSD	314	NYL-RED-38ST-KA6PK	190	PSFR-500-1-WT	135
M71-1000-483-OR-WT	155	M71C-1900-499	162	M71EP-190-593-SL	159	MC-1000-427	118	MVSD	314	NYL-RED-38ST-KD	190	PSFR-750-175-BK	135
M71-1000-483-OR-YL	155	M71C-1900-8591	156	M71EP-190-593-YL	159	MC-1000-461	123	MVSDG	314	NYL-RED-38ST-KD6PK	190	PSHT-094-1-WT	138
M71-2000-483-BK-KT	155	M71C-2000-472	163	M71EP-191-593	159	MC-1000-499	124	MVSDM	314	NYL-RED-76ST-KD	190	PSHT-094-1-YL	138
M71-2000-483-BK-KT	155	M71C-2000-472-YL	163	M71EP-191-593-BK	159	MC-1000-584	121	MVSDO	314	NYL-WHT-38PL-KA3PK	190	PSHT-094-175-WT	138
M71-2000-483-BK-WT	155	M71C-2000-530	170	M71EP-191-593-GN	159	MC-1000-584-YL	121	MXO1000	262	NYL-WHT-38PL-KA6PK	190	PSHT-094-175-YL	138
M71-2000-483-BK-YL	155	M71C-2000-581-WT	157	M71EP-191-593-RD	159	MC-1250-427	118	MXP-C20	281	NYL-WHT-38PL-KD	190	PSHT-1000-1-WT	138
M71-2000-483-OR-KT	155	M71C-2000-581-YL	157	M71EP-191-593-SL	159	MC-1250-461	123	MXP-P20	281	NYL-WHT-38PL-KD6PK	190	PSHT-1000-1-YL	138
M71-2000-483-OR-KT	155	M71C-2000-595-BK	154	M71EP-191-593-YL	159	MC-1500-403	122	MXP-L20	281	NYL-WHT-38ST-KA3PK	190	PSHT-1000-175-WT	138
M71-2000-483-OR-WT	155	M71C-2000-595-BL	154	M71EP-192-593	159	MC-1500-427	118	MXU1000	255	NYL-WHT-38ST-KA6PK	190	PSHT-1000-175-YL	138
M71-2000-483-OR-YL	155	M71C-2000-595-BR	154	M71EP-192-593-BK	159	MC-1500-584	121	NAN-GP B	319	NYL-WHT-38ST-KD	190	PSHT-125-1-BK	138
M71-240-498	161	M71C-2000-595-CL	154	M71EP-192-593-GN	159	MC-1500-584-YL	121	NAN-GP G	319	NYL-WHT-38ST-KD6PK	190	PSHT-125-1-BL	138
M71C-250-595-WT	154	M71C-2000-595-GD	154	M71EP-192-593-RD	159	MC-1500-595-BK-WT	116	NAN-GP O	319	NYL-WHT-76ST-KD	190	PSHT-125-1-PK	138
M71C-250-595-YL	154	M71C-2000-595-GN	154	M71EP-192-593-SL	159	MC-1500-595-BL-WT	116	NAN-GP P	319	NYL-YLW-38PL-KA3PK	190	PSHT-125-1-WT	138
M71C-318-498	161	M71C-2000-595-GY	154	M71EP-192-593-YL	159	MC-1500-595-CL-BK	116	NAN-GP R	319	NYL-YLW-38PL-KA6PK	190	PSHT-125-1-YL	138
M71C-375-412	160	M71C-2000-595-LB	154	M71FP-1-425	161	MC-1500-595-CL-WT	116	NAN-GP W	319	NYL-YLW-38PL-KD	190	PSHT-125-175-BL	138
M71C-375-422	160	M71C-2000-595-OC	154	M71FP-2-425	161	MC-1500-595-GN-WT	116	NAN-GP Y	319	NYL-YLW-38PL-KD6PK			

Part Number Index

BradyID.com/s36

Catalog #	Pg	Catalog #	Pg	Catalog #	Pg	Catalog #	Pg	Catalog #	Pg	Catalog #	Pg	Catalog #	Pg
PSHT-750-175-WT	138	PSPT-750-1-YL	136	PTL-10-473	144	PTL-20-483	142	PTL-30-422	142	PTL-37-422	142	PTL-109-427	130
PSHT-750-175-YL	138	PSPT-750-2-BK-R	137	PTL-10-498	133	PTL-20-486	141	PTL-30-423-CALI	142	PTL-37-424	145	PTL-111-145-GY	134
PSPT-094-1-BL	137	PSPT-750-2-WT-R	136	PTL-10-717	144	PTL-20-489	146	PTL-30-423-INSP	142	PTL-37-428	141	PTL-111-145FR-GY	134
PSPT-094-1-GR	137	PSPT-750-2-YL-R	136	PTL-10-718	144	PTL-20-7546	148	PTL-30-423-TEST	142	PTL-37-435	141	PTL-110-145FR-GY	134
PSPT-094-1-OR	137	PSPT-750-175-WT	136	PTL-10-719	144	PTL-20-7576	148	PTL-30-427-AW	130	PTL-37-483	142	PTL-110-145-GY	134
PSPT-094-1-RD	137	PSPT-750-175-YL	136	PTL-10-724	145	PTL-21-427-BL	132	PTL-30-427-BL	132	PTL-37-486	141	PTL-117-499	133
PSPT-094-1-WT	136	PSPT-1000-1-WT	136	PTL-10-727	145	PTL-21-427-BR	132	PTL-30-427-BR	132	PTL-37-489	146	PTL-157-427	130
PSPT-094-1-YL	136	PSPT-1000-1-YL-R	136	PTL-10-8425	134	PTL-21-427-GR	131	PTL-30-427-GR	131	PTL-37-576	148	PTLEP-167-593	140
PSPT-094-2-BK-R	137	PSPT-1000-2-BK-R	137	PTL-11-427	130	PTL-21-427-GY	132	PTL-30-427-GY	132	PTL-38-422	142	PTLEP-167-593-BK	140
PSPT-094-2-WT-R	136	PSPT-1000-2-WT-R	136	PTL-11-427-YL	130	PTL-21-427-OR	131	PTL-30-427-OR	131	PTL-38-424	145	PTLEP-167-593-GN	140
PSPT-094-2-YL-R	136	PSPT-1000-2-YL-R	136	PTL-11-432	146	PTL-21-427-PL	132	PTL-30-427-PL	132	PTL-38-428	141	PTLEP-167-593-RD	140
PSPT-094-175-BL	136	PSPT-1000-175-BK	137	PTL-11-498	133	PTL-21-427-RD	131	PTL-30-427-RD	131	PTL-38-435	141	PTLEP-167-593-YL	140
PSPT-094-175-OR	137	PSPT-1000-175-OR	137	PTL-11-499	133	PTL-21-427-YL	130	PTL-30-427-YL	130	PTL-38-483	142	PTLEP-168-593	140
PSPT-094-175-WT	136	PSPT-1000-175-BR	137	PTL-12-109	134	PTL-21-498	133	PTL-30-428-CALI	141	PTL-38-486	141	PTLEP-168-593-BK	140
PSPT-094-175-YL	136	PSPT-1000-175-GR	137	PTL-13-423	142	PTL-21-499	133	PTL-30-435	141	PTL-38-489	146	PTLEP-168-593-GN	140
PSPT-125-1-BK	137	PSPT-1000-175-GY	137	PTL-13-718	144	PTL-21-642	132	PTL-30-459	146	PTL-39-422	142	PTLEP-168-593-RD	140
PSPT-125-1-BL	137	PSPT-1000-175-OR	137	PTL-13-719	144	PTL-22-422	142	PTL-30-483	142	PTL-39-430	143	PTLEP-168-593-YL	140
PSPT-125-1-RD	137	PSPT-1000-175-PK	137	PTL-13-724	145	PTL-22-423	142	PTL-30-486	141	PTL-40-412	134	PTLEP-169-593	140
PSPT-125-1-WT	136	PSPT-1000-175-RD	137	PTL-13-727	145	PTL-22-424	145	PTL-30-489	146	PTL-41-437-WT	133	PTLEP-169-593-BK	140
PSPT-125-1-YL	136	PSPT-1000-175-VT	137	PTL-14-423	142	PTL-22-428	141	PTL-30-498	133	PTL-41-437-YL	133	PTLEP-169-593-GN	140
PSPT-125-2-BK-R	137	PSPT-1000-175-WT	136	PTL-14-717	144	PTL-23-422	142	PTL-30-499	133	PTL-42-422	142	PTLEP-169-593-RD	140
PSPT-125-2-WT-R	136	PSPT-1000-175-YL	136	PTL-14-718	144	PTL-23-423	143	PTL-31-351	148	PTL-42-430	142	PTLEP-169-593-YL	140
PSPT-125-2-YL-R	136	PTDS-15-390	135	PTL-14-727	145	PTL-23-427	130	PTL-31-423	143	PTL-42-432	146	PTLEP-171-593	140
PSPT-125-175-GR	137	PTDS-30-390	135	PTL-15-423	142	PTL-23-427-BL	132	PTL-31-427	130	PTL-42-439	147	PTLEP-171-593-BK	140
PSPT-125-175-OR	137	PTL-1-423	143	PTL-15-428	141	PTL-23-427-BR	132	PTL-31-427-BL	132	PTL-42-439-BK	147	PTLEP-171-593-GN	140
PSPT-125-175-WT	136	PTL-1-473	144	PTL-15-437	133	PTL-23-427-GR	131	PTL-31-427-BR	132	PTL-42-439-BL	147	PTLEP-171-593-RD	140
PSPT-125-175-YL	136	PTL-1-717	144	PTL-15-498	133	PTL-23-427-GY	132	PTL-31-427-GR	131	PTL-42-439-GR	147	PTLEP-171-593-SL	140
PSPT-187-1-BK	137	PTL-1-718	144	PTL-16-422	142	PTL-23-427-OR	131	PTL-31-427-GY	132	PTL-42-439-OR	147	PTLEP-173-593	140
PSPT-187-1-BL	137	PTL-1-724	145	PTL-16-423	142	PTL-23-427-PL	132	PTL-31-427-OR	131	PTL-42-439-RD	147	PTLEP-173-593-BK	140
PSPT-187-1-GR	137	PTL-1-727	145	PTL-16-430	142	PTL-23-427-RD	131	PTL-31-427-PL	132	PTL-42-439-YL	147	PTLEP-173-593-GN	140
PSPT-187-1-RD	137	PTL-2-423	143	PTL-16-435	141	PTL-23-427-YL	130	PTL-31-427-RD	131	PTL-42-483	142	PTLEP-173-593-RD	140
PSPT-187-1-VT	137	PTL-2-717	144	PTL-16-473	144	PTL-23-483	142	PTL-31-427-YL	130	PTL-42-489	146	PTLEP-173-593-SL	140
PSPT-187-1-WT	136	PTL-2-724	145	PTL-16-483	142	PTL-23-488	133	PTL-31-435	141	PTL-43-422	142	PTLEP-173-593-YL	140
PSPT-187-1-YL	136	PTL-2-727	145	PTL-16-486	141	PTL-23-499	133	PTL-31-483	142	PTL-43-430	142	PTLEP-174-593	140
PSPT-187-2-BK-R	137	PTL-3-423	142	PTL-16-489	146	PTL-24-423-BK	143	PTL-31-486	141	PTL-43-432	146	PTLEP-174-593-BK	140
PSPT-187-2-WT-R	136	PTL-3-717	144	PTL-16-498	133	PTL-24-428-BK	141	PTL-31-489	146	PTL-43-439	147	PTLEP-174-593-GN	140
PSPT-187-2-YL-R	136	PTL-3-718	144	PTL-16-499	133	PTL-24-483-BK	142	PTL-31-498	133	PTL-43-439-BK	147	PTLEP-174-593-RD	140
PSPT-187-175-BK	137	PTL-3-724	145	PTL-16-718	144	PTL-24-486-BK	141	PTL-31-499	133	PTL-43-439-BL	147	PTLEP-174-593-SL	140
PSPT-187-175-GR	137	PTL-3-727	145	PTL-16-719	144	PTL-25-423	143	PTL-31-642	132	PTL-43-439-GR	147	PTLEP-174-593-YL	140
PSPT-187-175-OR	137	PTL-4-423	142	PTL-16-724	145	PTL-25-717	144	PTL-31-7546	148	PTL-43-439-OR	147	PTLEP-176-593	140
PSPT-187-175-RD	137	PTL-4-718	144	PTL-16-727	145	PTL-25-724	145	PTL-31-7576	148	PTL-43-439-RD	147	PTLEP-176-593-BK	140
PSPT-187-175-WT	136	PTL-4-719	144	PTL-17-351	148	PTL-26-423	143	PTL-32-422	142	PTL-43-439-YL	147	PTLEP-176-593-GN	140
PSPT-187-175-YL	136	PTL-4-724	145	PTL-17-422	142	PTL-26-428	141	PTL-32-423	143	PTL-43-483	142	PTLEP-176-593-RD	140
PSPT-250-1-BK	137	PTL-4-727	145	PTL-17-423	142	PTL-27-423	143	PTL-32-427	130	PTL-43-489	146	PTLEP-176-593-SL	140
PSPT-250-1-OR	137	PTL-5-422	142	PTL-17-427	130	PTL-27-717	144	PTL-33-427	130	PTL-44-422	142	PTLEP-176-593-YL	140
PSPT-250-1-PK	137	PTL-5-423	142	PTL-17-427-YL	130	PTL-27-724	145	PTL-34-427	130	PTL-44-430	142	PTLFP-01-425	134
PSPT-250-1-RD	137	PTL-5-473	144	PTL-17-428	141	PTL-28-423	143	PTL-34-498	133	PTL-45-422	142	PTLFP-01-8425	134
PSPT-250-1-WT	136	PTL-6-423	142	PTL-17-430	142	PTL-28-427	142	PTL-35-423-PROP	143	PTL-45-430	142	PTLFP-02-425	134
PSPT-250-1-YL	136	PTL-6-430	142	PTL-17-432	146	PTL-28-427-BL	132	PTL-37-423	143	PTL-46-430	142	PTLFP-01-425	134
PSPT-250-2-BK-R	137	PTL-6-473	144	PTL-17-435	141	PTL-28-427-BR	132	PTL-37-483-WARNING	142	PTL-55-412	134	PTLFP-01-8425	134
PSPT-250-2-WT-R	136	PTL-6-718	144	PTL-17-473	144	PTL-28-427-GR	131	PTL-38-423	143	PTL-56-412	134	PTLFP-54-425	134
PSPT-250-2-YL-R	136	PTL-6-719	144	PTL-17-483	142	PTL-28-427-GY	132	PTL-38-483-WARNING	142	PTL-57-412	134	PTLSL-17-473	144
PSPT-250-175-GR	137	PTL-6-724	145	PTL-17-486	141	PTL-28-427-OR	131	PTL-46-422	142	PTL-58-412	134	PTLTB-498-240	139
PSPT-250-175-OR	137	PTL-6-727	145	PTL-17-489	146	PTL-28-427-PL	132	PTL-59-412	134	PTL-59-412	134	PTLTB-498-318	139
PSPT-250-175-RD	137	PTL-7-422	142	PTL-17-498	133	PTL-28-427-RD	131	PTL-61-483	142	PTL-61-483	142	PTLTB-498-375	139
PSPT-250-175-WT	136	PTL-7-423	142	PTL-17-719	144	PTL-28-427-YL	140	PTL-62-483	142	PTL-62-483	142	PTPSL-17-422	142
PSPT-250-175-YL	136	PTL-7-430	142	PTL-17-724	145	PTL-28-430	132	PTL-63-483	142	PTL-63-483	142	PTPSL-17-424	145
PSPT-375-1-BL	137	PTL-7-498	133	PTL-17-7546	148	PTL-28-473	144	PTL-32-427-OR	131	PTL-64-427	130	PTPSL-17-428	141
PSPT-375-1-GY	137	PTL-7-499	133	PTL-18-427	130	PTL-28-498	133	PTL-32-427-PL	132	PTL-65-483	142	PTPSL-20-422	142
PSPT-375-1-OR	137	PTL-8-422	142	PTL-18-427-YL	130	PTL-28-499	133	PTL-32-427-RD	131	PTL-66-427	130	PTPSL-20-424	145
PSPT-375-1-RD	137	PTL-8-423	142	PTL-18-498	133	PTL-28-717	144	PTL-32-427-YL	130	PTL-71-430	142	PTPSL-20-428	141
PSPT-375-1-WT	136	PTL-8-428	141	PTL-18-499	133	PTL-28-718	144	PTL-32-435	141	PTL-74-427	130	PTPSL-26-422	142
PSPT-375-1-YL	136	PTL-8-430	142	PTL-19-422	142	PTL-28-719	144	PTL-32-483	142	PTL-75-427	130	PTPSL-26-428	141
PSPT-375-2-BK-R	137	PTL-8-432	146	PTL-19-423	142	PTL-28-724	145	PTL-32-486	141	PTL-78-427-AW	130	PTPSL-50-422	142
PSPT-375-2-WT-R	136	PTL-8-439	147	PTL-19-427	130	PTL-28-727	145	PTL-32-489	146	PTL-78-488	146	PTPSL-50-428	141
PSPT-375-2-YL-R	136	PTL-8-439-BK	147	PTL-19-427-BL	132	PTL-29-422	142	PTL-32-498	133	PTL-78-499	133	PTS-0-45-350-321	135
PSPT-375-175-BL	137	PTL-8-439-BL	147	PTL-19-427-BR	132	PTL-29-423	143	PTL-33-427-BL	132	PTL-80-424	145	PTS-0-45-500-321	135
PSPT-375-175-GR	137	PTL-8-439-GR	147	PTL-19-427-GR	131	PTL-29-427	130	PTL-33-427-BR	132	PTL-80-488	146	PTS-0-95-1000-321	135
PSPT-375-175-OR	137	PTL-8-439-OR	147	PTL-19-427-GY	132	PTL-29-427-BL	132	PTL-33-427-GR	131	PTL-81-488	146	PTS-0-95-350-321	135
PSPT-375-175-PK	137	PTL-8-439-RD	147	PTL-19-427-OR	131	PTL-29-427-BR	132	PTL-33-427-GY	132	PTL-81-499	133	PTS-0-95-500-321	135
PSPT-375-175-RD	137	PTL-8-439-YL	147	PTL-19-427-PL	132	PTL-29-427-GR	131	PTL-33-427-OR	131	PTL-84-499	133	PTS-0-95-750-321	135
PSPT-375-175-WT	136	PTL-8-483	142	PTL-19-427-RD	131	PTL-29-427-GY	132	PTL-33-427-PL	132	PTL-87-427	130	PTS-1-90-1000-321	135
PSPT-375-175-YL	136	PTL-8-489	146	PTL-19-427-YL	130	PTL-29-427-OR	131	PTL-33-427-RD	13				

Part Number Index

BradyID.com/s36

Catalog #	Pg	Catalog #	Pg	Catalog #	Pg	Catalog #	Pg	Catalog #	Pg	Catalog #	Pg	Catalog #	Pg	Catalog #	Pg
R6210	150	SH1219	579	SKO55W	290	SXT30DP	262	WO-10-PK	388	WOAF-38-PK	389	XC-1000-595-WT-BK	173		
R6410	150	SH1420	579	SKO55-R	290	SXT100	262	WO-10-VP	388	WOAF-46	388	XC-1000-595-WT-RD	173		
R6810-WT	150	SH1824	579	SKO65	291	SXT200	262	WO-11	388	WOAF-53	388	XC-1000-595-YL-BK	173		
RAG1818	269	SIR36	269	SKO65-R	291	SXT300	262	WO-11-PK	388	WOAF-53-PK	388	XC-1500-595-BL-WT	173		
RAG36150	269	SIR36150	269	SKO-95	292	T218	197	WO-14	388	WOS-1	389	XC-1500-595-CL-BK	173		
RF100	259	SK-BATT	286	SKO95-R	286	T220	197	WO-16	388	WOS-10	389	XC-1500-595-GN-WT	173		
RF300	259	SK-BF	285	SKO-95W	292	TAMPER	287	WO-17	388	WOS-41	389	XC-1500-595-OR-BK	173		
RF500	259	SK-FORM	287	SKO-ATK	281	TC8	207	WO-17-PK	388	WOX-1	389	XC-1500-595-RD-WT	173		
RFP300	258	SK-MERC	287	SKO-BKT	285	TH2	207	WO-18	388	WOX-2	388	XC-1500-595-WT-BK	173		
RFP328-DP	258	SK-VEH	284	SKO-BSC	281	TM19	268	WO-18-PK	388	WOX-2-PK	388	XC-1500-595-WT-RD	173		
RFGANULAR	275	SKA-20	288	SKO-CFB	282	TM29	268	WO-19	388	WOX-5	389	XC-1500-595-YL-BK	173		
RF0412	270	SKA20-R	288	SKO-K2R	288	TM58	268	WO-19-VP	388	WOX-9	388	XPS-125-1	173		
RFODP100	263	SKA-20-RESCUE	288	SKO-TRK	284	UNI-UNH 6 P STRAP	319	WO-19-PK	388	WOX-9-PK	388	XPS-125-CONT	173		
RFP100	259	SKA-20-TAA	288	SKO65W	291	UNI-UNH 9 P STRAP	319	WO-20	388	WOX-10	388	XPS-125-CONT-YL-BK	173		
RFP300	259	SKA30	289	SKO-K2	283	UNI-UNH 9 S	319	WO-20-PK	388	WOX-10-PK	388	XPS-187-1	173		
RFP314P	259	SKA30-R	289	SKO-LT	293	UNI-UNH 12 P	319	WO-24	388	WOX-18	388	XPS-187-CONT	173		
RFP328-DP	259	SKA30TAA	289	SKO-PP	282	UNI-UNH PC STRAPS	319	WO-24-PK	388	WOX-18-PK	388	XPS-187-CONT-YL-BK	173		
RFP500	259	SKA55	290	SKO-SAK	282	UNI-UNH S 6 STRAPS	319	WO-27	389	WOX-23	388	XPS-250-1	173		
RFP1100	258	SKA55-R	290	SKO-SRP	283	UNI-UNI 503 GREEN	319	WO-30	388	WOX-24	388	XPS-250-CONT	173		
RK018A	377	SKA55-TAA	290	SKO-XLT	293	UNI-UNI 503 ORANGE	319	WO-30-PK	388	WOX-31	389	XPS-250-CONT-YL-BK	173		
RK085A	377	SKA55W	290	SKR-ATK	281	UNI-UNI 503 PURPLE	319	WO-31	389	WOX-38	389	XPS-375-1	173		
S3000	288	SKA65	291	SKR-PP	282	UNI-UNI 503 RED	319	WO-31-PK	389	WOX-38-PK	389	XPS-375-CONT	173		
S3100-W	30	SKA65-R	291	SM681A	378	UNI-UNI 503 WHITE	319	WO-33	389	WOX-46	388	XSL-11-427	174		
S3100W-ARC-KIT	72	SKA65TAA	291	SM682A	378	UNI-UNI 503 YELLOW	319	WO-34	389	WOX-47	388	XSL-17-427	174		
S3100W-BWSSFID	30	SKA65W	291	SM793E	554	UNI-UNI 504 YELLOW	319	WO-34-PK	389	WOX-49	388	XSL-18-427	174		
S3100W-GEN-KIT	73	SKA-95	292	SP818V	500	UNI-UNI BLANK	319	WO-35	388	WOX-57	389	XSL-19-427	174		
S3100W-GHS-KIT	73	SKA95-R	292	SP184L	500	UNI-UNI BLUE	319	WO-35-PK	388	WSLO	227	XSL-21-427	174		
S3100W-LEAN-KIT	72	SKA-ATK	281	SP430D	413	UNI-UNI GREEN	319	X-7-422	389	X-7-422	389	XSL-21-427-YL-BK	174		
S3100W-PIPE-KIT	73	SKA-ATK-TAA	281	SPC10	273	UNI-UNI ORANGE	319	X-7-498	389	X-7-498	389	XSL-23-427	174		
S3100W-SAFE-KIT	73	SKA-BKTACID	286	SPC50	261	UNI-UNI PURPLE	319	X-11-498	389	X-11-498	389	XSL-23-427-YL-BK	174		
SB-1226	278	SKA-BSC	281	SPC100	261	UNI-UNI RED	319	X-11-499	389	X-11-499	389	XSL-29-427	174		
SB-1236	278	SKA-BKTBASE	286	SPC105	261	UNI-UNI WHITE	319	X-17-422	389	X-17-422	389	XSL-30-427	174		
SC-4	279	SKA-BKT-TAA	285	SPC150	261	UNI-UNI YELLOW	319	X-17-428-SV-BK	388	X-17-428-SV-BK	388	XSL-31-427	174		
SC-3000	279	SKA-CFB	282	SPC152	261	UNI-UNI503 B.	319	X-17-483	388	X-17-483	388	XSL-31-427-YL-BK	174		
SC-ACC	279	SKA-PP-TAA	282	SPC200	261	UXT15P	257	X-18-498	388	X-18-498	388	XSL-32-427	174		
SC-Cabinet	279	SKA-SRP	283	SPC300	261	UXT100	257	X-19-422	388	X-19-422	388	XSL-33-427	174		
SC-Cabinet-HF	279	SKA-TRK	284	SPC500	261	UXT200	257	X-19-498	389	X-19-498	389	XSL-34-427	174		
SC-Cabinet-OF	279	SKA-BKT	285	SPC510	272	UXT300	257	X-20-428-SV-BK	389	X-20-428-SV-BK	389	XSL-96-427	174		
SC-Cabinet-UF	279	SKA-K2	283	SPC518	272	UXT30DP	257	X-20-483	388	X-20-483	388	XSL-102-427	174		
SC-Cart	279	SKA-K2R	283	SPC810	272	V1A0E1A	499	X-21-498	388	X-21-498	388	XSL-103-427	174		
SC-Cart-HF	279	SKA-LT	293	SPC818	272	V1CP45A	501	X-23-498	388	X-23-498	388	XSL-115-427	174		
SC-Cart-OF	279	SKA-PP	282	SPC1900	273	V1DS24A	499	X-24-428-SV-BK	388	X-24-428-SV-BK	388	XSL-116-427	174		
SC-Cart-UF	279	SKA-SAK	282	SPC5510	272	V1EP24A	499	X-29-422	388	X-29-422	388				
SC-DP2	277	SKA-XLT	293	SPC-ACID	275	V1ESG1G	499	X-29-428-SV-BK	388	X-29-428-SV-BK	388				
SC-DP4	277	SKCH-20	288	SPC-BASE	275	V1EW03A	499	X-30-422	388	X-30-422	388				
SC-DPR	277	SKCH-55	290	SPCUN510	272	V1EWG1G	499	X-30-428-SV-BK	388	X-30-428-SV-BK	388				
SC-MB	279	SKCH-95	292	SPCUN810	272	V1FE15A	500	X-31-498	388	X-31-498	388				
SC-SD2	277	SKCH-BKT	285	SPCUN1019	265	V1FEG1G	500	X-61-483	388	X-61-483	388				
SCAF-STH132	321	SKCH-PP	282	SPCUN1113	265	V1FHG1G	500	X-84-499	388	X-84-499	388				
SCAF-STH132A	321	SKH-20	288	SPCUN1719	265	V1FL15A	499	X-103-498	388	X-103-498	388				
SCAF-STH 132BLA-FG	321	SKH-20-RESCUE	288	SPCUN3800	265	V1LS01A	500	X-130-499	389	X-130-499	389				
SCAF-STH 146BLA-FG	321	SKH30	289	SR100	262	V1ME02A	501	X-132-422	389	X-132-422	389				
SCAF-STH 132 FR	321	SKH55	290	SR3600	262	V1MS03A	501	X-162-498	389	X-162-498	389				
SCAF-STH 132 SP	321	SKH55W	290	SR3625	262	V1PH02A	501	X-162-499	388	X-162-499	388				
SCAF-STH146	321	SKH65	291	SRP75P	257	V1RR02A	501	X-163-498	388	X-163-498	388				
SCAF-STH 153	321	SKH65W	291	SRP100	257	V1RR45A	501	XC-240-498	388	XC-240-498	388				
SCAF-STSI 310 STD	321	SKH-95	292	SRP200	257	V1SR03A	501	XC-318-498	388	XC-318-498	388				
SCAF-STSI 311	321	SKH-95W	292	SRPH75P	265	V1SS03A	501	XC-375-422	388	XC-375-422	388				
SCAF-STSI 539	321	SKA-95W	292	SRPH100	265	V1SSG4G	501	XC-375-498	388	XC-375-498	388				
SCAF-STSI593	321	SKH-ATK	281	SRPH200	265	V1SWG4G	501	XC-375-499	388	XC-375-499	388				
SCAF-STSI594	321	SKH-BKT	285	SRP075P	263	V1T0G1G	501	XC-475-422	388	XC-475-422	388				
SCAF-STSI 601	321	SKH-CFB	282	SRP0100	263	V1TS024A	501	XC-500-499	388	XC-500-499	388				
SCAF-STSI 602	321	SKH-K2	283	SRP0200	263	V1WH45A	501	XC-500-595-CL-BK	388	XC-500-595-CL-BK	388				
SCAF-STSI 629	321	SKH-K2R	283	SSTAG-11010-7316	338	V1W002A	501	XC-500-595-BL-WT	388	XC-500-595-BL-WT	388				
SCAF-STSI 639	321	SKH-PP	282	SSTAG-11013-7316	338	V1W045A	501	XC-500-595-GN-WT	388	XC-500-595-GN-WT	388				
SCAF-STSI 640	321	SKH-SAK	282	SSTAG-7010-7316	338	V2E01A	499	XC-500-595-OR-BK	388	XC-500-595-OR-BK	388				
SCAF-STSI 681	321	SKH-SRP	283	SSTAG-7013-7316	338	V2MS24A	501	XC-500-595-RD-WT	388	XC-500-595-RD-WT	388				
SCAF-STSI 694	321	SKH20-R	288	SSTAG-9010-7316	338	V2SS24A	501	XC-500-595-WT-RD	388	XC-500-595-WT-RD	388				
SCAF-STSI 708	321	SKH30-R	289	SSTIE-127-7316	338	V3EW03A	499	XC-750-499	388	XC-750-499	388				
SCAF-STSI 772	321	SKH55-R	290	SSTIE-150-7316-HD	338	V3FE15A	499	XC-750-595-CL-BK	388	XC-750-595-CL-BK	388				
SCAF-STSI751	321	SKH65-R	291	SSTIE-201-7316	338	V2MS21A	500	XC-750-595-GR-WT	388	XC-750-595-GR-WT	388				
SCAF-STSI 1042	321	SKH95-R	292	SSTIE-201-7316-HD	338	WKT2	205	XC-750-595-YL-BK	388	XC-750-595-YL-BK	388				
SCAF-STSIIP 501	321	SKMA-20	288	SSTIE-300-7316	338	WKT3	205	XC-750-595-BL-WT	388	XC-750-595-BL-WT	388				
SCAF-STSIW 510	321	SKMA-30	289	SSTIE-300-7316-HD	338	WO-1	389	XC-750-595-CL-BK	388	XC-750-595-CL-BK	388				
SCAF2-STHUSA	321	SKMA-65	291	SSTIE-370-7316	338	WO-1-PK	389	XC-750-595-GN-WT	388	XC-750-595-GN-WT	388				
SCAF2-STHUSAA	321	SKMA-65W	291	SSTIE-370-7316-HD	338	WO-2	388	XC-750-595-OR-BK	389	XC-750-595-OR-BK	389				
SD02M	225	SKMA-95	292	SSTIE-520-7316	338	WO-2-PK	388	XC-750-595-RD-WT	389	XC-750-595-RD-WT	389				
SF-10B00M	274	SKMA-95W	292	SSTIE-520-7316-HD	338	WO-3	388	XC-750-595-WT-BK	389	XC-750-595-WT-BK	389				
SF-20	274	SKM-LT	293	SSTIE-840-7316-HD	338	WO-4	389	XC-750-595-WT-RD	388	XC-750-595-WT-RD	388				
SF-5B00M	274	SKM-XLT	293	SSTIE-840-7316-HD	338	WO-4	389	XC-750-595-YL-BK	388	XC-750-595-YL-BK	388				
SF-7	274	SKO-20	288	SSTIEC-201-7316	338	WO-5	389	XC-1000-422	389	XC-1000-422	389				
SF-JAR	274	SKO-20-RESCUE	288	SSTIEC-362-7316	338	WO-5-PK	389	XC-1000-499	389	XC-1000-499	389				
SF-JAR-CS	274	SKO20-R	288	SSTIEC-370-7316	338	WO-6	389	XC-1000-595-BL-WT	389	XC-1000-595-BL-WT	389				
SH710	579	SKO30-R	288	SSTIEC-520-7316	338	WO-7	388	XC-1000-595-CL-BK	389	XC-1000-595-CL-BK	389				
SH912	579	SKO30	289	STYLUS-3PK	76	WO-9	388	XC-1000-595-GN-WT	389	XC-1000-595-GN-WT	389				
SH1014	579	SKO30-R	289	SW46	270	WO-9-PK	388	XC-1000-595-OR-BK	389	XC-1000-595-OR-BK	389				
		SKO55	290	SXT15P	262	WO-10	388	XC-1000-595-RD-WT	389	XC-1000-595-RD-WT	389				

Product Index

BradyID.com/s36

15-Series Numbers and Letters	398
34-Series Numbers and Letters	399
5S Lean Marking Kit	298
97-Series Numbers and Letters	399

A

Absorbents	248
Accident Prevention Tags	328
Admittance Signs	417
Aisle Marking Tape	300
Aluminum Numbers and Letters	401
Aluminum Utility Panels	401
Aluminum Write-On Tags	334
Ansi Z535 Signs	432
Anti-Slip Floor Tape	302
Arc Flash Labels	384
Arc Flash Services	24
Arc Flash Training Aids	385
Arrow Die-Cuts	301

B

B30- and B33-Series Materials	55
B30- and B33-Series Materials	36
B30-Series Ribbons	75
B30-Series Ribbons	74
B30-Series Starter Kit	73
Badge	312
Badge Holder	312
Barricade Tape	304
BatteryBlock Cable Lockout	228
BBP35 Color Printer	34
BBP35 Color Printer Materials	36
BBP35 Ribbons	74
BBP37 Color and Cut Printer	34
BBP37 Color and Cut Printer Materials ..	36
BBP37 Ribbons	74
BBP85 Label Materials	82
BBP85 Print Ribbons	83
BBP85 Sign and Label Printer	76
Benchtop Printer Comparison	26
Benchtop Printers	26
Bilingual Signs	440
Biohazard Labels	303
Biohazard Signs	445
Biohazard Tape	303
Biohazard Waste Bags	303
Blank Manila Tags	334
Blank Signs	446
Blank Sign Rigid Panels	89
Blank Tags	334
Blind Flange Lockout	210

BMP21-Plus Materials	106
BMP21-Plus Printer	104
BMP41 Materials	111
BMP41 Printer	108
BMP41 Supply Kit	108
BMP51 Materials	120
BMP51 Printer	114
BMP51 Supply Kits	125
BMP53 Materials	116
BMP61 Materials	134
BMP61 Print Ribbons	150
BMP61 Printer	128
BMP71 Materials	164
BMP71 Print Ribbons	170
BMP71 Printer	152
Brady Workstation Software	178
Bradycone Warning Cones	307
Bradyglo Marking Tape	303
Bradyglo Numbers and Letters	400
BradyJet J2000 Ink	84
BradyJet J2000 Materials	85
BradyJet J2000 Printer	84
BradyJet J5000 Ink	88
BradyJet J5000 Materials	88
BradyJet J5000 Printer	86
Bradylink Posts and Chain	306
BradyPrinter i3300	32
BradyPrinter i3300 Materials	36
BradyPrinter i3300 Ribbons	74
BradyPrinter M611 Accessories	126
BradyPrinter M611 Materials	130
BradyPrinter M611 Print Ribbons	150
BradyPrinter M611 Printer	126
BradyPrinter S3000	28
BradyPrinter S3000 Materials	36
BradyPrinter S3000 Ribbons	74
BradyPrinter S3100	30
BradyPrinter S3100 Materials	36
BradyPrinter S3100 Ribbons	74
Braille Signs	447
Brass Valve Tags	339
BrightSorb Absorbents	264
Butterfly Valve Lockouts	210

C

Cabinet Label	394
Cable Lockout Kit	238
Cable Lockouts	208
Cable Padlocks	208
Carbon Dioxide Signs	460
Chain	341
Chain Lockout Kit	238

Chemical Absorbents	265
Chemical Signs	455
Chemical Signs Prop 65	461
Chemical tag	324
Circuit Breaker Lockout Guide	214
Circuit Breaker Lockouts	220
Collapsible Gate Valve	211
Color-Coded Lock-On Tags	334
Color-Coded Plasti-Tags	334
Concealed Carry / No Fire Arms Signs ..	521
Conduit and Voltage Labels	386
Confined Space Manhole Cover	468
Confined Space Services	25
Confined Space Signs	467
Confined Space Tags	323
Construction Site Signs	469
Container Label	395
Conveyor Labels	387
Custom GHS labels	373
Custom Pipe Markers	360
Custom Signs	582
Custom Tank and Vessel Signs	583
Custom Toughstripe Tape	296
Custom Valve Tags	337
Cylinder Status Tags	324

D

Directional Flow Arrow Tape	358
Dispensers	314
Door Signs	470
Dot Die-Cuts	301
DOT Placard Frames	465
DOT Placard Signs	464
Drum Cover Absorbents	271
Duct Markers	353

E

E-Vehicle Parking Signs	565
Electrical Hazard Signs	474
Electrical Lockout Tagout Kits	233
Electrical Lockouts	219
Energy Source Tags	206
Entry Tag	323
Evacuation Muster Signs	484
Exit and Directional Signs	477
Exit Running Man	482

F

Facility Marking Tape	294
Fire Extinguisher Labels	395
Fire Extinguisher Tag	324

Fire Safety Signs..... 489
 First Aid Signs 493
 Flag Style Blind Tag..... 325
 Flagging Tape..... 305
 Floor Signs..... 496
 Floor Stands 308
 Floor Tape..... 295
 Floor Tape Applicator 295
 Food and Beverage Pipe Markers 350
 Footprint Die-Cuts 301
 Forklift Tag 322
 Funny Signs..... 498
 Fuse Lockout..... 224

G

Gas and Air Lockouts..... 225
 Gas Cylinder Labels 393
 Gauge Marking Labels..... 397
 GHS 362
 GHS Poster..... 369
 GHS Pre-Printed Labels 372
 GHS Training 368
 GHS Training Aids 369
 GHS Write-On Labels 371
 Globalmark Accessories 92
 Globalmark Materials 93
 Globalmark Printer Ribbons 99
 Glow Exit Signs..... 481
 Glow Numbers and Letters 400
 Granular Absorbents 275
 Group Lock Boxes..... 198

H

Handicapped Parking Signs 566
 HandySorb Mop System 271
 Hard Hat Emblem Labels 397
 Hasp 197
 Hazardous Material Shipping Labels ... 376
 Hazardous Waste Labels 374
 High Performance Pipemarkers 356
 High Visibility Signs 499
 Hospital Signs 502

I

i3300 Printer 32
 IDXPART Accessories 172
 IDXPART Materials 172
 IIAR Component Marker 345
 IIAR Pipe Banding Tape 358
 IIAR Pipe Markers..... 345

IMO Signs..... 485
 Inkjet Printers..... 84
 Inspection and Material Control Tags... 326
 Inspection Labels..... 389
 Inspection Tags 318
 Inspection Timer..... 318
 ISO Prohibition Labels..... 386
 ISO Warning Labels 386
 Isolation Blind Tags 325
 Isolation tag..... 324

J

J2000 Inkjet Printer..... 84
 J5000 Inkjet Printer..... 86
 Joint Flange tag..... 324

L

Labelizer Plus Materials 101
 Ladder Tag 322
 Laminator..... 89
 Lanyard 312
 Link360 Lockout Procedure Software... 179
 Lock and Tag Carrier..... 201
 Lock Boards 246
 Lock Boxes..... 200
 Lockout Hasps 197
 Lockout Procedures 182
 Lockout Stations 245
 Lockout Tagout..... 180
 Lockout Tagout Kits 241
 Lockout Tagout Poster..... 551
 Lockout Tagout Services 23
 Lockout Tagout Signs 504
 Lockout Tagout Training 185
 Lockout Tags 203

M

Machine / Equipment Labels..... 390
 Machine and Operational Signs..... 513
 Machine Labels..... 391
 Magnetic Numbers..... 400
 Magnets (Write-On)..... 301
 Maintenance Signs..... 518
 Marine Absorbents 273
 Marking Tape..... 300
 Mat and Rug Absorbents 266
 Medical Pipe Marker 353
 Metal Write-On Tags 334
 Metal-Ball Seal..... 310
 Micro Tag..... 320

Miniature Circuit Breaker Lockout 222
 Minimark Label Materials 90
 Minimark Printer Ribbon 91
 Mirror 309
 Multi tag..... 322

N

Nano tag..... 319
 NetDoc Software 179
 No Cellular Phones Signs..... 521
 No Fire Arms Signs / Concealed Carry 521
 No Smoking Signs 523
 Number and Letters 398
 Nylon Straps..... 341

O

Oil Only Absorbents 261
 Outdoor Numbers and Letters 401

P

Padlock Labels..... 196
 Padlock Storage 201
 Padlocks..... 186
 Padlocks - Aluminum..... 195
 Padlocks - Nylon 192
 Padlocks - Nylon Lock Tag Kit..... 193
 Padlocks - SafeKey 191
 Padlocks - SafeKey Lock Labels..... 190
 Padlocks - SafeKey Tag Kit 191
 Padlocks - Steel..... 194
 PaintStripe Stencils..... 299
 Parking Permit 313
 Parking Signs 560
 Pavement Tape..... 581
 Pendant Control Safety Cover..... 226
 Pennant Flags..... 305
 Personal Hygiene Signs 528
 Personal Protection (PPE) Signs 530
 Pillow Absorbents..... 271
 Pipe Banding Tape 358
 Pipe Marker Arrows 358
 Pipe Marker-TO-GO..... 352
 Pipe Markers 342
 Pipe Markers - Self-Adhesive 346
 Pipe Markers - Spanish 349
 Pipe Markers Accessories..... 359
 Plastic Seals 310
 Plug Lockouts..... 229
 Porta-Pack Voltage Labels 387

Product Index

BradyID.com/s36

Portable Printer Comparison	102
Post Driver	579
Power Cable Lockout	228
Pre-Printed Facility Labels.....	384
Pre-printed KVA Markers.....	401
Printers - Benchtop.....	26
Printers - Portables.....	102
Procedure Accessories	184
Production Tags.....	327
ProLock Cable Lockout.....	209
Prop 65 Signs	461
Pull-Tite Seals	311
Push Button Covers.....	226

Q

Quik-Align Numbers and Letters.....	400
Quality Control Labels	389
QuickSleeve Applicator.....	63

R

Radiation and Laser Signs	542
Railroad Traffic Signs.....	568
Re-Form Absorbents	259
Recycle and Environment Signs	544
Red Tag Program	332
Red Tag Signs	332
Red Tags	332
Reflective Tape	300
Restroom Signs	545
Right To Know Labels.....	374
Rigid Sign Panels	89
Rigid Tag Panel	92
Ring-Loc Drum Seal	311
RipTag Rolls.....	204
Road Construction Signs.....	569
Roll-Form Pipe Marker.....	351

S

S-Hooks.....	341
S3000 Printer.....	28
S3100 Printer.....	30
SafeKey Lockout Boards.....	246
SafeKey Lockout Kits	230
SafeKey Lockout Padlocks.....	188
SafeKey Lockout Stations.....	243
Safety Banners	550

Safety Information Centers.....	378
Safety Posters.....	552
Safety Sign Slider Boards.....	546
Safety Sign Sliders	547
Safety Signs.....	402
Safety Slogan Signs	553
Safety Stop Station	317
Scaffolding Tags.....	320
Scoreboard Signs.....	554
Seals.....	310
Security.....	310
Security Signs.....	557
Self-Laminating Tags	333
Semiconductor Pipe Marker.....	353
Seriesystem Markers	401
Services.....	22
Severe Weather Directional Signs	479
Shadowboard Tape	300
Shipping / Receiving Signs	570
Sign Accessories.....	578
Sign Fasteners.....	580
Sign Panels - Rigid	38
Sign Posts.....	580
Signs Material Guide.....	408
SlimView Group Lock Box	198
Slow Moving Vehicle Sign	580
Smoking Area Signs	527
Snap-On Pipe Marker.....	354
SOC Absorbents	270
Software.....	176
SPC Absorbents	248
Spill Containment	276
Spill Kits.....	281
Stainless Steel Tags and Ties.....	338
Strap-On Pipe Marker.....	354

T

Tag Accessories.....	207
Tag Storage Center	207
Taglock Lockouts.....	219
Tags - Facility.....	318
Tags - Lockout	202
Tape Applicator	295
Tape - Facility Marking	295
Temporary Signs	558
Tensabarrier Barricades	309
Terminal Block Lockout	224
Timer.....	318

TLS2200 Materials.....	129
TLS2200 Print Ribbons.....	150
Toughstripe Die-cut Shapes.....	296
Toughstripe Floor Signs.....	297
Toughstripe Max Tape	295
Toughstripe Numbers and Letters.....	298
Toughstripe Pre-Spaced Tape.....	296
Toughstripe Tape	295
ToughStripe Tape Applicator	295
ToughWash Cable Ties.....	559
ToughWash Harsh Washdown Signs....	559
ToughWash Harsh Washdown Tags....	204
Traffic Barrels.....	581
Traffic Cones.....	580
Traffic Control Signs	574
Transfer Tape	39
Transformer Labels.....	387
Transparent Gate Valve	211

U

U-Channel Posts.....	580
Ultra-Compact Lock Box.....	198
Underground Warning Tape.....	305
Uni-tag.....	319
Universal Absorbents.....	256

V

Valve Lockout Kits	237
Valve Lockouts	213
Valve Tag Fasteners	341
Valve Tags	340
Versaprinter Label and Sign Maker.....	100
Visual Workplace.....	294

W

Wall Switch Lockout	227
Warning Stakes	307
Warning Tape	300
Workstation Software.....	176
Wristband	312
Write-On Inspection Labels.....	389
Write-On Magnetic Labels.....	397

There's more online at

BradyID.com/s36

Design-Your-Own Padlock Online **new**

Create a custom SafeKey padlock with the options you need, including engraving, in one easy-to-use online tool.

Design-Your-Own Signs Online

Custom signs in no time! Quickly design, proof and order your custom safety signs with this convenient online tool.



We identify and protect premises, products and people.

For more information or to learn more about our innovative products, visit BradyID.com or call 1-888-272-3946.



Y4824855 MS4824855

© 2019 Brady Worldwide Inc. ALL RIGHTS RESERVED

USA
Customer Service: 1-888-272-3946
Inside Sales: 1-888-311-0775
BradyID.com

Canada
Customer Service: 1-800-263-6179
BradyCanada.ca

Mexico
Customer Service: 1-800-262-7777
Inside Sales: 1-800-262-7777 ext 177
BradyLatinAmerica.com

